

# MERCUISER VOLVO OMC YANMAR

INTRA-FUERABORDA • OUT-INBOARD  
ENTRO-FUORIBORDO • IN-BORD HORS-BORD

2023  
2024

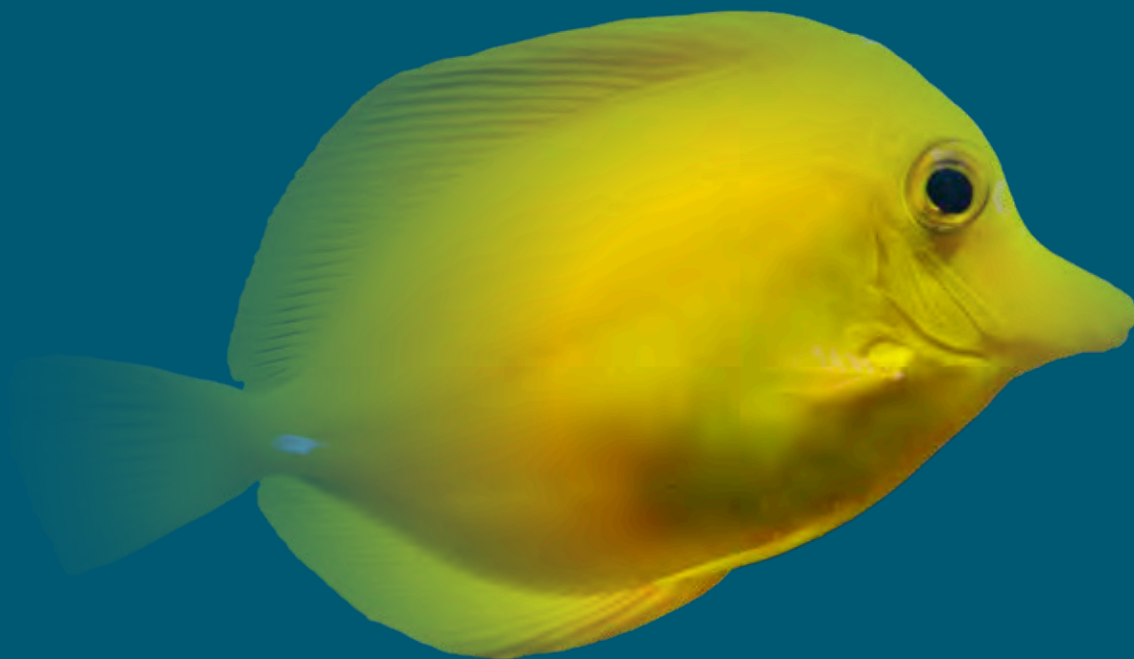





# MERCRUISER VOLVO OMC YANMAR

INTRA-FUERABORDA • OUT-INBOARD  
ENTRO-FUORIBORDO • IN-BORD HORS-BORD

2023  
2024



## IMPORTANTE

LOS PRODUCTOS QUE APARECEN EN NUESTROS CATALOGOS SON VÁLIDOS Y COMPATIBLES CON LOS MOTORES Y TRANSMISIONES DE LAS MARCAS ORIGINALES QUE APARECEN EN CADA SECCIÓN. EN ALGUNOS CASOS TAMBIÉN SUMINISTRAMOS RECAMBIOS ORIGINALES. ESTA INFORMACIÓN APARECE CON LA REFERENCIA EN EL MOMENTO DE CONFIRMAR EL PEDIDO POR NUESTRA WEB. LA IMÁGENES AQUÍ CONTENIDAS PUEDEN NO CORRESPONDER CON TOTAL PRECISIÓN AL PRODUCTO SUMINISTRADO. RECAMBIOS MARINOS, S.L.U. SE RESERVA EL DERECHO DE ANULAR O CAMBIAR PRODUCTOS SIN PREVIO AVISO.

## IMPORTANT

THE PRODUCTS THAT APPEAR IN OUR CATALOGS ARE VALID AND COMPATIBLE WITH THE MOTORS AND TRANSMISSIONS OF THE ORIGINAL BRANDS THAT APPEAR IN EACH SECTION. IN SOME CASES WE ALSO SUPPLIED ORIGINAL SPARE PARTS. THIS INFORMATION APPEARS WITH THE REFERENCE AT THE TIME OF CONFIRMING THE ORDER BY OUR WEB. IMAGES CONTAINED HERE MAY NOT CORRESPOND WITH TOTAL ACCURACY TO THE PRODUCT SUPPLIED. RECAMBIOS MARINOS, S.L.U. RESERVES THE RIGHT TO CANCEL OR CHANGE PRODUCTS WITHOUT PRIOR NOTICE.

## IMPORTANTE

I PRODOTTI CHE COMPAGNONO NEI NOSTRI CATALOGHI SONO VALIDI E COMPATIBILI CON I MOTORI E LE TRASMISSIONI DEI MARCHI ORIGINALI CHE APPAIONO IN OGNI SEZIONE. IN ALCUNI CASI ABBIAMO FORNITO ANCHE RICAMBI ORIGINALI. QUESTA INFORMAZIONE RISULTA CON IL RIFERIMENTO AL MOMENTO DELLA CONFERMA DELL'ORDINE DA PARTE DEL NOSTRO WEB. LE IMMAGINI QUI CONTENUTE POTREBBERO NON CORRISPONDERE ESATTAMENTE AL PRODOTTO FORNITO. RECAMBIO MARINOS, S.L.U., SI RISERVA IL DIRITTO DI CANCELLARE O MODIFICARE I PRODOTTI SENZA PREAVVISO.

## IMPORTANT































LES PRODUITS QUI FIGURENT DANS NOS CATALOGUES SONT VALIDES ET COMPATIBLES AVEC LES MOTEURS ET LES TRANSMISSIONS DES MARQUES ORIGINALES QUI SONT PRESENTES DANS CHAQUE SECTION. DANS CERTAINS CAS NOUS FOURNISSONS EGALEMENT DES PIÈCES DE RECHANGE ORIGINALES. CETTE INFORMATION EST MENTIONNÉE AVEC LA REFERENCE SUR NOTRE SITE WEB. LES IMAGES CONTENUES DANS CE DOCUMENT PEUVENT NE PAS CORRESPONDRE AVEC UNE PRECISION TOTALE AU PRODUIT FOURNI. RECAMBIO MARINOS S.L.U. SE RESERVE LE DROIT D'ANNULER OU DE MODIFIER DES PRODUITS SANS PREAVIS.

<b>• MERCUISER CUMMINS</b> REF --> OEM OEM --> REF	<b>96</b> 319 330
<b>• VOLVO</b> REF --> OEM OEM --> REF	<b>340</b> 593 605
<b>• OMC</b> REF --> OEM OEM --> REF	<b>616</b> 700 704
<b>• YANMAR</b> REF --> OEM OEM --> REF	<b>708</b> 776 779
<b>• OTRAS MARCAS   OTHER BRANDS</b> <b>ALTRE MARCHE   AUTRES MARQUES</b> REF --> OEM OEM --> REF	<b>782</b> 861 866
Política de garantía y devolución Warranty and return policy Politica di garanzie e regole per i rest merce Politique de garantie et retour de pièces	<b>869</b>

ÍNDICE accesorios	Accessories TABLE OF CONTENTS	INDICE accessori	INDEX accessoires	
SOPORTES	STANDS	SUPPORTI	SUPPORTS	<b>7</b>
PINTURAS	PAINTS	PITTURE	PEINTURES	<b>11</b>
ANTIFOULING	ANTIFOULING	ANTIFOULING	ANTIFOULING	<b>12</b>
MANTENIMIENTO DEL MOTOR	ENGINE MAINTENANCE	MANUTENZIONE MOTORE	MAINTENACE MOTEUR	<b>13</b>
<b>BARNACLE BUSTER®</b>	<b>BARNACLE BUSTER®</b>	<b>BARNACLE BUSTER®</b>	<b>BARNACLE BUSTER®</b>	<b>16</b>
<b>PERMATEX®</b>	<b>PERMATEX®</b>	<b>PERMATEX®</b>	<b>PRODUITS PERMATEX</b>	<b>17</b>
LUBRICANTES	LUBRICANT	LUBRIFICANTE	HUILE POUR MOTEUR	<b>20</b>
ACCESORIOS Y HERRAMIENTAS DE INSTALACIÓN	ACCESSORIES AND INSTALATION TOOLS	ACCESSORI E ATTREZZI INSTALLAZIONE	ACCESSOIRES ET OUTILS D'INSTALLATION	<b>32</b>
<b>TX MARINE®</b>	<b>TX MARINE®</b>	<b>TX MARINE®</b>	<b>TX MARINE</b>	<b>42</b>
RACORES Y TORNILLERÍA	RACORS & FITTINGS	RACCORDI E VITERIA	RACCORS ET VISERIE	<b>45</b>
SENSORES Y ALARMAS	SENDERS & ALARMS	SENSORE E ALLARMI	SONDES ET ALARMES	<b>46</b>
MANGUERAS	HOSES	TUBO	TUYAUX	<b>46</b>
MANGUERAS Y CODOS DE SILICONA	ENGINE AND ELBOW IN SILICONE	TUBI E GOMITI IN SILICONE	DURITES ET COUDE EN SILICONE	<b>47</b>
LLAVE DE ARRANQUE	IGNITION STARTER SWITCHES	CHIAVE DI AVVIAMENTO	CONTACTEUR À CLÉ	<b>48</b>
IDENTIFICACIÓN DE MOTOR	ENGINES'S IDENTIFICATION	IDENTIFICAZIONE MOTORE	IDENTIFICATION DES MOTEUR	<b>50</b>
MOTORES Y CULATAS GM NUEVOS	MOTORS & CYLINDER GM. NEW	MOTORI ET TESTATE GM NOUVI	MOTEURS ET CULASSES GM NEUFS	<b>52</b>
MOTORES Y CULATAS REMANUFACTURADOS GM & FORD	MOTORS & CYLINDER GM & FORD. REMANUFACTURED	BLOCCHI ET TESTATE GM & FORD RIGENERATI	BLOCS ET CULASSES GM & FORD RECONDITIONNE	<b>59</b>
DESPIECE GM	GM PARTS	PARTE GM	PARTIES GM	<b>64</b>
DESPIECE FORD	FORD PARTS	PARTE FORD	PARTIES FORD	<b>89</b>
index ref	Ref. table	Indice Ref.	Index Réf.	<b>91</b>

ICONOS ICONS ICONE ICONES

	Medida	Measures	Dimensione	Dimension
	Ancho	Width	Larghezza	Largeur
	Alto	High	Alto	Hauteur
	Largo Fondo	Length Depth	Lungo Sfondo	Longueur Profondeur
	Unidades x bolsa	Units x bag	Unità x borsa	Unité x sachet
	Unidades x skinpack	Units x skinpack	Unità x skinpack	Unité x blister
	Caja	Box	Scatola	Carton
	Peso	Weighth	Peso	Poids
	Trabajo seguro	Safe work	Lavoro sicuro	Travailler en sécurité
	Tubo Manguera	Tube	Tubo	Tuyau Durite
	Distancia entre tornillos	Screw space	Distanza tra le viti	Entraxe
	Tornillo	Screw	Vite	Vis
	Rosca	Thread	Filo	Filetage
	Rosca Macho	Male Thread	Filetto maschio	Filetage mâle
	Rosca Hembra	Female thread	Filetto femmina	Filetage femelle
	Electricidad	Power	Elettricità	Electricité
	Eslora	Boat length	Lunghezza imbarcazione	Longueur embarcation
	Mando	Control	Comando	Boitier
	Carga máxima	Max. Load	Caricca massima	Charge maximale
	Flujo Velocidad	Flow Speed	Flow	Vitesse du débit
	Presión	Pressure	Presione	Pression
	Presión máx.	Max. pressure	Presione mass.	Pression max.
	Radio	Radius	Raggio	Rayon
	Entrada	IN	Ingresso	Entrée
	Salida	OUT	Uscita	Sortie
	Capacidad	Capacity	Capacità	Capacité
	Temperatura	Temperature	Temperatura	Température
	Hélice	Propeller	Elica	Hélice
	Cono eje	Hub	Asse conico	Asse conique
	Motor	Motor	Motore	Moteur

	Ánodo	Anode	Anodo	Anode
	Filtro	Filter	Filtro	Filtre
	Elemento filtro	Filter Element	Elemento filtro	Cartouche de filtre
	Llave	Key	Chiave	Clé
	Posiciones llave	Key positions	Chiave, posizione	Clé, positions
	Material	Material	Materiale	Matériel
	Pins	Pins	Pin	Pines
	Cables Terminales	Terminals	Terminali	Bornes
	Junta	Gasket	Guarnizione	Joint
	Piston	Piston	Pistone	Piston
	Aros de piston	Piston ring	Fasce pistone	Segments de piston
	Cojinete	Bearing	Cuscinetto	Roulement
	Impulsor	Impeller	Girante	Turbine
	Tuerca	Nut	Dado	Écrou
	Dientes	Tooth	Denti	Dents
	Estrías	Spline	Scanalatura	Dents
	Polea	Pulley	Pulleggia	Poulie
	Solenide Relé	Solenoid Relay	Relé	Relais
	Conector latiguillo	Trim connectors	Connettori trim	Connecteurs flexible de trim
	Fuelle	Bellow	Cuffia	Soufflet
	Abrazadera	Clamp	Fascetta	Collier
	Cuerpos carburador	Carburetors BBL	Corpi carburatore	Cors carburateur
	Volante	Flywheel	Volante	Volant
	Flotador	Float	Gallegiante	Floteur
	Kit aguja carburador	Inlet needle kit	Kit spillo	Kit pointeau
	Cable	Wire	Cavi	Faisceau
	Centrador bomba aspiración agua	Water pump cross pieces	Centratori pompa aspirazione	Toc d'entrainement de pompe à eau
	Consola bomba agua	Pump console	Tirante per pompa	Support de pompe à eau
	Tope bomba agua	Pump stop	Aletta arresto pompa	Butée de pompe à eau
	PROHIBIDO. No recomendado.	PROHIBITED. Not recommended.	VIETATO. Non è raccomandato.	INTERDIT. Déconseillé.

SOPORTES

STANDS

SUPPORTI

SUPPORTS

**MEGASOPORTE PARA EMBARCACIONES**

Diseñado para adaptarse a la mayoría de configuraciones de casco.  
Ajuste rápido ancho - alto con sistema de bulón.  
Las almohadillas especialmente diseñadas limitan el movimiento de cabeceo (lado a lado) facilitando su posición durante la colocación del barco.  
Se puede ajustar a alturas independientemente para exhibir el barco inclinado.  
Acabado resistente con pintura negra.  
Ruedas de poliuretano para casi todo tipo de superficies planas, incluidas baldosas y mármol.

**MEGASUPPORT FOR BOATS**

Designed to fit most helmet configurations.  
Quick width-to-height adjustment with bolt system.  
Specially designed pads limit pitching movement (side to side) making it easier to position the boat during positioning.  
Can be adjusted to independent heights to display the boat at an incline.  
Durable black painted finish.  
Polyurethane wheels for almost any flat surface, including tile and marble.

**MEGASUPPORTO PER LE IMBARCAZIONE**

Progettato per adattarsi alla maggior parte delle configurazioni di casco.  
Regolazione rapida da larghezza ad altezza con sistema a bulloni.  
I cuscinetti appositamente progettati limitano il movimento di beccheggio (da un lato all'altro) facilitando il posizionamento dell'imbarcazione.  
Può essere regolato ad altezze indipendenti per visualizzare l'imbarcazione in pendenza.  
Finitura resistente verniciata in nero.  
Ruote in poliuretano per quasi tutte le superfici piane, comprese piastrelle e marmo.

**MÉGASUPPORT POUR LES BATEAUX**

Conçu pour s'adapter à la plupart des configurations de casques.  
Réglage rapide de la largeur à la hauteur grâce au système de boulons.  
Des patins spécialement conçus limitent le mouvement de tangage (d'un côté à l'autre), ce qui facilite le positionnement du bateau lors de la mise en place.  
Peut être réglé à des hauteurs indépendantes pour afficher le bateau en inclinaison.  
Finition durable en peinture noire.  
Roues en polyuréthane pour presque toutes les surfaces planes, y compris le carrelage et le marbre.

new

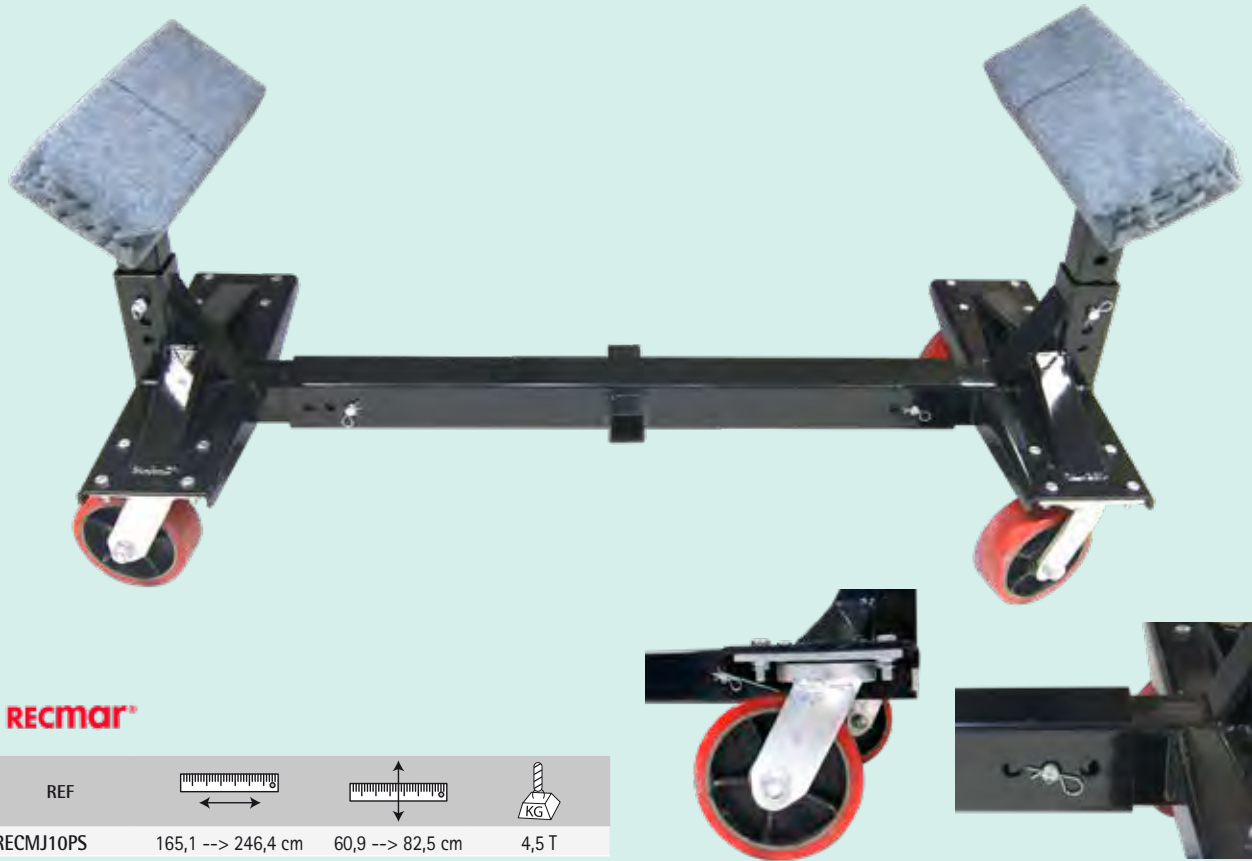

**SOPORTES PARA EMBARCACIONES**

**BOAT STANDS**

**SUPPORTI PER IMBARCAZIONI**

**BERS ROULANT POUR BATEAU**

REF	
RECE36	1.500 kg

**RECMAR®**

REF
RECE36C

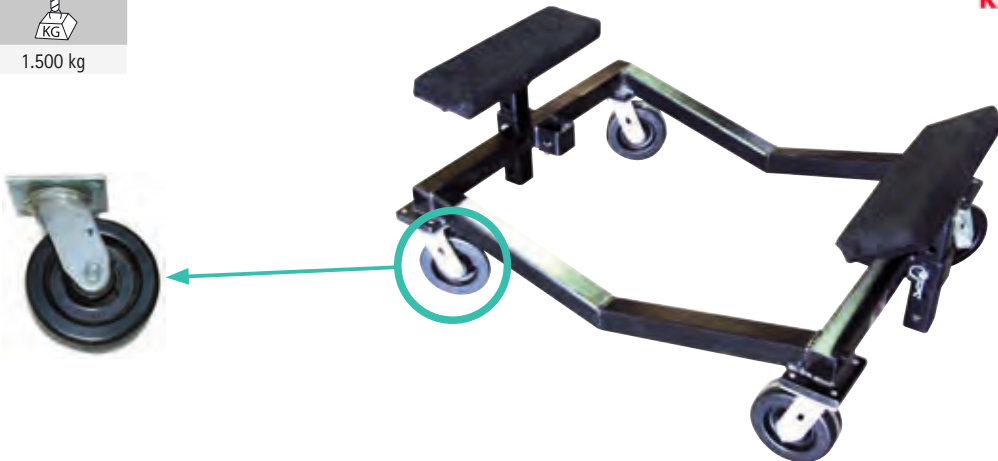

**SOPORTES DESCARGA DE EMBARCACIONES**

**RECH10**  
 Para cargar o descargar embarcaiones de los remolques o cuna.  
 Los remolques pueden entrar y salir de entre los gatos hidráulicos libremente, facilitando su tarea.  
 Levantan embarcaciones de hasta 18 toneladas.  
 Su recorrido de elevación es de 51 cm.  
 Equipado con válvula de bloqueo que permite mantener el barco indefinidamente en la posición deseada.  
 Puede actuar sobre tierra, grava, asfalto o cemento, tanto en la tienda, como en el varadero o exposición.

**BOAT HANDLING JACKS & STANDS**

**RECH10**  
 Work station for bottom repair & cleaning. Trailer rolls in out past jacks, allowing you to take boats on or off trailers easily.  
 Jacks have an auto lock allowing boats to be left on indefinitely.  
 Can be used on dirt, gravel, black top or cement.  
 Can be used anywhere! Shop, yard, showroom.  
 Lifts boats up to 40,000 lbs.

**SUPPORTI SCARICO IMBARCAZIONI**

**RECH10**  
 Per caricare o scaricare imbarcazioni da rimorchi o sostegni.  
 I rimorchi possono entrare e uscire tra i crik idraulici liberamente, facilitando il compito.  
 Solleva imbarcazioni fino a 18 tonnellate.  
 Escursione max di 51 cm.  
 Fornito di valvola di blocco che permette di mantenere la barca nella posizione desiderata per diversi tempi.  
 Può essere usato su terra, ghiaia, asfalto o cemento, come in negozio o in esposizione.

**SUPPORTS DE DÉCHARGE DE BATEAU**

**RECH10**  
 Pour charger ou décharger des bateaux de remorques ou de berceaux.  
 Les remorques peuvent entrer et sortir librement entre les vérins hydrauliques, ce qui facilite leur tâche.  
 Ils lèvent des navires jusqu'à 18 tonnes.  
 Sa course d'élevation est de 51 cm.  
 Equipé d'une valve de blocage qui permet au navire d'être maintenu indéfiniment dans la position souhaitée.  
 Il peut agir sur terre, gravier, asphalte ou ciment, aussi bien en magasin qu'en hangar à bateaux ou en exposition.

REF	INCLUYE	INCLUDED	INCLOSIO	COMPREND
RECH10	Soportes hidráulicos	Jacks	Supporti idraulici	Supports hydrauliques x 4
	REC12 Soportes	Straight arms	Supporti	Supports x 4
	REC15 Soportes inclinados 25 cm	10" drop arms	Supporti inclinati 25 cm	Supports inclinés de 25 cm x 4
	REC20 Soportes asiento barco	4" x 18" contact pads	Supporti appoggi barche	Supports de siège de bateau x 4
RECH10-1/4	Soporte hidráulico	Jack	Supporto idraulico	Support hydraulique 1
	REC12 Soporte	Straight arm	Supporto	Support 1
	REC15 Soporte inclinados 25 cm	10" drop arms	Supporto inclinato 25 cm	Support incliné de 25 cm 1
	REC20 Soporte asiento barco	4" x 18" contact pad	Supporto appoggio barche	Support de siège de bateau 1

**RECMAR®**



REF					
REC12	Soporte plano std.	Straigh support standard	Braccia piatto standard	Support plat standard	83,8 - 132 cm
	1ª posición	1st pin hole	1ª posizione	1ère position	900 kg
	2ª posición	2nd pin hole	2ª posizione	2ème position	1.800 kg
	3ª posición	3rd pin hole	3ª posizione	3ème position	3.000 kg
	4ª posición	4th pin hole	4ª posizione	4ème position	3.600 kg
REC15	Soporte inclinado	Drop arm	Braccia	Support incliné	28 cm = 10"
REC16	Soporte inclinado	Drop arm	Braccia	Support incliné	51 cm = 20"
REC17	Suplemento	Single riser extension	Suplementi	Supplement	12,5 cm = 5"
REC18	Suplemento	Single riser extension	Suplementi	Supplement	25 cm = 10"
REC19	Soporte con goma	Large pad	Braccia contatto	Support	6.800 kg + 76 cm = 30"
REC20	Soporte con goma	Large pad	Braccia contatto	Support	- 6.800 kg 45.7 cm = 18"

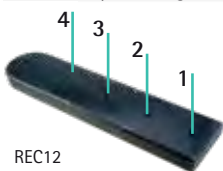

REF				
RECNSCYL	Pistón	Piston	Pistone	Vérin
RECKFW	Rueda hidráulica	Hydraulic jack FT-Wheel	Ruota idraulica	Roue





## SOPORTES PARA COLAS

### RECJO6HD

Carro con gato hidráulico para la instalación de todo tipo de colas. Permite desmontar o montar colas, una sola persona. Especialmente útil en embarcaciones con plataforma integrada. Construido con brazos extra largos de sujeción y base con 4 ruedas neumáticas. Gran capacidad de elevación para colas de peso extra. También en colas de doble hélice. Varias regulaciones.

REF

RECJO6HD

**RECMAR**

## STANDS FOR STERN DRIVES

### RECJO6HD

Stern drive installer. Works in all makes and models. Allows one man to remove and install stern drives. Especially helpful on boats with integrated swim platforms. Built with extra long clamping arms and wheel base, plus heavyduty lifting capacity for those extra heavy drives. Also works great on dual prop drives. Unique low cost shop tool. 4 air tires allow for rugged yard use.

## SUPPORTI PER PIEDI

### RECJO6HD

Carro con crick idraulico per l'installazione di tutti i tipi di piedi. Permette ad una persona di smontare o montare i piedi da solo. Specialmente utile nelle imbarcazioni con piattaforma integrata. Costruito con larghi bracci di fissaggio e una base con 4 ruote pneumatiche. Grande capacità di sollevamento per piedi con peso extra. Anche per piedi con doppia elica. Varié regolazioni.

## SUPPORTS D'EMBASES

### RECJO6HD

Chariot avec vérin hydraulique pour l'installation de tous types d'embase. Il permet à une seule personne de démonter ou de monter des embases. Particulièrement utile dans les bateaux avec plate-forme intégrée. Construit avec des bras de support extra longs et une base avec 4 roues pneumatiques. Grande capacité de levage pour des embases de poids important. Egalement en arbre double hélice.



REF

REF				
RECKOCYL	Pistón	Piston	Pistone	Vérin
RECKRW	Rueda completa	Hydraulic jack RE-Wheel	Ruota completa	Roue complète
RECKFW	Rueda hidráulica	Hydraulic jack FT-Wheel	Ruota idraulica	Roue
RECJO10	Suplemento 25 cm	Suplement 10"	Supplemento 25 cm	Rallonge de 25 cm
RECHANDLEJO6HD	Maneta	Handle	Maniglia	Poignée
RECSRINGJO6HD	Muelle	Spring	Molla	Ressort



RECKOCYL



RECJO10



RECKRW

RECKFW



RECHANDLEJO6HD

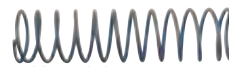

RECSRINGJO6HD

### RECWS3

SopORTE trabajo reparación todo tipo de colas y motores fueraborda.

REF

RECWS3

**RECMAR**

### RECWS3

Work station. Holds all kind of drives and outboard engines.

### RECWS3

Supporto lavoro per riparare tutti i tipi di piedi e motori fuoribordo.

### RECWS3

Support pour les travaux de réparation de tous types d'embase et de moteurs hors-bord.



**RECSR9**  
Soporte para 9 colas.  
Mantiene el taller limpio y organizado.  
Protege las colas de golpes y daños.

**RECSR9**  
Holds 9 stern drives.  
Keeps shop looking neat and clean.  
Protects drives from being cratched  
and damaged.

**RECSR9**  
Supporto per 9 piedi.  
Mantiene l'officina pulita e  
organizzata.  
Protegge i piedi dai colpi e dai danni.

**RECSR9**  
Charriot pour le stockage de 9  
embases.  
Maintient l'atelier propre et organisé.  
Protège les pieds d'embase des chocs  
et des dommages.

REF  
RECSR9  
**RECMAR®**



REF  
RECSR9WHEEL



**SOPORTES PARA MOTORES**

**STANDS FOR ENGINES**

**SUPPORTI PER MOTORI**

**SUPPORTS MOTEUR**

Soporte de trabajo giratorio 360° con  
ruedas. Para todo tipo de motores;  
GM, FORD, VOLVO.  
Ideal para reparaciones completas.

Allow engine to be rotated 36 0°.  
Adjustable mounting plate will  
accommodate all engine types.

Carrello supporto motore, permette  
il movimento per 360° utile per  
lavorazioni in coppa.  
Fornito di ruote piene, può montare  
tutti i blocchi GM, FORD, VOLVO.

Support de travail rotatif à 360 ° avec  
roues. Pour tous types de moteurs;  
GM, FORD, VOLVO. Idéal pour des  
réfections complètes.

REF  
RECTOOL1  
**RECMAR®**



**YARES2**  
Soporte trabajo giratorio 360° con  
ruedas. Para todo tipo de motores:  
GM, FORD, VOLVO.  
Ideal para reparaciones completas.  
Se le pueden adaptar los soportes  
referencias YARCHA para GM y  
YARFHA para FORD y probar motores  
en funcionamiento.

**YARES2**  
360° rotating work support with  
wheels. For all types of engines: GM,  
FORD, VOLVO.  
Ideal for complete repairs. You can  
adapt the YARCHA reference supports  
for GM and YARFHA for FORD and test  
running engines.

**YARES2**  
Supporto lavoro girevole 360° con  
ruote.  
Per tutti i tipi di motori: GM, FORD,  
VOLVO.  
Ideale per riparazioni complete.  
Si possono adattare i supporti di  
riferimento YARCHA per GM e YARFHA  
per FORD e provare i motori in  
funzione.

**YARES2**  
Support de travail rotatif à 360° avec  
roues. Pour tous types de moteurs :  
GM, FORD, VOLVO.  
Idéal pour des réparations complètes.  
Vous pouvez adapter les supports de  
référence YARCHA pour GM et YARFHA  
pour FORD et tester les moteurs en  
cours d'utilisation.

REF  
YARES2 GM, FORD, VOLVO  
YARFHA Kit FORD  
YARCHA Kit GM





# PINTURAS

# PAINTS

# PITTURE

# PEINTURES

## PINTURA EN SPRAY

Sprays de pintura con los colores originales para retoque de los motores, interiores, intra-fueraborda y colas fueraborda más usuales. Capacidad: 400 ml.

## SPRAY PAINT

























Spray paints with the original colors for maintenance and painting and outboard marine engine as well as stern-drives units. Bottle: 400 ml.

## PITTURE SPRAY

Vernice spray con i colori originali per ritocchi dei motori entro-bordo, entro-fuoribordo ed i piedi. Capacità: 400 ml.

## PEINTURE EN SPRAY

Peinture en aérosol aux couleurs originales pour la retouche des moteurs in-bord et les embases les plus courantes. Capacité: 400 ml.

REF		COLOR	COLOUR	COLORE	COULEUR
GS90019		Barniz transparente	Clear Varnish	Vernice trasparente	Vernis transparent
GS90037	Evinrude	 Azul XP	Blue XP	Blu XP	XP bleu
GS90030	Johnson	 Blanco (1972-90)(1993+)	White (1972-90)(1993+)	Bianco (1972-90) (1993+)	Blanc (1972-90)(1993+)
GS90026	Johnson	 Blanco (1981-83)	White (1981-83)	Bianco (1981-83)	Blanc (1981-83)
GS90039	Johnson	 Plata metalizado	Silver Metal	Argento metallizzato	Argent métallisé
GS90040	Mariner	 Gris	Grey	Grigio	Gris
GS90002	Mercury Mercruiser	 Negro	Black	Nero	Noir
GS90006	Caterpillar	 Amarillo	Yellow	Giallo	Jaune
PS111028	Cummins	 Blanco	White	Bianco	Blanc
PS111047	Cummins	 Blanco hueso	White bone	Bianco osso	blanc os
PS111035	Detroit Diesel	 Plateado	Silver	Argento	Argent
PS111091	IVECO / AIFO	 Rojo	Red	Rosso	Rouge
PS114704	NanniDiesel	 Azul Metal	Blue Metal	Blu Metallizzato	Bleu métal
PS114709	OMC	 Cola Cobra	Cobra Stern-drive	Piede Cobra	Embase Cobra
PS114699	Perkins	 Verde Metal	Green Metal	Verde Metallizzato	Vert métallisé
PS114700	Perkins	 Azul (1983+)	Blue (1983+)	Blu (1983+)	Bleu (1983+)
PS114701	Perkins	 Azul (1987)	Blue (1987)	Blu (1987)	Bleu (1987)
GS90031	Solé Diesel	 Azul	Blue	Blu	Bleu
PS111044	Volvo	 Gris (1995)	Grey (1995)	Grigio (1995)	Gris (1995)
GS90034	Volvo	 Gris Aquamatic	Grey Aquamatic	Grigio Aquamatic	Gris Aquamatic
GS90005	Volvo	 Rojo (1972+)	Red (1972+)	Rosso (1972+)	Rouge (1972+)
GS90007	Volvo	 Verde agua (1972+)	Green water (1972+)	Verde acqua (1972+)	Vert (1972+)
GS90029	Volvo	 Gris (1989)	Grey (1989)	Grigio (1989)	Gris (1989)
GS90003	Volvo	 Gris metalizado SX/DPX	Grey Metal SX/DPX	Grigio metallizzato SX/DPX	Gris métallisé SX/DPX
GS90004	Yanmar	 Gris metalizado (1987+)	Grey Metal (1987+)	Grigio metallizzato (1987+)	Gris métallisé (1987+)
GS90015		Inox.	SS.	Inox.	Inox.



**GOLDENSHIP**

## KIT DE PINTURA

Kit de pintura de poliuretano bicomponente, compuesto por pintura base, endurecedor y diluyente. Puede aplicarse a pistola o brocha. Por su naturaleza de poliuretano y acrílica es muy resistente, suave y muy resistente a la intemperie salvo en casos de soporte poroso. Rendimiento por un kit: 1 capa = 10 m<sup>2</sup> 2 capas = 6 m<sup>2</sup>.

## PAINT KIT

Paint kit of two components polyurethane paint. Easy application by brush or air pistol. Its nature polyurethane and acrylic permits apply without primer except on porous surfaces. 1 layer of paint = 10 m<sup>2</sup> 2 layers of paint = 6 m<sup>2</sup>

## KIT DI VERNICE

Kit pitture in poliuretano bicomponente, composto da pittura base, indurente e diluente. Può essere applicato tramite pistola o pennello. Molto resistente alle intemperie salvo in caso di porosità. Rendimento per 1 kit: 1 strano = 10 m<sup>2</sup> 2 strati = 6 m<sup>2</sup>

## PROTECTION DU MOTEUR

Kit de peinture polyuréthane bi-composants, composé d'une base et d'un durcisseur, plus le diluant. Elle peut être appliquée au pistolet ou au pinceau. Très résistante aux intempéries sauf en cas de surface poreuse. Rendement pour 1 kit: 1 couche = 10 m<sup>2</sup> 2 couches = 6 m<sup>2</sup>

REF					
PS4688	Mercruiser	Negro	Black	Nero	Noir
PS4706	Volvo	Rojo 72	Red 72	Rosso 72	Rouge 72
PS4707	Volvo	Verde agua 72	Green water 72	Verde acqua 72	Vert acqua 72

 Supermarine



**IMPRIMACIÓN PARA MOTOR**

**SPRAY PRIMER**

**PRIMER PER MOTORI**

**PRIMER POUR MOTEUR**

REF	
GS90001	400 ml
GS90012	400 ml
GS90013	400 ml



Dotado de gran adhesión sobre acero inox, bronce, aluminio, etc.  
Aplicación a brocha o rodillo.  
Para utilizar previo al Velox.  
Utiliza el diluyente N°4

Metal primer with excellent adhesion on al metals, stainless steel, bronze, aluminum, etc.  
To be used before Velox.  
Uses thinner N°4.

Aderisce all'acciaio inox, bronzo, alluminio etc.  
Applicazione con pennello o rullo.  
Utilizzare prima Velox.  
Utilizza un diluente n°4.

Adhère à l'inox, au bronze, à l'aluminium, etc. Application au pinceau ou au rouleau.  
A appliquer avant Velox Plus.  
Utilisez avec le diluant n° 4.

REF	
SED4610100	250 cc
SED4610101	500 cc
SED4610102	2500 cc



**ANTIFOULING**

Antifouling especial para ejes, hélices y colas. Protección extra para las partes metálicas permanentemente sumergidas. No se degrada con la corriente galvánica.  
Utiliza el diluyente N°4.

Antifouling specific for submerge metal parts, as shafts, propellers and stern-drives. It's not degraded by galvanic currents.  
Uses thinner N°4.

Antivegetativa per assi, eliche e piedi. Protezione extra per le parti metalliche sommerse tutto il tempo. Non si rovina con la corrente galvanica. Utilizza un diluente N°4.

Antifouling pour arbres, hélices et embases. Protection spécifique pour les pièces métalliques immergées. Il n'est pas dégradé par les courants galvaniques. Utilisez avec le diluant N°4.

REF	
SED4612903	250 cc
SED4612902	500 cc
SED4613003	250 cc
SED4613002	500 cc
SED4613103	250 cc
SED4613102	500 cc
SED4613125	2500 cc
SED4613403	250 cc
SED4613402	500 cc



Antifouling para aplicar sobre colas fueraborda.

Antifouling for stern-drives.

Antivegetativa da applicare nei piedi fuoribordo.

Antifouling pour embases en spray.

REF	
GS90008	400 ml
GS90009	400 ml
GS90010	400 ml
GS90011	400 ml



**DILUYENTE PARA ANTIFOULING VELOX**

**THINNER FOR VELOX ANTIFOULING**

**DILUENTE PER ANTIVEGETATIVA VELOX**

**DILUANT POUR ANTIFOULING VELOX**

REF	
SED4617101	N° 2 500 cc
SED4617201	N° 4 500 cc



## MANTENIMIENTO MOTOR

## ENGINE MAINTENANCE

## MANUTENZIONE MOTORE

## MAINTENANCE MOTEUR

### PROTECTOR DE MOTOR

Producto a base de aceites y grasas que protege del óxido y la corrosión las superficies exteriores y partes eléctricas de los motores durante el invierno. Evita la formación de agarramientos debido a la presencia de salitre. Facilita el arranque eliminando los residuos de agua y humedad. Se elimina fácilmente.

### ENGINE PROTECTOR

Oil & grease made, protects from rust & corrosion external engine surface during winter storage. Removes salt deposit and loosens rusted parts. Easy to remove.

### PROTETTORE MOTORE

Prodotto a base di olio e grasso che protegge dall'ossidazione e dalla corrosione le superfici esterne e parti elettriche dei motori durante l'invernaggio. Evita la formazione dell'ossidazione dovuta alla presenza del salmaestro. Facilita l'accensione eliminando i residui di acqua e umidità. Si elimina facilmente.

### PROTECTION DU MOTEUR

Produit à base d'huiles et de graisses qui protège les surfaces extérieures et les parties électriques des moteurs de la rouille et de la corrosion pendant l'hivernage. Il empêche la formation de crises dues à la présence de salpêtre. Il facilite le démarrage en éliminant les résidus d'eau et d'humidité. Il s'enlève facilement.



REF



GS90090

500 ml

**GOLDENSHIP**

### PROTECTOR DIELECTRICO

Protector dieléctrico antihumedad para uso marino. Protege de la humedad y oxidación todos las partes eléctricas y mecánicas de los motores marinos. Ideal para invernaje de motores y mantenimiento de temporada.

### DIELECTRIC PROTECTOR

Prevents humidity and corrosion of all electric and mechanical parts in marine engines. Specially indicate for winter storages and maintenance in the season.

### PROTETTORE DIELETRICO

Protettore dielettrico antiumidità per uso marino. Protegge dalla umidità e dall'ossidazione tutte le parti elettriche e meccaniche dei motori marini. Ideale per invernaggio dei motori e manutenzione di lunga durata.

### PROTECTEUR DIELECTRIQUE

Protecteur diélectrique anti-humidité pour usage marin. Protège toutes les pièces électriques et mécaniques des moteurs marins contre l'humidité et l'oxydation. Idéal pour l'hivernage des moteurs et l'entretien saisonnier.



REF



GS90092

400 ml

**GOLDENSHIP**

### DESCALCIFICADOR DE MOTOR

Limpiador para eliminar las incrustaciones, algas, y suciedad en los motores marinos. No daña las juntas ni impulsores de goma.

### DESCALING ENGINE FLUSH

Removes scale, zebra mussels, general marine growth and vegetation rom all marine engines.

### DECALCIFICANTE MOTORE

Pulitore per eliminare le incrostazioni, alghe, e sporcizia nei motori marini. Non danneggia guarnizioni e giranti in gomma.

### DÉTARTRANT MOTEUR

Nettoyant pour éliminer le tartre, les algues et la saleté dans les moteurs marins. N'endommage pas les joints ou les turbines en caoutchouc.



REF



STA92600

3,8 L

**Star brite**

### ACEITE DE INVERNAJE

Para inyectar en los carburadores de motores a 2 y 4 tiempos. Protege las paredes de los cilindros, aros de pistones y otras superficies de la cámara de combustión durante los periodos de invernaje, facilitando el arranque del motor después de éste periodo.

### FOGGING OIL

Prevents corrosion when storing inboard or outboard engines for a extended period of time. Special formula makes starting engine after storage quick and easy.

### OLIO INVERNAGGIO

Da inserire nei carburatori dei motori da 2 e 4 tempi. Protegge le pareti dei cilindri, le fasce dei pistoni e altre superfici della camera di combustione durante il periodo di invernaggio, facilitando la partenza del motore dopo questo periodo.

### FOGGING OIL

Pour injecter dans les carburateurs des moteurs 2 et 4 temps. Il protège les parois des cylindres, segments et autres surfaces de la chambre de combustion pendant les périodes d'hivernage, facilitant le démarrage du moteur après cette période.

REF



GE22001

340 g

**RECMAR**

GE22001



**ADITIVO GASOLINA**

Elimina y previene los problemas del ethanol. Reduce todas las emisiones contaminantes. Estabiliza la química del combustible durante 1 año. Reduce el mantenimiento del sistema de combustible. Elimina la producción de carbonilla. Reduce el consumo de combustible.

**GASOLINE ADDITIVE**

Eliminates and prevents ethanol fuel problems. Reduces all emissions. Prevents fuel oxidation and stabilizes fuel chemistry for at least 1 year. Lower fuel system maintenance. Eliminates carbon build-up. Increases fuel economy.

**ADITIVO BENZINA**

Elimina e previene i problemi dell'etanolo. Riduce tutte le emissioni contaminanti. Stabilizza la chimica del combustibile durante 1 anno. Elimina la produzione di residui carboniosi. Riduce il consumo del combustibile.

**ADDITIF ESSENCE**

Élimine et prévient les problèmes d'éthanol. Réduit toutes les émissions polluantes. Stabilise la chimie du carburant pendant 1 an. Réduit l'entretien du système de carburant. Élimine la production de charbon. Réduit la consommation de carburant.

REF		PARA TRATAR HASTA TREAT UP TRATTARE FINO A POUR TRAITER JUSQU'À
STA93008	237 ml	475 L
STA93016	473 ml	950 L



**LIMPIADOR INYECTORES Y CARBURADORES GASOLINA**

Mejora la potencia y aceleración. Lubrifica todo el sistema de combustible. Maximiza el ahorro de combustible. Alarga la vida de los inyectores.

**CARBURATOR & FUEL INJECTOR CLEANER**

Improves power and acceleration. Lubricates entire fuel system. Maximizes fuel economy. Extends life of injectors and engine.

**PULITORE INIETTORE E CARBURATORE DE BENZINA**

Migliora l'accelerazione. Lubrifica tutto il sistema di combustione. Allunga la vita degli iniettori.

**NETTOYANT D'INJECTEURS ET CARBURATEURS D'ESSENCE**

Améliore la puissance et l'accélération. Lubrifie l'ensemble du système d'alimentation en carburant. Optimise les économies de carburant. Prolonge la durée de vie des injecteurs.

REF		PARA TRATAR HASTA TREAT UP TRATTARE FINO A TRAITE JUSQU'À
GE21204	250 ml	130 L
GE15210		



GE21204

GE15210

**LIMPIADOR CARBURADOR Y STARTER**

Aerosol para motores de 2 y 4 tiempos. Para limpieza del carburador y de los componentes internos del motor. Asegura arranques fáciles y ralenti suave. Despega los aros de los pistones. Restablece la potencia del motor.

**CARBURATOR & CHOKE CLEANER**

Spray for all 2 and 4 cycle engines. Marine motor de-carb. Dissolves gum, varnish dirt and carbon deposits. Restore power & performance. Reduce fuel consumption.

**PULITORE CARBURATORE**

Aerosol per motori di 2 e 4 tempi. Per la pulizia del carburatore e dei componenti interni del motore. Assicura partenze più facili e un minimo stabile. Lubrifica le fasce dei pistoni. Ristabilizza la potenza del motore.

**NETTOYANT CARBURATEUR**

Spray pour moteurs 2 et 4 temps. Pour nettoyer le carburateur et les composants internes du moteur. Assure des démarrages faciles et un ralenti en douceur. Décolle les segments du piston. Restaure la puissance du moteur.

REF	
GEGC15	354 g





### ESTABILIZADOR DE CARBURANTE

Elimina el agua, limpia los carburadores e inyectores. Contiene antioxidantes para prevenir el óxido y la corrosión. No requiere vaciar el depósito para el invierno y mantiene el combustible fresco para un rápido y fácil arranque.

### FUEL STABILIZER

Keeps fuel fresh and allows for easier starts after periods of storage. Removes water, cleans carburetors and fuel injectors. Contains antioxidant to prevent rust and corrosion.

### STABILIZZATORE CARBURANTE

Elimina l'acqua, pulisce i carburatori e iniettori. Contiene antiossidanti per prevenire l'ossidazione e la corrosione. Non è necessario svuotare il serbatoio per l'invernaggio e mantiene il carburante fresco per una rapida e facile partenza.

### STABILISATEUR DE CARBURANT

Élimine l'eau, nettoie les carburateurs et les injecteurs. Contient des antioxydants pour empêcher la rouille et la corrosion. Il ne nécessite pas de vider le réservoir pour l'hivernage et maintient le carburant frais pour un démarrage rapide et facile.

REF		PARA TRATAR HASTA TREAT UP TRATTARE FINO A POUR TRAITER JUSQU'À
GE22207	475 ml	150 L
GE22254	946 ml	1.200 L



GE22207

GE22254

### LIMPIADOR DEPOSITOS

Excepcionalmente efectivo en la limpieza de lodos y algas en depósitos de diesel. Retrasa la formación de nuevas algas que puedan contaminar el combustible. Nuevo y revolucionario aditivo que reemplaza los costosos sistemas de limpieza de los depósitos de combustible.

### FUEL TANK CLEANER

Exceptionally effective at cleaning sludge and algae from diesel tanks. Slows the recurrence of new algae that can contaminate fuel. A revolutionary new additive that replaces expensive fuel polishing and tank cleaning.

### PULITORE SERBATOIO

Eccezionale efficacia nella pulizia dal fango e alghe nel serbatoio diesel. Ritarda la formazione di nuove alghe che possono contaminare il combustibile. Nuovo e rivoluzionario additivo che rimpiazza i costosi sistemi di pulizia dei serbatoi del combustibile.

### NETTOYANT POUR RESERVOIR

Efficacité exceptionnelle pour nettoyer la boue et les algues dans le réservoir de diesel. Retarde la formation de nouvelles algues qui peuvent contaminer le carburant. Nouvel additif révolutionnaire qui remplace les systèmes coûteux de nettoyage des réservoirs de carburant.

REF		PARA TRATAR HASTA TREAT UP TRATTARE FINO A TRAITE JUSQU'À
STA93664	1,9 L	950 L
STA93116	473 ml	1.900 L



STA93664



STA93116

### ANTISALITRE

Diseñado especialmente para eliminar sedimentos de sal de cualquier superficie pintada, de metal, fibra de vidrio, vinilo, caucho, cristal o plástico. Es el método más eficaz para proteger los motores, los aparatos de pesca... Genera una capa de polímeros que evita futuras sedimentaciones.

### SALT OFF

It is specifically formulated to quickly and effectively remove salt deposits from metal, fiberglass, plastic or painted surfaces. It contains special polymers that bond to the treated surface to help prevent the formation of future deposits.

### ANTISALITRE

Appositamente progettato per rimuovere depositi di sale da qualsiasi superficie verniciata, metallo, fibra di vetro, vinile, gomma, vetro o plastica. È il metodo più efficace per proteggere motori, attrezzi da pesca... Genera uno strato di polimeri che impedisce la futura sedimentazione.

### PRODUIT ANTI-SEL "SALT OFF"

Spécialement conçu pour éliminer les dépôts de sel sur toute surface peinte, métal, fibre de verre, vinyle, caoutchouc, verre ou plastique. C'est la méthode la plus efficace pour protéger les moteurs, les engins de pêche, etc. Le revêtement PTEF® contenu dans Salt Off protège dès lors le moteur contre la rouille et la corrosion.



REF
STA94100



REF	
STA93900	3,78 L
STA93922	650 ml
STA93932	1 L

STA93922



STA93900

STA93932



### BARNACLE BUSTER® LIMPIEZA DE CIRCUITOS CONCENTRADO

RÁPIDO, SEGURO, NO TÓXICO,  
BIODEGRADABLE, NO CORROSIVO, NO  
PELIGROSO

Limpieza de circuitos refrigerados por  
agua salada.

Barnacle Buster elimina el crecimiento  
de microorganismos marinos de  
forma segura, no tóxica y es 100%  
biodegradable.

Formulado para ofrecer una  
alternativa rápida, segura y rentable  
para la limpieza de los sistemas de  
refrigeración con agua de mar sin  
dañar juntas ni metales.

Ha pasado la prueba de ensayo  
California Marine Life Toxicity Test.

Concentrado 1:4 (1 parte de Buster en  
4 partes de agua).

### BARNACLE BUSTER® MARINE GROWTH REMOVER

Barnacle Buster is a safe, non-toxic,  
and biodegradable marine growth  
remover specifically formulated to  
be a fast, safe, and cost effective  
alternative to mechanical cleaning  
of water cooled equipment. Barnacle  
Buster can safely be recirculated  
through the sea water cooling systems  
of main engines, generators, air  
conditioners, etc., dissolving barnacles,  
zebra mussels, calcium, rust, lime and  
all other mineral deposits.  
It passed the California Marine Life  
Toxicity Test.

Concentrado 1:4 (1 parte de Buster en  
4 partes de agua).

### BARNACLE BUSTER® PULIZIA DI CIRCUITI CONCENTRATI

VELOCE, SICURO, NON TOSSICO,  
BIODEGRADABILE, NON CORROSIVO,  
NON PERICOLOSO

Pulizia dei circuiti raffreddati ad  
acqua salata. Barnacle Buster elimina  
la crescita di microrganismi marini  
in modo sicuro, non tossico ed è  
biodegradabile al 100%. Formulato per  
offrire un'alternativa rapida, sicura ed  
economica per la pulizia dei sistemi  
di raffreddamento con acqua di mare  
senza danneggiare guarnizioni o  
metalli. Ha superato il test California  
Marine Life Toxicity Test.

Concentrato 1:4 (1 parte di Buster in 4  
parti d'acqua)

### BARNACLE BUSTER® LA SOLUTION ÉCOLOGIQUE

RAPIDE, SÛR, NON TOXIQUE,  
BIODEGRADABLE, NON CORROSIF,  
NON DANGEREUX

Peut être recyclé en toute sécurité à  
travers les systèmes de refroidissement  
d'eau de mer.

Élimine tous les coquillages et tous les  
autres dépôts minéraux.

Peut être utilisé en toute sécurité

dans: Moteurs, Systèmes de  
réfrigération d'eau douce ou salée,  
Condensateurs pour les systèmes de  
climatisation et de réfrigération,  
Systèmes d'eau potable, Échangeurs de  
température, Tours de refroidissement,  
Refrigidisseurs de quille, Réfrigérateurs,  
Chauffe-eau...

Il a passé le California Marine Life  
Toxicity Test.

Format concentré : 1 : 4 (1 partie de  
Buster dans 4 parties d'eau).

new

**TRAC**  
ECOLOGICAL  
Green Products

REF		
TRE1206MQ	1/4 Gal	0.95 l
TRE1206MG	1 Gal	3.785 l
TRE1206MP	5 Gal	18,9 l

REF		
TRE1212MG	1 Gal	3.785 l



### PORT-O-FLUSH JR.

Equipo de limpieza portátil para barcos  
de hasta 40', motores hasta 750hp.  
Pequeños equipos de aire  
acondicionado, generadores, sistemas  
de refrigeración, etc. Tubería hasta  
1,5" de diámetro interior, proyectos de  
lavado que van de 1 a 20 galones.

To cure: Engine Overheating, Clogged  
Pipes, Poor Heat Transfer on Air  
Conditioning & Refrigeration Systems,  
Small Parts Cleaning  
Flushing Projects Ranging From  
1-20 Gallons, Engines up to 750 HP,  
Small air conditioning & refrigeration  
systems, Piping up to 1.5" ID.

Pulizie portatili per barche fino a 40',  
motori fino a 750hp. Piccoli impianti di  
condizionamento, generatori, sistemi di  
raffreddamento, ecc. Tubi fino a 1,5" di  
diámetro interno, progetti di lavaggio  
che vanno da 1 a 20 galloni

Équipement de nettoyage portable  
pour bateaux jusqu'à 40', moteurs  
jusqu'à 750hp.  
Petit système de climatisation et de  
réfrigération, Groupe électrogène. Petit  
échangeur de température.  
Tuyauterie jusqu'à 1.5" ID. Capacité de  
rinçage de 1-20 Gallons.

**TRAC**  
ECOLOGICAL  
Green Products

REF	
TRE1245E	220V AC 12V





# Permatex

new

## FORMADORES DE JUNTAS

## GASKET MAKER

## FORMATORI GUARNIZIONE

## FORMA JOINTS

### SILKRON SPG

Silicona acética monocomponente especial para la formación de juntas. Resistente al aceite y altas temperaturas. Puede eliminarse fácilmente en desmontaje o reparación.

Single-component acetic silicone, especially for jointing. Resistant to oil and high temperatures. Can be easily removed during disassembly or repair.

Silicone acetico monocomponente, specialmente per guarnizioni. Resistente all'olio e alle alte temperature. Può essere facilmente rimosso durante lo smontaggio o la riparazione.

Silicone acétique monocomposant, notamment pour le jointoiment. Résistant à l'huile et aux températures élevées. Peut être facilement retiré lors du démontage ou de la réparation.



REF			
PER54291	-60°C--> 220°C	75 ml	24
PER54292		200 ml	12

### SILKRON HT

Sellador de silicona para la formación de juntas "in situ" con características de resistencia al aceite y altas temperaturas.

Silicone sealant for in-situ jointing with oil and high temperature resistance characteristics.

Sigillante siliconico per giunzioni in situ con caratteristiche di resistenza all'olio e alle alte temperature.

Mastic silicone pour le jointoiment in-situ avec des caractéristiques de résistance à l'huile et aux hautes températures.



REF			
PER54283	-60°C--> 300°C	300 ml	12

### SUPRA BLACK

#### MÁXIMA RESISTENCIA AL ACEITE

Formador de juntas con extraordinaria resistencia al aceite, de curado rápido, bajo olor, no corrosivo, no daña sensores de oxígeno. Posee una alta flexibilidad y resistencia al aceite como consecuencia de su sistema de adhesión patentado. Resistencia a los fluidos de automoción y vibraciones.

#### MAXIMUM OIL RESISTANCE

Sealant with outstanding oil resistance, fast curing, low odour, non-corrosive, non-damaging to oxygen sensors. High flexibility and oil resistance due to patented adhesion system. Resistant to automotive fluids and vibrations.

#### MASSIMA RESISTENZA ALL'OLIO

Sigillante con un'eccezionale resistenza all'olio, a indurimento rapido, a basso odore, non corrosivo, non dannoso per i sensori di ossigeno. Elevata flessibilità e resistenza all'olio grazie al sistema di adesione brevettato. Resistente ai fluidi e alle vibrazioni del settore automobilistico.

#### RÉSISTANCE MAXIMALE À L'HUILE

Produit d'étanchéité présentant une résistance exceptionnelle à l'huile, à durcissement rapide, à faible odeur, non corrosif, n'endommage pas les sondes à oxygène. Grande flexibilité et résistance à l'huile grâce à un système d'adhésion breveté. Résistant aux fluides automobiles et aux vibrations.



REF			
PER35124	-70°C--> 260°C	80 ml	12

### SUPRA GREY

#### MOTORES DE GRAN POTENCIA

Formulado para aplicaciones de elevado par. Muy resistente a compresión y altas presiones. No corrosivo y bajo olor. Resistente a fluidos de automoción, aceite y vibración.

#### HEAVY DUTY ENGINES

Formulated for high torque applications. Highly resistant to compression set and high pressures. Non-corrosive and low odour. Resistant to automotive fluids, oil and vibration.

#### MOTORI PER IMPIEGHI GRAVOSI

Formulato per applicazioni ad alta coppia di serraggio. Altamente resistente alla compressione e alle alte pressioni. Non corrosivo e a basso odore. Resistente ai fluidi automobilistici, all'olio e alle vibrazioni.

#### MOTEURS À USAGE INTENSIF

Formulé pour les applications à couple élevé. Hautement résistant à la compression rémanente et aux pressions élevées. Non corrosif et peu odorant. Résistant aux fluides automobiles, à l'huile et aux vibrations.



REF			
PER35134	-70°C--> 260°C	80 ml	12

### SUPRA COPPER

#### ALTA TEMPERATURA

Formador de juntas formulado para su aplicación en motores que trabajan a gran temperatura, motores de 4 cilindros, turboalimentados y de grandes prestaciones. No daña sensores de oxígeno. Tres veces más resistente al aceite que las siliconas convencionales. Color cobre.

#### HIGH TEMPERATURE

Gasket former formulated for use in high temperature, high performance, turbocharged high temperature, 4 cylinder, turbocharged and high performance engines. Will not damage oxygen sensors. Three times more oil resistant than conventional silicones. Copper coloured.

#### ALTA TEMPERATURA

Formulato per l'uso in motori ad alta temperatura, a 4 cilindri, turbocompressi e ad alte prestazioni. Non danneggia i sensori di ossigeno. Tre volte più resistente agli oli rispetto ai siliconi convenzionali. Color rame.

#### TEMPÉRATURE ÉLEVÉE

Produit d'étanchéité formulé pour être utilisé dans les moteurs à haute température, 4 cylindres, turbocompressés et à haute performance. N'endommage pas les capteurs d'oxygène. Trois fois plus résistant à l'huile que les silicones classiques. Couleur cuivre.



REF			
PER35144	-70°C--> 350°C	80 ml	12

SOLUCIONES DE INSTALACIÓN • INTALATION SOLUTIONS • SOLUZIONI INSTALLAZIONE • SOLUTIONS D'INSTALATIONS

RECAMBIOS MARINOS





**Permatex**

new

**ADHESIVOS**

**FIJADOR ALTA RESISTENCIA ROJO**  
 Formula exclusiva para motores modernos y aplicaciones de alto rendimiento que requieren resistencia a temperaturas extremas. Protege la rosca de la corrosión. Desmontable con calor y herramientas especiales.

**ADHESIVES**

**HEAVY DUTY FIXER RED**  
 Unique formula for modern engines and high performance applications requiring extreme temperature resistance. Protects threads from corrosion. Removable with heat and special tools.

**ADESIVI**

**FISSATORE PER IMPIEGHI GRAVOSI ROSSO**  
 Formula unica per motori moderni e applicazioni ad alte prestazioni che richiedono una resistenza a temperature estreme. Protegge le filettature dalla corrosione. Rimovibile con calore e strumenti speciali.

**ADHÉSIFS**

**FIXATEUR POUR TRAVAUX LOURDS ROUGE**  
 Formule unique pour les moteurs modernes et les applications haute performance nécessitant une résistance à des températures extrêmes. Protège les filets de la corrosion. Démontable à la chaleur et avec des outils spéciaux.

REF			
PER35375	-54°C--> 149°C	50 ml	6

**FIJADOR MEDIA RESISTENCIA AZUL**  
 Evita el aflojado causado por las vibraciones. Protege la rosca de la corrosión. Desmontable con herramientas de mano.

**MEDIUM-STRENGTH FIXATIVE BLUE**  
 Prevents loosening caused by vibrations. Protects the thread from corrosion. Can be removed with hand tools.

**BLU FISSATIVO A MEDIA RESISTENZA**  
 Impedisce l'allentamento causato dalle vibrazioni. Protegge la filettatura dalla corrosione. Può essere rimosso con attrezzi manuali.

**BLEU FIXATEUR DE FORCE MOYENNE**  
 Empêche le desserrage causé par les vibrations. Protège le fil de la corrosion. Peut être retiré avec des outils manuels.

REF			
PER35395	-54°C--> 149°C	50 ml	6



**GRASA DE SPRAY**

Lubricante especial de larga duración. Su fluidez facilita la aplicación y su secado rápido permite una óptima lubricación incluso en lugares inaccesibles. No descuelga. Resistencia a altas presiones.

**GREASE SPRAY**

Special long lasting lubricant. Its fluidity facilitates the application and its quick drying allows an optimal lubrication even in inaccessible places. No sagging. High pressure resistance.

**GRASSO A SPRUZZO**

Lubrificante speciale a lunga durata. La sua fluidità lo rende facile da applicare e le sue proprietà di asciugatura rapida consentono una lubrificazione ottimale anche in punti inaccessibili. Nessun cedimento. Resistenza alle alte pressioni.

**GRAISSE EN SPRAY**

Lubrifiant spécial longue durée. Sa fluidité facilite l'application et son séchage rapide permet une lubrification optimale même dans les endroits inaccessibles. Pas d'affaissement. Résistance à la haute pression.

REF		
PER35621	500 ml	12



**AFLOJATODO**

Penetrante y lubricante grafitado para soltar, deslizar o desenroscar con facilidad toda clase de piezas agarrotadas por el óxido o la suciedad. Facilita el posterior desmontaje.

**FAST BREAK**

Penetrant and graphitized lubricant for easy loosening, sliding or unscrewing of all kinds of parts seized by rust or dirt. Facilitates subsequent disassembly.

**ALLENATA TUTTO**

Penetrante e lubrificante grafitizzato per facilitare l'allentamento, lo scorrimento o lo svitamento di tutti i tipi di parti bloccate dalla ruggine o dallo sporco. Facilita lo smontaggio successivo.

**LIBÈRE TOUT**

Lubrifiant pénétrant et graphité pour faciliter le desserrage, le glissement ou le dévissage de toutes sortes de pièces grippées par la rouille ou la saleté. Facilite le démontage ultérieur.

REF		
PER35611	400 ml	24



**LIMPIA MOTORES TERCLEN**

Para limpiar toda clase de motores, piezas mecánicas, suelos de garajes, etc. No ataca la pintura, gomas o plásticos de motor.

**TERCLEN ENGINE CLEANER**

For cleaning all kinds of engines, mechanical parts, garage floors, etc. Does not attack paint, rubber or engine plastics.

**PULIZIA DI MOTORI TERCLEN**

Per la pulizia di tutti i tipi di motori, parti meccaniche, pavimenti di garage, ecc. Non attacca la vernice, la gomma o le plastiche del motore.

**NETTOYANT MOTEUR TERCLEN**

Pour le nettoyage de toutes sortes de moteurs, de pièces mécaniques, de sols de garage, etc. N'attaque pas la peinture, le caoutchouc ou les plastiques du moteur.

REF		
PER17762	400 ml	24







# Permatex

new

## SELLADOR DE JUNTAS

Producto sellante de secado al aire con gran poder de adhesión. Permanece flexible sin agrietarse en vibraciones y cambios de temperatura. Resistente a la gasolina, el aceite y refrigerantes.

## GASKET CEMENT

Air-drying sealant with high adhesion power. Remains flexible without cracking under vibration and temperature changes. Resistant to petrol, oil and coolants.

## SIGILLATORE GUARNIZIONE

Sigillante che asciuga all'aria con un elevato potere di adesione. Rimane flessibile senza incrinarsi in presenza di vibrazioni e sbalzi di temperatura. Resistente a benzina, olio e refrigeranti.

## JOINT SEALANT

Scellant séchant à l'air avec un pouvoir d'adhésion élevé. Reste flexible sans se fissurer sous l'effet des vibrations et des changements de température. Résistant à l'essence, à l'huile et aux liquides de refroidissement.



REF			
PER35572	-54°C--> 204°C	118 ml	8

## SELLADOR DE JUNTAS DE ALTA TEMPERATURA

Sellador de cobre de secado rápido que ayuda a disipar el calor, previene el calentamiento de las juntas y mejora la transferencia de calor. Rellena irregularidades de la superficie. Sella instantáneamente. Resiste todo tipo de fluidos de automoción. Aplicaciones: juntas de culata, juntas de colector de escape, turbocompresores.

## HIGH TEMPERATURE GASKET SEALANT

Fast drying copper sealant that helps dissipate heat, prevents joints from heating up and improves heat transfer. Fills surface irregularities. Seals instantly. Resists all types of automotive fluids. Applications: cylinder head gaskets, exhaust manifold gaskets, turbochargers.

## SIGILLANTE PER GIUNTI AD ALTA TEMPERATURA

Sigillante per rame a rapida essiccazione che aiuta a dissipare il calore, impedisce il riscaldamento dei giunti e migliora il trasferimento del calore. Riempie le irregolarità della superficie. Sigilla istantaneamente. Resiste a tutti i tipi di fluidi automobilistici. Applicazioni: guarnizioni della testa del cilindro, guarnizioni del collettore di scarico, turbocompressori.

## JOINT D'ÉTANCHÉITÉ HAUTE TEMPERATURE

Produit d'étanchéité en cuivre à séchage rapide qui aide à dissiper la chaleur, empêche les joints de chauffer et améliore le transfert de chaleur. Comble les irrégularités de surface. Scelle instantanément. Résiste à tous les types de fluides automobiles. Applications : joints de culasse, joints de collecteur d'échappement, turbocompresseurs.



REF		
PER35580	331 ml	12

## ESMERIL PARA VALVULAS AL AGUA

Producto destinado para el esmerilado (pulido) de válvulas al agua. Contiene inhibidores para evitar la oxidación de las válvulas y asientos.

## GRINDING FOR WATER-OPERATED VALVES

Product intended for grinding (polishing) of water valves. Contains inhibitors to prevent rusting of valves and seats. Coarse grit

## SMERIGLIATRICE PER VALVOLE DELL'ACQUA

Prodotto destinato alla rettifica (lucidatura) delle valvole dell'acqua. Contiene inibitori per prevenire la ruggine di valvole e sedi.

## PATE A RODER POUR SOUPAPES

Produit destiné au meulage (polissage) des sièges de soupape. Contient des inhibiteurs pour empêcher la rouille des soupapes et des sièges.



REF						
PER12073	100 ml	24	Grano grueso	Coarse grain	Grana grossa	Grain grossier
PER12063	100 ml	24	Grano fino	Fine grain	Grano fino	Grain fin



SOLUCIONES DE INSTALACIÓN • INTALATION SOLUTIONS • INTALAZIONE • SOLUZIONI INSTALLAZIONE • SOLUTIONS D'INSTALLATIONS



**LUBRICANTE PARA 2 TIEMPOS**

**ACEITE 2 TIEMPOS TC-W3**

Especialmente formulado para motores marinos de 2 tiempos. Inhibidor de corrosión y herrumbre. Gran capacidad de limpieza de las partes internas del motor (pistón, bujías...), evita el pegado de segmentos y la formación de depósitos. Alta fluidez a bajas temperaturas.

**2-STROKE LUBRICANT**

**2-STROKE TC-W3 OIL**

Specially formulated for 2-stroke marine engines. Excellent anti-wear protection for the internal parts of the engine. When the engine is not in use, it effectively protects from corrosion and rust. Very effective in maintaining the internal parts of the engine (pistons, spark plugs, etc.) clean, avoiding piston rings from sticking and sediments accumulating.

**LUBRICANTE PER 2 TEMPI**

**OLIO 2 TEMPI TC-W3**



Formulazione specificamente studiata per motori marino a 2 tempi. Eccellente protezione contro l'usura dei componenti interni del motore. Garantisce un'alta protezione contro la corrosione e la ruggine. Contribuisce a mantenere pulite le parti interne del motore (pistone, candela, ecc.), evita l'aderenza delle fasce del pistone e la formazione di depositi. Alta fluidità a basse temperature.

**HUILE POUR MOTEURS 2 TEMPS**

**HUILE 2 TEMPS TC-W3**

Formulation spécialement conçue pour les moteurs marins 2 temps. Excellente protection contre l'usure des composants internes du moteur. Il garantit une haute protection contre la corrosion et la rouille. Il aide à maintenir les parties internes du moteur propres (piston, bougie, etc.), évite l'adhérence des segments et la formation de dépôts. Grande fluidité à basses températures.

QUALITY LEVELS  
NMMA TC-W3  
(NMMA, National Marine  
Manufacturers Association)

REF		
REC2TU6	1 L	6
REC2TU3	5 L	3



**ACEITE MEZCLA 2 TIEMPOS**

**2 CYCLE OIL**

**OLIO MISCELA 2 TEMPI**

**HUILE 2 TEMPS**

**PREMIUM PLUS**

REF	OEM		
RM92-858026QB1U6	92-858026QB1	1 L	6
RM92-858027QB1U3	92-858027QB1	3,8 L	3



**OPTIMAX / DFI**

REF	OEM		
RM92-858037QB1U3	92-858037QB1	3,8 L	3



**TABLA APLICACIÓN ACEITES 2 TIEMPOS**

**2-STROKE OIL APPLICATION TABLE**

**TABELLA APPLICAZIONE OLIO 2 TEMPI**

**TABLEAU D'APPLICATION D'HUILE 2 TEMPS**

MOTOR	REF
2.5 hp --> 30 hp	REC2TU3
40 hp --> 115 hp	REC2TU3
115 hp+	RM92-858037QB1U3
inyección directa direct injection iniezione diretta injection directe	RM92-858037QB1U3

## LUBRICANTE PARA 4 TIEMPOS

## 4-STROKE LUBRICANT

## LUBRICANTE PER 4 TEMPI

## HUILE POUR MOTEURS 4 TEMPS

SAE 5W40

### ACEITE 100% SINTÉTICO

Excelente fluidez en frío, facilita el arranque y reduce los desgastes de motor. Evita el pegado de segmentos al dispersar lodos, barnices y otros productos de oxidación a altas temperaturas. Contiene inhibidores antiherrumbre y anticorrosión.

### 100% SYNTHETIC OIL

Good fluidity in cold temperatures facilitates performance and reduces engine wear. It avoids piston rings from sticking by clearing dirt, varnish and other oil oxidation deposits when subject to high temperatures. Contains effective anti-rust and anti-corrosion inhibitors that protect the engine in the marine environment.

### OLIO 100% SINTETICO

Buona fluidità a freddo, facilita la messa in moto e riduce l'usura del motore. Evita l'aderenza delle fasce del pistone, disperdendo fanghi, lacche e altri prodotti derivanti dall'ossidazione dell'olio ad alte temperature. Contiene efficaci inibitori antiruggine e anticorrosione, per proteggere il motore in ambiente marino.

### HUILE 100% SYNTHÉTIQUE

Bonne fluidité à froid qui aide au démarrage et réduit la détérioration du moteur. Evite le collage des segments lors de la dispersion de boue dans le moteur, vernis et autres produits oxydant l'huile à haute température. Contient des inhibiteurs de corrosion et antirouille.

QUALITY LEVELS  
API SN/CF  
ACEA A3/B3/B4  
MB 229.3  
VW 502.00/505.00  
RN 710  
OPEL A&B  
JASO MA2



REF		
REC5W40U6	1 L	6
REC5W40U3	5 L	3
REC5W40205L	205L	1



Especialmente desarrollado para motores de alto rendimiento. Las propiedades especiales de este aceite le permiten lubricar el motor incluso durante el arranque a baja temperatura. El aceite combate la acumulación de lodo y brinda una excelente protección contra el desgaste. Especialmente adecuado para motores que están sujetos a arranques y paradas frecuentes.

Specially developed for high performance engines. The special properties of this oil allow it to lubricate the engine even during low temperature starting. The oil combats sludge build-up and gives excellent protection against wear. Particularly suitable for engines that are subject to frequent starting and stopping.

Sviluppato appositamente per motori ad alte prestazioni. Le proprietà speciali di questo olio consentono di lubrificare il motore anche durante l'avviamento a bassa temperatura. L'olio combatte il fango accumulato e offre un'eccellente protezione contro l'usura. Particolarmente adatto per motori soggetti a frequenti avviamenti e arresti.

Spécialement développé pour les moteurs hautes performances. Les propriétés particulières de cette huile vous permettent de lubrifier le moteur même lors d'un démarrage à basse température. L'huile combat l'accumulation de boue et offre une excellente protection contre l'usure. Particulièrement adapté aux moteurs soumis à des démarrages et arrêts fréquents.

REF	OEM		
REC21363429	21363429	1 L	API SM
REC21363430	21363430	5 L	

**VOLVO PENTA**



SAE 10W30  
SAE 10W40

REF	OEM		
RM92-8M0086220U6	92-8M0086220	1 L	6
RM92-8M0086221U3	92-8M0086221	4 L	3

**QUICKSILVER**



RM92-8M0086220U6

RM92-8M0086221U3





**SAE 10W30  
SAE 10W40**

**ACEITE SINTÉTICO PREMIUM**

Lubricante marino reforzado con bases sintéticas, para motores gasolina 4T fueraborda e intraborda. Especificaciones NMMA FC-W. HTHS elevado, asegura viscosidad a elevadas temperaturas. Anticorrosivo con antioxidantes incorporados, elevadas propiedades antiespumantes.

QUALITY LEVELS:  
NMMA FC-31015T  
(NMMA, National Marine  
Manufacturers Association)  
API SJ/SG



REF		
REC10W30U6	1 L	6
REC10W30U3	5 L	3
REC10W3020L	20 L	1
REC10W3050L	50 L	1
REC10W30205L	205 L	1



**SYNTHETIC PREMIUM OIL**

Marine lubricant strengthened with a synthetic base, especially formulated for outboard and inboard 4T petrol engines, with NMMA FC-W specifications. With a high HTHS, it ensures great viscosity at high temperatures. Better anti-oxidant resistance. Improved anti-foaming properties.

QUALITY LEVELS  
NMMA FC-11815R  
(NMMA, National Marine  
Manufacturers Association)  
API SJ/SG

REF		
REC10W40U6	1 L	6
REC10W40U3	5 L	3
REC10W4020L	20 L	1
REC10W4050L	50 L	1
REC10W40205L	205 L	1

**OLIO SINTETICO PREMIUM**

Lubrificante marino potenziato con basi sintetiche, specificamente formulato per motori a benzina 4T fuoribordo ed entrobordo, a norma specifiche NMMA FC-W. Con indice HTHS più elevato, garantisce un'alta viscosità a temperature elevate. Aumenta la protezione anticorrosione. Maggior resistenza all'ossidazione. Proprietà antischiuma migliorate.

**HUILE SYNTHÉTIQUE PREMIUM**

Lubrifiant marin renforcée avec des bases synthétiques, pour les moteurs à essence 4T hors-bord et inboard avec des spécifications NMMA FC-W. Avec des HTHS supérieures, qui vous assure une haute viscosité à des températures élevés. Résistance antioxydante majeure. Propriétés anti-mousse améliorées.





**SAE 15W40  
MULTIGRADE HIGH PERFORMANCE**

Lubricante multigrado marino, superior al nivel SHPD, especialmente formulado para motores marinos turboalimentados. Contiene inhibidores de corrosión, oxidación, herrumbre y antiespumantes. Capacidad detergente, reduce los depósitos en válvulas y pistones. Excelentes cualidades dispersantes antilodos.

QUALITY LEVELS  
API CI-4/SL  
ACEA E7  
Caterpillar ECF-1<sup>a</sup>  
Cummins CES 20071/72/76/77/78  
MACK EO-M+  
MAN M3275  
MB 228.3  
MTU Level 2  
Renault RLD/RLD-2  
Volvo VDS-2 VDS-3

Marine multigrade oil, exceeds the SHPD performance level, especially formulated to meet the demanding requirements of 4-stroke diesel turbocharged engine manufacturers in the marine environment. Contains effective corrosion, oxidation, rust and foam inhibitors. Excellent detergent effect that reduces sediments in valves and pistons. Very good dispersion qualities that prevent sludge in cold temperatures.

REF		
REC15W40U3	5 L	3
REC15W4020L	20 L	1
REC15W4050L	50 L	1
REC15W40205L	205 L	1

Olio marino multigrado, con prestazioni oltre il livello SHPD, specificamente formulato per soddisfare le particolari esigenze dei motori diesel a 4 tempi turboalimentati in ambiente marino. Contiene efficaci inibitori contro corrosione, ossidazione, ruggini e formazione di schiuma. Eccellente capacità detergente, riduce i depositi in valvole e pistoni. Ottime qualità disperdenti che impediscono la formazione di fanghi a freddo.

Huile multigrade marine, dépasse les niveaux de performances SHPD, spécialement conçu pour les moteurs diesel 4T avec turbo. Contient des inhibiteurs contre la corrosion, l'oxydation, antirouille et anti-mousse. Évite les dommages dans les chemises, habituel sur les moteurs suralimentés de haute puissance. Haute qualité dispersante pour empêcher l'apparition de boue dans le moteur.





**ACEITE MOTORES DIESEL**

**DIESEL ENGINES OIL**

**OLIO MOTORE DIESEL**

**HUILE MOTEUR DIESEL**

REF	OEM		
RM92-8M0096794U3	92-8M0096794	3,8 L	3



**ACEITE MINERALES VDS-3**

**VDS-3 MINERAL GEAR OILS**

**OLIO MINERALE VDS-3**

**HUILE MINÉRALE VDS-3**

VDS-3 cubre los requisitos más estrictos sobre la limpieza del pistón en comparación con VDS-2, lo que garantiza la durabilidad y fiabilidad de los motores. La alta calidad del aceite VDS-3 permite un aumento en los intervalos de drenaje. Para motores diesel y de gasolina (ver manuales de los operadores).

VDS-3 covers even more stringent requirements on piston cleanliness and bore polish compared to VDS-2, ensuring the durability and reliability of the engines. The high quality of VDS-3 oil allows in certain cases an increase in drain intervals. Fits both diesel and gas engines (check operators manuals).

VDS-3 copre requisiti ancora più stringenti sulla pulizia del pistone e sulla lucidatura del foro rispetto a VDS-2, garantendo la durata e l'affidabilità dei motori. L'alta qualità dell'olio VDS-3 consente un aumento degli intervalli di scarico. Adatto sia ai motori diesel che a quelli a gas (consultare i manuali degli operatori).

Le VDS-3 couvre les exigences les plus strictes en matière de nettoyage des pistons par rapport au VDS-2, ce qui garantit la durabilité et la fiabilité des moteurs. La haute qualité de l'huile VDS-3 permet une augmentation des intervalles de vidange. Pour les moteurs diesel et essence (voir les manuels d'utilisation).

REF	OEM		
REC22479638	22479638	1 L	API CI-4
REC22479642	22479642	5 L	ACEA E5



**SAE 25W40**

**ACEITE SINTÉTICO 4T**

**4 STROKES SYNTHETIC OIL**

**OLIO SINTETICO 4 TEMPI**

**HUILE SYNTHÉTIQUE 4T**



Lubricante sintético para motores con cargas y RPM elevadas. Excelentes inhibidores de corrosión, oxidación y desgaste. Buenas propiedades de arranque en frío, antiespumantes incorporados.

Synthetic oil for 4-stroke engines suitable for engines with high RPM and heavy loads. Lubrication of all engine components, great anti-corrosion, anti-oxidation and anti-wear properties. Good performance in cold conditions. Keeps the engine clean and increases protection against corrosion in saline water environments.

Olio sintetico per motori a 4 tempi, adatto a motori con elevati RPM e carichi pesanti. Lubrificazione di tutti i componenti del motore, elevate proprietà anticorrosione, antiossidazione e antiusura. Buone proprietà di avvio a freddo.

Huile synthétique pour des moteurs 4T adapté aux moteurs avec des hauts RPM. Grande capacité anti-corrosion, anti-oxydation et contre l'usure. Propriétés adéquates pour un démarrage à froid. Elle maintient la propreté du moteur et augmente la protection face à la corrosion du à l'environnement salin.

QUALITY LEVELS  
NMMA FC13101T  
(NMMA, National Marine  
Manufacturers Association)  
API SJ/SG

REF		
REC25W40U6	1 L	6
REC25W40U3	5 L	3
REC25W40205L	205 L	1



**ACEITE SINTÉTICO PARA MOTORES VERADO**

**SYNTHETIC OIL FOR VERADO ENGINES**

**OLIO SINTETICO PER MOTORI VERADO**

**HUILE SYNTHÉTIQUE POUR VERADO**

REF	OEM		
RM92-8M0086227U3	92-8M0086227	4 L	3
RM92-8M0086226U6	92-8M0086227	1 L	6





**ACEITE MOTORES GASOLINA**

**GASOLINE ENGINES OIL**

**OLIO MOTORE BENZINA**

**HUILE MOTEUR ESSENCE**

REF	OEM		
RM92-8M0086224U3	92-8M0086224	3,8 L	3
RM92-8M0086223U6	92-8M0086224	1 L	6



SAE 25W50

ACEITE SINTÉTICO 4T  
HIGH PERFORMANCE

Recomendado para motores fueraborda Verado y otros motores high performance.

4 STROKES  
SYNTHETIC OIL  
HIGH PERFORMANCE

Recommended for use in Verado outboards and others high-performance marine engines.

OLIO SINTETICO 4 TEMPI  
HIGH PERFORMANCE

Consigliato per fuoribordo Verado e altri motori ad alte prestazioni.

HUILE SYNTHÉTIQUE 4T  
HIGH PERFORMANCE

Recommandé pour les hors-bord Verado et autres moteurs hautes performances.



REF	OEM		
RM92-8M0096256U6	92-8M0096256	1 L	6
RM92-858084QE1U3	92-8M0096256	4 L	3



SAE 75W90

ACEITE PARA TRANSMISIÓN IPS

Lubricante marino sintético GL-5 para transmisiones IPS y reductoras. Soporta elevadas temperaturas internas sin descomponerse así como cargas considerables sin causar desgaste. Excelente protección a cualquier temperatura.

OIL FOR IPS TRANSMISSION

GL-5 synthetic oil of the highest quality for marine drives and IPS transmissions. It can also withstand very high temperatures without breaking down. Withstands heavy loads preventing wear.

OLIO PER TRASMISSIONE IPS

Olio sintetico GL-5 di altissima qualità per s-drive, transmisioni IPS e riduttori. In quanto olio sintetico, garantisce un'eccellente protezione a basse ed elevate temperature. Può inoltre sostenere altissime temperature senza decomposi. Sostiene carichi considerevoli senza provocare usura.

HUILE SYNTHETIQUE POUR TRANSMISSIONS

Huile synthétique GL-5 de haute qualité pour transmissions IPS, SX etc... En tant qu'huile synthétique, elle garantit une excellente protection à basses et hautes températures. Elle peut également résister à des températures très élevées sans se détériorer. Elle supporte des charges considérables sans provoquer d'usure.

QUALITY LEVELS  
API GL-5

REF		
REC75W90U6	1 L	6
REC75W90U3	5 L	3
REC75W9020L	20 L	1
REC75W90205L	205L	1



Aceite de transmisión marina de alto rendimiento diseñado para proporcionar la máxima protección para las colas Volvo Penta IPS y Aquamatic. Específicamente formulado para ofrecer un excelente rendimiento bajo cargas y temperaturas extremas a la vez que proporciona propiedades de fricción equilibradas entre agarre y deslizamiento y máxima protección contra el desgaste y la corrosión. La tecnología avanzada de los aditivos incluye una capacidad única para minimizar el daño debido a la contaminación del agua.

High performance marine transmission oil designed to provide maximum protection for Volvo Penta IPS and Aquamatic sterndrives. Specifically formulated to offer excellent performance under extreme loads and temperatures while providing balanced frictional properties between grip and slip and maximum protection against wear and corrosion. Advanced additive technology include unique capability to minimize damage due to water contamination.

Olio per trasmissioni marine ad alte prestazioni progettato per fornire la massima protezione per Volvo Penta IPS e entrofuoribordo Aquamatic. Specificamente formulato per offrire prestazioni eccellenti in presenza di carichi e temperature estreme, fornendo al tempo stesso proprietà di attrito bilanciate tra aderenza e scivolamento e massima protezione contro l'usura e la corrosione. La tecnologia additiva avanzata include la capacità unica di minimizzare i danni dovuti alla contaminazione dell'acqua.

Huile de transmission marine haute performance conçue pour fournir une protection maximale pour les IPS et les embases Aquamatic, en présence de charges et de températures extrêmes, tout en offrant des propriétés de friction équilibrées entre l'adhérence et le glissement et une protection maximale contre l'usure et la corrosion. La technologie additive avancée comprend la capacité unique de minimiser les dommages dus à la contamination de l'eau.

REF	OEM	
REC22479650	22479650	1 L
REC22479648	22479648	5 L





## SAE 75W140

### ACEITE PARA TRANSMISION

Lubricante marino de alto rendimiento para transmisiones. Excelentes prestaciones que evitan el desgaste y presiones extremas, la temperatura ambiente y condiciones de trabajo no alteran su capacidad lubricante.

#### QUALITY LEVELS

API GL-5  
API MT-1  
ARVIN MERITOR 0-76-M  
Mack GO-J  
MIL-PRF-2105E  
SAE J2360  
Scania STO 1:0 - 2:0A  
ZF TE-ML 05A - 07A - 12N - 16F - 19C - 21A

REF		
REC75W140U3	5 L	3

### OIL FOR TRANSMISSION

High performance oil designed for marine transmissions. Excellent performance that prevents wear and extreme pressure, providing maximum protection to the transmission; temperatures and working conditions do not alter its lubricating effect.



### OLIO PER TRASMISSIONE

Olio ad alto rendimento per trasmissioni nautiche. Eccellenti prestazioni che evitano usura e pressioni estreme, garantendo la massima protezione della trasmissione; la temperatura ambiente e le condizioni di lavoro non ne modificano le proprietà lubrificanti. Temperatura e rumore ridotti grazie alla riduzione dell'attrito.

### HUILE SYNTHETIQUE POUR TRANSMISSIONS

Huile haute performance pour embase DP-G, DPH 1.59/1 qui évite l'usure et les pressions extrêmes, assurant une protection maximale de la transmission; la température ambiante et les conditions de travail ne modifient pas leurs propriétés lubrificantes. Température et bruit réduits grâce à la réduction des frottements.



### ACEITE PARA TRANSMISION IPS/ AQUAMATIC

Aceite de transmisión marina de alto rendimiento diseñado para proporcionar la máxima protección para las colas Volvo Penta IPS y Aquamatic. Específicamente formulado para ofrecer un excelente rendimiento bajo cargas y temperaturas extremas a la vez que proporciona propiedades de fricción equilibradas entre agarre y deslizamiento y máxima protección contra el desgaste y la corrosión. La tecnología avanzada de los aditivos incluye una capacidad única para minimizar el daño debido a la contaminación del agua.

DHP (ratio 1.59:1 (D6-400)  
DPG (KAD300)

REF	OEM	
REC22574246	22574246	5 L

**VOLVO PENTA**

### OIL FOR IPS / AQUAMATIC TRANSMISSION

High performance marine transmission oil designed to provide maximum protection for Volvo Penta IPS and Aquamatic sterndrives. Specifically formulated to offer excellent performance under extreme loads and temperatures while providing balanced frictional properties between grip and slip and maximum protection against wear and corrosion. Advanced additive technology include unique capability to minimize damage due to water contamination.



### OLIO PER TRASMISSIONE IPS/ AQUAMATIC

Olio per trasmissioni marine ad alte prestazioni progettato per fornire la massima protezione per Volvo Penta IPS e entrofuoribordo Aquamatic. Specificamente formulato per offrire prestazioni eccellenti in presenza di carichi e temperature estreme, fornendo al tempo stesso proprietà di attrito bilanciate tra aderenza e scivolamento e massima protezione contro l'usura e la corrosione. La tecnologia additiva avanzata include la capacità unica di minimizzare i danni dovuti alla contaminazione dell'acqua.

### HUILE POUR TRANSMISSION IPS/AQUAMATIC



Huile de transmission marine haute performance conçue pour fournir une protection maximale pour les embases DP-G, DPH 1.59/1. Formulé spécifiquement pour offrir d'excellentes performances en présence de charges et de températures extrêmes, tout en offrant des propriétés de friction équilibrées entre l'adhérence et le glissement et une protection maximale contre l'usure et la corrosion. La technologie additive avancée comprend la capacité unique de minimiser les dommages dus à la contamination de l'eau.

## SAE 80W90

### ACEITE SINTÉTICO PARA TRANSMISION

Lubricante marino para transmisiones de motores intraborda y fueraborda de los principales fabricantes, que requieren aceites con una calidad API GL 5. Consulte el manual de usuario antes de elegir el lubricante.

#### QUALITY LEVELS

REF		
REC80W90U6	1 L	6
REC80W90U3	5 L	3
REC80W9017L	17L	1



### SYNTHETIC OIL FOR TRANSMISSION

GL-5 synthetic oil of the highest quality for marine drives and IPS Oil recommended for the transmission of inboard and outboard engines of the main manufacturers that require API GL 5 quality oils. Read the user manual before choosing a lubricant.



### OLIO SINTETICO PER TRASMISSIONE

Olio sintetico GL-5 di altissima qualità per s-drive, trasmissioni IPS e riduttori. Olio consigliato per trasmissioni entrofuoribordo e fuoribordo dai principali produttori che richiedono oli di qualità API GL 5. Consultare il manuale d'uso prima di scegliere il lubrificante.

### HUILE SYNTHETIQUE POUR TRANSMISSIONS

Huile synthétique GL-5 de la plus haute qualité pour les transmissions marines et IPS Oil recommandée pour la transmission des moteurs in-bord et hors-bord des principaux fabricants qui nécessitent des huiles de qualité API GL 5. Lisez le manuel d'utilisation avant de choisir un lubrifiant.

Las propiedades de lubricación protegen el accionamiento y la transmisión incluso bajo cargas pesadas. También proporciona una excelente protección contra la corrosión. Soporta altas temperaturas sin romperse.

Lubrication properties protect drive and transmission even under heavy load. Also provides excellent corrosion protection. Withstands high temperatures without breaking down.

Le proprietà di lubrificazione proteggono l'azione e la trasmissione anche sotto carico pesante. Offre inoltre un'eccellente protezione dalla corrosione. Resiste alle alte temperature senza rompersi.

Protège l'embase et la transmission grâce à ses propriétés lubrifiantes même en cas de charge élevées. Offre une excellente protection contre la corrosion. Supporte les températures élevées sans se décomposer.

REF	OEM		GRADO GRADE GRADE
REC85122800	85122800	1 L	API GL-5
REC3809445	3809445	5 L	

**VOLVO PENTA**



**ACEITE MINERALES**

**MINERAL GEAR OILS**

**OLIO MINERALE**

**HUILE MINÉRALE**

Para colas de transmisión mecánica. Especialmente indicados para los motores de gran cilindrada o de uso frecuente. Fabricado con aditivos especiales para proveer una máxima durabilidad e inhibidores de la corrosión para una mayor protección contra el óxido y la corrosión.

Lower Unit Gear Lube for mechanical drives. Lower Unit Gear Lube. Ideal for modern outboard and stern drive lower units. Will not avoid manufacturers' warranties.

Per piedi poppieri a trasmissione meccanica. Indicato specialmente per motori di grande cilindrata o di uso frequente. Fabricato con additivi speciali per fornire una massima durata e impedire la corrosione per una maggiore protezione contro l'ossidazione e la corrosione.

Pour les embases mécanique. Particulièrement adapté pour les moteurs de grande cylindrée ou à usage fréquent. Fabriqué avec des additifs spéciaux pour offrir une durabilité maximale et des inhibiteurs de corrosion pour une meilleure protection contre la rouille et la corrosion.

REF		
LUB11552U12	1 L	12

**LubriMatic**



**SAE 90**

**ACEITE HIGH PERFORMANCE**

**HIGH-PERF GEAR LUBE**

**OLIO HIGH PERFORMANCE**

**HUILE HIGH PERFORMANCE**

Aceite sintético de altas prestaciones. Para colas de transmisión mecánica.

High performance synthetic Lower Unit Gear Lube for mechanical drives.

Olio sintetico di alta prestazione. Per piedi poppieri a trasmissione meccanica.

Huile synthétique haute performance. Pour transmissions mécanique.

REF	OEM		
RM92-858064QB1U6	92-858064QB1	1 L	6
RM92-858065QB1U2	92-858065QB1	9,5 L	2



**QUICKSILVER**

RM92-858064QB1U6



RM92-858065QB1U2



REF	OEM		
RM92-8M0121960U12	90-8M0121960	137 ml	12

**QUICKSILVER**



**new**

## ISO46

### ACEITE HIDRÁULICO ISO46

Fluidos microfiltrados de alta calidad para presiones extremas. Indicado para sistemas hidráulicos como pasarelas, tenderlift, grúas, etc.

### HYDRAULIC OIL ISO46

High quality micro-filtered fluids for extreme pressure. Suitable for hydraulic systems such as gangways, tenderlifts, cranes, etc.

### OLIO IDRAULICO ISO46

Fluidi microfiltrati di alta qualità per pressioni estreme. Adatto per sistemi idraulici come passerelle, tender lift, gru, ecc.

### HUILE HYDRAULIQUE ISO46

Fluides microfiltrés de haute qualité pour une pression extrême. Convient aux systèmes hydrauliques tels que les passerelles, les monte-charges, les grues, etc.

REF		
RECISO46U3	5 L	3
RECISO46U6	1 L	6



**new**

## ATF

### TRANSMISIÓN AUTOMÁTICA

Fluido hidráulico marino sintético tipo ATF. Especialmente indicado para transmisiones automáticas, servomecanismos y direcciones asistida. Formula sintética de elevada viscosidad, incorpora anticorrosivos y antiespumantes.

### AUTOMATIC TRANSMISSION

ATF synthetic hydraulic fluid. Especially suited for automatic transmissions, servo-devices, power-assisted steering. Provides a smooth performance without transmission knocks. Provides high protection against corrosion and excellent fluidity at low temperatures. Prevents foaming and provides rubber seal stability.

### TRASMISSIONE AUTOMATICA

Fluido idraulico sintetico di tipo ATF. Specificamente indicato per trasmissioni automatiche, servomeccanismi, servotimoni. Alta capacità antiusura, per prolungare la vita utile dei meccanismi. Garantisce un funzionamento fluido e senza scatti della trasmissione. Alta protezione contro la corrosione ed eccellente fluidità a basse temperature. Bassa formazione di schiuma e stabilità in presenza di guarnizioni di gomma.

### HUILE HYDRAULIQUE DEXRON III

Fluide hydraulique synthétique de type ATF. Spécifiquement indiqué pour les transmissions automatiques, servomécanismes et aux directions hydrauliques. Haute capacité anti-usure, pour prolonger la durée de vie des mécanismes. Elle assure un fonctionnement fluide de la transmission. Haute protection contre la corrosion et excellente fluidité à basses températures. Faible moussage. N'abime pas les joints en caoutchouc.

QUALITY LEVELS  
GM DEXRON IIIIG / IID-IIIE  
FORD MERCON  
ALLISON C-4 TES-228, TES 389  
MB 236.9 - MB 236.5  
ZF TE-ML 02F/03D/04D/05L/09/11A/17C/21L  
Caterpillar TO-2  
Man 339 TYPE V1/Z1  
Voith 55.6336 XXX  
VOLVO STD 1273.40/127.341  
FORD SQM9010B / M2C138CJ - M2C166H - M2C185A

REF		
RECATFU3	5 L	3
RECATFU6	1 L	6



### ACEITE PARA TRANSMISIÓN DEXRON III

Protege contra el desgaste, incluso a altas temperaturas. También proporciona muy buena protección contra la corrosión.  
NO DEBE USARSE DONDE SE RECOMIENDA API-GL5

### OIL FOR TRANSMISSION DEXRON III

Protects against wear, even at high temperatures. Also provides a very good corrosion protection.  
MUST NOT BE USED WHERE API-GL5 IS RECOMMENDED

### OLIO PER TRASMISSIONE DEXRON III

Protegge dall'usura, sempre ad alte temperature. Fornisce anche un'ottima protezione contro la corrosione.  
NON DEVE ESSERE UTILIZZATO DOVE VIENE RACCOMANDATO API-GL5

### HUILE POUR TRANSMISSION DEXRON III

Elle protège contre l'usure, même à des températures élevées. Elle offre également une excellente protection contre la corrosion.  
ELLE NE DOIT JAMAIS ÊTRE UTILISÉ LORSQUE L'API-GL5 EST RECOMMANDÉ

REF	OEM	
REC1161995	1161995	5 L

**VOLVO PENTA**



## TC-W3

### ACEITE MINERAL FUERABORDAS

El nuevo aceite anticarbonilla TC-W3 supera todos los requerimientos de garantía que los fabricantes de motores exigen. Utilize el TC-W3 para obtener mayor potencia en su motor. Provee de una mayor protección contra la carbonilla en los pistones, el resacamiento de los aros, el fallo de las bujías en el arranque y del óxido. Recomendado para los sistemas de inyección de aceite.

### 2-CYCLE OIL

Formulated from ultra-clean base stock oil to provide superior protection against piston scuffing, bearing wear, spark plug fouling, pre-ignition and rust. This formulation has outstanding lubricity and miscibility for better mixing of fuel and oil, resulting in a cleaner running engine. Contains no phosphorus. Recommended for oil injection systems. Outboard motor Oil.

### OLIO MINERALE PER FUORIBORDO

Il nuovo olio anticarbon TC-W3 supera tutti i requisiti di garanzia che i produttori di motori esigono. Utilizzare il TC-W3 per ottenere maggior potenza nel motore. Fornisce una maggiore protezione contro i residui di combustione nei pistoni, l'essiccazione delle fasce, il non funzionamento delle candele nell'accensione. Raccomandato per i sistemi di iniezione ad olio.

### HUILE MINERALE POUR HORS-BORD

Elle fournit une protection supérieure contre le serrage du piston, l'usure des roulements, l'encrassement des bougies d'allumage, le pré-allumage et la rouille. Elle a un pouvoir lubrifiant et une miscibilité exceptionnels pour un meilleur mélange du carburant et de l'huile, résultant d'un moteur plus propre. Recommandé pour les systèmes d'injection d'huile.

REF	OEM		
RM92-858021QB1U6	92-858021QB1	1 L	6
RM92-858022QB1U3	92-858022QB1	3,8 L	3
RM92-858023QB1U2	92-858023QB1	9,5 L	2

**QUICKSILVER**



RM92-858021QB1U6

RM92-858022QB1U3

RM92-858023QB1U2

## VARIOS

## VARIOUS

## VARI

## DIVERS

### ACEITE COMPRESOR

Especialmente probado en compresores Volvo Penta. Completamente sintético, resiste temperaturas altas y bajas. Protege el compresor contra la corrosión.

### COMPRESSOR OIL

Specially tested in Volvo Penta compressors. Fully synthetic oil that withstands both high and low temperatures. Protects compressor against corrosion.

### OLIO COMPRESSORE

Testati appositamente con i compressori Volvo Penta. Olio completamente sintetico che resiste alle alte e alle basse temperature. Protegge il compressore dalla corrosione.

### HUILE POUR COMPRESSEUR

Spécialement testé avec les compresseurs Volvo. Huile entièrement synthétique qui résiste aux températures élevées et basses. Protège le compresseur de la corrosion.

REF	OEM		VISCOSIDAD VISCOSITY VISCOSITA VISCOSITE
RM85108974	85108974	250 ml	ISO VG 68

**VOLVO PENTA**



ACEITE TRIM / TILT

POWER TRIM & TILT FLUID

OLIO TRIM / TILT

HUILE TRIM / TILT

REF		
RM92-858074QB1U12	240 ml	12



GRASA MARINA

MARINE GREASE

GRASSO MARINO

GRAISSE MARINE

GRASA MARINA. INSOLUBLE AL AGUA

MARINE GREASE. NON-WATER-SOLUBLE

GRASSO MARINO. INSOLUBILE IN ACQUA

GRAISSE MARINE INSOLUBLE DANS L'EAU

Grasa marina semisintética con base de litio-calcio, de cuerpo espeso y color azul. 100% insoluble al agua, especialmente formulada para todo tipo de aplicaciones náuticas incluso prensaestopas y hélices plegables, gracias a la buena adhesión al metal.

Semi-synthetic marine grease with a lithium and calcium base, thick and blue. 100% non-water-soluble, especially formulated for all nautical uses, including cable glands and foldable propellers, thanks to good adherence to metal.

Grasso marino semisintetico a base di litio-calcio, di aspetto denso e di colore azzurro. 100% insolubile in acqua, specificamente formulato per applicazioni nautiche di tutti i tipi, compresi premistoppa ed eliche pieghevoli, grazie all'alta aderenza ai metalli.

Graisse marine semi-synthétique à base de lithium-calcium, d'apparence dense et de couleur bleu clair. 100% insoluble dans l'eau, spécialement formulé pour tous les types d'applications nautiques, y compris les presse-étoupe et les hélices repliables, grâce à leur forte adhérence aux métaux.

REF		
RECGREU1	5 kg	1
RECGREU12	400 g	12



RECGREU12



RECGREU1

GRASA MARINA

MARINE GREASE

GRASSO MARINO



GRAISSE MARINE

Lubricante insoluble al agua, ideal para aplicaciones marinas. Excelente protección contra fricciones, óxido y corrosión.

Special calcium sulfonate complex, water insoluble formula ideal for marine applications. Provides excellent corrosion protection under severe conditions caused by salt water and air.

Lubrificante insolubile all'acqua, ideale per applicazioni marine. Eccellente protezione contro l'attrito, l'ossido e la corrosione.

Graisse insoluble dans l'eau, idéal pour les applications marines. Excellente protection contre le frottement, l'oxyde et la corrosion dans des conditions sévères causées par l'eau salée et l'air.



REF		PISTOLA GUN PISTOLA PISTOLET	
LUB11400	85g	RECT30190	3
LUB11402	400 g		1



LUB11400



LUB11402

REF		
RM92-8M0133989U6	280 g	6
RM92-8M0133985U4	450 g	4



RM92-8M0133985U4



RM92-8M0133989U6

GRASA DE LITIO

LITHIUM GREASE

GRASSO AL LITIO

GRAISSE AU LITHIUM

Grasa de litio con Teflón. Color blanco.

Heavy duty white lithium grease with Teflon.

Grasso al litio con Teflón. Colore bianco.

Graisse au lithium avec du Teflón. Couleur blanche.

REF	
LUB11363	350 ml



SOLUCIONES DE INSTALACIÓN • INTALATION SOLUTIONS • INTALAZIONE • SOLUZIONI INSTALLAZIONE • SOLUTIONS D'INSTALLATIONS



HERRAMIENTAS PARA GRASA

GREASE TOOLS

ATTREZZI PER GRASSO

OUTILS POUR GRAISSE

PISTOLA DE GRASA

LEVER GREASE GUN

PISTOLE GRASSO



POMPE A GRAISSE

Incluye manguera curvada y conector standard. Ideal para engrasar crucetas, cables de dirección, cañas de motor fuerborda, piñones y cualquier otra parte del motor que precise engrase. Con visor para reserva. Se recarga sin necesidad de tubo.

Standard Lever grease gun. Includes curved pipe and std coupler. Ideal for greasing spreaders, steering wires, rods outboard engine, gear bearing and other parts of the engine that needs greasing. With Viewer for reservation. Will reload without tube.

Include tubo flessibile curvo e connettore standard. Ideale per ingrassare cavi dello sterzo, barre del motore fuoribordo, ingranaggi e qualsiasi altra parte del motore che abbia bisogno di lubrificazione. Con visora per la prenotazione. Si ricarica senza tubo.

Comprend un tuyau incurvé et un connecteur standard. Idéal pour graisser les traverses, les câbles de direction, les tiges de moteur entraîné, les pignons et toute autre partie du moteur qui a besoin d'être graissée. Avec viseur pour réservation. Il se recharge sans tube.

REF			
RECT30201	600 cc	16000 psi	
LUB10212			30 cm

**RECMAR**



LUB10212



RECT30201

Pistola para tubos de grasa. Incluye manguera flexible de 14 cm y adaptador standard.

All purpose gun operates handy squeeze tubes. Includes 2-11/16" pipe and plastic push-type coupler.

Pistola per tubi di grasso. Include tubo flessibile da 14 cm e adattatore standard.

Pistolet pour tubes de graisse. Comprend un tuyau flexible de 14 cm et un adaptateur standard.

REF
RM91-37299Q2

**QUICKSILVER**



BOMBA EXTRACTORA

LOWER UNIT PAIL PUMP

POMPA ESTRATTRICE

POMPE D'EXTRACTION

Bomba extractora para bidones de aceite de 17 litros. REC80W9017L. Puede acoplarse directamente a las colas. Se suministra con adaptador roscado para las colas americanas habituales.

For bulk filing of lower units and stern drives. Designed to fit 17 L on per pails.

Pompa estrattrice per bidoni d'olio da 17 litri REC80W9017L. Si può collegare direttamente ai piedi. Si vende con adattatori per i piedi poppieri abituali.

Pompe d'extraction pour bidons d'huile de 17 litres REC80W9017L. Peut être directement couplé aux embases. Fourni avec un adaptateur fileté pour les embases américaines habituelles.

REF
LUB55011

**lubriMatic**





**KIT PISTOLA + GRASA**

Kit compuesto de una pistola pequeña y muy versátil que permite la salida del tubo conector frontal o superior. Presión máxima 300 k/cm<sup>2</sup>. Incluye un bloqueador para mantener el cartucho en posición y tubo de salida de 14 cm. Admite cartuchos de 3 onzas (85 g) o grasa a granel.

REF  
RECT30190  
**RECMAR®**

**MIDGET GREASE GUN KIT**

Marine corrosion control lubrication kit. Small, versatile gun allows for front or top pipe placement. Barrel takes 3 oz grease cartridge or can be bulk loaded. Develops up to 4,500 psi.



**KIT PISTOLA + GRASSO**

Kit composto da una pistola piccola e molto versatile che permette l'uscita del grasso dal tubo frontale o superiore. Pressione massima 300 k/cm<sup>2</sup>. Include un blocco per tenere la cartuccia in posizione, il tubo è da 14 cm. Utilizza cartuccia da 85 gr o grasso sfuso.

**KIT PISTOLET + GRAISSE**

Kit composé d'un petit pistolet très polyvalent qui permet la sortie du tube de connexion avant ou supérieur. Pression maximale 300 k / cm<sup>2</sup>. Il comprend un bloqueur pour maintenir la cartouche en position et un tube de sortie de 14 cm. Prend en charge des cartouches de 3 oz (85 g) ou de la graisse en vrac.

**PISTOLA DE ACEITE**

Pistola para acoplar en los envases de botella de 1 litro de LUB11552 y LUB11564. Se suministra con kit de adaptación con válvula anti-retorno.

**RECMAR®**



REC55133M

REC55133S

**BOTTLE GREASE PUMP**

Lower unit quart pump. Complete with metal threaded filler fitting.

**PISTOLA OLIO**

Pistola da accoppiare a bottiglie da 1 L LUB11552 e LUB11564. Si vende con kit di accoppiamento con valvola anti-ritorno.



**POMPE POUR HUILE**

Pompe pour les bidons de 1 litre de LUB11552 et LUB11564. Livré avec kit d'adaptation avec clapet anti-retour.



REF				
REC55005	Pistola de aceite	Bottle grease pump	Pistola olio	Pompe pour huile
REC55133M	Adaptador métrico (⊘ Suzuki)	Metric adaptor (⊘ Suzuki)	Adattatore metrico (⊘ Suzuki)	Adaptateur métrique (⊘ Suzuki)
REC55133S	Adaptador para Suzuki	Adaptor for Suzuki	Adattatore per Suzuki	Adaptateur Suzuki

**ADAPTADOR PARA EMBASES RECLUBE**

Para la pistola de aceite REC55005.

**ADAPTOR FOR RECLUBE CONTAINERS**

For REC55005 bottle grease pump.

**ADATTATORE PER CONTENITORI RECLUBE**

Per pistola olio REC55005.

**ADAPTATEUR POUR LES BIDONS DE 5L RECLUBE**

Pour le pistolet REC55005.

REF  
REC55006



**ACCESORIOS Y HERRAMIENTAS DE INSTALACIÓN**

**ACCESSORIES AND INSTALATION TOOLS**

**ACCESSORI E ATTREZZI ISTALAZIONE**

**ACCESSOIRES ET OUTILS D'INSTALLATION**

**BOMBA DEPÓSITO**

**GREASECASE FILLER**

**POMPA OLIO**

**POMPE DE REMPLISSAGE**

Para llenado de colas. Con válvula de ventilación para evitar derrames.

With check valve venting system to avoid overflow

Per mettere l'olio nei piedi poppier. Con valvola di sfianto per evitare fuoriuscite.

Pour le remplissage des embases. Avec valve de ventilation pour éviter les déversements.

REF				
REC55133GF	Bomba depósito	Greasecase filler	Pompa olio	Pompe de remplissage
REC55133M	Adaptador métrico (Suzuki)	Metric adaptor (Suzuki)	Adattatore metrico (Suzuki)	Adaptateur métrique (Suzuki)
REC55133S	Adaptador para Suzuki	Adaptor for Suzuki	Adattatore per Suzuki	Adaptateur Suzuki

**RECMAR®**



**KIT CAMBIO DE ACEITE**

**OIL CHANGE KIT**

**KIT CAMBIOE OLIO**

**KIT VIDANGE D'HUILE**

Bomba reversible, para cambio de aceite instalada sobre un bidón portátil de 13 l con mangueras de extracción y 2,5 m de cable eléctrico con pinzas.

Reversible pump kit for oil change, winterizing and liquid transfer. Hose kit and 3,5 gal. storage container.

Pompa reversibile, per cambio dell'olio installata sopra un bidone portatile da 13 lt con tubo di estrazione e 2,5 m di cavo elettrico con pinze.

Pompe réversible pour vidange d'huile installée au-dessus d'un sceau portable de 13 litres avec tube d'extraction et 2,5 m de câble électrique avec pince pour batterie

REF			
SH8050-305-426	14,1 l/min	12 V (4,7 A)	403 x 318 mm

**SHURflo®**



**BOMBA DE ACEITE MANUAL**

**MANUAL OIL PUMP**

**POMPA DELL'OLIO MANUALE**

**POMPE DE VIDANGE D'HUILE MANUELLE**

Incluye 3 tubos de Ø 9.8, 6.7 y 5.8 mm. Temperatura máxima 100°C. Cuando está lleno se para automáticamente.

With 3 tubes: Ø 9.8, 6.7 & 5.8 mm. Maximum temperature 100 °C. When full it automatically stops.

Incluye tubi da: Ø 9.8, 6.7 e 5.8 mm. Temperatura massima 100 °C. Quando pieno arresta automaticamente

Inclus les tubes Ø 9.8, 6.7 e 5.8 mm. Temperature max 100 °C. Arrêt automatique quand elle est pleine

REF			
GS20080	4 L	2.1 kg	496 x 204 mm
GS20081	6 L	2.4 kg	648 x 204 mm
GS20082	18 L	4.9 kg	700 x 350 mm

**OILBOX®**



REF	
GS20084	7 L
GS20085	9 L



**GOLDENSHIP**

GS20084 GS20085

Cuerpo de PVC y latón. Tubos de nylon flexible. Made of solid brass and PVC. Corpo in PVC e ottone. Tubo in nylon flessibile. Corps en PVC et laiton. Tuyau en nylon flexible.

REF
GS20151



**GOLDENSHIP**

Bomba extractora o trasvase de líquidos. Se acopla a los taladros eléctricos con portabrocas de 6 mm. Incluye manguera y tubo para aceite. Ideal for pumping water or oils. Includes 2,4 m hose. Drill shaft: 6 mm. Pompa estraitrice o per travaso di liquidi. Include tubo da 2,4m. Pompe d'extraction ou transfert de liquide. Se fixe aux perceuses électriques avec mandrin de 6 mm. Comprend un tuyau et un tube pour l'huile. 2,4m.

REF	
SH3010-000	760 l/h 200GPH



**SHURflo**

REF	0°	45°	90°	
LUB11957	4	2	2	M6x1



**LubriMatic**

REF	90°	
RECT11958	4	M6x1



**RECmar**

**KIT EXTRACTOR DE POLEAS** Extractor de polea contrapesos. Contiene 5 juegos de tornillos de diferentes medidas. **PULLER TOOL KIT** Harmonic ballancer puller. 5 sets of screws are provided. **KIT ESTRATTORE PULEGGE** Estrattore di pulegge. Contiene 5 kit di viti di differenti misure. **KIT EXTRACTEUR DE POULIES** kit d'outils facilitant l'extraction, de volants magnétiques, de volants de direction, de poulies et d'engrenages à trous taraudés.

REF
SSP4600



**RECmar**



Kit para extraer e instalar poleas.  
Para uso en todos los motores Ford, GM y Chrysler.  
También puede utilizarse para volantes de dirección y poleas en general.  
Esfuerzo máximo recomendado: 20 kg.

Harmonic ballancer puller and installation tool kit. Use on all Ford, GM & Chrysler engines.  
Heavy duty tool.  
Can also be used for steering wheels and pulleys

Kit per estrarre e installare pulegge in tutti i motori Ford, GM e Chrysler.  
Si può utilizzare per volani di direzione e pulegge in generale.  
Carico massimo: 20 kg.

Kit extracteur de balancier harmonique et trousse d'outils d'installation. A utiliser sur tous les moteurs Ford, GM et Chrysler.  
Outil robuste. Peut également être utilisé pour les volants et les poulies  
Charge maximale: 20kg.

REF  
SSPHBP100K  
**RECMAR®**



**EXTRACTOR FILTROS**

**OIL FILTER WRENCH**

**ESTRATTORE FILTRI**

**CLE A FILTRES**

REF  
REC70720 65 - 110 mm  
**RECMAR®**

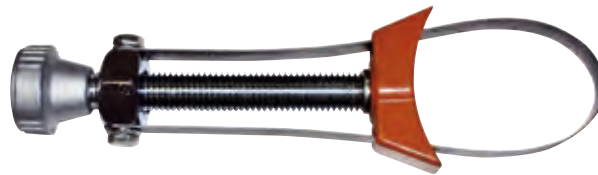

**JUEGO DE MACHOS**

**TAP AND DIE SET**

**FILIERA**

**JEU DE TARAUDS ET FILIERES**

Garantía de por vida.

Lifetime warranty.

Garantita a vita.

Garantie à vie.

REF  
CRA952343 Pulgadas  
Inches Pollici  
Pouces

**RECMAR®**



**LLAVE DINAMOMÉTRICA**

**TORQUE WRENCH**

**CHIAVE DINAMOMETRICA**

**CLE DYNAMOMETRIQUE**

Con escala en 20 - 150 pies/libras y 33.9 - 210 N.m  
Incrementos cada 1 pie/libra y 1,4 N.m  
Dado de conexión: 1/2"

Scale in 20-150 ft-lbs. 33.9 - 210 N.m  
Increases each 1 ft-lbs. & 1,4 N.m  
1/2" drive.

Con escala da 20 - 150 piedi /libra e 33.9 - 210 N.m  
Incremento di 1 pie / libra e 1,4 N.m  
Dado attacco: 1/2"

Avec échelle de 20 à 150 pieds / livre et 33,9 à 210 N.m  
Augmentation de 1 pied / livre et 1,4 N.m  
Embout de connexion: 1/2 "

REF  
CRA944595 518 x 35 x40 mm

**RECMAR®**



**FONENDOSCOPIO**

**SPARK GAP TESTER**

**FONENDOSCOPIO**

**PHONENDOSCOPE**

Instrumento de precisión, resistente a golpes, detecta fácilmente ruidos en motores, cojinetes y otras partes móviles. Incluye varilla de test, trompeta y auriculares.

Sensitive, shockproof instrument, easily locates noises in engines bearings and other moving parts. Includes aluminium alloy probe / needle, surgical PVC, rubber trumpet and plastic earphones.

Strumento di precisione, resistente a colpi, rileva facilmente rumori nel motore, nei cuscinetti e altre parti mobili. Include la tromba e gli auricolari.

Instrument de précision, résistant aux chocs, détecte facilement le bruit dans les moteurs, roulements et autres pièces mobiles. Comprend une tige d'essai, une trompette et des écouteurs.

REF  
REC91-00003  
**RECMAR®**





### OREJERAS REDONDAS

Tomos de agua para refrigeración de motores fueraborda y colas intra-fueraborda.

**GOLDENSHIP**

REF	
GS30350	1



### MOTOR FLUSHER ROUND

For use on most outboards and inboard/outboards engines with side water inlets.

### CUFFIE LAVAGGIO ROTONDE

Cuffie lavaggio per motori entrofuoribordo e fuoribordo.

USO PROFESIONAL  
PROFESSIONAL  
USO PROFESSIONALE  
USAGE PROFESSIONNEL

REF	
GS30351	1



### OREILLES DE RINÇAGE RONDES

Sorties d'eau pour le refroidissement du moteur hors-bord et in-bord.

### OREJERAS CUADRADAS

Tomos de agua para refrigeración de motores fueraborda y colas intra-fueraborda.

**GOLDENSHIP**

REF	
GS30352	1



### MOTOR FLUSHER SQUARE

For use on most outboards and inboard/outboards engines with side water inlets.

### CUFFIE LAVAGGIO QUADRATE

Cuffie lavaggio per motori entrofuoribordo e fuoribordo.

USO PROFESIONAL  
PROFESSIONAL  
USO PROFESSIONALE  
USAGE PROFESSIONNEL

REF	
GS30353	1

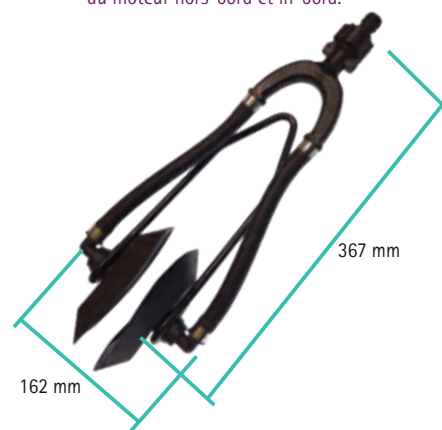

### OREILLES DE RINÇAGE CARREES

Sorties d'eau pour le refroidissement du moteur hors-bord et in-bord.

### EXTRACTOR IMPULSORES

Extractor para impulsores flexibles de bombas, motores fueraborda e interiores.

REF	
GS20198	Ø 65 mm 2-1/2"
GS20199	Ø 77 - 127 mm Ø 3" - 5"

**GOLDENSHIP**

### IMPELLER REMOVAL

Flexible impeller removal tool, suitable for all marine flexible impellers of water pumps, outboard and inboard engines.

### ESTRATTORE GIRANTE

Estrattore per giranti di pompe di motori fuoribordo e entrobordo.

### EXTRACTEUR DE TURBINE

Extracteur pour turbines flexibles, moteurs hors-bord et in-bord.



### LLAVE FRENO VOLANTE PARA FUERABORDAS

REF
REC5515100

**RECMAR**

### FLYWHEEL HOLDER PER OUTBOARDS

### CHIAVE FRENO VOLANTE PER FUORIBORDO

### CLÉ FREIN DE VOLANT POUR HORS-BORD



**EXTRACTOR COJINETES Y HÉLICES**

Extractor de cojinetes y hélices, con patas. Para todos los cojinetes Mercruiser y la mayoría de las hélices.

REF
REC90095

**RECMAR®**

**PROP AND BEARING PULLER**

Prop and bearing carrier puller. For Mercruiser All Style Bearing Carrier and Most Props.

**ESTRATTORE CUSCINETTI E ELICHE**

Estrattore cuscinetti e eliche. Per tutti i cuscinetti Mercruiser e la maggior parte delle eliche.

**EXTRACTEUR DE ROULEMENT ET D'HELICE**

Extracteur de roulements et hélices. Pour tous les roulements Mercruiser et la plupart des hélices.



Para hélices y cojinetes antiguos  
For prop and old style bearing carrier.  
Per eliche e cuscinetti vecchi.  
Pour hélices et roulements anciens



Para cojinetes modernos  
For new style bearing carrier.  
Per cuscinetti moderni.  
Pour roulements modernes

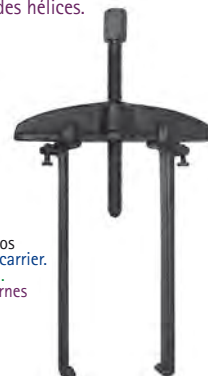

**EXTRACTOR PIÑONES Y COJINETES**

REF	
REC91-00001	30-50 mm 1 1/4" ~ 2 1/4"
REC91-00002	50-75 mm 2 1/4" ~ 3 1/2"
REC91-37241	75-105 mm 3" ~ 4 1/2"

**RECMAR®**

**UNIVERSAL PULLER PLATE**

**ESTRATTORE PIGNONE E CUSCINETTI**

**EXTRACTEUR DE PIGNON ET PALIER**



**CHISPÓMETRO**

Se puede comprobar la chispa con el motor en funcionamiento.

REF	CYL
REC5119766	8
REC004	1

**RECMAR®**

**SPARK GAP TESTER**

Good for checking spark on running engine.

**SCINTILLOMETRO**

Si può provare la scintilla con il motore in funzione.

**CONTRÔLEUR D'ALLUMAGE**

L'étincelle peut être vérifiée avec le moteur en marche.



REC5119766



REC004

**KIT ALARGADOR CABLE BUJÍAS**

REF		
REC5119902	18 cm	4
REC5119903	60 cm	4

**RECMAR®**

**EXTENSION WIRES**

**KIT PROLUNGA CAVI CANDELE**

**KIT EXTENSION DE FAISCEAU DE BOUGIE**



REC5119902





REC5119903

### KIT LLAVE HÉLICE

### PROP WRENCH KIT



### KIT CHIAVE ELICHA

### CLE POUR ECROU D'HELICE

REF	OEM		
REC91-859046Q4	91-821887T1	1 1/16"	75 - 300 HP



FLOTANTE | FLOATING | GALLEGIANTE | FLOTANT

REF	OEM		
REC91-859046Q3	91-859046Q3	15/16"	30, 40, 50 & 60 HP

RECmar®



### HERRAMIENTA AROS-PISTONES

Kit herramientas para la instalación de aros y pistones. Incluye 6 bandas de 7 a 11 cm.

### RING COMPRESOR KIT

Ring compressor kit for pistons. Includes 6 band 2-7/8" - 4-3/8"

### KIT FASCE-PISTONI

Kit per montare le fasce dei pistoni. Include 6 bande da 7 a 11 cm.

### KIT COLLIERS DE SERRAGE POUR SEGMENTS

Kit d'outils pour l'installation des segments et pistons. Il comprend 6 colliers de 7 à 11 cm.

REF
SSP4213

RECmar®



REF	
SSP4206	127 mm Ø 2-1/8" - 5" Ø
SSP4207	178 mm Ø 3-1/2" - 7" Ø

RECmar®



### JUEGO DE LLAVES

154 llaves en métrico y en pulgadas para un completo trabajo en motores. Garantía de por vida.

### MECHANICAL TOOL SET

154 pcs. Mechanics tool set in metric & inches. Lifetime warranty.

### CASSETTA ATTREZZI

154 chiavi metriche e in pollici per un lavoro completo nel motore. Garantita a vita.

### MALETTE D'OUTILLAGE

154 clés, métriques et en pouces pour un travail complet sur le moteur. Garantie à vie

REF
CRA935154



**EXTRACTOR TAPONES DE TRIM**

**TRIM PLUGS EXTRACTOR**

**ESTRATTORE PER TAPPI DI TRIM**

**EXTRACTEUR DE BOUCHON DE TRIM**

*new*

REF	RECTOOLTRIMKIT
	RECTOOLTRIM1 + RECTOOLTRIM2 + RECTOOLTRIM3



KITS DE RECAMBIO  
SPARE KITS  
KIT DI RICAMBIO  
KITS DE RECHANGE



REF	ÚTIL TOOL ATTREZZO UTILE			(A)
RECTOOLTRIM1	1/2"	+ RECPIN4	+ RECPIN4.5	38 mm
RECTOOLTRIM2	1/2"	+ RECPIN4	+ RECPIN4.5	32 mm
RECTOOLTRIM3	1/2"	+ RECPIN6		35 mm



REF		PARA FOR PER POUR
RECPIN4	3 PIN x 4 mm	RECTOOLTRIM1 RECTOOLTRIM1
RECPIN4.5	3 PIN x 4.5 mm	RECTOOLTRIM1
RECPIN6	3 PIN x 6 mm	RECTOOLTRIM3

Los pines de repuesto no tienen garantía.  
Replacement pins are not guaranteed.  
I perni di ricambio non sono garantiti.  
Les broches de remplacement ne sont pas garanties.



TRIM PISTON	TILT PISTON		HP
RECTOOLTRIM1		Yamaha	F25 - F40
RECTOOLTRIM2	RECTOOLTRIM3	Yamaha	F115 2000-14
RECTOOLTRIM2	RECTOOLTRIM3	Yamaha	F150 2004-10
RECTOOLTRIM2	RECTOOLTRIM1	Yamaha	F150 2011+
RECTOOLTRIM2	RECTOOLTRIM3	Yamaha	F175 - F200 (2.8L)
RECTOOLTRIM1	RECTOOLTRIM1	Yamaha	F200 - F250 (3.3L)
RECTOOLTRIM1	RECTOOLTRIM1	Yamaha	F225 - F300 (4.2L)
RECTOOLTRIM2	RECTOOLTRIM3	Yamaha	F350
RECTOOLTRIM2		Yamaha	F425
RECTOOLTRIM2		Yamaha	55-90 (2-Stroke) 1994+
RECTOOLTRIM2	RECTOOLTRIM3	Yamaha	115-200 + VMAX
RECTOOLTRIM1	RECTOOLTRIM1	Yamaha	225 (2-Stroke)
RECTOOLTRIM2	RECTOOLTRIM3	Suzuki	DF115 - DF300
RECTOOLTRIM2	RECTOOLTRIM3	Evinrude	115 - 300 ETEC
	RECTOOLTRIM3	Johnson Evinrude	25 - 50 (2 Strokes) 1994-04
RECTOOLTRIM2	RECTOOLTRIM3	Johnson Evinrude	60 - 250 (2 Strokes) 1982-06
RECTOOLTRIM2	RECTOOLTRIM3	Honda	75 - 225 1997+
	RECTOOLTRIM1	Seastar Steering	
	RECTOOLTRIM2	Volvo Penta Trim Cylinders	
	RECTOOLTRIM1	Mercuriser Alpha One Et Bravo Trim Cylinders	

**PULIDORA DE CILINDROS**

**ENGINE CYLINDER HONE**

**PULITRICE CILINDRI**

**RODOIR DE CYLINDRE**

Para pulir los cilindros de los bloques.  
Garantizada de por vida.

Quickly removes the glaze from engine  
cylinder walls before installing new  
piston rings.  
Lifetime warranty.

Per pulire i cilindri dei blocchi.  
Garantita a vita.

Poli les cylindres des blocs moteur.  
Garanti à vie.

REF	CRA904633
-----	-----------



REF	CRA946331
-----	-----------





**VACUÓMETRO DOBLE  
FUNCIÓN**

Presión y vacío.  
Ideal para comprobar las colas.

REF

REC55134

**RECMAR®**

**PRESSURE / VACUUM  
TESTER**

Combination unit that does pressure  
and vacuum testing in one units.  
Recommended to test drives.

**VACUOMETRO DOPPIA  
FUNZIONE**

Pressione e sottovuoto. Ideale per il  
controllo dei piedi.



**VACUOMÈTRE DOUBLE  
FONCTION**

Pression et vide.  
Idéal pour vérifier les embases.

**COMPRESÍMETRO**

Para motores gasolina con bases GM  
o Ford.

REF

CRA902171

**COMPRESSION TESTER KIT**

For gas engines with GM or Ford base.

**MANOMETRO**

Per motori benzina con base GM e  
Ford.



**COMPRESSIONIÈTRE**

Pour les moteurs à essence bases GM  
ou Ford.

**INTERRUPTOR ARRANQUE**

**REMOTE STARTER**

**INTERRUTTORE  
AVVIAMENTO**

**INTERRUPTEUR DE  
DÉMARRAGE A DISTANCE**

REF

CRA902175



**PISTOLA PUESTA A PUNTO**

**TIMING LIGHT**

Con regulador de avance 0-60.

0-60 advance scale.

**PISTOLA MESSA A PUNTO**

Con regolatore avanzamento 0-60.

**LAMPE STROBOSCOPIQUE**

Avec régulateur d'avance 0-60.

REF

CRA921023



**TERMÓMETRO MULTIFUNCIONAL**

Termómetro multifunción digital, por rayos infrarrojos. Retención de la última lectura. Autoapagado.

**INFRARED THERMOMETER**

Multifunction digital infrared thermometer. Retention of the last reading. Auto Off function.

**TERMOMETRO MULTIFUNZIONALE**

Termometro multifunzione digitale, a infrarossi. Memoria dell'ultima lettura. Autospegnimento.

**THERMOMÈTRE MULTIFONCTIONNEL**

Thermomètre multifonction numérique, par rayons infrarouges. Conservation de la dernière lecture. Arrêt automatique

REF
TECDT8580

Emisividad fija	Fixed emissivity	Misurazione	Mesure fixe	0,95 (-20°C-->+320°C)
Lectura en grados	Reading	Lettura in gradi	Lecture en degrés	Celsius Et Farenheit
Precisión	Precision	Precisione	Précision	+/- 2%
Resolución	Resolution	Risoluzione	Résolution	1°C
Distancia óptima de medida	Distancia optimal measurement	Distanza ottimale di misurazione	Distance de mesure optimale	6 --> 60 cm



**PINZA AMPERIMÉTRICA**

**AMPERIC NIPPER**

**PINZA AMPEROMETRICA**

**PINCE AMPÈREMÉTRIQUE**

Multifunción	multifunction	multifunzione	multifonction	AC Et DC (40A/400A)
Diámetro maxilar	aw diameter	Diametro max	Diamètre maxi	30 mm
Display	Display	Display	Affichage	3 <sup>3/4</sup> (Máx. 3999)
Precisión	Precision	Precisione	Précision	+/- (1,9% + 5 d. en AC) +/- (2,5% + 10 d. en DC)
Ancho de banda	Bandwidth	Banda larga	Bande passante	50Hz - 500Hz (AC)
Resolución	Resolution	Risoluzione	Résolution	AC/DC 10mA. 100mV.
Resistencia	Resistence	Resistenza	Résistance	400 Ohms

REF
TEC218



**TACÓMETRO ÓPTICO**

**OPTICAL TACHOMETER**

**TACOMETRO OTTICO**

**TACHYMÈTRE OPTIQUE**

Profesional portátil controlado por microprocesador y con base de tiempos de cristal de cuarzo de gran precisión. Retención de la última lectura en pantalla y registro lectura máxima y mínima del periodo de medida.

Professional portable microprocessor-controlled and with time base of quartz crystal of high precision. Retention of the latest reading on screen reading and record the maximum and minimum measurement period.

Professionale portatile controllata da un microprocessore e con display a cristalli di quarzo di alta precisione. Memoria dell'ultima lettura nello schermo e registro lettura massima e minima del periodo di misurazione.

Portable professionnel contrôlé par microprocesseur et avec base de temps de cristal de quartz de haute précision. Conservation de la dernière lecture sur l'écran de lecture et enregistrement de la période de mesure maximale et minimale.

REF				
TEC384	TACÓMETRO	TACHOMETER	TACOMETRO	TACHYMÈTRE OPTIQUE
TEC786	CINTA REFLECTANTE	REFLECTIVE TAPE	BANDA PER TACOMETRO	RUBAN RÉFLECTEUR
Medidor de RPM hasta	RPM meter up	Misura RPM fino	Compteur de tours jusqu'à	(-99.999)
Precisión	Precision	Precisione	Précision	+/- (0,05% + 1 d.)
Resolución	Resolution	Risoluzione	Résolution	0,1 (-9.999,9)
Distancia óptima de medida	Distancia optimal measurement	Distanza ottimale di misurazione	Distance de mesure optimale	50 --> 150 mm.
-en función de luz ambiente	-depending on ambient ligh	- con luce ambiente	-selon la lumière ambiente	-300 mm





MULTITESTER DIGITAL

DIGITAL MULTITESTER

MULTITESTER DIGITALE

MULTIMÈTRE DIGITAL

DISPLAY COUNT	1999
MANUAL RANGE	✓
DATA HOLD	✓
DIODE MEASUREMENT	✓
TRANSISTOR MEASUREMENT	✓
AUTO POWER OFF	✓
CONTINUITY BUZZER	✓
MECHANICAL PROTECTION	✓

POWER	9V (6F22*1)
PRODUCT COLOR	Blue and Gray
PRODUCT NET WEIGHT	340 g
PRODUCT SIZE	190x80x33 mm
STANDARD ACCESSORIES	Battery (not include) Test lead Temperature Probe
STANDARD INDIVIDUAL PACKING	Gift Box, Manual

		RANGE	BEST ACCURACY
DC VOLTAGE (V)	V $\overline{\text{—}}$	200mV ~ 1000V	$\pm (0.5\%+3)$
AC VOLTAGE (V)	V $\sim$	2V ~ 700V	$\pm (0.8\%+5)$
DC CURRENT (A)	A $\overline{\text{—}}$	20 $\mu$ A ~ 10A	$\pm (1.0\%+3)$
AC CURRENT (A)	A $\sim$	20mA ~ 10A	$\pm (1.2\%+5)$
RESISTANCE ( $\Omega$ )	$\Omega$	200 $\Omega$ ~ 200M $\Omega$	$\pm (0.8\%+3)$
CAPACITOR (F)	F	2nF ~ 200 $\mu$ F	$\pm (4.0\%+5)$
FREQUENCY (Hz)	Hz	200KHz	$\pm (1.5\%+10)$
TEMPERATURE (°C)	°C	-40°C ~ 1832 °C	$\pm (1.0\%+3)$
TEMPERATURE (°F)	°F	-40°C ~ 1832 °C	$\pm (1.0\%+3)$



REF  
TEC145

VACUÓMETRO SINCROZADOR

Vacuómetro, sincronizador de admisión, analizador dinámico de fugas y tacómetro. Impermeable e insubmergible con una funda especial. Posee mayor estabilidad que los indicadores analógicos o que cualquier otro sistema. Se autorregula a los cambios de presión barométrica. Alimentación con corriente continua de 12 V, se puede utilizar con cualquier batería de embarcación o vehículo o con un adaptador de entrada a la red (230V/12V). Indicadores LED de batería descargada y de alimentación no adecuada. Contiene: Cable y pinzas por alimentación 12V, tubos de santoprene de conexión, 2 juegos de adaptadores flexi-rigidos, caja de almacenaje.

REF  
TCMVRM5



VACUUMMATE ALLWEATHER

Vacuamate allweather, 4 x carb/ throttle valve. Waterproof. Shock resistant composite-moulded polyurethane and polycarbonate casing for maximum strength and resilience. Self-calibrates for barometric changes. Solid state sensors are drop proof. It has internal rechargeable 1,5Ah 7,2V NiMH batteries providing up to 6 hours autonomy. Battery power is conserved by auto-switch-off 5 minutes after last being used and LEDs use full power only when measurements are taken. Kit includes custom travel case, battery cord-set, T-connector & 2 full sets of unique flexi-rigid.

VACUOMETRO

Vacuometro, sincronizzatore d'aspirazione, analizzatore dinamico di fughe e tachimetro. Impermeabile e immergibile con una custodia speciale. Possiede maggiore sensibilità degli indicatori analogici o con altri sistemi. Si autoregola al cambio di pressione barometrica. Alimentazione con corrente continua da 12 V, si può utilizzare con qualsiasi batteria per imbarcazioni, veicoli e con un adattatore di entrata da 230V/12V. Indicatore LED di batteria scarica e di alimentazione non corretta. Contiene: Cavi e pinze per alimentazione 12V, tubi di santoprene di connessione, 2 adattatori flexi-rigidi, scatola per conservare l'attrezzo.

VACUUMMATE SYNCHRONISEUR

VacuMate affiche la pression d'admission individuelle de 4 carburateurs séparés (ou boîtier papillons à injection de carburant). Impermeable et insubmersible avec une housse spéciale. Il a une plus grande stabilité que les indicateurs analogiques ou tout autre système. Il autorégule les changements de pression barométrique. Alimentation 12 V DC, utilisable avec n'importe quelle batterie de bateau ou de véhicule ou avec un adaptateur secteur (230V/12V). Indicateurs LED de batterie déchargée et de puissance insuffisante. Contient: câble d'alimentation 12V et pinces, tubes de connexion, 2 jeux d'adaptateurs flexi-rigides, boîte de rangement.

**TABLET DE DIAGNOSIS**

**DIAGNOSIS TABLET**

**TABLET DIAGNOSI**

**TABLETTE DE DIAGNOSTIC**

**AXONE NEMO**

La primera diagnosis Smart en el mundo  
Axone Nemo es un potente tablet diseñado para asegurar al mecánico un óptimo uso, tanto en el entorno de taller, como en las intervenciones en el exterior. Permite efectuar operaciones de diagnóstico a gran velocidad. El chasis de magnesio le proporciona una mayor robustez y rigidez ante los golpes, muy ligero con gran capacidad de disipación de la temperatura interna.

The first Smart diagnosis in the world  
Axone Nemo is a powerful tablet designed to ensure the mechanic optimal use, both in the workshop environment, as interventions abroad. It allows to carry out diagnosis operations at high speed. The magnesium chassis provides greater robustness and rigidity against shock, very light with great capacity to dissipate the internal temperature.

La prima diagnosi Smart nel mondo  
Axone Nemo è un potente tablet creato per assicurare al meccanico un ottimo uso, sia nelle officine sia negli interventi all'esterno. Permette di effettuare operazioni di diagnosi a gran velocità. La scocca in magnesio gli dona una maggior robustezza contro i colpi, molto leggero. Il software operativo

Le premier outil de diagnostic intelligent au monde  
Axone Nemo est une tablette puissante conçue pour assurer une utilisation mécanique optimale, aussi bien dans un atelier que lors des interventions à l'extérieur. Il permet d'effectuer des opérations de diagnostic à grande vitesse. Le châssis en magnésium offre une plus grande robustesse contre les chocs, très léger avec une grande capacité à dissiper la température interne.

- 12" (2160 x 1440)
- Intel Quad Core N3160
- 8 GB RAM
- 250 GB
- WIFI double channel
- Bluetooth 4.0 Low Energy
- 2 camera x 5 Megapixels



**NAVIGATOR TXB EVOLUTION**

La evolución de la diagnosis, diseñado y desarrollado específicamente para el ambiente Marino.

The evolution of the diagnosis, designed and developed specifically for the marine environment.

L'evoluzione della diagnosi, disegnato e sviluppato specificamente per l'ambiente marino.

L'évolution du diagnostic, dessiner et développer spécialement pour l'environnement marin

Las características del hardware lo compatibilizan con todos los protocolos actualmente existentes, su conector CPC de 16 polos integrados, permite el uso de todos los cables de diagnóstico. Es compatible con AXONE NEMO y PC. Gracias a la tecnología Bluetooth el técnico podrá realizar una cómoda diagnosis sin cables de por medio, incluso desde el pantalán. Extremadamente potente, permite al mecánico una gestión fácil de los archivos de mapa. Los estándares CAN soportados incluyen la posibilidad de gestión CAN single wire y un CAN controller más para la diagnosis sobre más redes. Permite la grabación de la sesión de diagnosis en modalidad "pruebas dinámicas", es decir con la embarcación en movimiento, para localizar averías específicas que no se podrían verificar en el amarre.

The characteristics of the hardware make it compatible with all currently existing protocols, its integrated 16-pole CPC connector, allows the use of all diagnostic cables. It is compatible with AXONE NEMO and PC. Thanks to Bluetooth technology, the technician can make a comfortable diagnosis without wires, even from the jetty. Extremely powerful, they allow the mechanic to easily manage the map files. The CAN standards supported include the possibility of CAN single wire management and a further CAN controller for the diagnosis of more networks. It allows the recording of the diagnosis session in "dynamic tests" mode, that is to say with the boat in motion, to locate specific faults that could not be verified in the mooring.

Le caratteristiche hardware lo rendono compatibile con tutti i protocolli attualmente esistenti, il suo connettore CPC 16 poli integrato consente l'utilizzo di tutti i cavi diagnostici. È compatibile con AXONE NEMO e PC. Grazie alla tecnologia Bluetooth il tecnico potrà realizzare una diagnosi senza cavi in mezzo, anche dal molo. Estremamente potente, permette al meccanico una gestione facile degli archivi della mappa. Gli standard CAN supportati offrono la possibilità di gestire: CAN single wire e un altro CAN controller per eseguire le diagnosi su più reti. Permette la registrazione di una sessione di diagnosi in modalità "prova dinamica", ovvero con l'imbarcazione in movimento, per constatare avarie specifiche che non si possono verificare in officina.

Les caractéristiques du matériel le rendent compatible avec tous les protocoles existants, son connecteur CPC 16 pôles intégré permet l'utilisation de tous les câbles de diagnostic. Il est compatible avec Axone Nemo et Pc. Grâce à la technologie Bluetooth, le technicien peut effectuer un diagnostic sans fil, même depuis le quai. Extrêmement puissant, il permet au mécanicien de gérer facilement les fichiers des cartes. Les normes CAN prises en charge incluent la possibilité d'une gestion CAN à fil unique et un autre contrôleur CAN pour le diagnostic en réseaux. Il permet l'enregistrement de la séance de diagnostic en mode «test dynamique» c'est à dire avec le bateau en mouvement pour localiser des défauts spécifiques non vérifiables en atelier.

- SRAM 16 Mb
- MEMORY NAND Flash 8 GB
- BLUETOOTH



Ref				
RECAZONEVOICE	Axone Voice IDC5 Premium Marine + Navigator			
RECAZONE NEMO	Axone Nemo			
RECD06591	Navigator TXB Evolution			
RECD127X0	Axone Nemo + Navigator TXB Marine			
REZ06590PC	Navigator TXB + PC	Navigator TXB + Laptob	Navigator TXB + PC	Navigator TXB + Pc portable
REC3901775	Kit maleta para guardar cables de interface	Hand case for harnesses	Kit per cavi intergaccia	Valise pour ranger les câbles d'interface
RECA00M1	Contrato de actualización software (y renovación anual).	Software contract and annual renovation	Contratto software (e rinnovo annuale).	Contrat de mise à jour logicielle (et renouvellement annuel).



APLICACIONES	APPLICATIONS	APPLICAZIONI	APPLICATIONS
--------------	--------------	--------------	--------------

Consulte la lista actualizada de aplicaciones en:	See the updated list of applications in:	Vedi l'elenco aggiornato delle applicazioni in:	Consultez la liste mise à jour des applications sur:
---	--	---	--

[www.texaiberica.com/cobertura-diagnosis](http://www.texaiberica.com/cobertura-diagnosis)

MOTORES INTRABORDA   INBOARD ENGINES	MOTORS IN-BORD   MOTEURS IN-BORD
CATERPILLAR	3196, 3176, 3126B, 3508B, 3508C, C12, C12 Acert, C18 Acert Tier 2, C32 Acert IMO II, C32 Acert Tier 2, C32 Acert Tier 2 HP, 3512 B HD, C3512B, 3512C HD, 3512C, 3516B HD, 32 Acert Tier 2 H.P. Recreational, C32 Acert Tier 3, C7, C7 Acert, C9 Acert., 3516B, 3516C HD, 3516C, C15 Acert, C6.6 Acert
CRUSADER	5.0, 5.7, 6.0, 8.1 MPI & HO MPI
CUMMINS / MW	QSD2.0-115 / 130 / 150 / 170, QSD2.8-220, QSD4.2-270 / 320 / 350, QSB5.9 / 6.7, QSC8.3, QSK19, QSL9, QSM11 (Sistema Inyección Bosch   System injection Bosch   Sistema Iniezione Bosch   Système d'injection Bosch) Comon Rail
FIAT	C13, C78, C87, GE CURSOR 250E, 350E, 400E, N40, N60, N67, S30
FNM	HPEP, HPE 80-300 HP
HYUNDAI SEASALL	D150P/S, D170J/P/S, S220P/S, S250J/P/S, U125J/P/S
ILMOR	5.7L, 6.0L, 6.2L, MV-8
INDMAR	5.7, 6.0, 8.1, Steyr 256 Diesel
KOHLER	
LOMBARDINI Marine	LDW 194 JMT, LDW 240 JMT
MAN	D2868, V8-1000, V8-1200, 350, 377, 454, 496, 496MAG, 3.0L, 4.3L, 5.0L, 5.7L, 6.2L, 7.4L, 8.1L, 8.2L, TBI, MPI, Black Scorpion, Vazer, Mandos SmartCraft, D2.8D-Tronic
MERCURISER	VM D-Tronic, VM (no D-Tronic), MD2.0-115/130/150/170, MD2.8-270/320/350, TDI3.0-230/260, TDI4.2

MOTORES INTRABORDA   INBOARD ENGINES	MOTORS IN-BORD   MOTEURS IN-BORD
MERCURY Racing Inbord	SCI, EFI, QC4V, 500EFI, 520, 525EFI, 540, 565, 575, 600, 850, Scorpion 377
MTU	MDEC C2
PCM MARINE Engines	5.0L, 5.7L, 6.0L, 8.1L
PERKINS	1106C-E60TA 6.0L
SEA-DOO	Speedster, Challenger, Utopia, Islandia, Wake, Wake Speedster, Sportster
SISU AGCO	44 CTIM-2V, 49/66/74/84 CTIM-4V, MO306H43WJ, MO54NA33, MO84K32, MO94K33, MO114K33, MO126M28, MO144M38, MO156K25, MO164M40, MO166M28, MO174V40, MO196K35, MO236K42, MO256H45, MO256H43, MO286H43
STEYR MOTORS	SE126E25, SE156E26, SE196E35, SE236E40, SE236S36, SE266, SE286, SE306J38
VM MOTORI	2.8L, 4.2L D-Tronic, MD704, MD706, MR504LB
VOLKSWAGEN Marine	SDI, TDI
VOLVO PENTA	KAD, EDC, EGC, EVC, GXI, OSI, GI, GSI, OSXI, IPS, TAMD 4BY2-150 / 180, 6BY2-220 / 260 (Sistema Inyección Bosch   System injection Bosch   Sistema Iniezione Bosch   Système d'injection Bosch)
YANMAR	4BY3-150/180, 4JH, 6BY3-220/260, 6LY3, 8LV-320/350/370

MOTORES FUERABORDA   OUTBOARD ENGINES	MOTORS FUORIBORDO   MOTEURS HORS-BORD
EVINRUDE	(90 - 250 Ficht Ram) E-Tec 25 - 300 HP, DFI
HONDA Marine	BF 40-250 HP
JOHNSON	4 Stroke
MARINER	4 Stroke, OptiMax, Verado, DFI, EFI
MERCURY	4 Stroke, OptiMax, Verado, DFI, EFI
MERCURY Racing	OPTIMAX, DSi, VERADO 400R
PARSUN	40 EFI
SELVA Marine	4 S troke EFI
SUZUKI Marine	DF 40-300 HP
TOHATSU	MFS, BFW, BFT
YAMAHA Marine	F, T, Z 30 - 350 HP

MOTOS DE AGUA   PWC   MOTO D'ACQUA   JET-SKI	MOTOS D'ACQUA   JET-SKI
HONDA Marine	Aquatrax
KAWASAKI Marine	STX, Ultra.
SEA-DOO	GTI, GTX, RXP, RXT, GTR, GTS, GTX-S, Spark, Wake Pro, Wake
YAMAHA Marine	Waverunner FX, FZR, FZS, GP, VX



SIN CABLES DE INTERFACE   WITHOUT INTERFACE CABLE	SENZA CAVI INTERFACE	SANS CABLES D'INTERFACE
---	----------------------	-------------------------

REF		
REC3902417	OBD, FNM Marine, VOLKSWAGEN, HYUNDAI	AM08
REC3902659	Marine FPT	AM11
REC3904277	Marine CUMMINS, MERCURISER Diesel, KOHLER	AM24A
REC3905159	Marine VOLVO EGC 05/05>05/07	AM26
REC3905286	Marine MTU-MDEC	AM28
REC3905397	Marine CATERPILLAR, PERKINS	AM29
REC3906219	Marine TOHATSU	AM30
REC3906891	Marine MAN	AM31
REC3905015	Personal Water Craft KAWASAKI cable kit	



REC3902417      REC3902659



REC3905159  
Conector redondo  
Round connector  
Connettore rotondo  
Connecteur rond



REC3904277      REC3905286



REC3906891



REC3906219      REC3905015



SOLUCIONES DE INSTALACIÓN • INTALATION SOLUTIONS • SOLUZIONI INSTALLAZIONE • SOLUTIONS D'INSTALLATIONS



## INTERFACE AM01

REC3902358	AM01	
REC3902407	Marine HONDA / TOHATSU, PGM (FI)	AM02
REC3902247	Marine 2 pin MERCURY, MERCUISER	AM04
REC3902250	Marine 4 vie MERCURY, MERCUISER	AM05
REC3902413	Marine YAMAHA / SELVA	AM06
REC3909234	Marine 6 pin VOLVO PENTA	AM07
REC3902467	Marine VOLVO KAD - TAMD	AM09
REC3902864	Marine STEYR	AM12
REC3902865	Marine EVINRUDE	AM13
REC3902907	Marine VOLVO, MERCUISER 	AM14
REC3902931	MEFI-4, 4B, 3,2,1, CRUSADER	AM15
REC3903560	Marine YANMAR	AM22
REC3905265	Marine MERCUISER / VM D-Tronic	AM27
REC3908405	PARSUNS	3151/ AP54



REC3902247



REC3902407



REC3902413



REC3902250



REC3909234



REC3902467



REC3902865



REC3902864



REC3903560



REC3902907



REC3905265



REC3908405



REC3902931



## INTERFACE AM01CAN

REC3903008	AM01CAN	
REC3910120	Marine VOLVO, MERCUISER 	AM16
REC3903502	MEFI-5 / EGC, ILMOR, CRUSADER, ILMOR, INDMAR, PCM (MEFI-5/EGC UBD-Msocket)	AM18
REC3910127	Marine VOLVO, EGC-EV	AM25
REC3910127	Marine MERCURY, MARINER, CUMMINS 2010+, MANDOS MCM, SMARTCRAFT	AM32
REC3907103	Marine STEYR with CAN Line protocol	AM33
REC3907642	YANMAR MARINE CAN CABLE	



REC3910120



REC3903502



REC39004778



REC3907103



REC3907642

## KIT DIAGNOSIS Y REPROGRAMACIÓN DE LLAVE

REC3906015	BRP Group	3151/AP43	
------------	-----------	-----------	--

## PUNTAS DE DERIVACIÓN REFERRAL POINTS PUNTA DI DERIVAZIONE PONTS DE DÉRIVATION

REC3904048	AM10	
------------	------	---

Puede utilizarse con interface AM01 o AM01CAN dependiendo de la marca. It can be used with AM01 or AM01CAN interface depending on the brand. Può essere utilizzato con l'interfaccia AM01 o AM01CAN in base alla marca. Peut être utilisé avec l'interface AM01 ou AM01CAN selon la marque.



**RACORES Y TORNILLERÍA**

**RACORS & FITTINGS**

**RACCORDI E VITERIA**

**RACCORS ET VISERIE**

**CONDUCTO TAPON DESAGÜE**

**HOSE FITTING W/DRAIN**

**PLUG KIT CONDOTTO CON TAPPO**

**COUDE DRAIN POUR COLLECTEUR**

REF	OEM
REC862210A01	MC862210A01



**TAPON DRENAJE**

**DRAIN PLUG**

**RUBINETTO**

**BOUCHON DE VIDANGE**

REF	OEM	
REC82745	OMC379957 MC22-87238	1/4"
REC22-05154	MC22-16951Q1	3/4"



REC22-05154



REC82745

**TAPON COLECTORES**

**PIPE PLUG**

**TAPPI**

**BOUCHONS**

REF	OEM	
REC22-328022	22-32802	1/8 - 27
REC22-32803	M22-32803	3/8 - 18
BA50-090-075	22-33198A1	3/4 - 14
REC22-36382	22-36382	1/4 - 18



**TUERCAS**

**NUTS**

**DADI**

**ÉCROUS**

REF	OEM		
REC11-862903	11-82671013	3/8 - 24	Acero inox.   Stainless steel   Acciaio inox   Acier inox.
REC11-34933	11-34933	7/16 - 24	
REC11-8267089	11-35888	1/4 - 28	
REC11-13436	11-82670911	5/16 - 24	
REC11-52707Q1	11-52707Q1	3/4 - 16	



**RACORS DE LATÓN**

**RACORS IN BRASS**

**RACCORDI IN OTTONE**

**RACCORD EN LAITON**

REF			
GS31067	1/4" NPT	3/8" = 9,5 mm	2
GS31066	1/4" NPT	5/16" = 7,9 mm	2
REC22-00842	1/4" NPT	1/4" = 6,4 mm	
REC22-00845	1/8" NPT	5/16" = 7,9 mm	



REF			
GS31065	1/4" NPT	3/8" = 9,5 mm	2
GS31166	1/4" NPT	5/16" = 7,9 mm	2
GS31155	3/8" NPT	3/8" = 9,5 mm	2
GS31156	3/8" NPT	5/16" = 7,9 mm	2
GS31157	3/8" NPT	1/4" = 6,4 mm	2
GS31245	1/4"	1/4"	
REC22-00874	3/8"	3/8"	



**ENTRONQUE DE LATÓN**

**MALE PIPE IN BRASS**

**RACCORDI IN OTTONE**

**RACCORD EN LAITON**

REF			REF		
BRA125-3/16X1/4	3/16"	1/4"	BRA125-1/2X1/2	1/2"	1/2"
BRA125-1/4X1/4	1/4"	1/4"	BRA125-1/2X3/4	1/2"	3/4"
BRA125-1/4X3/8	1/4"	3/8"	BRA125-5/8X3/8	5/8"	3/8"
BRA125-1/4X1/2	1/4"	1/2"	BRA125-5/8X3/4	5/8"	3/4"
BRA125-5/16X3/8	5/16"	3/8"	RAC1/2X20	3/4"	1/2"
BRA125-3/8X3/8	3/8"	3/8"	BRA125-3/4X3/4	3/4"	3/4"
BRA125-3/8X1/2	3/8"	1/2"	BRA125-1X3/4	1"	3/4"
BRA125-1/2X3/8	1/2"	3/8"			



**SENSORES Y ALARMAS**

**SENDERS & ALARMS**

**SENSORI E ALLARMI**

**SONDES ET ALARMES**

**SENSOR PRESIÓN ACEITE**

**OIL PRESSURE SENDER**

**SENSORI PRESSIONE OLIO**

**SONDE DE PRESSION D'HUILE**

REF			
REC8M0068784	180 PSI	1/8" NPTF	USA
FA90519	100 PSI	1/8" NPTF	USA
FA90515	5 bar	1/8" NPTF	EURO
FA90526	10 bar	1/8" NPTF	EURO



**KIT TEMPERATURA Y PRESION DE ACEITE CON ALARMA**

**COMPLETE TEMPERATURE & OIL PRESSURE WARNING KIT**

**KIT TEMPERATURA E PRESSIONI DELL'OLIO CON ALLARME**

**KIT SONDE TEMPERATURE ET PRESSION D'HUILE**

REF
REC41400



**SENSOR TEMPERATURA**

**TEMPERATURE SENDER**

**SENSORI TEMPERATURA**

**SONDE DE TEMPERATURE**

REF	
REC97258A1	1/2" = 14 NPTF
FA90401	1/8" USA
FA90412	1/8" EURO



**MANGUERAS**

**HOSES**

**TUBO**

**TUYAUX**

**MANGUERA ESCAPE**

**EXHAUST HOSE**

**TUBO DI SCARICO**

**TUYAU D'ECHAPPEMENT**

Manguera de goma de espiral ondulada para sistemas de escape y refrigeración. Su particular estructura permite efectuar radio de curvatura de 1 a 1,5 vueltas por el diámetro interno.

General purpose hose. Hardwall corrugated cover rubber hose. Extremely flexible. The construction ensures bending radius up to 1 / 1.5 for the inside diameter.

Tubo in gomma spiralato ondulato per il sistema di scarico e raffreddamento. La sua particolare struttura consente di effettuare un raggio di curvatura da 1 a 1,5 giri per il diametro interno.

Tuyau d'échappement et de refroidissement en caoutchouc ondulé en spirale. Sa structure particulière lui garantit un rayon de courbure jusqu'à 1 / 1,5 de son diamètre intérieur

SCAMO / SP / CAJ

REF	Ø (mm)			
GS35033	30	30 mm		
GS35034	40	40 mm		
GS35045	45	45 mm		
GS35035	51	51 mm		
GS35036	60	60 mm		
GS35037	63,5	63,5 mm		
GS35038	76	76 mm		
GS35039	80	80 mm	-30°C → 100° C	x m
GS35040	90	90 mm		
GS35041	102	152 mm		
GS35042	120	240 mm		
GS35043	127	255 mm		
GS35044	152	305 mm		
GS35046	203	815 mm		
GS35047	254	1.270 mm		



Rina CE 0474  
Lloyd's Register 96/00/127

ISO 13363 - 2004 T-2 Class B  
SAE J 2006 - 2003 R2



**TUBO DE FIBRA**

**TUBING CONNECTOR**

**TUBO IN FIBRA DI VETRO**

**TUYAU EN FIBRE DE VERRE**

Tubo de fibra para empalme de mangueras en sistemas de escape húmedos. Bajo demanda, puede suministrarse hasta 457 mm.

Manufactured in fiberglass. Availables on demand up to 18".

Tubo in fibra di vetro. Disponibile sotto richiesta fino a 457mm.

Tuyau en fibre de verre. Disponible sur demande jusqu'à 457mm.

REF	Ø EXT (mm)		
TRI260-4001	102		
TRI260-4121	115	121°C	152 mm
TRI260-5001	127		
TRI260-6001	152		



## MANGUERAS DE MOTOR Y CODOS DE SILICONA

Diseñadas para aplicación marina, de paredes duras, son resistentes a elevadas temperaturas (hasta 177 °C) que poseen, a su vez, una gran flexibilidad. De interiores suaves al igual que los arcos de los fuelles y codos son de color azul. Absorben mejor los movimientos del motor, la vibración y el ruido. Son las standard en los grandes yates. Cumple las normas SAEJ2006, ABYC P1, NMMA.

### BENEFICIOS

Su instalación es mejor y más fácil; resuelve los problemas de espacio, obstrucción y desvío, en menos tiempo y con menos costes. Reduce la presión posterior del motor. Alarga la vida del sistema de escape y de la embarcación. .

## ENGINE HOSES AND ELBOW IN SILICONE

Heavy-wall construction and best rubber & silicone formulations. Resistance up to 350°F. Excellent flexibility and tight bend radius design. Smooth interior surface & bend arcs. Maximum absorption of engine movement, vibration and noise. Complies with new SAEJ2006, ABYC P1, NMMA standards.

### BENEFITS

Solves the tough marine exhaust system problems. Easier and better installations. Solves misalignment, obstruction & space problems with less labor, parts & cost. Reduce engine back pressure. Smoother, quieter operation. Extends life of exhaust system & boat.

## TUBI MOTORI E GOMITI IN SILICONE

Costruiti per uso marino, di materiale resistente, anche alle alte temperature (fino a 177°C). Flessibili. Sia gli interni che gli esterni, dei tubi e dei gomiti sono di colore azzurro. Assorbono meglio i movimenti del motore, le vibrazioni e il rumore. Sono standard nei grandi yachts. Normativa SAEJ2006, ABYC P1, NMMA.

### BENEFICI:

Di facile installazione: risolve il problema dello spazio, ostruzioni e deviazioni, in meno tempo e meno costi. Riduce la pressione posteriore del motore, migliora il suo rendimento e riduce la spesa nei pezzi di ricambio.

## TUYAU MOTEUR ET COUDE EN SILICONE

Conçu pour une utilisation marine, en matériau résistant, même à des températures élevées (jusqu'à 177 ° C). Excellente flexibilité et sa conception permet d'avoir de faibles rayons de courbure. Absorption maximale des mouvements du moteur, des vibrations et du bruit. Ils sont installés en standard dans les grands yachts. Normes SAEJ2006, ABYC P1, NMMA.

### AVANTAGES:

Facile à installer, il résout les problèmes d'alignement, d'obstruction et d'espace avec moins de main-d'œuvre, de pièces et de coûts. Fonctionnement plus fluide et plus silencieux. Prolonge la durée de vie du système d'échappement et du bateau

### CODO 90° DE SILICONA

Bajo demanda, puede suministrarse hasta 10" (254 mm).

REF	Ø INT
TRI290V-3000	76 mm 3"
TRI290V-4000	102 mm 4"
TRI290V-4500	115 mm 4 1/2"
TRI290V-5000	127 mm 5"
TRI290V-6000	152 mm 6"



### 90° ELBOW IN SILICONE

Available on demand up to 10" (254 mm.)



### GOMITO 90° IN SILICONE

Sotto richiesta si può avere fino a 10" (254mm)

### VHT

REF	Ø INT	177°C
TRI292V2000	51 mm 2"	
TRI292V2120	63 mm 2 1/2"	

### COUDE À 90° EN SILICONE

Disponible sur demande jusqu'à 10" (254mm)



### CODO 45° DE SILICONA

### VHT

REF	Ø INT	177°C
TRI242V-2000	51 mm 2"	
TRI240V-3000	76 mm 3"	
TRI240V-3500	90 mm 3 17/32"	
TRI240V-4000	102 mm 4"	
TRI240V-6000	152 mm 6"	



### GOMITO 45° IN SILICONE

### COUDE À 45° EN SILICONE



### FUELLE DE SILICONA

Bajo demanda, puede suministrarse hasta 10" (254 mm).

REF	Ø INT	Ø EXT
TRI270V-4000	102 mm 4"	133 mm 5 1/4"
TRI270V-4500	115 mm 4 1/2"	133 mm 5 1/4"
TRI270V-5000	127 mm 5"	152 mm 6"
TRI270V-6000	152 mm 6"	177 mm 7"



### SOFFIETTO IN SILICONE

Sotto richiesta si può avere fino a 10" (254mm)

### SOUFFLET EN SILICONE

Disponible sur demande jusqu'à 10" (254mm)



**MANGUERA DE ESCAPE DE SILICONA**

**EXHAUST & WATER HOSE IN SILICONE**

**TUBO DI SCARICO IN SILICONE**

**TUYAU D'ÉCHAPPEMENT ET D'EAU EN SILICONE**

REF	Ø INT	
TRI202V-4004	102 mm 4"	50 cm
TRI202V-5004	127 mm 5"	50 cm
TRI202V-6004	152 mm 6"	50 cm
TRI202V-8004	203 mm 8"	50 cm



Bajo demanda, puede suministrarse hasta 18" (457 mm).

Available on demand up to 18" (457 mm.)

Sotto richiesta si può avere fino a 18" (457mm)

Disponibile sur demande jusqu'à 18" (457mm)

REF	Ø INT	
TRI252V0340-36	19 mm 3/4"	30 cm 1'
TRI252V1000-36	25 mm 1"	30 cm 1'
TRI252V1140-36	32 mm 1 1/4"	30 cm 1'
TRI252V1120-36	38 mm 1 1/2"	30 cm 1'
TRI252V1340-36	45 mm 1 3/4"	30 cm 1'



**LLAVE DE ARRANQUE**

**IGNITION STARTER SWITCHES**

**CHIAVE DI AVVIAMENTO**

**CONTACTEUR À CLÉ**

3 posiciones con retroceso, Off-Contacto-Arranque. Fabricada en latón con frontal cromado. Chrome plated brass face nut and brass back-up nut.

3 positions with return, Off-Ignition-Start.

3 posizioni con ritorno Off-Contatto-Avviamento. In ottone con frontale cromato.

3 positions, Off-Contact-Start. Fabriqué en laiton avec façade chromée. Écrou frontal en laiton chromé et écrou d'appui en laiton.

REF	A			
GS11150	28 mm	3, 15A 12V	3	1

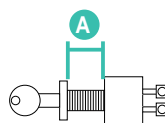

Fabricada en latón con frontal protector de goma. 3 posiciones con retroceso, Off-Contacto-Arranque.

Made in brass with rubber cap protector. 3 positions with return, Off-Ignition-Start.

Prodotta in ottone con parte frontale in gomma, 3 posizioni con ritorno, Off-Contatto-Avviamento.

En laiton avec façade de protection en caoutchouc. 3 positions: Off-Contact-Start.

REF			
GS11151	3	3	1
GS11154	4	3	1



Plástico con frontal protector de goma. 3 posiciones con retroceso, Off-Contacto-Arranque.

Made in plastic with rubber cap protector. 3 positions with return, Off-Ignition-Start.

In plastica con parte frontale in gomma 3 posizioni con ritorno, Off-Contatto-Avviamento.

Plastique avec façade de protection en caoutchouc. 3 positions: Off, contact et démarrage.

REF	A			
GS11152	15 mm	3	3	1

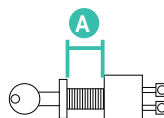



Plástico con frontal protector de goma.  
3 posiciones con retroceso, Off-Contacto-Arranque.

Made in plastic with rubber cap protector.  
3 positions with return, Off-Ignition-Start.

In plastica con parte frontale in gomma 3 posizioni con ritorno, Off-Contatto-Avviamento.

Plastique avec façade de protection en caoutchouc.  
3 positions : Off, contact et démarrage.

REF			
GS11153	5	3	1





 GOLDENSHIP

Plástico.  
4 posiciones con retroceso, Accesorios-Off-Contacto-Arranque.

Made in plastic with rubber cap protector.  
4 positions with return, Acc-Off-Ignition-Start.

Prodotta in plastica.  
4 posizioni con ritorno, Blower-Off-Contatto-Avviamento.

Plastique  
4 positions avec retour, Accessoires-Off-Contact-Start.

REF			
GS11155	15 mm = 5/8"	7	4
GS11156	6 mm = 1/4"	7	4

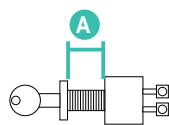



 GOLDENSHIP

Fabricada en plástico.  
3 posiciones con retroceso, Off-Contacto-Arranque (Starter).

Made in plastic. 3 positions with return, Off-Ignition-Start (Choke).

Prodotta in plastica. 3 posizioni con ritorno, Off-Contatto-Avviamento (Starter).

En plastique.  
3 positions avec retour, démarreur sans contact.

REF			
GS11158	15 mm = 5/8"	6	3
GS11157	6 mm = 1/4"	6	3

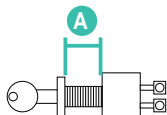



 GOLDENSHIP

Fabricada en plástico.  
Con cables incluidos.  
3 posiciones con retroceso, Off-Contacto-Arranque (Starter).

Made in plastic.  
3 positions with return, Off-Ignition-Start (Choke).  
With wires included.

Prodotta in plastica.  
Con cavi inclusi.  
3 posizioni con ritorno, Off-Contatto-Avviamento (Starter).

En plastique.  
Avec câbles inclus.  
3 positions avec retour, démarreur sans contact.

REF			
GS11159	6	3	1



 GOLDENSHIP

**IDENTIFICACIÓN MOTOR**

**ENGINE'S IDENTIFICATION**

**IDENTIFICAZIONE MOTORE**

**IDENTIFICATION MOTEUR**

**ROTACIÓN ESTÁNDAR**  
**STANDARD ROTATION**  
**ROTAZIONE STANDAR**  
**ROTATION STANDARD**

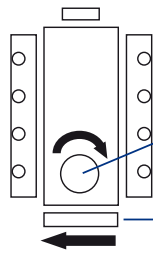

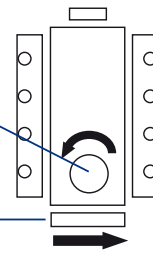

**DISTRIBUIDOR**  
**DISTRIBUTOR**  
**DISTRIBUTORE**  
**DISTRIBUTEUR**

**VOLANTE**  
**FLYWHEEL**  
**VOLANTE**  
**VOLANT**

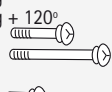

**CONTRAROTACIÓN**  
**CCW ROTATION**  
**CONTRO ROTAZIONE**  
**CONTRAROTATION**

MODELO MODEL MODELE	BASE	CYL	C.C.	Ø PISTÓN Ø PISTONE Ø PISTON	COJINETE BIELA BEARING CONNECTING ROD BRONZINE BIELLA ROULEMENT DE BIELLE	COJINETE BANCADA BEARING CRANKSHAFT BRONZINE BANCO ROULEMENT DE VILEBREQUIN	APRIETE DE MOTOR kg/m   TORQUE ENGINE kg/m   DATI DI SERRAGGIO kg/m   SERRAGE DU MOTEUR kg/m		BIELA CONNECTING ROD BIELLA BIELLE	CIGÜEÑAL CRANKSHAFT ALBERO MOTORE VILEBREQUIN
							CULATA HEAD TESTATA CULASSE	VOLANTE FLYWHEEL VOLANO VOLANT		
<b>CHRIS-CRAFT</b>										
185	GM 283	V8	4.6 L	98.42	50.80	58.38	8.8	8.2	4.5	9.5
200 - 215	GM 307	V8	4.9 L	98.42	53.34	62.19	8.8	8.2	6.2	9.5
200 - 225	GM 305	V8	5.0 L	95.00	53.34	62.19	8.8	8.2	6.2	9.5
210 - 230	GM 327	V8	5.4 L	101.60	53.34	62.19	8.8	8.2	6.2	9.5
250 - 300	GM 350	V8	5.7 L	101.60	53.34	62.19	8.8	8.2	6.2	9.5
330	GM 454	V8	7.4 L	108.00	55.88	69.81	10.8	6.2	6.8	10.8
<b>CRUSADER- RIVA</b>										
185	GM 283	V8	4.6 L	98.42	50.80	58.38	8.8	8.2	4.5	9.5
190 - 220 - 210	GM 305	V8	5.0 L	95.00	53.34	62.19	8.8	8.2	6.2	9.5
200	GM 307	V8	5.0 L	98.42	53.34	62.19	8.8	8.2	6.2	9.5
210-225-230-250	GM 327	V8	5.3 L	101.60	53.34	62.19	8.8	8.2	6.2	9.5
265 - 270 - 350	GM 350	V8	5.7 L	101.60	53.34	62.19	8.8	8.2	6.2	9.5
320	GM 427	V8	7.0 L	108.00	55.88	69.81	10.8	6.2	6.8	10.8
320-350-355-365	GM 454	V8	7.4 L	108.00	55.88	69.81	10.8	6.2	6.8	10.8
380	GM 502	V8	8.2 L	113.43	55.88	69.81	10.8	6.2	6.8	14.9
<b>MERCURUISER</b>										
120	GM 153	L4	2.5 L	98.42	50.80	58.38	12.5-13.8	8.2 - 8.8	4 - 4.5	8.2 - 9.5
140	GM 181	L4	3.0 L	101.60	53.34	58.38	12.5-13.8	8.2 - 8.8	4 - 4.5	8.2 - 9.5
170-180-190-470	GM 224	L4	3.7 L	110.74	63.44	69.77				
165	GM 250	L6	4.0 L	98.42	50.80-53.34	58.38	12.5-13.8	8.2 - 8.8	4 - 4.5	8.2 - 9.5
175 - 205	GM 262	V6	4.3 L	101.60	57.14	62.19	8.8	8.2	6.2	9.5
898-200-228-230	GM 305	V8	5.0 L	95.00	53.34	62.19	8.8	8.2	6.2	9.5
250-260-270-280	GM 350	V8	5.7 L	101.60	53.34	62.19	8.8	8.2	6.2	9.5
300 - 320 - 350	GM 350	V8	5.7 L	101.60	53.34	62.19	8.8	8.2	6.2	9.5
6.2	GM 377	V8	6.2 L	101.60	53.34	62.19	1° ⇨ 3.5 2° ⇨ 6 3° ⇨ 9	10	1° ⇨ 2.7 Kg 2° ⇨ 45°	1° ⇨ 2K 2° ⇨ 73° 3° ⇨ 2K 4° ⇨ 43° 5° ⇨ 73°
325	GM 427	V8	7.0 L	108.00	55.88	69.81	10.8	6.2	6.8	10.8
330-370-400-425	GM 454	V8	7.4 L	108.00	55.88	69.81	10.8	6.2	6.8	10.8
8.1	GM 496	V8	8.1 L	108.00		69.81	1° ⇨ 3 kg 2° ⇨ 3 kg + 120° 3° ⇨ 60°	10	1° ⇨ 3 Kg 2° ⇨ 90°	1° ⇨ 3k 2° ⇨ 90°
500 - 502	GM 502	V8	8.2 L	113.43	55.88	69.81	10.8	6.2	6.8	14.9
215 - 225 - 888	FD 302	V8	5.0 L	101.60	53.94	57.12	8.8-9.8	10.2 - 11.5	2.5 - 3.3	8.2 - 9.5
233 - 255	FD 351	V8	5.8 L	101.60	58.70	76.21	14.2-15.2	10.2 - 11.5	5.5 - 6	13 - 14
<b>OMC</b>										
120	GM 153	L4	2.5 L	98.42	50.80	58.38	12.5-13.8	8.2 - 8.8	4 - 4.5	8.2 - 9.5
140	GM 181	L4	3.0 L	101.60	53.34	58.38	12.5-13.8	8.2 - 8.8	4 - 4.5	8.2 - 9.5
165	GM 250	L6	4.0 L	98.42	50.80-53.34	58.38	12.5-13.8	8.2 - 8.8	4 - 4.5	8.2 - 9.5
155	GM 225	V6	3.6 L	95.25	50.80	63.50	9 - 11	6.2 - 6.9	4.2 - 5.5	13.2-16.5
170	GM 229	V6	3.8 L	95.00	53.34	62.19	8.8	8.2	6.2	9.5
175	GM 231	V6	3.8 L	96.52	57.14	63.50	8.8	8.2	6.2	9.5
205	GM 262	V6	4.3 L	101.60	57-14	62.19	8.8	8.2	6.2	9.5
185-200-210-220	GM 305	V8	5.0 L	95.00	53.34	62.19	8.8	8.2	6.2	9.5
250-260-270-290	GM 350	V8	5.7 L	101.60	53.34	62.19	8.8	8.2	6.2	9.5

MODELO MODEL MODELLO MODELE	BASE	CYL.	C.C.	Ø PISTÓN Ø PISTON Ø PISTONE Ø PISTON	COJINETE BIELA BEARING CONNECTING ROD BRONZINE BIELLA ROULEMENT DE BIELLE	COJINETE BANCADA BEARING CRANKSHAFT BRONZINE BANCO ROULEMENT DE VILEBREQUIN	APRIETE DE MOTOR kg/m   TORQUE ENGINE kg/m   DATI DI SERRAGGIO kg/m   SERRAGE DU MOTEUR kg/m		BIELA CONNECTING ROD BIELLA BIELLE	CIGÜENAL CRANKSHAFT ALBERO MOTORE VILEBREQUIN
							CULATA HEAD TESTATA CULASSE	VOLANTE FLYWHEEL VOLANO VOLANT		
310 - 330 - 335	GM 454	V8	7.4 L	108.00	55.88	69.81	10.8	6.2	6.8	10.8
160 - 175 - 190	FD 302	V8	5.0 L	101.60	53.94	57.12	8.8 - 9.8	10.2 - 11.5	2.5 - 3.3	8.2 - 9.5
235 - 240 - 250	FD 351	V8	5.8 L	101.60	58.70	76.21	14.2-15.2	10.2 - 11.5	5.5 - 6	13 - 14
295 - 340	FD 460	V8	7.5 L	110.70	63.24	75.95				
<b>VOLVO</b>										
3.0GL - 3.0GS	GM 181	L4	3.0 L	101.60	53.34	58.38	12.5-13.8	8.2 - 8.8	4 - 4.5	8.2
155	GM 225	V6	3.6 L	95.25	50.80	63.50	9 - 11	6.2 - 6.9	4.2 - 4.5	13.2 - 16.5
175	GM 229	V6	3.8 L	95.00	53.34	62.19	8.8	8.2	6.2	9.5
205-431-432-434	GM 262	V6	4.3 L	101.60	57.14	62.19	8.8	8.2	6.2	9.5
200-211-225-231	GM 305	V8	5.0 L	95.00	53.34	62.19	8.8	8.2	6.2	9.5
500 - 501	GM 305	V8	5.0 L	95.00	53.34	62.19	8.8	8.2	6.2	9.5
255-260-261-271	GM 350	V8	5.7 L	101.60	53.34	62.19	8.8	8.2	6.2	9.5
280-290-311-570	GM 350	V8	5.7 L	101.60	53.34	62.19	8.8	8.2	6.2	9.5
740-7.4GL-7.4Gi	GM 454	V8	7.4 L	108.00	55.88	69.81	10.8	6.2	6.8	10.8
8.1	GM 496	V8	8.1 L	108.00		69.81	1º ⇨ 3 kg 2º ⇨ 3 kg + 120º 3º ⇨ 60º 	10	1º ⇨ 3 Kg 2º ⇨ 90º	1º ⇨ 3k 2º ⇨ 90º 
8.2GL-8.2GSi	GM 502	V8	8.2 L	113.43	55.88	69.81	10.8	6.2	6.8	14.9
190-5.0FL-5.0Fi	FD 302	V8	5.0 L	101.60	53.94	57.12	8.8-9.8	10.2 - 11.5	2.5 - 3.3	8.2 - 9.5
240-5.8FL-5.8Fi	FD 351	V8	5.8 L	101.60	58.70	76.21	14.2-15.2	10.2 - 11.5	5.5 - 6	13 - 14
B 18		L 4	1.8 L	84.14	54.08	63.44	9	5	5.5	12.5
B 20		L 4	2.0 L	88.90	54.08	63.44	9	5	5.5	12.5
B 21		L 4	2.1 L	92.00	54.08	63.44	9	7.2	6.2	10.8
B 23		L 4	2.3 L	96.00	54.08	63.44	10.8	7.2	6.2	10.8
B 25		L 4	2.5 L	96.00	48.98	54.98	2+4+120º	7	2 + 90º	11
B 30		L 6	3.0 L	88.90	54.08	63.44	9	5	5.5	12.5
MD 1 A		L 1	0.445 L	79.37						
MD 1 B		L 1	0.560 L	88.90	53.96	66.64	11	70	6.5	4.5
MD 2 A		L 2	0.890 L	79.37						
MD 2 B		L 2	1.12 L	88.90	53.96	66.64	11	70	6.5	4.5
MD 3 B		L 3	1.168 L	88.90	53.96	66.64	11	70	6.5	4.5
MD 5		L 1	0.443 L	84.00	51.00	54.00	7	50	7	7
MD 6		L 2	0.631 L	70.00	50.00	50.00	7	18	5	5
MD 7 A		L 2	0.744 L	76.00	50.00	50.00	7	18	5	5
MD 7 B		L 2	0.744 L	76.00	50.00	50.00	7	18	5	5
MD 11		L 2	1.12 L	88.90	53.96	66.64	11	50	6.5	4.5
MD 17		L 3	1.68 L	88.90	53.96	66.64	11	59	6.5	4.5
MD 21		L 4	2.112 L	90.00	49.99	55/55.19	7	6.5	6	10
D 30		L 4	2.39 L	92.00	56.48	69.98	13	11.5	11.3	14
D 31		L 4	2.39 L	92.00	56.48	69.98	13	11.5	11.3	14
D 32		L 6	3.17 L	90.00	49.99	55/55.19	7	6.5	6	10
D 40		L 6	3.59 L	92.00	56.48	69.98	13	11.5	11.3	14
D 41		L 6	3.59 L	92.00	56.48	69.98	13	11.5	11.3	14
D 42		L 6	3.59 L	92.00	56.48	69.98	13	11.5	11.3	14
2001		L 1	0.43 L	79.00	48.00	60.00	2 - 7	6.5	7	2 - 6
2002		L 2	852	79.00	48.00	60.00	2 - 7	6.5	7	2 - 6
2003		L 3	1.278 L	79.00	48.00	60.00	2 - 7	6.5	7	2 - 6
2003 T		L 3	1.278 L	79.00	48.00	60.00	2 - 7	6.5	7	2 - 6
D1-13A		2	0,51L	67		23	36,5	74	23	27
D1-20A		3	0,76L	67		23	36,5	74	23	27
D1-30A		3	1,13L	77		23	51	74	32	27
D2-40A		4	1,51L	77		23	51	74	32	27
MD2010		2	0,45L	67	21-26	25-30	35-40	70-80		
MD2020		3	0,68L	67	21-26	25-30	35-40	70-80		
MD2030		3	0,95L	75	30-35	25-30	50-53	60-70		
MD2040		3	1,50L	84	50-55	50-55	90-95	60-70		
D2-55/75		4	2,2L	84	49-54	49-54	98-103	69-78		
D3		5	2,4L	81			50 + 90º+ 90º	45 + 65º		
D4		4	3,67	103			150 + 180º + 90º	100 + 45º	65 + 90º	
D5		4	4,76	108		50+60º+60º	130 + 90º	30+60º+60º		30+ 60º + 60º
D6		6	5,5	103			150 + 180º + 90º	100 + 45º	65 + 90º	
D7		6	7,15	108		50+60º+60º	130 + 90º	30+60º+60º		30+ 60º + 60º

# GM

## BASE MOTORES GM NUEVOS

## GM BASE NEW ENGINES



## BASE MOTORE GM NUOVO

## MOTEURS BASE GM NEUF

### 181 STANDARD 3.0 L & 3.0 LX

REF	OEM
RECGM181	MERCUISER: 864G26A01, 864G26A02 VOLVO PENTA: 3857760 OMC CRUSADER INDMAR (1991+)



CUBICAJE	DISPLACEMENT	CILINDRATA	CYLINDRÉE	3.0L (181 CID)
POTENCIA CIGÜEÑAL	HORSE POWER	POTENZA ALL'ALBERO MOTORE	PUISSANCE AU VILEBREQUIN	140 HP @ 4800 rpm
TORSIÓN	TORQUE	TORCENTE	COUPLE	117 lb-ft @ 3600 rpm
RETÉN CIGÜEÑAL	REAR MAIN SEAL	PARAOLIO POST. ALBERO MOTORE	JOINT AR DE VILEBREQUIN	1
ROTACIÓN	ROTATION	ROTAZIONE	ROTATION	Standard
CILINDROS	CYLINDER	CILINDRI	CYLINDRES	4 Inline Standard
ORDEN DE ENCENDIDO	FIRING ORDER	ORDINE DI ACCENSIONE	ORDRE D'ALLUMAGE	1-3-4-2
CAPACIDAD CARTER ACEITE	OIL PAN CAPACITY	COPPA L'OLIO CAPACITÀ	CAPACITÉ DU CARTER D'HUILE	4 quarts
TIPO ACEITE	OIL TYPE	TIPO OLIO	TYPE D'HUILE	SAE 15W40
Todos los componentes internos	All internal components	Tutti i componenti interni	Tous les composants internes	
 Harmonic Balancer	Harmonic Balancer	Harmonic Balancer	Balancier d'équilibrage	
Culata	Cylinder Head	Testata	Culasse	
Tapa válvulas	Valve Cover	Coperchio punterie	Cache-culbuteurs	
Tapa distribución	Timing Cover	Coperchio distribuzione	Couvercle de distribution	
Cárter de aceite	Oil Pan	Coppa dell'olio	Carter d'huile	
 Para sustituir a los motores anteriores a 1989, con retén de cigüeñal de 2 piezas y con volante de menos diámetro, debemos sustituir el motor de arranque y el acoplamiento del motor	To replace the engines before 1989 with 2 pieces crankshaft seal and flywheel of less diameter, you must substitute the starter and the drive plate of the engine	Per sostituire i motori precedenti al 1989, con paraolio albero motore in 2 pz, e volante di dimensioni più piccole, bisogna sostituire il motorino d'avviamento e l'accoppiamento del motore.	Pour remplacer les moteurs antérieurs à 1989 dotés de joints de vilebrequin en deux parties et de diamètres de volant plus petits, il faut remplacer le démarreur et l'accouplement du moteur.	
 BOMBA DE AGUA	WATER PUMP	POMPA ACQUA	POMPE À EAU	REC46-8M0113733
JUNTA ESCAPE	EXHAUST GASKET	GUARNIZIONE SCARICO	JOINT D'ÉCHAPPEMENT	REC27-815528
BUJÍAS	SPARK PLUG	CANDELA	BOUGIE	NGKBPR6EFS
JUNTA TERMOSTATO	THERMOSTAT GASKET	GUARNIZIONE TERMOSTATO	JOINT DE THERMOSTAT	REC27-8146801



	Incluido	Included	Incluso	Comprend
	Atención	Attention	Attenzione	Attention
	Recomendado	Recommended	Consigliato	Recommandé



## 4.3L - 4.3GXI & 4.3L MPI VORTEC 4.3 (2008-15)

REF	OEM
RECGM262VORTEC	MERCUISER: 879150A31 VOLVO: 3801555 OMC CRUSADER INDMAR (2008+)



	CUBICAJE	DISPLACEMENT	CILINDRATA	CYLINDRÉE	4.3L (262 CID)
	POTENCIA CIGÜEÑAL	HORSE POWER	POTENZA ALL'ALBERO MOTORE	PUISSANCE AU VILEBREQUIN	223 HP @ 4800 rpm
	TORSIÓN	TORQUE	TORCENTE	COUPLE	267 lb-ft @ 2800 rpm
	RETÉN CIGÜEÑAL	REAR MAIN SEAL	PARAOLIO POST. ALBERO MOTORE	JOINT AR DE VILEBREQUIN	1
	CIGÜEÑAL	CRANK SHAFT	ALBERO MOTORE	VILEBREQUIN	Remanufact.
	TORNILLOS COLECTOR ADMISIÓN	INTAKE MANIFOLD, BOLTS	VITI COLLETTORE ASPIRAZIONE	VIS COLLECTEUR ADMISSION	8
	ROTACIÓN	ROTATION	ROTAZIONE	ROTATION	Standard
	CILINDROS	CYLINDER	CILINDRI	CYLINDRES	90° V6 Standard
	ORDEN DE ENCENDIDO	FIRING ORDER	ORDINE DI ACCENSIONE	ORDRE D'ALLUMAGE	1-6-5-4-3-2
	CAPACIDAD CARTER ACEITE	OIL PAN CAPACITY	COPPA L'OLIO CAPACITÀ	CAPACITÉ DU CARTER D'HUILE	4.5 quarts
	TIPO ACEITE	OIL TYPE	TIPO OLIO	TYPE D'HUILE	SAE 15W40
	Nº BLOQUE	BLOCK CASTING NUMBER	NUM. BLOCCO	NUM. BLOC	2600234/324
	Nº CULATA	HEAD CASTING NUMBER	NUM. TESTA	NUM. CULASSE	12557113/12558114
	Todos los componentes internos	All internal components	Tutti i componenti interni	Tous les composants internes	
	Tapa válvulas	Valve Cover	Coperchio punterie	Cache culbuteurs	
	Tapa distribución aluminio	Timing Cover aluminium	Coperchio distribuzione in alluminio	Carter de distribution AL	
	Eje equilibrado	Balance shaft	Asse bilanciato	Arbre d'équilibrage	
	Cárter de aceite	Oil Pan	Coppa dell'olio	Carter d'huile	
	El colector de admisión de este motor está fijado a las culatas con 8 tornillos. Si el motor a substituir tiene 12 tornillos se debe ordenar: MP425036 Colector admisión carburador 4 cuerpos. o MP425024 Colector admisión carburador 2 cuerpos + MP001204 Tornillos colector	The intake manifold in this engine is fixed to the heads with 8 screws. If the engine to substitute have 12 screws, you must order: MP425036 Intake manifold carburetor 4 bbl. or MP425024 Intake manifold carburetor 2 bbl. + MP001204 Bolts for intake manifold	Il collettore d'aspirazione di questo motore va montato con 8 viti. Nel caso il vecchio motore avesse montato il modello con 12 viti, bisognerà ordinare: MP425036 Collet. aspirazione carburatore a 4 corpi. o MP425024 Collet. aspirazione carburatore a 2 corpi + MP001204 Viteria collettore	Le collecteur d'admission de ce moteur est fixé aux culasses par 8 boulons. Si le moteur à remplacer comporte 12 boulons, il faut le commander : MP425036 Collecteur d'admission carburateur 4 corps. o MP425024 Collecteur d'admission carburateur 2 corps + MP001204 Vis de collecteur.	
	<b>NO SUSTITUYE BLOQUES 090, 090M</b>	<b>DOES NOT REPLACE BLOCKS 090, 090M</b>	<b>NON SOSTITUISCE BLOCCHI 090, 090M</b>	<b>NE REMPLACE PAS LES BLOCS 090, 090M</b>	
	BOMBA DE AGUA	WATER PUMP	POMPA ACQUA	POMPE A EAU	REC879194401
	JUNTA ESCAPE	EXHAUST GASKET	GUARNIZIONE SCARICO	JOINT D'ÉCHAPPEMENT	REC27-99757
	JUNTA COLECTOR ADMISIÓN	GASKET: INTAKE MANIFOLD	GUARNIZIONE: COLLETTORE ASPIRAZIONE	KIT JOINTS COLLECTEUR ADMISSION	REC824326002
	BUJÍAS	SPARK PLUG	CANDELA	BOUGIE	NGKBPR6EFS

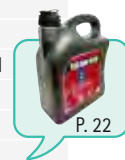

### VORTEC 5.0L (1996+)

REF	OEM
RECGM305VORTEC	MERCUISER VOLVO OMC CRUSADER COBRA



	CUBICAJE	DISPLACEMENT	CILINDRATA	CYLINDRÉE	5.0L (305 CID)
	POTENCIA CIGÜEÑAL	HORSE POWER	POTENZA ALL'ALBERO MOTORE	PUISSANCE AU VILEBREQUIN	250 HP@4800rpm (4bbl carbureted)
	TORSIÓN	TORQUE	TORCENTE	COUPLE	305 lb-ft @3600rpm
	RETÉN CIGÜEÑAL	REAR MAIN SEAL	PARAOLIO POST. ALBERO MOTORE	JOINT AR DE VILEBREQUIN	1
	TORNILLOS COLECTOR ADMISIÓN	INTAKE MANIFOLD, BOLTS	VITI COLLETTORE ASPIRAZIONE	VIS COLLECTEUR ADMISSION	8
	ROTACIÓN	ROTATION	ROTAZIONE	ROTATION	Standard
	CILINDROS	CYLINDER	CILINDRI	CYLINDRES	90° V8 Standard
	RATIO COMPRESIÓN	COMPRESSION RATIO	RAPPORTO DI COMPRESIONE	RAPPORT DE COMPRESSION	9:4:1
	ORDEN DE ENCENDIDO	FIRING ORDER	ORDINE DI ACCENSIONE	ORDRE D'ALLUMAGE	1-8-4-3-6-5-7-2
	CAPACIDAD CARTER ACEITE	OIL PAN CAPACITY	COPPA L'OLIO CAPACITÀ	CAPACITÉ CARTER D'HUILE	5.5 quarts
	TIPO ACEITE	OIL TYPE	TIPO OLIO	TYPE D'HUILE	SAE 15W40
	Todos los componentes internos	All internal components	Tutti i componenti interni	Tous les composants internes	
	Tapa válvulas	Valve Cover	Coperchio punterie	Cache culbuteurs	
	Tapa distribución	Timing Cover	Coperchio distribuzione	Carter de distribution	
	Eje equilibrado	Harmonic balancer	Asse bilanciato	Arbre d'équilibrage	
	BOMBA DE AGUA	WATER PUMP	POMPA ACQUA	POMPE A EAU	REC46-8M0113734
	JUNTA ESCAPE	EXHAUST GASKET	GUARNIZIONE SCARICO	JOINT D'ÉCHAPPEMENT	REC27-33395
	JUNTA ADMISIÓN	INTAKE GASKET	GUARNIZIONE ASPIRAZIONE	JOINT	REC27-807473A1
	BUJÍAS	SPARK PLUG	CANDELA	BOUGIE	NGKBR6EFS
	COLECTOR ADMISIÓN 4 CUERPOS	INTAKE MANIFOLD 4BBL	COLLETTORE ASPIRAZIONE 4 CORPI	COLLECTEUR ADMISSION 4 CORPS	REC425062



P. 22

### 5.7L CARB (1967-85) LONG BLOCK

REF	OEM
RECGM350	MERCUISER VOLVO OMC CRUSADER COBRA



	CUBICAJE	DISPLACEMENT	CILINDRATA	CYLINDRÉE	5.7L (350 CID)
	POTENCIA CIGÜEÑAL	HORSE POWER	POTENZA ALL'ALBERO MOTORE	PUISSANCE AU VILEBREQUIN	260 HP@4400rpm
	TORSIÓN	TORQUE	TORCENTE	COUPLE	350 lb-ft @3600rpm
	RETÉN CIGÜEÑAL	REAR MAIN SEAL	PARAOLIO POST. ALBERO MOTORE	JOINT AR DE VILEBREQUIN	2
	TORNILLOS COLECTOR ADMISIÓN	INTAKE MANIFOLD, BOLTS	VITI COLLETTORE ASPIRAZIONE	VIS COLLECTEUR ADMISSION	12
	ROTACIÓN	ROTATION	ROTAZIONE	ROTATION	STD
	CILINDROS	CYLINDER	CILINDRI	CYLINDRES	90° V8
	ORDEN DE ENCENDIDO	FIRING ORDER	ORDINE DI ACCENSIONE	ORDRE D'ALLUMAGE	1-8-4-3-6-5-7-2
	BOMBA COMBUSTIBLE MECÁNICA	MECHANICAL FUEL PUMP	POMPA COMBUSIBILE MECCANICA	POMPE A CARBURANT MECANIQUE	✓
	ÁRBOL DE LEVAS PLANO	FLAT CAMSHAFT	ALBERO A CAMME PIATTO	ARBRE À CAMES PLAT	
	CAPACIDAD CARTER ACEITE	OIL PAN CAPACITY	COPPA L'OLIO CAPACITÀ	CAPACITÉ CARTER D'HUILE	5.5 quarts
	TIPO ACEITE	OIL TYPE	TIPO OLIO	TYPE D'HUILE	SAE 15W40
	Todos los componentes internos	All internal components	Tutti i componenti interni	Tous les composants internes	
	Tapa válvulas	Valve Cover	Coperchio punterie	Cache culbuteurs	
	Tapa distribución	Timing Cover	Coperchio distribuzione	Carter de distribution	
	Carter de aceite	Oil pan	Coppa dell'olio	Carter d'huile	
	BOMBA DE AGUA	WATER PUMP	POMPA ACQUA	POMPE A EAU	REC46-8M0113734
	JUNTA ESCAPE	EXHAUST GASKET	GUARNIZIONE SCARICO	JOINT D'ÉCHAPPEMENT	REC27-33395
	JUNTA ADMISIÓN	INTAKE GASKET	GUARNIZIONE ASPIRAZIONE	JOINT	REC17320
	BUJÍAS	SPARK PLUG	CANDELA	BOUGIE	NGKBR6FS





P. 22

## 5.7L (1986-95) CARB / TBI

REF	OEM
RECGM350PREVORTEC	MERCUISER: 807447R2, 807447R50 VOLVO OMC CRUSADER VOLVO: 856706, 856901



CUBICAJE	DISPLACEMENT	CILINDRATA	CYLINDRÉE	5.7L (350 CID)
POTENCIA CIGÜEÑAL	HORSE POWER	POTENZA ALL'ALBERO MOTORE	PUISSANCE AU VILEBREQUIN	270 HP@4800rpm
TORSIÓN	TORQUE	TORCENTE	COUPLE	340 lb-ft @3200rpm
RETÉN CIGÜEÑAL	REAR MAIN SEAL	PARAOLIO POST. ALBERO MOTORE	JOINT AR DE VILEBREQUIN	1
TORNILLOS COLECTOR ADMISIÓN	INTAKE MANIFOLD, BOLTS	VITI COLLETTORE ASPIRAZIONE	VIS COLLECTEUR ADMISSION	12
ROTACIÓN	ROTATION	ROTAZIONE	ROTATION	Standard
CILINDROS	CYLINDER	CILINDRI	CYLINDRES	90° V8 standard
RATIO COMPOSICIÓN	COMPOSITION RATIO	RAPPORTO DI COMPOSIZIONE	TAUX DE COMPRESSION	9:1:4
ORDEN DE ENCENDIDO	FIRING ORDER	ORDINE DI ACCENSIONE	ORDRE D'ALLUMAGE	1-8-4-3-6-5-7-2
ÁRBOL DE LEVAS PLANO	FLAT CAMSHAFT	ALBERO A CAMME PIATTO	ARBRE À CAMES PLAT	
CAPACIDAD CARTER ACEITE	OIL PAN CAPACITY	COPPA L'OLIO CAPACITÀ	CAPACITÉ CARTER D'HUILE	5.5 quarts
TIPO ACEITE	OIL TYPE	TIPO OLIO	TYPE D'HUILE	SAE 15W40
 Todos los componentes internos	All internal components	Tutti i componenti interni	Tous les composants internes	
Tapa válvulas	Valve Cover	Coperchio punterie	Cache culbuteurs	
Tapa distribución	Timing Cover	Coperchio distribuzione	Carter de distribution	
Carter de aceite	Oil pan	Coppa dell'olio	Carter d'huile	
 BOMBA DE AGUA	WATER PUMP	POMPA ACQUA	POMPE A EAU	REC46-8M0113734
JUNTA ESCAPE	EXHAUST GASKET	GUARNIZIONE SCARICO	JOINT D'ÉCHAPPEMENT	REC27-33395
JUNTA ADMISIÓN	INTAKE GASKET	GUARNIZIONE ASPIRAZIONE	JOINT	REC17320
BUJÍAS	SPARK PLUG	CANDELA	BOUGIE	NGKBR6FS





P. 22

## 5.7L VORTEC (1996+) CARB / TBI

REF	OEM
RECGM350VORTEC	MERCUISER: 863661A1, 8M0088397 VOLVO: 3801411, 3801529 OMC CRUSADER



CUBICAJE	DISPLACEMENT	CILINDRATA	CYLINDRÉE	5.7L (350 CID)
POTENCIA CIGÜEÑAL	HORSE POWER	POTENZA ALL'ALBERO MOTORE	PUISSANCE AU VILEBREQUIN	330 HP@4800rpm
TORSIÓN	TORQUE	TORCENTE	COUPLE	355 lb-ft @3600rpm (4 BBL carb.)
RETÉN CIGÜEÑAL	REAR MAIN SEAL	PARAOLIO POST. ALBERO MOTORE	JOINT AR DE VILEBREQUIN	1
TORNILLOS COLECTOR ADMISIÓN	INTAKE MANIFOLD, BOLTS	VITI COLLETTORE ASPIRAZIONE	VIS COLLECTEUR ADMISSION	8
ROTACIÓN	ROTATION	ROTAZIONE	ROTATION	Standard
CILINDROS	CYLINDER	CILINDRI	CYLINDRES	90° V8 Standard
RATIO COMPOSICIÓN	COMPOSITION RATIO	RAPPORTO DI COMPOSIZIONE	TAUX DE COMPRESSION	9:1:4
ORDEN DE ENCENDIDO	FIRING ORDER	ORDINE DI ACCENSIONE	ORDRE D'ALLUMAGE	1-8-4-3-6-5-7-2
BOMBA COMBUSTIBLE ELÉCTRICA	ELECTRIC FUEL PUMP	POMPA COMBUSIBILE ELETRICA	POMPE A CARBURANT ELECTRIQUE	✓
SENSOR DE CIGÜEÑAL	CRANK SHAFT SENDER	SENSORE ALBERO MOTORE	SONDE DE VILEBREQUIN	✓
ÁRBOL DE LEVAS DE RODILLOS HIDRÁULICOS	HYDRAULIC ROLLER CAMSHAFT	ALBERO A CAMME DEL RULLO IDRAULICO	ARBRE À CAMES À ROULEAUX HYDRAULIQUES	
CAPACIDAD CARTER ACEITE	OIL PAN CAPACITY	COPPA L'OLIO CAPACITÀ	CAPACITÉ CARTER D'HUILE	5.5 quarts
TIPO ACEITE	OIL TYPE	TIPO OLIO	TYPE D'HUILE	SAE 15W40
 Todos los componentes internos	All internal components	Tutti i componenti interni	Tous les composants internes	
Tapa válvulas	Valve Cover	Coperchio punterie	Cache culbuteurs	
Tapa distribución de composite	Composite timing Cover	Coperchio distribuzione composite	Carter de distribution composite	
Carter de aceite	Oil pan	Coppa dell'olio	Carter d'huile	
 Para motores MPI pedir la ref. REC15254	For engine MPI order ref. REC15254	Per motori MPI aggiungere la ref. REC15254	Pour moteurs MPI il faut la ref REC15254. Couvreur distributeur avec senseur.	
Tapa distribución con sensor	Timing cover with sensor	Coperchio distribuzione con sensore		
 BOMBA DE AGUA	WATER PUMP	POMPA ACQUA	POMPE A EAU	REC46-8M0113734
JUNTA ESCAPE	EXHAUST GASKET	GUARNIZIONE SCARICO	JOINT D'ÉCHAPPEMENT	REC27-33395
JUNTA ADMISIÓN	INTAKE GASKET	GUARNIZIONE ASPIRAZIONE	JOINT	REC27-807473A1
BUJÍAS	SPARK PLUG	CANDELA	BOUGIE	NGKBR6EFS



P. 22

### 5.7L MPI (1996+)

REF	OEM
RECGM350MPI	MERCUISER: 800-866138A03 VOLVO: 3862058 OMC CRUSADER



	CUBICAJE	DISPLACEMENT	CILINDRATA	CYLINDRÉE	
	POTENCIA CIGÜEÑAL	HORSE POWER	POTENZA ALL'ALBERO MOTORE	PUISSANCE AU VILEBREQUIN	5.7L (350 CID) 350 HP@4500rpm (4 BBL carb.) 425 lb-ft @3600rpm
	TORSIÓN	TORQUE	TORCENTE	COUPLE	1
	RETÉN CIGÜEÑAL	REAR MAIN SEAL	PARAOLIO POST. ALBERO MOTORE	JOINT AR DE VILEBREQUIN	1
	TORNILLOS COLECTOR ADMISIÓN	INTAKE MANIFOLD, BOLTS	VITI COLLETTORE ASPIRAZIONE	VIS COLLECTEUR ADMISSION	4
	ROTACIÓN	ROTATION	ROTAZIONE	ROTATION	Standard
	CILINDROS	CYLINDER	CILINDRI	CYLINDRES	90° V8 Standard
	RATIO COMPOSICIÓN	COMPOSITION RATIO	RAPPORTO DI COMPOSIZIONE	TAUX DE COMPRESSION	9:4:1
	ORDEN DE ENCENDIDO	FIRING ORDER	ORDINE DI ACCENSIONE	ORDRE D'ALLUMAGE	1-8-4-3-6-5-7-2
	BOMBA COMBUSTIBLE ELECTRICA	ELECTRIC FUEL PUMP	POMPA COMBUSIBILE ELETTRICA	POMPE A CARBURANT ELECTRIQUE	✓
	SENSOR DE CIGÜEÑAL	CRANK SHAFT SENDER	SENSORE ALBERO MOTORE	SONDE DE VILEBREQUIN	✓
	COLECTOR ADMISIÓN 8	8 BOLT STYLE INTAKE MANIFOLD	COLLETTORE ASPIRAZIONE 8 BULLONI	COLLECTEUR ADMISSION 8 VIS	MultiPort injection
	CAPACIDAD CARTER ACEITE	OIL PAN CAPACITY	COPPA L'OLIO CAPACITÀ	CAPACITÉ CARTER D'HUILE	5.5 quarts
	TIPO ACEITE	OIL TYPE	TIPO OLIO	TYPE D'HUILE	SAE 15W40
	Todos los componentes internos	All internal components	Tutti i componenti interni	Tous les composants internes	
	Tapa válvulas	Valve Cover	Coperchio punterie	Cache culbuteurs	
	Tapa distribución de composite	Composite timing Cover	Coperchio distribuzione composite	Carter de distribution composite	
	Carter de aceite	Oil pan	Coppa dell'olio	Carter d'huile	
	Requiere sensor de cigüeñal	Crank position required	Richiede l'uso sensore di posizione dell'albero motore	Capteur de vilebrequin requis	
	BOMBA DE AGUA	WATER PUMP	POMPA ACQUA	POMPE A EAU	REC46-8M0113734
	JUNTA ESCAPE	EXHAUST GASKET	GUARNIZIONE SCARICO	JOINT D'ECHAPPEMENT	REC27-33395
	JUNTA ADMISIÓN	INTAKE GASKET	GUARNIZIONE ASPIRAZIONE	JOINT	REC27-807473A1
	BUJÍAS	SPARK PLUG	CANDELA	BOUGIE	NGKBPR6EFS



P. 22

### 6.2L (1996+)

REF	OEM
RECGM6.2MPI	MERCUISER: 865108A02



	CUBICAJE	DISPLACEMENT	CILINDRATA	CYLINDRÉE	
	POTENCIA CIGÜEÑAL	HORSE POWER	POTENZA ALL'ALBERO MOTORE	PUISSANCE AU VILEBREQUIN	6.2L MAG (377 CID) 355 HP@4500rpm (4 BBL carb.) 425 lb-ft @3600rpm
	TORSIÓN	TORQUE	TORCENTE	COUPLE	1
	RETÉN CIGÜEÑAL	REAR MAIN SEAL	PARAOLIO POST. ALBERO MOTORE	JOINT AR DE VILEBREQUIN	1
	TORNILLOS COLECTOR ADMISIÓN	INTAKE MANIFOLD, BOLTS	VITI COLLETTORE ASPIRAZIONE	VIS COLLECTEUR ADMISSION	8
	ROTACIÓN	ROTATION	ROTAZIONE	ROTATION	Standard
	CILINDROS	CYLINDER	CILINDRI	CYLINDRES	90° V8 Standard
	RATIO COMPOSICIÓN	COMPOSITION RATIO	RAPPORTO DI COMPOSIZIONE	TAUX DE COMPRESSION	9:4:1
	ORDEN DE ENCENDIDO	FIRING ORDER	ORDINE DI ACCENSIONE	ORDRE D'ALLUMAGE	1-8-4-3-6-5-7-2
	LIFTERS HIDRÁULICOS	HYDRAULIC LIFTER	SOLLEVATORE IDRAULICO	LIFTER HYDRAULIQUE	✓
	SENSOR DE CIGÜEÑAL	CRANK SHAFT SENDER	SENSORE ALBERO MOTORE	SONDE DE VILEBREQUIN	✓
	COLECTOR ADMISIÓN 8	8 BOLT STYLE INTAKE MANIFOLD	COLLETTORE ASPIRAZIONE 8 BULLONI	COLLECTEUR ADMISSION 8 VIS	MultiPort injection
	CAPACIDAD CARTER ACEITE	OIL PAN CAPACITY	COPPA L'OLIO CAPACITÀ	CAPACITÉ CARTER D'HUILE	5.5 quarts
	TIPO ACEITE	OIL TYPE	TIPO OLIO	TYPE D'HUILE	SAE 15W40
	Todos los componentes internos	All internal components	Tutti i componenti interni	Tous les composants internes	
	Tapa válvulas	Valve Cover	Coperchio punterie	Cache culbuteurs	
	Tapa distribución de composite	Composite timing Cover	Coperchio distribuzione composite	Carter de distribution composite	
	Carter de aceite	Oil pan	Coppa dell'olio	Carter d'huile	
	Requiere sensor de cigüeñal	Crank position required	Richiede l'uso sensore di posizione dell'albero motore	Capteur de vilebrequin requis	
	BOMBA DE AGUA	WATER PUMP	POMPA ACQUA	POMPE A EAU	REC46-8M0113734
	JUNTA ESCAPE	EXHAUST GASKET	GUARNIZIONE SCARICO	JOINT D'ECHAPPEMENT	REC27-33395
	JUNTA ADMISIÓN	INTAKE GASKET	GUARNIZIONE ASPIRAZIONE	JOINT	REC27-807473A1
	BUJÍAS	SPARK PLUG	CANDELA	BOUGIE	NGKBPR6EFS

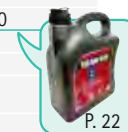

P. 22



**7.4L (1991+)  
CARB / MPI BIG BLOCK**

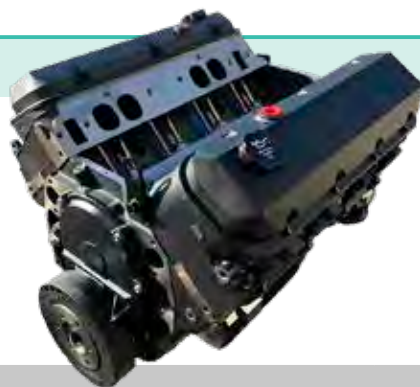

REF
RECGM454

CUBICAJE	DISPLACEMENT	CILINDRATA	CYLINDRÉE	7.4L (454 CID)
POTENCIA CIGÜEÑAL	HORSE POWER	POTENZA ALL'ALBERO MOTORE	PUISSANCE AU VILEBREQUIN	310 HP@5000rpm
TORSIÓN	TORQUE	TORCENTE	COUPLE	404 lb-ft @3800rpm MPI
RETÉN CIGÜEÑAL	REAR MAIN SEAL	PARAOLIO POST. ALBERO MOTORE	JOINT AR DE VILEBREQUIN	1
TORNILLOS COLECTOR ADMISIÓN	INTAKE MANIFOLD, BOLTS	VITI COLLETTORE ASPIRAZIONE	VIS COLLECTEUR ADMISSION	16
ROTACIÓN	ROTATION	ROTAZIONE	ROTATION	STD
CILINDROS	CYLINDER	CILINDRI	CYLINDRES	90° V8
RATIO COMPOSICIÓN	COMPOSITION RATIO	RAPPORTO DI COMPOSIZIONE	TAUX DE COMPRESSION	9.6:1
ORDEN DE ENCENDIDO	FIRING ORDER	ORDINE DI ACCENSIONE	ORDRE D'ALLUMAGE	1-8-4-3-6-5-7-2
ÁRBOL DE LEVAS DE RODILLOS	ROLLER CAMSHAFT	ALBERO A CAMME DEL RULLO	ARBRE À CAMES À ROULEAUX	✓
CABEZAS DE PUERTO OVALADO	OVAL PORT HEADS	TESTE CON ATTACCO OVALE	TÊTES À PORT OVALE	✓ L29
CAPACIDAD CARTER ACEITE	OIL PAN CAPACITY	COPPA L'OLIO CAPACITÀ	CAPACITÉ CARTER D'HUILE	8 quarts
TIPO ACEITE	OIL TYPE	TIPO OLIO	TYPE D'HUILE	SAE15W40
Todos los componentes internos	All internal components	Tutti i componenti interni	Tous les composants internes	
Tapa válvulas	Valve Cover	Coperchio punterie	Cache culbuteurs	
Tapa distribución frontal	Front timing cover	Coperchio distribuzione frontale	Carter de distribution	
Eje equilibrado	Balance shaft	Asse bilanciato	Arbre d'équilibrage	
Carter de aceite	Oil pan	Coppa dell'olio	Carter d'huile	
Con carburación se necesita un estrangulador eléctrico.	Carburetor applications need an electric choke	Con la carburazione, è necessario uno starter elettrico.	Avec un carburateur, un starter électrique est nécessaire.	
BOMBA DE AGUA	WATER PUMP	POMPA ACQUA	POMPE A EAU	REC46-8M0113735
JUNTA ESCAPE	EXHAUST GASKET	GUARNIZIONE SCARICO	JOINT D'ÉCHAPPEMENT	REC27-46820
JUNTA ADMISIÓN	INTAKE GASKET	GUARNIZIONE ASPIRAZIONE	JOINT	REC17340
BUJÍAS	SPARK PLUG	CANDELA	BOUGIE	NGKBPR6EFS



**CULATAS  
GM NUEVOS**

**GM BASE NEW  
CYLINDER HEADS**

**TESTATA  
GM NUOVO**

**CULASSES  
GM NEUVES**

**3.0 L (1991+)  
CASTING #1408620 & #93441744**

REF	
REC936-810849	REC17000



Válvulas & muelles	Valves & spring	Valvole e molle	soupapes et ressorts	✓
--------------------	-----------------	-----------------	----------------------	---

**4.3L (1996+)  
4.3L V6 CHEVY VORTEC**

REF	
REC3861911	REC17010



ESTILO ATORNILLADO	BOLT DOWN STYLE	STILE BULLONE	STYLE BOULONNÉ	10 mm
TORNILLOS ADMISIÓN	BOLT INTAKE	VITI ASPIRAZIONE	VIS ADMISSION	8

Válvulas & muelles	Valves & spring	Valvole e molle	soupapes et ressort	✓
--------------------	-----------------	-----------------	---------------------	---

**5.7L (1969-86)  
V8 CHEVY PREVORTEC**

REF	
REC938-7499	REC17030



ESTILO ATORNILLADO	BOLT DOWN STYLE	STILE BULLONE	STYLE BOULONNÉ	10 mm
TORNILLOS ADMISIÓN	BOLT INTAKE	VITI ASPIRAZIONE	VIS ADMISSION	12
TAPA DE VÁLVULAS CON TORNILLOS DE PERÍMETROS	PERIMETER BOLT VALVE COVERS	COPERCHIO DELLA VALVOLA CON VITI PERIMETRALI	CACHE,CULBUTEUR AVEC VIS PÉRIMÈTRE	✓
 Válvulas & muelles	Valves & spring	Valvole e molle	soupapes et ressorts	✓

**5.0L (1996+)  
V8 305 CHEVY VORTEC**

REF	
REC938-8M0087884	REC17020



TORNILLOS ADMISIÓN	BOLT INTAKE	VITI ASPIRAZIONE	VIS	8
 Válvulas & muelles	Valves & spring	Valvole e molle	soupapes et ressorts	✓

**5.7L & 6.2L (1996+) V8  
5.7L 350CI CHEVY VORTEC**

REF	
REC938-803860T	REC17030



TORNILLOS ADMISIÓN	BOLT INTAKE	VITI ASPIRAZIONE	VIS	8
 Válvulas & muelles	Valves & spring	Valvole e molle	soupapes et ressorts	✓

# GM & FORD

## BLOQUES Y CULATAS REMANUFACTURADOS

Si necesita un motor que no esté en nuestra lista, por favor llámenos. Los números de fundición en bloque y culatas nos ayudarán a suministrarles exactamente sus necesidades.

### Características:

- 12 meses Garantía limitada
- Pistones y aros nuevos
- Levas y lifters marinos
- Tapones de expansión de latón
- Cojinetes nuevos cigüeñal, biela y levas
- Cadena y piñones distribución nuevas
- Bomba de aceite nueva
- Juego de juntas marinas nuevo
- Bloque rectificado y calibrado
- Cigüeñal reacondicionado
- Bielas reacondicionadas
- Culatas rectificadas
- Muelles de válvulas nuevos
- Prueba de giro
- Prueba de presión

## REMANUFACTURED LONG BLOCKS & CYLINDER HEADS

If you need an engine that is not listed in our catalog, please call us. Cylinder head, and block casting numbers will assist us in supplying your exact needs.

### Engine Features:

- 12-month limited warranty
- New pistons, moly rings
- Marine cam and lifters
- Brass block plugs
- New rod, main and cam bearings
- New h.D. Timing chain and gears
- New oil pump
- New marine gasket set
- Block resurfaced, bored and honed
- Crankshaft reconditioned
- Connecting rods reconditioned
- Heads resurfaced
- New valve springs
- Spin tested
- Pressure tested

## BLOCCHI E TESTATE RIGENERATI

Se necessita un motore che non si trova nella lista, non dubiti nel contattarci, i numeri di fusione del blocco e delle testate ci aiuteranno a identificare il modello corretto.

### Caratteristiche:

- 12 mesi Garanzia limitata
- Pistoni e fasce nuove
- Bilancieri e Lifters Marini
- Tappi di dilatazione in bronzo
- Cuscinetti nuovi albero motore
- Catena e pignoni distribuzione nuovi
- Pompa dell'olio nuova
- Kit guarnizioni motore nuove
- Blocco rettificato e calibrato
- Albero motore rigenerato
- Bielle rigenerate
- Testate rigenerate
- Molle valvole nuove
- Testato e fatto girare a motore spento
- Testato e messo in pressione

## BLOCS MOTEURS ET CULASSES REMANUFACTURÉS

Si vous avez besoin d'un moteur qui ne figure pas sur notre liste, veuillez nous appeler. Les numéros coulés du bloc et de la culasse nous aideront à l'identifier et à vous fournir exactement ce dont vous avez besoin.

### Caractéristiques :

- Garantie limitée de 12 mois
- Nouveaux pistons et segments
- Cames et poussoirs marins
- Bouchons d'expansion en laiton
- Nouveaux coussinets de vilebrequin, de bielle et de came.
- Chaîne distribution et pignons neufs
- Nouvelle pompe à huile
- Nouveau jeu de joints marins
- Bloc mis à la terre et calibré
- Vilebrequin reconditionné
- Bielles reconditionnées
- Culasses remanufacturées
- Nouveaux ressorts de soupape
- Essai de rotation
- Test de pression

## IDENTIFICANDO TIPO DE MOTOR BASE GM

□ Entradas Admisión  
Intake Ports  
Entrata aspirazione  
Entrées d'admission

○ 12 Tornillos Colector  
12 Bolt Intake Manifold  
12 Viti collettore aspirazione  
12 Vis collecteur admission

○ Tornillos en perímetro  
Perimeter Bolt  
Viti nel perimetro  
Vis périphérique

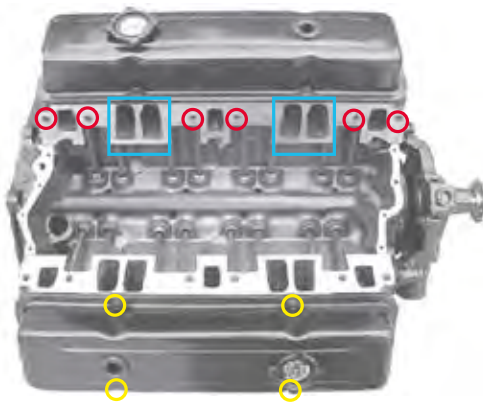

## IDENTIF. MODELLO MOTORE BASE GM

□ Entradas Admisión  
Intake Ports  
Entrata aspirazione  
Entrées d'admission

○ 8 Tornillos Colector  
8 Bolt Intake Manifold  
8 Viti collettore aspirazione  
8 Vis collecteur admission

○ Tornillos Tapa Válvulas en Centro  
Center Bolt Valve Cover  
Viti coperchio punterie centrali  
Vis cache culbuteur au centre

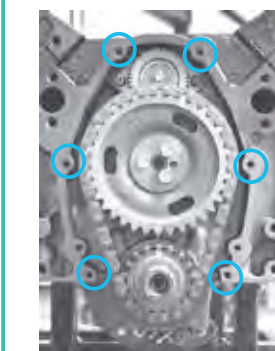
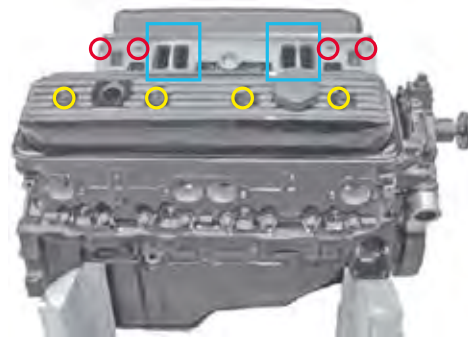

○ Tapa Distribución: 6 tornillos  
6 Bolt Timing Cover  
Carter distribuzione: 6 viti  
CARTER DE DISTRIBUTION : 6 vis

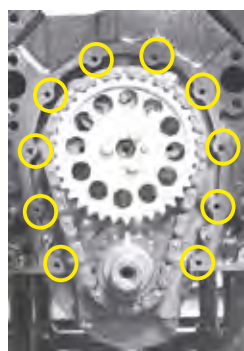

○ Tapa Distribución: 10 tornillos  
10 Bolt Timing Cover  
Carter distribuzione: 10 viti  
CARTER DE DISTRIBUTION : 10 vis

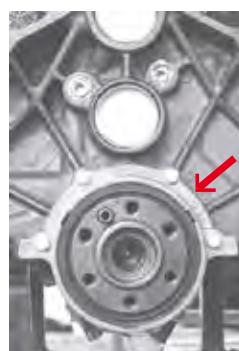

Retén trasero: 1 pieza  
1 Piece. Rear Seal  
Paraolio posterior: 1 pz  
Joint arrière : 1 p.



Retén trasero: 2 piezas  
2 Pieces. Rear Seal  
Paraolio posterior: 2 pz  
Joint arrière : 2 p.

**IDENTIFICANDO BLOQUE Y CULATA**

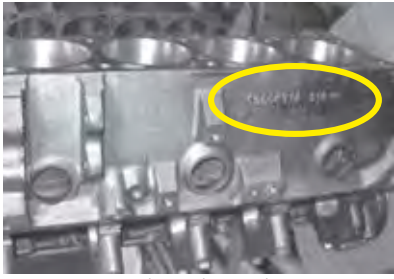

Bloque | Block | Blocco | Bloc  
FORD

**IDENTIFYING BLOCK & HEAD NUMBERS**



Culata | Heads | Testata | Culasse

**IDENTIFICAZIONE BLOCCO E TESTATA**

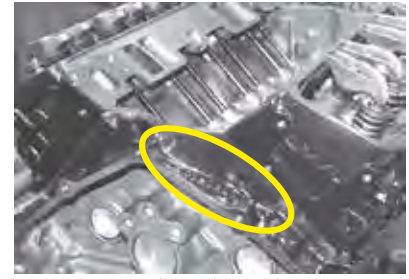

Bloque | Block | Blocco | Bloc  
GM

**MOTORES REMANUFACTURADOS FORD**

**REBUILT ENGINES FORD BLOCKS**

**MOTORI RIGENERATI BASE FORD**

**MOTEURS REMANUFACTURÉS FORD**

351 5.8L - V8							
CULATA	CYLINDER HEAD	TESTATA	CULASSE			FIRH6064	
NÚM. BLOQUE	BLOCK CASTING NUM.	NUM. BLOCCO	NUM. BLOC	D4AE-AA D4AE-DA D9AE-ED D80E D70E-DA		E3AE-BA E4AE	
NUM. CULATA	NUM. CYLINDER HEAD	NUM. TESTATA	NUM. CULASSE			E5AE-CA D80E	E5TE, E7TE
VARILLA ACEITE	OIL DIPSTICK	ASTICELLA DELL'OLIO	JAUGE D'HUILE			Carter, tapa delantera Pan oil, front cover Coppa olio, coperchio front Carter, couvercle avant	
BUJÍA	SPARK PLUG	CANDELA	BOUGIE			Ø 14 mm	
POTENCIA ESTIMADA	HORSE POWER	POTENZA APPROX.	PUISSANCE APROX.			235 - 250 HP	
LIFTERS PLANOS	FLAT TAPPETS	LIFTER PIANI	LIFTERS PLANS			✓	
460 7.5L - V8							
CULATA	CYLINDER HEAD	TESTATA	CULASSE			FIRH6065	
NÚM. BLOQUE	BLOCK CASTING NUM.	NUM. BLOCCO	NUM. BLOC			D9TE	
NUM. CULATA	NUM. CYLINDER HEAD	NUM. TESTATA	NUM. CULASSE			D3VE-A2A D6TE-DA	
NÚM. CIGÜEÑAL	CRANK SHAFT NUM.	NUM. ALBERO MOTORE	NUM. VILEBREQUIN			3Y 3YAABC	
RETENES TRASEROS	REAR GASKETS	PARAOLIO POSTERIORE	JOINTS ARRIÈRES			2	
TORNILLOS BAJO LOS BALANCINES	SCREWS UNDER THE ROCKER ARMS	VITI SOTTO I BALANCIERI	VIS SOUS LES CULBUTEURS				
BUJÍA	SPARK PLUG	CANDELA	BOUGIE			Ø 14 mm	
POTENCIA ESTIMADA	HORSE POWER	POTENZA APPROX.	PUISSANCE APROX.			300 - 340 HP	
LIFTERS PLANOS	FLAT TAPPETS	LIFTER PIANI	LIFTERS PLANS			✓	

**NOTA**

La letra "T" en la referencia de los bloques de motor significa que llevan instalado: tapa de distribución, carter, bomba de aceite y tubo de aspiración.

\* = últimos dígitos

**NOTE**

The letter "T" in the reference of the engine blocks means that includes: Timing cover, oil pan, oil pump and pickup tube installed.

\* = last digits

**NOTA**

La lettera "T" in riferimento ai blocchi motore significa che hanno installato: coperchio distribuzione, carter, pompa olio e tubo di aspirazione.

\* = ultimi numeri

**NOTE**

La lettre "T" dans la référence des blocs moteurs signifie qu'ils ont installé : couvercle de distribution, carter, pompe à huile et tuyau d'aspiration.

\* = derniers numéros



MOTORES REMANUFACTURADOS GM		REBUILT ENGINES GM BLOCKS		MOTORI RIGENERATI BASE GM		MOTEURS REMANUFACTURÉS GM	
<b>262 4.3L - V6</b>							
1985-86	ROTACIÓN ESTÁNDAR	STANDARD ROTATION	ROTAZIONE STANDARD	ROTATION STANDARD	FIRGM262LA		
	CULATA	CYLINDER HEAD	TESTATA	CULASSE	FIRH6009		
	NÚM. BLOQUE	BLOCK CASTING NUM.	NUM. BLOCCO	NUM. BLOC	14071177		
	NUM. CULATA	NUM. CYLINDER HEAD	NUM. TESTATA	NUM. CULASSE	17079268 *107,*476		
	RETENES TRASEROS	REAR GASKETS	PARAOLIO POSTERIORE	JOINTS ARRIÈRES	2		
	TORNILLOS TAPA DE VÁLVULAS	SCREWS VALVE COVER	VITI DE COPERCHIO PUNTERIE	VIS DU CACHE CULBUTEUR	centro   center   centro   centre		
	POTENCIA ESTIMADA	HORSE POWER	POTENZA APPROX.	PUISSANCE APROX.	175 - 205 hp		
1986-88	CULATA	CYLINDER HEAD	TESTATA	CULASSE	FIRH6009		
	NÚM. BLOQUE	BLOCK CASTING NUM.	NUM. BLOCCO	NUM. BLOC	14088553 *683		
	NUM. CULATA	NUM. CYLINDER HEAD	NUM. TESTATA	NUM. CULASSE	14079268, 14131996, 14094768 *107,*476,*103,*066		
	RETENES TRASEROS	REAR GASKETS	PARAOLIO POSTERIORE	JOINTS ARRIÈRES	2		
	TORNILLOS TAPA DE VÁLVULAS	SCREWS VALVE COVER	VITI DE COPERCHIO PUNTERIE	VIS DU CACHE CULBUTEUR	centro   center   centro   centre		
	POTENCIA ESTIMADA	HORSE POWER	POTENZA APPROX.	PUISSANCE APROX.	175 - 205 HP		
	1987-92	CULATA	CYLINDER HEAD	TESTATA	CULASSE	FIRH6009	
NÚM. BLOQUE		BLOCK CASTING NUM.	NUM. BLOCCO	NUM. BLOC	14093611, 10105867, 10066011 *756,*256,*073,*683,*061 14131996, 14094768 *107,*476,*103,*066		
NUM. CULATA		NUM. CYLINDER HEAD	NUM. TESTATA	NUM. CULASSE	1		
RETENES TRASEROS		REAR GASKETS	PARAOLIO POSTERIORE	JOINTS ARRIÈRES	1		
TORNILLOS TAPA DE VÁLVULAS		SCREWS VALVE COVER	VITI DE COPERCHIO PUNTERIE	VIS DU CACHE CULBUTEUR	centro   center   centro   centre		
POTENCIA ESTIMADA		HORSE POWER	POTENZA APPROX.	PUISSANCE APROX.	175 - 205 HP		
LIFTERS DE RODILLOS		ROLLER CAM	SOLLEVATORE RULLI	POUSSOIR À ROULEAUS	✓		
TORNILLOS EN TAPA DISTRIBUCIÓN		BOLT TIMING COVER	VITI CARTER DISTRIBUZIONE	VIS DU CARTER DE DISTRIBUTION	10		
TORNILLOS COLECTOR ADMISIÓN	INTAKE BOLTS	VITI COLLETTORE ASPIRAZIONE	VIS DU COLLECTEUR D'ADMISSION	12			
1992-96	CULATA	CYLINDER HEAD	TESTATA	CULASSE	FIRH6011		
	NÚM. BLOQUE	BLOCK CASTING NUM.	NUM. BLOCCO	NUM. BLOC	*061,*073,*756		
	NUM. CULATA	NUM. CYLINDER HEAD	NUM. TESTATA	NUM. CULASSE	*064,*181,*209,*626		
	TORNILLOS TAPA DE VÁLVULAS	SCREWS VALVE COVER	VITI DE COPERCHIO PUNTERIE	VIS DU CACHE CULBUTEUR	centro   center   centro   centre		
	POTENCIA ESTIMADA	HORSE POWER	POTENZA APPROX.	PUISSANCE APROX.	175 - 205 HP		
	LIFTERS DE RODILLOS	ROLLER CAM	SOLLEVATORE RULLI	POUSSOIR À ROULEAUS	SIN eje calibrado   WITHOUT balance shaft SENZA asse equilibrato   SANS arbre d'équilibrage eléctrica   electric   elettrica   électrique		
	BOMBA COMBUSTIBLE	FUEL PUMP	POMPA BENZINA	POMPE A ESSENCE	12		
TORNILLOS COLECTOR ADMISIÓN	INTAKE BOLTS	VITI COLLETTORE ASPIRAZIONE	VIS DU COLLECTEUR D'ADMISSION	12			
1992-99	ROTACIÓN ESTÁNDAR	STANDARD ROTATION	ROTAZIONE STANDARD	ROTATION STANDARD	FIRGM262LIT		
	CULATA	CYLINDER HEAD	TESTATA	CULASSE	FIRH6011		
	NÚM. BLOQUE	BLOCK CASTING NUM.	NUM. BLOCCO	NUM. BLOC	*196,*359,*534,*535		
	NUM. CULATA	NUM. CYLINDER HEAD	NUM. TESTATA	NUM. CULASSE	*181,*209,*064		
	LIFTERS DE RODILLOS	ROLLER CAM	SOLLEVATORE RULLI	POUSSOIR À ROULEAUS	CON eje calibrado   WITH balance shaft CON asse equilibrato   AVEC arbre d'équilibrage		
	TORNILLOS COLECTOR ADMISIÓN	INTAKE MANIFORD BOLTS	VITI NEL COLLETTORE ASPIRAZIONE	VIS DU COLLECTEUR D'ADMISSION	12		
	TORNILLOS EN TAPA DISTRIBUCIÓN	BOLT TIMING COVER	VITI CARTER DISTRIBUZIONE	VIS DU CARTER DE DISTRIBUTION	6/10		
TORNILLOS EN CARTER	OIL PAN BOLTS	VITI NELLA COPPA DELL'OLIO	VIS EN CARTER	14			
1996-99 VORTEC	ROTACIÓN ESTÁNDAR	STANDARD ROTATION	ROTAZIONE STANDARD	ROTATION STANDARD	FIRGM262LGT		
	CULATA	CYLINDER HEAD	TESTATA	CULASSE	FIRH6010		
	NÚM. BLOQUE	BLOCK CASTING NUM.	NUM. BLOCCO	NUM. BLOC	*090		
	NUM. CULATA	NUM. CYLINDER HEAD	NUM. TESTATA	NUM. CULASSE	*772,*140		
	LIFTERS DE RODILLOS DE FUNDICIÓN	ROLLER ROCKER CASTING	SOLLEVATORE RULLI	POUSSOIR À ROULEAUS DE Fe	CON eje calibrado   WITH balance shaft CON asse equilibrato   AVEC arbre d'équilibrage		
	TORNILLOS COLECTOR ADMISIÓN	INTAKE MANIFORD BOLTS	VITI NEL COLLETTORE ASPIRAZIONE	VIS DE COLLECTEUR D'ADMISSION	8		
	TORNILLOS EN TAPA DISTRIBUCIÓN	BOLT TIMING COVER	VITI CARTER DISTRIBUZIONE	VIS DU CARTER DE DISTRIBUTION	6		
TORNILLOS EN CARTER	OIL PAN BOLTS	VITI NELLA COPPA DELL'OLIO	VIS EN CARTER	10			

NOTA  
La letra "T" en la referencia de los bloques de motor significa que llevan instalado: tapa de distribución, carter, bomba de aceite y tubo de aspiración.  
\* = últimos dígitos

NOTE  
The letter "T" in the reference of the engine blocks means that includes: Timing cover, oil pan, oil pump and pickup tube installed.  
\* = last digits

NOTA  
La lettera "T" in riferimento ai blocchi motore significa che hanno installato: coperchio distribuzione, carter, pompa olio e tubo di aspirazione.  
\* = ultimi numeri

NOTE  
La lettre "T" dans la référence des blocs moteurs signifie qu'ils ont installé : couvercle de distribution, carter, pompe à huile et tuyau d'aspiration.  
\* = derniers numéros

1996-08	ROTACIÓN ESTÁNDAR	STANDARD ROTATION	ROTAZIONE STANDARD	ROTATION STANDARD	FIRGM262LJT
	CULATA	CYLINDER HEAD	TESTATA	CULASSE	REC3861911
	NÚM. BLOQUE	BLOCK CASTING NUM.	NUM. BLOCCO	NUM. BLOC	*090M
	NUM. CULATA	NUM. CYLINDER HEAD	NUM. TESTATA	NUM. CULASSE	*113
	LIFTERS DE RODILLOS	ROLLER CAM	SOLLEVATORE RULLI	POUSSOIR À ROULEAUS	CON eje calibrado   WITH balance shaft CON asse equilibrato   AVEC arbre d'équilibrage
	TORNILLOS COLECTOR ADMISIÓN	INTAKE MANIFORD BOLTS	VITI NEL COLLETTORE ASPIRAZIONE	VIS DE COLLECTEUR D'ADMISSION	8
	TORNILLOS EN TAPA DISTRIBUCIÓN	BOLT TIMING COVER	VITI CARTER DISTRIBUZIONE	VIS DU CARTER DE DISTRIBUTION	6
	TORNILLOS EN CARTER	OIL PAN BOLTS	VITI NELLA COPPA DELL'OLIO	VIS EN CARTER	10
1996-08	ROTACIÓN ESTÁNDAR	STANDARD ROTATION	ROTAZIONE STANDARD	ROTATION STANDARD	RECGM262VORTEC
	CULATA	CYLINDER HEAD	TESTATA	CULASSE	REC3861911
	NÚM. BLOQUE	BLOCK CASTING NUM.	NUM. BLOCCO	NUM. BLOC	*234, *324
	NUM. CULATA	NUM. CYLINDER HEAD	NUM. TESTATA	NUM. CULASSE	*113, *114
	LIFTERS DE RODILLOS	ROLLER CAM	SOLLEVATORE RULLI	POUSSOIR À ROULEAUS	CON eje calibrado   WITH balance shaft CON asse equilibrato   AVEC arbre d'équilibrage
	TORNILLOS COLECTOR ADMISIÓN	INTAKE MANIFORD BOLTS	VITI NEL COLLETTORE ASPIRAZIONE	VIS DE COLLECTEUR D'ADMISSION	8
	TORNILLOS EN TAPA DISTRIBUCIÓN	BOLT TIMING COVER	VITI CARTER DISTRIBUZIONE	VIS DU CARTER DE DISTRIBUTION	8
	TORNILLOS EN CARTER	OIL PAN BOLTS	VITI NELLA COPPA DELL'OLIO	VIS EN CARTER	10
<b>305 5.0L - V8</b>					
	CONTRAROTACIÓN	REVERSER ROTATION	CONTROROTANTE	CONTRAROTATION	FIRGM305RB
	NÚM. BLOQUE	BLOCK CASTING NUM.	NUM. BLOCCO	NUM. BLOC	14102058, 14093627, 14088551, *535
	NUM. CULATA	NUM. CYLINDER HEAD	NUM. TESTATA	NUM. CULASSE	14022601, 14022301, 14014416, *434, *741, *450, *513, *416
	TORNILLOS TAPA DE VÁLVULAS	SCREWS VALVE COVER	VITI DE COPERCHIO PUNTERIE	VIS DU CACHE CULBUTEUR	perimetro   around perimeter   perimetro   Perimètre
	LIFTERS PLANOS	FLAT TAPPETS	LIFTER PIANI	LIFTER PLANS	✓
	POTENCIA ESTIMADA	HORSE POWER	POTENZA APPROX.	PUISSANCE APROX.	200 - 230 HP
1987-99	ROTACIÓN ESTÁNDAR	STANDARD ROTATION	ROTAZIONE STANDARD	ROTATION STANDARD	FIRGM305LCT
	CONTRAROTACIÓN	REVERSER ROTATION	CONTROROTANTE	CONTRAROTATION	FIRGM305RC
	NÚM. BLOQUE	BLOCK CASTING NUM.	NUM. BLOCCO	NUM. BLOC	14102058, 14093627, 14088551, *535
	NUM. CULATA	NUM. CYLINDER HEAD	NUM. TESTATA	NUM. CULASSE	*081 Deben cambiarse las dos culatas Must be replaced both Cylinder Heads Essi devono essere modificate le due testate Les deux culasses doivent être remplacées
	RETENES TRASEROS	REAR GASKETS	PARAOLIO POSTERIORE	JOINTS ARRIÈRES	1
	TORNILLOS TAPA DE VÁLVULAS	SCREWS VALVE COVER	VITI DE COPERCHIO PUNTERIE	VIS DU CACHE CULBUTEUR	centro   center   centro   centre
	TORNILLOS COLECTOR ADMISIÓN	INTAKE MANIFORD BOLTS	VITI NEL COLLETTORE ASPIRAZIONE	VIS DE COLLECTEUR D'ADMISSION	12
	TORNILLOS EN TAPA DISTRIBUCIÓN metálica	BOLT METAL TIMING COVER	VITI CARTER DISTRIBUZIONE IN METALLO	VIS DU CARTER DE DISTRIBUTION metalique	10
	ROTACIÓN ESTÁNDAR	STANDARD ROTATION	ROTAZIONE STANDARD	ROTATION STANDARD	RECGM305VORTEC
	NÚM. BLOQUE	BLOCK CASTING NUM.	NUM. BLOCCO	NUM. BLOQUE	*878, *880
NUM. CULATA	NUM. CYLINDER HEAD	NUM. TESTATA	NUM. CULASSE	*620, *059, *520	
RETENES TRASEROS	REAR GASKETS	PARAOLIO POSTERIORE	JOINTS ARRIÈRES	1	
TORNILLOS COLECTOR ADMISIÓN	INTAKE MANIFORD BOLTS	VITI NEL COLLETTORE ASPIRAZIONE	VIS DE COLLECTEUR D'ADMISSION	8	
TORNILLOS EN TAPA DISTRIBUCIÓN PLÁSTICO	BOLT PLASTIC TIMING COVER	VITI CARTER DISTRIBUZIONE IN PLÁSTICA	VIS DU CARTER DE DISTRIBUTION plastique	10	
<b>350 5.7L - V8</b>					
1976-85	ROTACIÓN ESTÁNDAR	STANDARD ROTATION	ROTAZIONE STANDARD	ROTATION STANDARD	RECGM350
	CULATA	CYLINDER HEAD	TESTATA	CULASSE	REC938-7499
	NÚM. BLOQUE	BLOCK CASTING NUM.	NUM. BLOCCO	NUM. BLOC	*245, *379, *010, *014, *678, *388, *618
	NUM. CULATA	NUM. CYLINDER HEAD	NUM. TESTATA	NUM. CULASSE	*993, *624, *882, *487
	RETENES TRASEROS	REAR GASKETS	PARAOLIO POSTERIORE	JOINTS ARRIÈRES	2
	VARILLA ACEITE	OIL DIPSTICK	ASTICELLA DELL'OLIO	JAUGE D'HUILE	Lateral   on-side   lato   lateral
	TORNILLOS TAPA DE VÁLVULAS	SCREWS VALVE COVER	VITI DE COPERCHIO PUNTERIE	VIS DU CACHE CULBUTEUR	perimetro   around perimeter   perimetro   Perimètre
	POTENCIA ESTIMADA	HORSE POWER	POTENZA APPROX.	PUISSANCE APROX.	260 HP

1986-87	ROTACIÓN ESTÁNDAR	STANDARD ROTATION	ROTAZIONE STANDARD	ROTATION STANDARD	RECGM350PREVORTEC
	CONTRAROTACIÓN	REVERSER ROTATION	CONTROROTANTE	CONTRAROTATION	FIRGM350RBF
	CULATA	CYLINDER HEAD	TESTATA	CULASSE	REC938-7499
	NÚM. BLOQUE	BLOCK CASTING NUM.	NUM. BLOCCO	NUM. BLOC	14101148, 14093638, 14088548, 10054727, *526
	NUM. CULATA	NUM. CYLINDER HEAD	NUM. TESTATA	NUM. CULASSE	*993, *624, *882, *487
	RETENES TRASEROS	REAR GASKETS	PARAOLIO POSTERIORE	JOINTS ARRIÈRES	1
	TORNILLOS TAPA DE VÁLVULAS	SCREWS VALVE COVER	VITI DE COPERCHIO PUNTERIE	VIS DU COUVERCLE DE SOUPAPE	perimetro   around perimeter   perimetro   Perimètre
POTENCIA ESTIMADA	HORSE POWER	POTENZA APPROS.	PUISSANCE APROX.	260 HP	
1988-95	ROTACIÓN ESTÁNDAR	STANDARD ROTATION	ROTAZIONE STANDARD	ROTATION STANDARD	RECGM350PREVORTEC
	CULATA	CYLINDER HEAD	TESTATA	CULASSE	FIRH6023
	NÚM. BLOQUE	BLOCK CASTING NUM.	NUM. BLOCCO	NUM. BLOC	14101148, 14093638, 14088548, 10054727, *526
	NUM. CULATA	NUM. CYLINDER HEAD	NUM. TESTATA	NUM. CULASSE	*193, *083, *217
	RETENES TRASEROS	REAR GASKETS	PARAOLIO POSTERIORE	JOINTS ARRIÈRES	1
	TORNILLOS COLECTOR ADMISIÓN	INTAKE MANIFORD BOLTS	VITI NEL COLLETORE ASPIRAZIONE	VIS DE COLLECTEUR D'ADMISSION	12
	TAPA DISTRIBUCIÓN	TIMING COVER	CARTER DISTRIBUZIONE	CARTER DE DISTRIBUTION	metal   metal   metallo   metalique
TORNILLOS TAPA DE VÁLVULAS	SCREWS VALVE COVER	VITI DE COPERCHIO PUNTERIE	VIS DU COUVERCLE DE SOUPAPE	centro   center   centro   centre	
POTENCIA ESTIMADA	HORSE POWER	POTENZA APPROS.	PUISSANCE APROX.	260 hp	
1995-99	ROTACIÓN ESTÁNDAR	STANDARD ROTATION	ROTAZIONE STANDARD	ROTATION STANDARD	RECGM350PREVORTEC
	CULATA	CYLINDER HEAD	TESTATA	CULASSE	FIRH6023 No VORTEC
	NÚM. BLOQUE	BLOCK CASTING NUM.	NUM. BLOCCO	NUM. BLOC	*880
	NUM. CULATA	NUM. CYLINDER HEAD	NUM. TESTATA	NUM. CULASSE	*193, *083, *217
	RETENES TRASEROS	REAR GASKETS	PARAOLIO POSTERIORE	JOINTS ARRIÈRES	1
	TORNILLOS COLECTOR ADMISIÓN	INTAKE MANIFORD BOLTS	VITI NEL COLLETORE ASPIRAZIONE	VIS DE COLLECTEUR D'ADMISSION	12
	TORNILLOS EN TAPA DISTRIBUCIÓN PLÁSTICO	BOLT PLASTIC TIMING COVER	VITI CARTER DISTRIBUZIONE IN PLÁSTICA	VIS DU CARTER DE DISTRIBUTION plastique	6
BOMBA COMBUSTIBLE	FUEL PUMP	POMPA BENZINA	POMPE A ESSENCE	mecánica, eléctrica   mechanical, electric meccanica, elettrica   mecanique, électrique	
POTENCIA ESTIMADA	HORSE POWER	POTENZA APPROS.	PUISSANCE APROX.	260 hp	
1996+	ROTACIÓN ESTÁNDAR	STANDARD ROTATION	ROTAZIONE STANDARD	ROTATION STANDARD	RECGM350VORTEC
	CULATA	CYLINDER HEAD	TESTATA	CULASSE	REC938-803860T VORTEC
	NÚM. BLOQUE	BLOCK CASTING NUM.	NUM. BLOCCO	NUM. BLOC	*880
	NUM. CULATA	NUM. CYLINDER HEAD	NUM. TESTATA	NUM. CULASSE	*906, *062
	RETENES TRASEROS	REAR GASKETS	PARAOLIO POSTERIORE	JOINTS ARRIÈRES	1
	TORNILLOS COLECTOR ADMISIÓN	INTAKE MANIFORD BOLTS	VITI NEL COLLETORE ASPIRAZIONE	VIS DE COLLECTEUR D'ADMISSION	8
	TORNILLOS EN TAPA DISTRIBUCIÓN PLÁSTICO	BOLT PLASTIC TIMING COVER	VITI CARTER DISTRIBUZIONE IN PLÁSTICA	VIS DU CARTER DE DISTRIBUTION plastique	6
BOMBA COMBUSTIBLE	FUEL PUMP	POMPA BENZINA	POMPE A ESSENCE	mecánica, eléctrica   mechanical, electric meccanica, elettrica   mecanique, électrique	
POTENCIA ESTIMADA	HORSE POWER	POTENZA APPROS.	PUISSANCE APROX.	260 hp	
<b>454 7.4L - V8</b>					
	CONTRAROTACIÓN	REVERSER ROTATION	CONTROROTANTE	CONTRE ROTATION	FIRGM454RB
	NÚM. BLOQUE	BLOCK CASTING NUM.	NUM. BLOCCO	NUM. BLOC	10114182 *297, 313
	NUM. CULATA	NUM. CYLINDER HEAD	NUM. TESTATA	NUM. CULASSE	10114156 *932
	TOMA ADMISIÓN	INTAKE PORT HEADS	FORI D'ASPIRAZIONE	ENTRÉES ADMISSION	OVAL
	RETENES TRASEROS	REAR GASKETS	PARAOLIO POSTERIORE	JOINTS ARRIÈRES	1
	LIFTERS PLANOS	FLAT TAPPETS	LIFTER PIANI	LIFTERS PLANS	✓
	TORNILLOS EN TAPA DISTRIBUCIÓN	BOLT TIMING COVER	VITI CARTER DISTRIBUZIONE	VIS DU CARTER DE DISTRIBUTION	10
1996-99 GEN VI	ROTACIÓN ESTÁNDAR	STANDARD ROTATION	ROTAZIONE STANDARD	ROTATION STANDARD	RECGM454
	CULATA	CYLINDER HEAD	TESTATA	CULASSE	FIRH6036
	NÚM. BLOQUE	BLOCK CASTING NUM.	NUM. BLOCCO	NUM. BLOQUE	*297, 313
	NUM. CULATA	NUM. CYLINDER HEAD	NUM. TESTATA	NUM. CULASSE	*279
	RETENES TRASEROS	REAR GASKETS	PARAOLIO POSTERIORE	JOINTS ARRIÈRES	1
	LIFTERS DE RODILLOS	ROLLER CAM	SOLLEVATORE RULLI	POUSSOIR À ROULEAUS	✓
	BOMBA COMBUSTIBLE	FUEL PUMP	POMPA BENZINA	POMPE A ESSENCE	eléctrica   electric   elettrica   électrique
TORNILLOS EN TAPA DISTRIBUCIÓN	BOLT TIMING COVER	VITI CARTER DISTRIBUZIONE	VIS DU CARTER DE DISTRIBUTION	6	
POTENCIA ESTIMADA	HORSE POWER	POTENZA APPROS.	PUISSANCE APROX.	330 hp	

181 CID 3.0L  
250 CID 4.1L

CULATA

CYLINDER HEAD

TESTATA

CULASSE

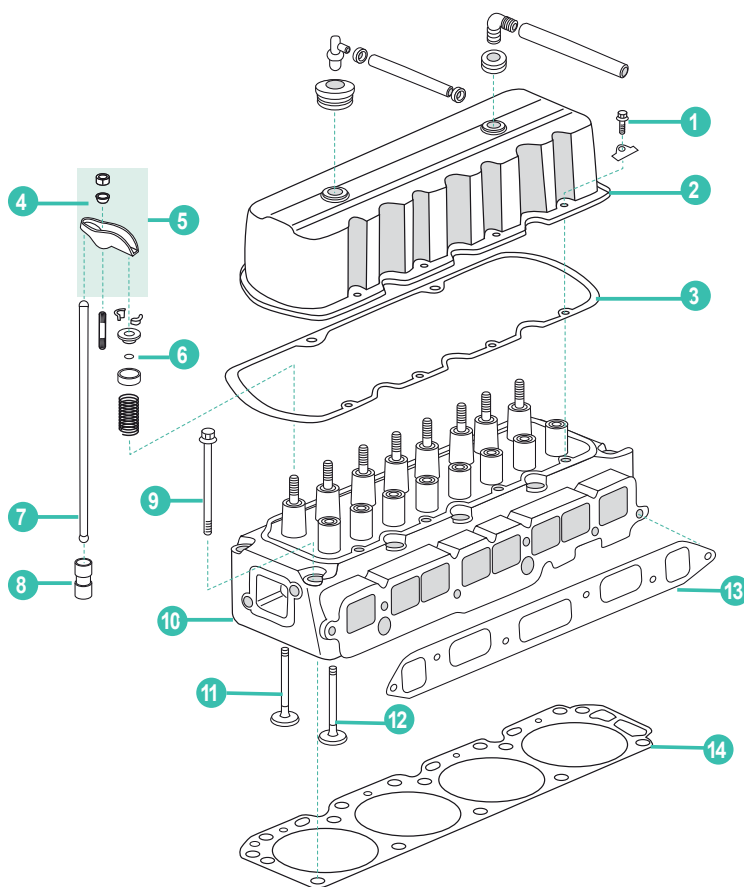

	REF	VOLVO	MERCURUISER					UN.
1	REC912127	3853503	10-65746	TORNILLO, TAPA VÁLVULA	BOLT: VALVE COVER	VITE, COPERCHIO VALVOLA	VIS CACHE CULBUTEUR	5
2	MP0014-100	3853784	851036T	TAPA VÁLVULA: 3.0L	VALVE COVER: 3.0L	COPERCHIO VALVOLA: 3.0L	CACHE CULBUTEUR 3.0L	1
3	REC17900	3852693	27-851040	JUNTA TAPA VÁLVULA 3.0L	GASKET VALVE COVER 3.0L	GUARNIZIONE COPERCHIO VALVOLA 3.0L	JOINT CACHE CULBUTEUR 3.0L	1
	FEL17925		27-49936	JUNTA TAPA VÁLVULA 4.1L	GASKET VALVE COVER 4.1L	GUARNIZIONE COPERCHIO VALVOLA 4.1L	JOINT CACHE CULBUTEUR 4.1L	
4	RM59340		59340	BOLA VÁLVULA BRAZO DEL BALANCÍN	BALL, VALVE ROCKER ARM	SFERA VALVOLA BILANCERE	COUPELLE POUR SOUPEPE ECHAPPEMENT	8
5	REC13514	3853139	34519	BALANCÍN 3.0L	ROCKER ARM 3.0L	BILANCERE 3.0L	CULBUTEUR 3.0L	8
6	REC26-34217	3854956	26-34217	RETÉN VÁLVULA ACEITE	SEAL: VALVE STEM OIL	PARAOILIO VALVOLA OLIO	JOINT D'HUILE DE SOUPEPE	8
7	REC12001	3857899	34532	VARILLA	PUSH ROD	ASTA	TIGE DE CULBUTEUR	8
8	REC14000	3853954	72638	EMPUJADOR VÁLVULA	LIFTER: VALVE	ALZA VALVOLA	POUSSOIR	8
9	REC10501	3857900	10-34510	TORNILLO CULATA	BOLT: CYLINDER HEAD	VITE TESTATA	VIS DE CULASSE	10
10	REC936-810849	3854012	938-8M0115135	CULATA 3.0L (1990+)	CYLINDER HEAD 3.0L (1990+)	TESTATA 3.0L (1990+)	CULASSE 3.0 (1990+)	1
11	REC13503		62421	VÁLVULA ADMISIÓN 2.5L (43.7-8.7-125)	INTAKE VALVE 2.5L (43.7-8.7-125)	VALVOLA ASPIRAZIONE 2.5 (43.7-8.7-125)	SOUPEPE D'ADMISSION 2.5L (43.7-8.7-125)	4
	REC13504	3857879	97661	VÁLVULA ESCAPE 4.1L (43.7-8.7-125)	EXHAUST VALVE 4.1L (43.7-8.7-125)	VALVOLA SCARICO 4.1L (43.7-8.7-125)	SOUPEPE D'ECHAPPEMENT 4.1L (43.7-8.7-125)	
12	REC13501	3853127	52367	VÁLVULA ESCAPE 3.0L (40.7-8.7-125)	EXHAUST VALVE 3.0L (40.7-8.7-125)	VALVOLA SCARICO 3.0L (40.7-8.7-125)	SOUPEPE D'ECHAPPEMENT 3.0L (40.7-8.7-125)	4
	REC13502	856368	85803	VÁLVULA ESCAPE 2.5L (38.1-8.7-125)	EXHAUST VALVE 2.5L (38.1-8.7-125)	VALVOLA SCARICO 2.5L (38.1-8.7-125)	SOUPEPE D'ECHAPPEMENT 2.5L (38.1-8.7-125)	
13	REC27-52546		27-52546	JUNTAS ADMISIÓN / ESCAPE 2.5L	INTAKE / EXHAUST GASKET 2.5L	GUARNIZ. ASPIRAZIONE / SCARICCO 2.5L	JOINTS, ADMSSION / ECHAPPEMENT 2.5L	
	REC27-53354		27-53354	JUNTAS ADMISIÓN / ESCAPE 181	INTAKE / EXHAUST GASKET 181	GUARNIZ. ASPIRAZIONE / SCARICCO 181	JOINTS, ADMSSION / ECHAPPEMENT 181	
	REC27-96429		27-96429	JUNTAS ADMISIÓN / ESCAPE 3.0L (NO LX)	INTAKE / EXHAUST GASKET 3.0L (NOT LX)	GUARNIZ. ASPIRAZIONE / SCARICCO 3.0L (NO LX)	JOINTS, ADMSSION / ECHAPPEMENT 3.0L (NON LX)	1
	REC27-815528	3853256	27-815528	JUNTAS ADMISIÓN / ESCAPE 3.0LX (1991+)	INTAKE / EXHAUST GASKET 3.0LX (1991+)	GUARNIZ. ASPIRAZIONE / SCARICCO 3.0LX (1991+)	JOINTS, ADMSSION / ECHAPPEMENT 3.0LX (1991+)	
	FEL17319		27-46401	JUNTAS ADMISIÓN / ESCAPE 4.1L	INTAKE / EXHAUST GASKET 4.1L	GUARNIZ. ASPIRAZIONE / SCARICCO 4.1L	JOINTS, ADMSSION / ECHAPPEMENT 4.1L	
14	REC17000	3853336	27-52364	JUNTAS CULATA 181 (3.0L)	CYLINDER HEAD GASKE 181 (3.0L)	GUARNIZ. TESTATA 181 (3.0L)	JOINTS DE CULASSE 181 (3.0L)	1
	FEL17019		24-47453	JUNTAS CULATA 4.1L	CYLINDER HEAD GASKE 4.1L	GUARNIZ. TESTATA 4.1L	JOINTS DE CULASSE 4.1L	



CARTER ACEITE	OIL PAN	COPPA OLIO	CARTER D'HUILE
---------------	---------	------------	----------------

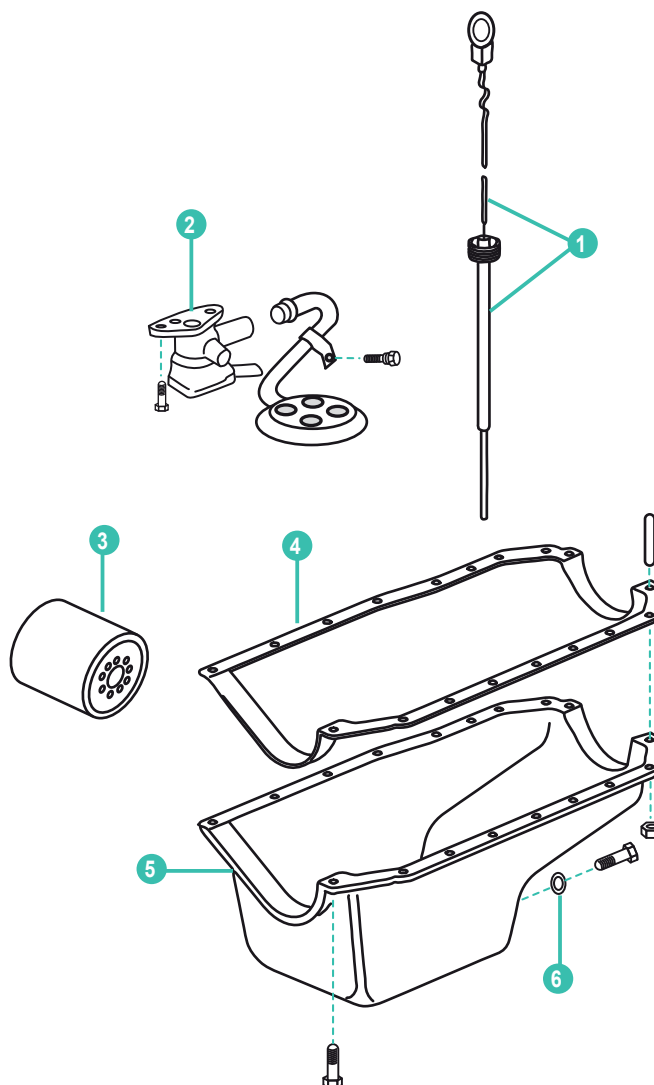

	REF	VOLVO	MERCURUISER					UN.
1	MP0314-002			VARILLA + TUBO ACEITE 181	DIPSTICK + TUBE 181 OIL	ASTA + TUBO OLIO 181	TIGE + TUBE D'HUILE 181	1
2	REC14100	3853843	36405	BOMBA ACEITE:181 RX	PUMP: 181 RX OIL	POMPA OLIO: 181 RX	POMPE A HUILE: 181 RX	1
3				FILTRO ACEITE	FILTER OIL	FILTRO OLIO	FILTRE A HUILE	1
				JUNTA CÁRTER	GASKET OIL PAN	GUARNIZIONE COPPA OLIO	JOINT DE CARTER	
	REC17950	27-52144		4 PIEZAS	4 Pcs.	4 PEZZI	4 PIÈCES	
4	REC17102	3853343	27-810846	3.0L (retén trasero 1 pieza)	3.0L (1 Piece rear seal)	3.0L (tenuta posteriore 1 peze)	3.0L (joint arrière 1 pièce)	1
	FEL17975	27-49949		4.1L	4.1L	4.1L	4.1L	
5	RM810845	3854015	810845T	CÁRTER 181 3.0L Y 3.0 LX, MPI, TKS (1990+)	OIL PAN 181 3.0L Et 3.0 LX, MPI, TKS (1990+)	COPPA OLIO 181 3.0L E 3.0 LX, MPI, TKS (1990+)	CARTER 181 3.0L ET 3.0LX, MPI, TKS (1990+)	1
6	REC27-49955	3851981	27-49955	JUNTA	GASKET	GUARNIZIONE	JOINT	1
				KIT JUNTAS	GASKET SET	KIT GAURNIZIONE	KIT JOINTS	
	REC17100	32-865277		3.0L (4 juntas cárter, retén trasero 2 piezas)	3.0L (4 oil pan gaskets 2 pcs. rear seal)	3.0L (4 guarniz. coppa olio, tenuta posteriore 2 pezi)	3.0L (4 joints du carter, joint arrière 2 pièces)	
7	REC17102			3.0L (1 junta cárter, 1 retén trasero)	3.0L (1 oil pan gasket 1 pc. rear seal)	3.0L (1 guarniz. coppa olio, 1 tenuta posteriore)	3.0L (1 JOINT DE CARTER, joint arrière 2 pièces)	1
	FEL17119			4.1L, 24 TORNILLOS (Cárter 16 tornillos, utilizar sellante STA82910)	4.1L, 24 BOLTS (16 bolt oil pan, use sellant STA82910)	4.1L, 24 VITI (Coppa olio 16 viti, Usare il sigillante STA82910)	4.1L 24 VIS (carter 16 vis, utiliser un scellant STA82910)	
				MANGUERA DE VACIADO	DRAIN HOSE	TÚBO DI SCARICO	TUYAU DE VIDANGE	
8	MPI305-0380	3854956	26-34217	MCM-OMC 1/2"	MCM-OMC1/2"	MCM-OMC 1/2"	MCM-OMC 1/2"	1
	MPI307-0380	3857898	24-35214	VOLVO 3/4"	VOLVO 3/4"	VOLVO 3/4"	VOLVO 3/4"	



ÁRBOL DE LEVAS

CAMSHAFT

ALBERO A CAME

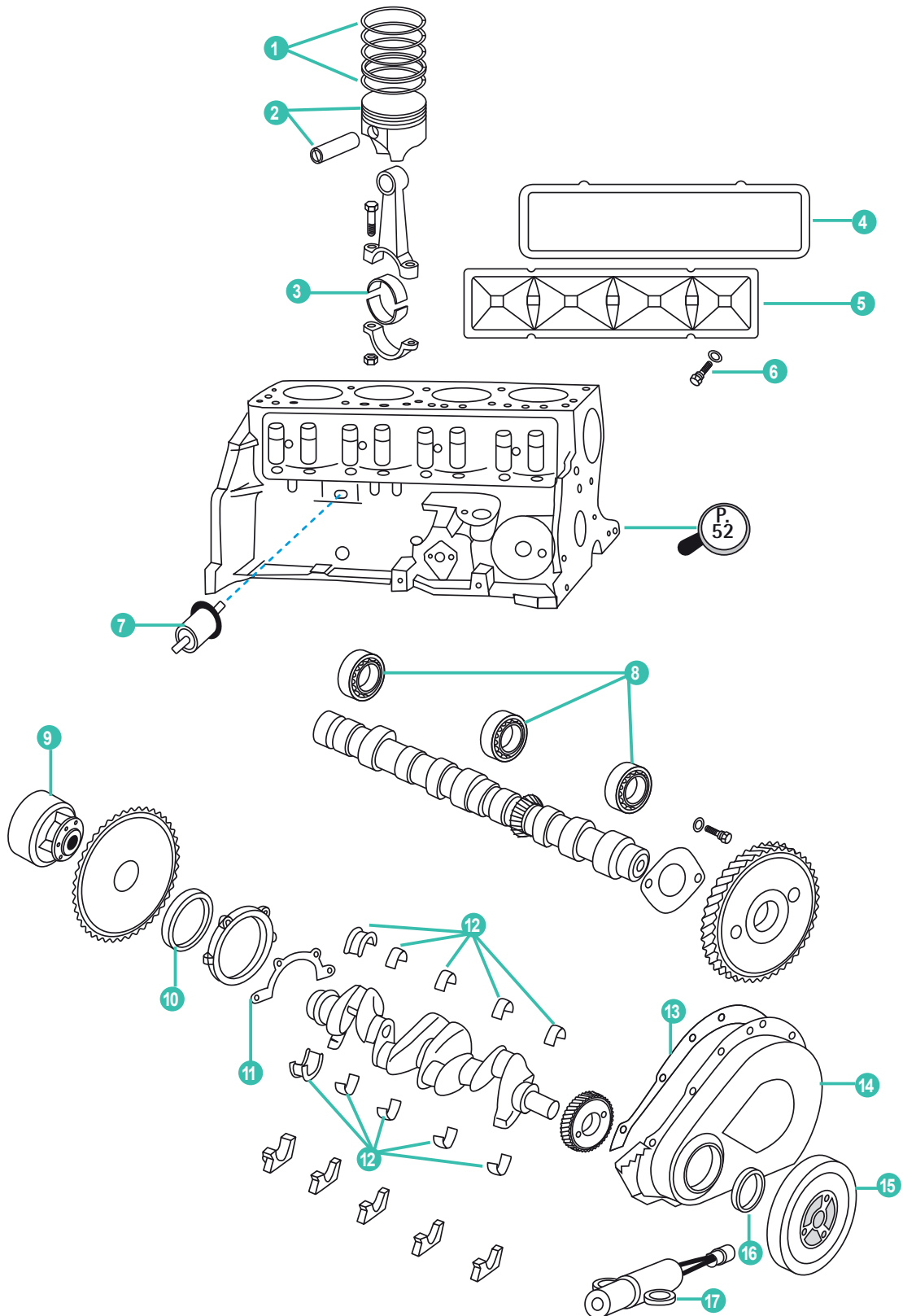
ARBRE À CAMES



REF	VOLVO	MERCURY					UN.
			KIT AROS	RING SET	KIT ANELLI	KIT DE SEGMENTS	
REC11008		39-66217	181 3.0L 0.20	181 RX 3.0L 0.20	181 RX 3.0L 0.20	181 RX 3.0L 0.20	4
1 REC11001	3853960	39-17464	181 3.0LX STD	181 3.0LX STD	181 3.0LX STD	181 3.0LX STD	4
REC11002		39-67132	4.1L STD	4.1L STD	4.1L STD	4.1L STD	6
REC11003		39-67134	4.1L 0.30	4.1L 0.30	181 0.30	181 0.30	6
REC11021			181RX 0.40	181RX 0.40	181RX 0.40	181RX 0.40	
			PISTÓN	PISTON	PISTONE	PISTON	
2 REC10001		733-803850T	181 RX 3.0L STD	181 RX 3.0L STD	181 RX 3.0L STD	181 RX 3.0L STD	4
RM733-810852	3853340	733-810852	181 3.0LX STD (alt. 1.98 x 1.98 x 4.76 mm)	181 3.0LX STD (high 1.98 x 1.98 x 4.76 mm)	181 3.0LX STD (alto 1.98 x 1.98 x 4.76 mm)	181 3.0LX STD (haute 1.98 x 1.98 x 4.76 mm)	4
			COJINETE BIELA	CONNECTING ROD BEARING	CUSCINETTO BIELLA	COUSSINETS DE BIELLE	
REC13001	3853149	23-85701	3.0L & LX STD	3.0L & LX STD	3.0L & LX STD	3.0L & LX STD	
REC13002	3856117	23-85704	3.0L & LX 0.10" / 0.25 mm	3.0L & LX 0.10" / 0.25 mm	3.0L & LX 0.10" / 0.25 mm	3.0L & LX 0.10" / 0.25 mm	
3 REC13024	3853153	23-85705	3.0L & LX 0.20" / 0.51 mm	3.0L & LX 0.20" / 0.51 mm	3.0L & LX 0.20" / 0.51 mm	3.0L & LX 0.20" / 0.51 mm	4
RM23-804982	3858954	23-804982	3.0LX & GS (Ancho 19 mm)	3.0LX & GS (Width 19 mm)	3.0LX & GS (Larghezza 19 mm)	3.0LX & GS (Largeur 19 mm)	
REC13003		23-85677	4.1L STD	4.1L STD	4.1L STD	4.1L STD	
REC13004		23-85680	4.1L 0.10" / 0.25 mm	4.1L 0.10" / 0.25 mm	4.1L 0.10" / 0.25 mm	4.1L 0.10" / 0.25 mm	
4 REC17903	3856443	27-814703	JUNTA	GASKET	GUARNIZIONE	JOINT	
FEL17926		27-34209	JUNTA: VÁLVULA 4.1L	GASKET: VALVE PUSH ROD COVER 4.1L	GUARNIZIONE: VALVOLA 4.1L	JOINT SOUPAPE 4.1L	1
5 MP0014-401	3853138	814702	TAPA	COVER	COPPERCHIO	COUVERCLE	1
6 MP0014-403	3853955	10-34470	TORNILLO	BOLT	VITE	VIS	4
7 REC8M0068784	3857532	8M0068784	SENSOR PRESIÓN DE ACEITE	OIL PRESSURE SENDER	SENSORE PRESSIONE DELL'OLIO	SONDE PRESION D'HUILE	1
8 REC13005	3852829	23-43293T	COJIENTE ÁRBOL DE LEVAS (Kit de 3)	BEARING: CAMSHAFT (Set of 3)	CUSCINETTO ALBERO A CAMME (Kit de 3)	ROULEMENT D'ARBRE A CAMES (Kit de 3)	3
9			ACOPLAMIENTO	DAMPER	ACCOPIAMENTO	ACCOUPEMENT	1
							
10 REC26-14240	3852657	26-14240	RETÉN CIGÜEÑAL RR	SEAL OIL, CRANKSHAFT RR	PARAOLIO ALBERO MOTORE RR	JOINT AR DE VILEBREQUIN RR	1
11 REC27-14241	3852656	27-881715	JUNTA PORTA RETÉN	GASKET	PARAOLIO	JOINT	1
			KIT COJINETE CIGÜEÑAL	CRANKSHAFT BEARING KIT	KIT CUSCINETTO ALBERO MOTORE	KIT PALIER VILEBREQUIN	
REC13006	3856731	23-818469001	3.0L STD	3.0L STD	3.0L STD	3.0L STD	
12 REC13007		23-818471	3.0L 0.10" / 0.25 mm	3.0L 0.10" / 0.25 mm	3.0L 0.10" / 0.25 mm	3.0L 0.10" / 0.25 mm	1
REC13026		23-818472	3.0L 0.20" / 0.51 mm	3.0L 0.20" / 0.51 mm	3.0L 0.20" / 0.51 mm	3.0L 0.20" / 0.51 mm	
REC13008		23-85675	4.1L STD	4.1L STD	4.1L STD	4.1L STD	
REC13009		23-85713	4.1L 0.10" / 0.25 mm	4.1L 0.10" / 0.25 mm	4.1L 0.10" / 0.25 mm	4.1L 0.10" / 0.25 mm	
13 REC27-49953	3852691	27-49953	JUNTA: TAPA DISTRIBUCIÓN	GASKET: DISTRIBUTOR CAP	GUARNIZIONE: COPPERCHIO DISTRIBUZIONE	JOINT: CARTER DE DISTRIBUTION	1
14 REC59341A1	3853135	59341A1	TAPA: DISTRIBUIDOR 181	COVER: TIMING 181	COPPERCHIO: DISTRIBUZIONE 181	CARTER DISTRIBUTION 181	1
15 MP0025-004	3852662	55045T	BADAMPER: COUPLEAL181	BALANCER: HARMONIC 181	DAMPER: COUPLEAL 181181	AMORTISSEUR DE VIBRATION 181	1
16 REC3853341	3853341	26-97335	RETÉN	SEAL OIL	PARAOLIO	JOINT	1
17 REC8M0082988		8M0082988	SENSOR CIGÜEÑAL MPI	CRANKSHAFT MPI SENSOR	SENSORE ALBERO MOTORE MPI	SONDE VILEBREQUIN MPI	1
18 REC095009		220-801873	VOLANTE 12-3/4"	FLYWHEEL 12-3/4"	VOLANTE 12-3/4"	VOLANT 12-3/4"	1
			CORONA DENTADA	GEAR RING	CORONA DENTATA	COURONNE DENTÉE	
19 REC157-N	3853143		157 dientes Ø12"	157 Teeth Ø 12"	157 denti Ø12"	157 dents Ø12"	1
REC1685			168 dientes Ø13-3/4"	168 Teeth Ø 13-3/4"	168 denti Ø13-3/4"	168 dents Ø13-3/4"	
			KIT JUNTAS	GASKET SET	KIT GAURNIZIONE	KIT JOINTS	
20 REC17200			2.5L / 3.0L (4L) (CON admisión)	2.5L / 3.0L (4L) (WITH Intake Gasket)	2.5L / 3.0L (4L) (CON aspirazione)	2.5L / 3.0L (4L) (AVEC admission)	1
FEL17219			4.1L (6L) (SIN admisión)	4.1L (6 In Line) (WITHOUT Intake Gasket)	4.1L (6L) (SENZA aspirazione)	4.1L (6L) (SANS admission)	

181 CID 3.0L

MOTORES GM • GM ENGINES • SMOTORI GM • MOTEURS GM

DISTRIBUIDOR      DISTRIBUTOR      DISTRIBUZIONE      DISTRIBUTEUR

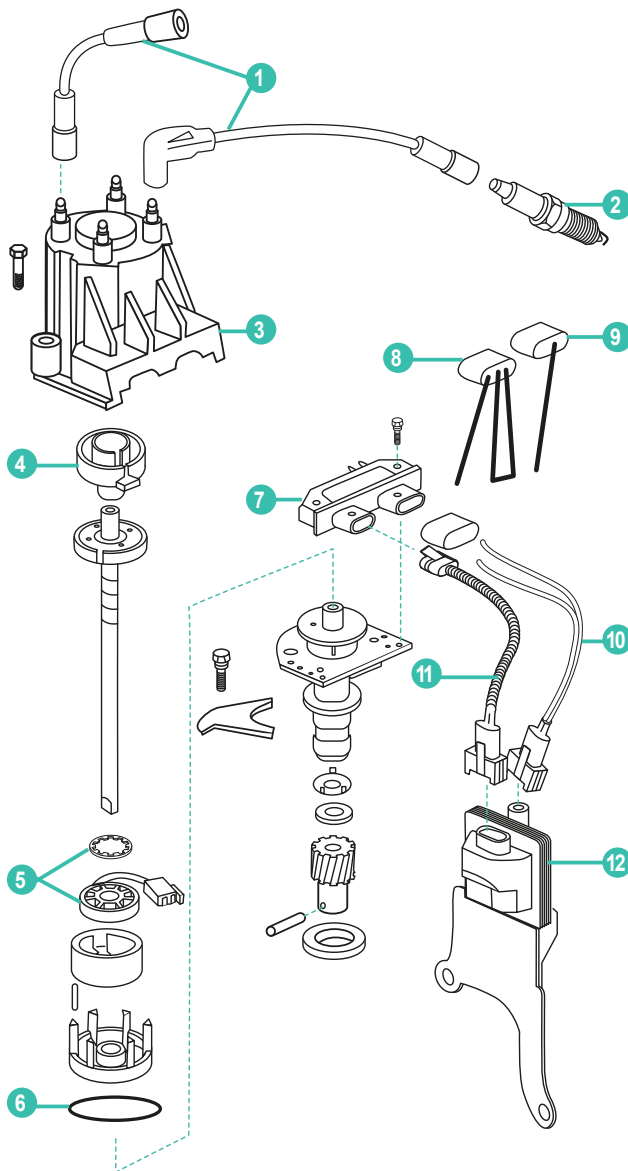

	REF	VOLVO	MERCURISER				UN.	
1	REC15-405	3888324	84-816761Q14	KIT CABLES ARRANQUE	IGNITION WIRE SET	KIT CAVI ACCENSIONE	KIT FAISCEAU DE BOUGIE	1
2				BUJÍA	SPARK PLUG	CANDELE	BOUGIES	4
3	REC3854260	3854260	811635T3	TAPA DISTRIBUIDOR RX	CAP: DISTRIBUTOR RX	COPERCHIO DISTRIBUZIONE RX	TETE D'ALLUMEUR RX	1
4	REC3854261	3854261	8M6001254	ROTOR DISTRIBUIDOR RX	ROTOR: DISTRIBUTOR RX	ROTORE: DISTRIBUZIONE RX	DOIGT D'ALLUMEUR RX	1
5	REC3854001	3854001	811639T	MÓDULO IMPULSOS	MODULE	MODULO	MODULE D'ALLUMAGE	1
6	REC27-87707	3852660	27-87707	JUNTA	GASKET	GUARNIZIONE	JOINT	1
7	REC3854003	3854003	811637001	MÓDULO: DISTRIBUIDOR DELCO	MODULE: DISTRIBUTOR DELCO	MODULO DISTRIBUZIONE DELCO	MODULE D'ALLUMEUR DELCO	1
8	REC91-888863	885163	91-888863	PUENTE DE DISTRIBUCIÓN	TIMING JUMPER: IGNITION	PONTE DI DISTRIBUZIONE	TIMING JUMPER ALLUMAGE DELCO HEI/EST	1
9	REC294005		807964A1	CABLE ARRANQUE: INTERRUPTOR	IGNITION WIRE: SHIFT INTERRUPTER	CAVO ACCENSIONE: INTERRUPTORE	FAISCEAU POUR SHIFT INTERRUPTEUR	1
10	REC500442			CABLE ALIMENTACIÓN BOBINA	WIRE LEAD: COIL TO DIST.	CAVI: BOBINA DISTRIBUZIONE	FAISCEAU POUR BOBINE	1
11	REC84-817376T01	3854084	84-817376T01	CABLE: BOBINA-DISTRIBUIDOR	WIRE LEAD: COIL HARNESS-DISTRIBUTOR	CAVO: BOBINA-DISTRIBUTORE	FAISCEAU POUR BOBINE	1
12	REC3854002	3854002	898253T27	BOBINA: DELCO	COIL: DELCO	BOBINA: DELCO	BOBINE D'ALLUMAGE HEI	1
13	REC817377		817377	DISTRIBUIDOR ELECTRÓNICO (3, 4 y 7 incluidos)	DISTRIBUTOR: ELECTRONIC (3, 4 & 7 Included)	DISTRIBUZIONE ELECTRONIC (include 3, 4 e 7)	DISTRIBUTEUR ELECTRONIQUE (3, 4 et 7 inclus)	1



262 CID  
V6, 4.3L

CARTER ACEITE

OIL PAN

COPPA OLIO

CARTER D'HUILE

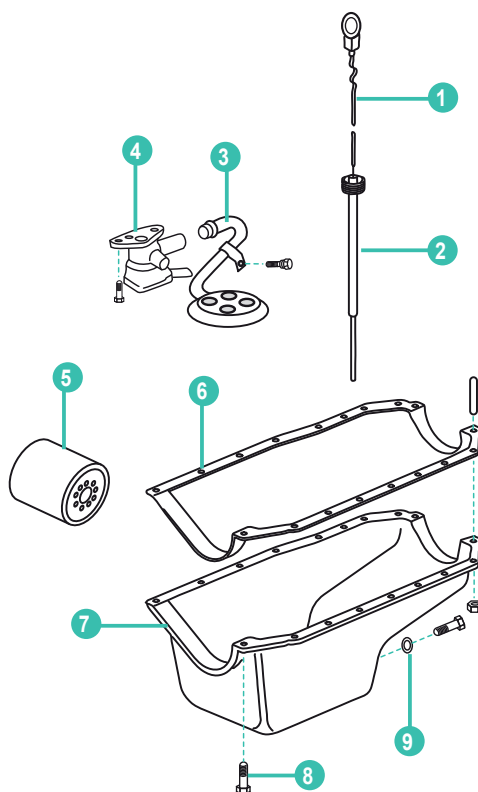
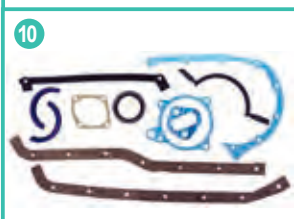

	REF	VOLVO	MERCURISER					UN.
1	REC551455		861942 17	VARILLA ACEITE 262/350	DIPSTICK 262/350	ASTA DI LIVELLO 262/350	JAUGE D'HUILE 262/350	1
				VARILLA TUBO	DIPSTICK TUBE	ASTA DI LIVELLO TUBO	TIGE TUBO	
2	MP0307-002	856248	12117A5	262 (BLOQUE)	262 (BLOCK)	262 (BLOCCO)	262 (BLOC)	1
	MP0009-002N5	3860214	860209A1	4.3V (1999+) (CÁRTER)	4.3V (1999+) (OIL PAN)	4.3V (1999+) (COPPA OLIO)	4.3V (1999+) (CARTER)	
3	MP0007-256	3853197	809908 1	TUBO Y FILTRO: BOMBA ACEITE	TUBE & SCREEN: OIL PUMP	TUBO E FILTRO: POMPA OLIO	TUBE ET FILTRE: POMPE A HUILE	1
				BOMBA ACEITE	OIL PUMP	POMPA OLIO	POMPE A HUILE	
4	REC14101	3853851	17617	PREVORTEC	PRE VORTEC	PRE VORTEC	PRE VORTEC	1
	RM809907002	3856125	809907002	VORTEC	OIL VORTEC	VORTEC	VORTEC	
5				FILTRO ACEITE 262	FILTER: OIL 262	FILTRO OLIO: 262	FILTRE A HUILE: 262	1
				JUNTA CÁRTER	GASKET OIL PAN	GUARNIZIONE COPPA OLIO	JOINT DE CARTER	
	REC17970	855729	27-42797	(4 Piezas)	(4 PCS.)	(4 peci)	(4 Pièces)	
6	REC17971	3852655	27-883964T	(1 Pieza)	(1 PC.)	(1 pece)	(1 Pièce)	1
	REC27-142471		27-142471	262 VORTEC (1 Pieza)	262 VORTEC (1 PC.)	262 VORTEC (1 pece)	262 VORTEC (1 pièce)	
	REC21124852	21124852	14247T02	262 VORTEC (1 Pieza) (2008+)	262 VORTEC (1 PC.) (2008+)	262 VORTEC (1 pece) (2008+)	262 VORTEC (1 pièce) (2008+)	
	REC15351	856386	14244T	CARTER	OIL PAN	COPPA OLIO	CARTER D'HUILE	
				262	262	262	262	
7	RM809980T1	21124851	809980T1	ALUMINIO BLOQUE GM 8LK, 8LJ VORTEC	ALUMINUM GM BLOCK 8LK, 8LJ VORTEC	ALLUMINIO BLOCCO GM 8LK, 8LJ VORTEC	AL BLOC GM 8LK, 8LJ VORTEC	1
	RM804912T01	21124851	804912T01	BLOQUE GM 9LK, 9LJ, 0LJ	ALUMINUM GM BLOCK: 9LK, 9LJ, 0LJ	ALLUMINIO BLOCCO GM 9LK, 9LJ, 0LJ	AL BLOC GM 9LK, 9LJ, 0LJ	
8	RECPNRS-1100	940135	14070	KIT TORNILLO CÁRTER	BOLT SET: OIL PAN	KIT VITE: COPPA OLIO	KIT VIS CARTER	1
9	REC27-49955	3851981	27-49955	JUNTA	GASKET	GUARNIZIONE	JOINT	1
				KIT JUNTAS	GASKET SET	KIT GAURNIZIONE	KIT JOINTS	
10	REC17110			4 juntas cárter 2 juntas retén trasero	4 Oil pan gaskets 2 pcs rear seal	4 guarnizione coppa olio 2 guarnizione tenuta posteriore	4 joints carter 2 joints arrières	1
	REC17116			1 junta cárter retén trasero 1 pieza	1 Oil pan gasket 1 pcs rear seal	1 guarn. coppa olio 1 tenuta posteriore	1 JOINT DE CARTER joint arrière 1 pièce	
				MANGUERA DE VACIADO	DRAIN HOSE	TUBO DI SCARICO	TUYAU DE VIDANGE	
11	MPI305-0380			MCM-OMC 1/2"	MCM-OMC1/2"	MCM-OMC 1/2"	MCM-OMC 1/2"	1
	MPI307-0380			VOLVO 3/4"	VOLVO 3/4"	VOLVO 3/4"	VOLVO 3/4"	
	MPI309-0380			FORD 14 mm	FORD 14mm	FORD 14mm	FORD 14mm	



ÁRBOL DE LEVAS

CAMSHAFT

ALBERO A CAME

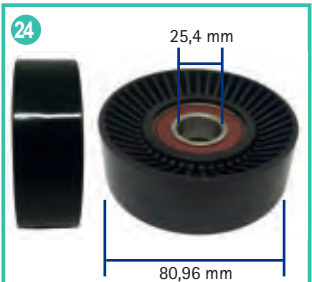
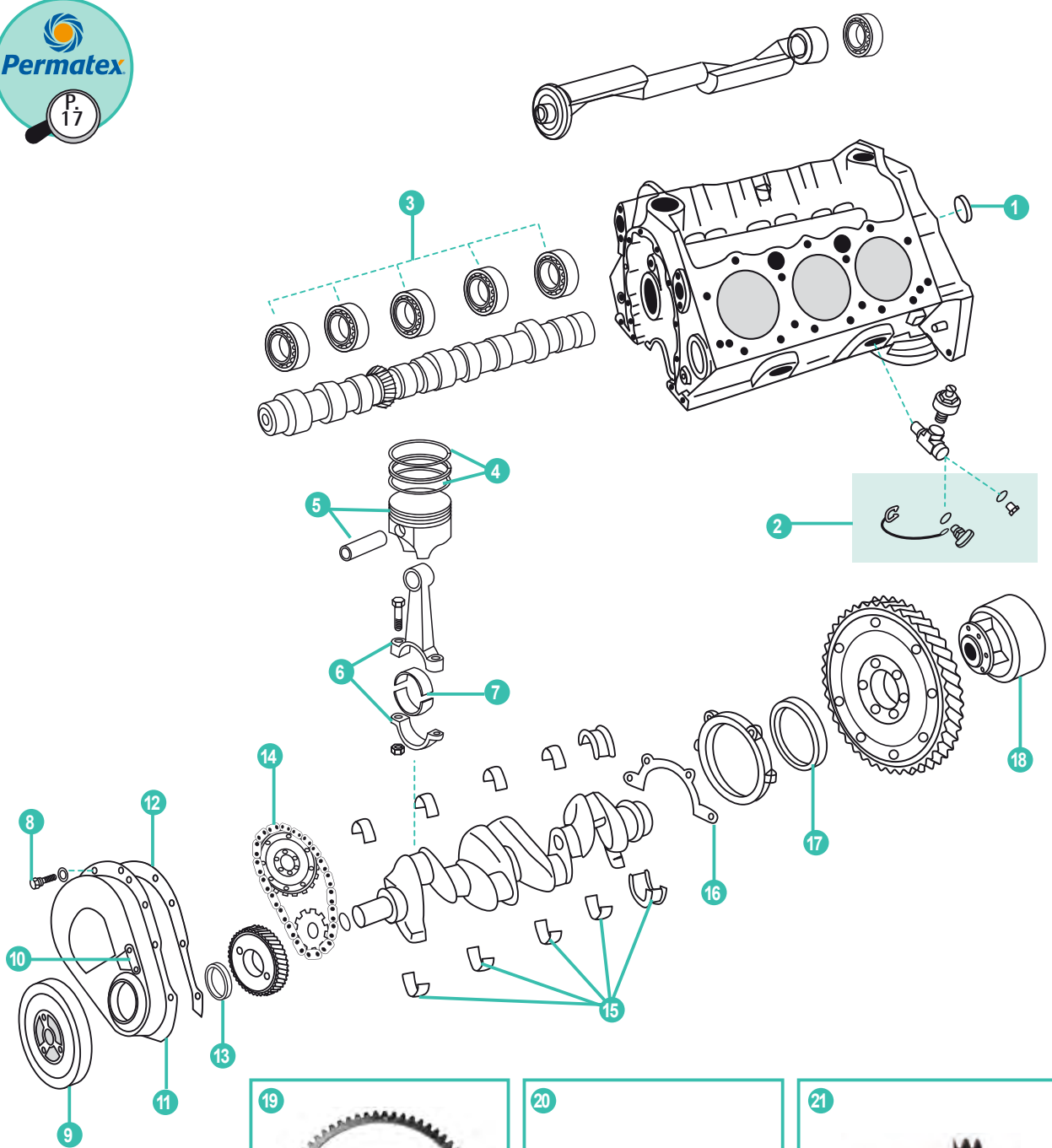
ARBRE À CAMES



	REF	VOLVO	MERCURISER					UN.
1	MP0009-208	3853209	22-72640	KIT TAPÓN LATÓN DE EXPANSION	BRASS EXPANSION PLUG KIT	KIT TAPPO ESPANSIONE IN OTTONE	KIT PASTILLE DE SABLAGE	1
2	REC38201	21114522		RACORD DRENAJE COMPLETO	FULL FEETING	RACCORDO COMPLETO	RACORD VIDANGE COMPLET	1
3	REC13014		23-85674	KIT COJINETE: ÁRBOL LEVAS	BEARING KIT: CAMSHAFT	KIT CUSCINETTO: ALBERO A CAMME	KIT ROULEMENT: ARBRE A CAMES	1
				KIT AROS PISTÓN	RING SET	KIT ANELLI PISTONE	KIT DE SEGMENTS	
	REC11001	3853960	39-17464	262 (alto 81 mm)	262 (height 81 mm)	262 (Alt. 81 mm)	262 (hauteur 81 mm)	
	REC11004	21179959	39-801861 1	V6 (1996+ STD)	V6 (1996+ STD)	V6 (1996+ STD)	V6 (1996+ STD)	
4	REC11016			V6 (1996+ 0.30)	V6 (1996+ 0.30)	V6 (1996+ 0.30)	V6 (1996+ 0.30)	6
	REC11005	3853960	39-17464	262/350 (-1995 STD)	262/350 (-1995 STD)	262/350 (-1995 STD)	262/350 (-1995 STD)	
	REC11006	3853961	39-17465	262 (-1995 0.30)	262 (-1995 0.30)	262 (-1995 0.30)	262 (-1995 0.30)	
	REC11011			262/350 (0.40) 71 mm	262/350 (0.40) 71 mm	262/350 (0.40) 71 mm	262/350 (0.40) 71 mm	
				PISTÓN	PISTON	PISTONE	PISTON	
	REC10004	3854219	735-850097	262/350 (-1995 STD) (aros: 1.98x1.98x4.76mm)	262/350 (-1995 STD) (rings: 1.98x1.98x4.76mm)	262/350 (-1995 STD) (anelli: 1.98x1.98x4.76mm)	262/350 (-1995 STD) (seg: 1.98x1.98x4.76 mm)	
	REC10018			262/350 (-1995 0.40) (aros: 1.98x1.98x4.76mm)	262/350 (-1995 0.40) (rings: 1.98x1.98x4.76mm)	262/350 (-1995 0.40) (anelli: 1.98x1.98x4.76mm)	262/350 (-1995 0.40) (seg: 1.98x1.98x4.76 mm)	
5	REC10005	3854221	735-850098	262 (-1995 0.30) (aros: 1.98x1.98x4.76mm)	262 (-1995 0.30) (rings: 1.98x1.98x4.76mm)	262 (-1995 0.30) (anelli: 1.98x1.98x4.76mm)	262 (-1995 0.30) (seg: 1.98x1.98x4.76 mm)	6
	REC10006	21179952	735-835001T	V6 (1996+ STD) (aros: 1.5x1.95x3mm)	V6 (1996+ STD) (rings: 1.5x1.5x3mm)	V6 (1996+ STD) (anelli: 1.5x1.5x3mm)	V6 (1996+ STD) (seg: 1.5x1.5x3 mm)	
	REC10013			V6 (1996+ 0.30) (aros: 1.5x1.95x3mm)	V6 (1996+ 0.30) (rings: 1.5x1.5x3mm)	V6 (1996+ 0.30) (anelli: 1.5x1.5x3mm)	V6 (1996+ 0.30) (seg: 1.5x1.5x3 mm)	
6	MP0009-036	21179974	614-811839T02	BIELA: 262	CONNECTING ROD: 262	BIELLA: 262	BIELLE: 262	6
				COJINETE BIELA	CONNECTING ROD BEARING	CUSCINETTO BIELLA	COUSSINETS DE BIELLE	
7	REC13010	21179992	23-11992001	262	262	262	262	6
	REC13011		23-811858001	262, 0.10 (0.25 mm)	262, 0.10 (0.25 mm)	262 0.10 (0.25 mm)	262 0.10 (0.25 mm)	
8	REC859021	3856133	10-35366	KIT TORNILLOS: TAPA DISTRIBUCIÓN	KIT BOLTS: TIMING COVER	KIT VITE: COPERCHIO DISTRIBUZIONE	KIT DE VIS: CARTER DE DISTRIBUCION	1
				AMORTIGUADOR COUPLEAL	DAMPER COUPLEAL	AMMORTIZZATORE COUPLEAL	DAMPER	
9	MP0009-004LC	3857474	809892T	262 Ø170 mm VORTEC	262 Ø170 mm VORTEC	262 Ø170 mm VORTEC	262 Ø170 mm VORTEC	1
	REC888776T	3859022	888776T	262 (2002+) MPI Ø170mm	262 (2002+) MPI Ø170mm	262 (2002+) MPI Ø170mm	262 (2002+) MPI Ø170mm	
10	MP0011-045	3853195	75435A1	INDICADOR DE DISTRIBUCIÓN	INDICATOR TIMING	INDICATORE DISTRIBUZIONE	INDICATEUR CALAGE DE DISTRIBUCION	1
				TAPA DISTRIBUCIÓN	TIMING COVER	COPERCHIO DISTRIBUZIONE	COUVERCLE DISTRIBUCION	
	REC15251	3853194	14249A2	262 (-1995)	262 (-1995)	262 (-1995)	262 (-1995)	
11	REC15252	3855735	809893	4.3V (1997+) (Sin sensor) Plástico	4.3v (1997+) (Without Sensor) Plastic	4.3V (1997+) (senza sensore) Plastica	4.3V (1997+) (Sans sonde) Plastique	1
	REC15253	3859023	8M0069799	4.3V (1997+) (con sensor) Plástico	4.3v (1997+) (With Sensor) Plastic	4.3V (1997+) (con sensore) Plastica	4.3V (1997+) (Avec sonder) Plastique	
	REC21180065	21180065		V6 (2007+) AL	V6 (2007+) AL	V6 (2007+) AL	V6 (2007+) AL	
12	REC27-14250	3852654	27-14250	JUNTA: TAPA DISTRIBUCIÓN	GASKET: ENGINE FRONT COVER	GUARNIZIONE COPERCHIO FRONTALE	JOINT CARTER DE DISTRI	1
				RETÉN ACEITE: CIGÜEÑAL FRONTAL PRE-VORTEC	SEAL: CRANKSHAFT FRONT OIL PRE-VORTEC	PARAOILIO: ALBERO A GOMITO FRONTALE PRE-VORTEC	JOINT SPI VILEBREQUIN PRE-VORTEC	
13	REC3853341	3853341	26-97335	CADENA DISTRIBUCIÓN	TIMING CHAIN	CATENA DISTRIBUZIONE	KIT CHAINE DISTRIBUCION	1
14	REC12502		11985	262 (-1986)	262 (-1986)	262 (-1986)	262 (-1986)	1
	RM883494	3859021	883494	4.3L (1998+)	4.3L (1998+)	4.3L (1998+)	4.3L (1998+)	
				KIT COJINETE CIGÜEÑAL	CRANKSHAFT BEARING KIT	KIT CUSCINETTO ALBERO MOTORE	KIT PALIER VILEBREQUIN	
15	REC13012	3853215	23-818465	STD	STD	STD	STD	1
	REC13013	856342	23-818467	0.10 (0.25 mm)	0.10 (0.25 mm)	0.10 (0.25 mm)	0.10 (0.25 mm)	
16	REC27-14241	3852656	27-14241	JUNTA RETÉN ACEITE: CIGÜEÑAL RR HSG	GASKET: CRANKSHAFT RR OIL SEAL HSG	GUARNIZIONE: PARAOILIO: ALBERO A GOMITO RR HSG	JOINT: JOINT AR DE VILEBREQUIN RR HSG	1
				RETÉN ACEITE CIGÜEÑAL	CRANKSHAFT SEAL	PARAOILIO ALBERO A GOMITO	JOINT HUILLE VILEBREQUIN	
17	REC26-14240	3852657	26-8M0077606	RR PRE-VORTEC	RR PRE-VORTEC	RR PRE-VORTEC	RR PRE-VORTEC	1
	RM26-879194364	3858698	26-879194364	RR VORTEC Y MPI	RR VORTEC & MPI	RR VORTEC E MPI	RR VORTET ET MPI	
18				  ACOPLAMIENTO	DAMPER	ACCOPIAMENTO	ACCOUPEMENT	1
				CORONA DENTADA	GEAR RING	CORONA DENTATA	COURONNE VOLANT MOTEUR	
19	REC157-N			157 dientes Ø12"	157 Teeth Ø12"	157 denti Ø12"	157 dents Ø12"	1
	REC1685	3853143		168 dientes Ø13-3/4"	168 Teeth Ø13-3/4"	168 denti Ø13-3/4"	168 dents Ø13-3/4"	
				KIT JUNTAS	GASKET SET	KIT GUARNIZIONE	KIT JOINTS	
20	REC17210			Excepto motores eje equilibrado	Except balanced shaft	Ecceetto motori asse equilibrato	Sauf moteurs à arbre d'équilibrage	1
	REC17211			Motores eje equilibrado	Balanced shaft engines	Motorig asse equilibrato	Moteurs à arbre d'équilibrage	
21	MP514516	855283		POLEA DE LA BOMBA DE DOBLE RANURA Ø150 mm	DUAL GROOVE PUMP PULLEY Ø150 mm	PULEGGIA POMPA DOPPIA SCANALATURA Ø150mm	POULIE POMPE DE BRASSAGE Ø 150 mm	1
22	MP514693	835407	807730	POLEA CIGÜEÑAL DOBLE RANURA Ø 173 mm	DUAL GROOVE CRANK PULLEY Ø 173 mm	PULEGGIA ALBERO MOTORE, DOPPIA SCALANATURA Ø 173 mm	POULIE DE VILEBREQUIN 2 GORGES Ø 173 mm	1
23	REC807757T	3860201	807757T	POLEA SERPENTINA MCM (Plástico) 3" OD	SERPENTINE PULLEY MCM (Plastic) 5" OD	PULEGGIA A SERPENTINA MCM (plastica) 5" OD	POULIE COMPOSITE SERPENTINE 5" OD	1
24	REC8M6500024	865598	8M6500024	POLEA	PULLEY	PULEGGIA	POULIE	1
25	REC864297T01	3858979	864297T01	SENSOR POSICIÓN CIGÜEÑAL	CRANKSHAFT SENSOR	SENSORE POSIZIONE ALBERO MOTORE	SONDE POSITION VILEBREQUIN	1
	REC21124849	21124849						

CULATA

CYLINDER HEAD

TESTATA

CULASSE

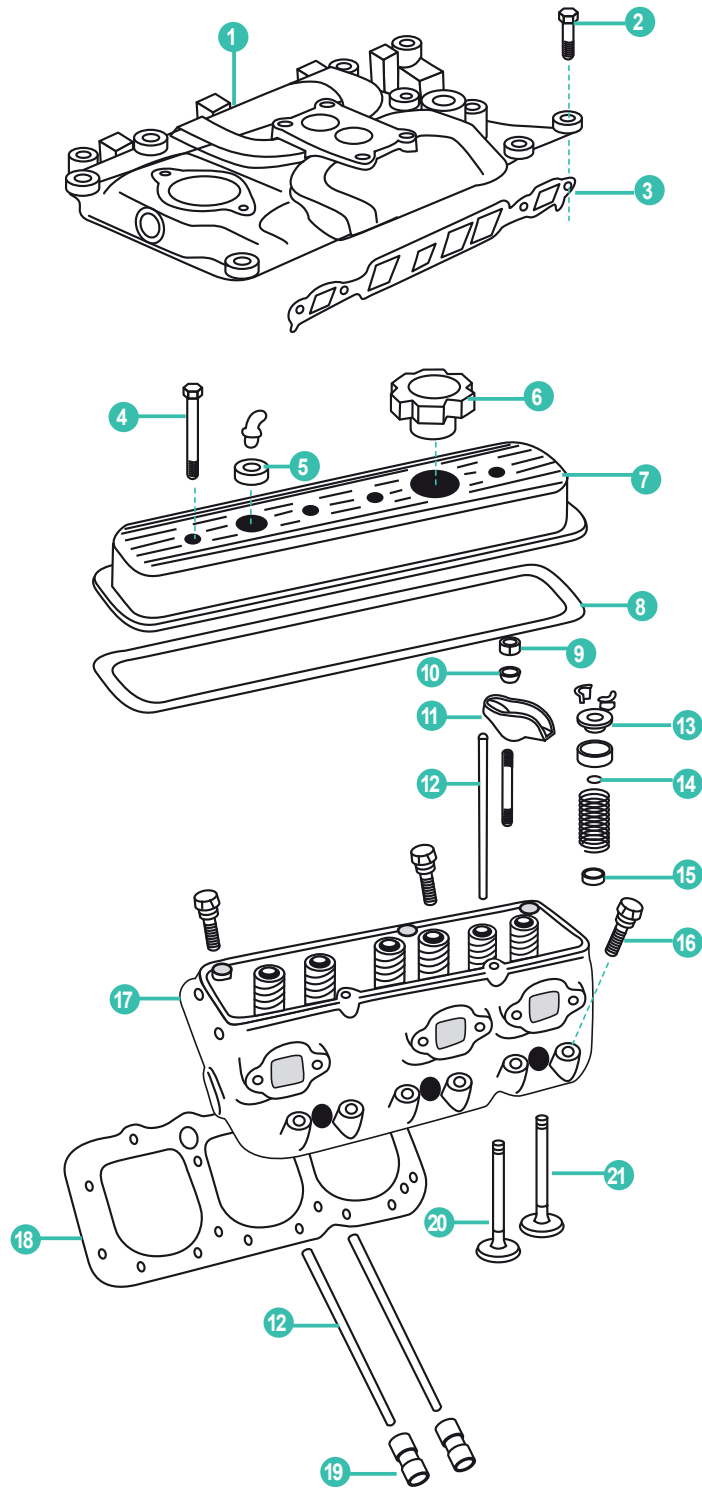

REF

REC27-99757





	REF	VOLVO	MERCURUISER					UN.
				COLECTOR ADMISIÓN	INTAKE MANIFOLD	COLLETTORE ASPIRAZIONE	COLLECTEUR D'AMISSION	
1	MP425036	3855806	824330T1	VORTEC 4BBL	VORTEC 4BBL	VORTEC 4BBL	VORTEC 4BBL	1
	MP425024	3855805	824324T	VORTEC 2BBL	VORTEC 2BBL	VORTEC 2BBL	VORTEC 2BBL	
2	MP001204	3856765	10-835004	TORNILLO: COLECTOR ADMISION	BOLT: INTAKE MANIFOLD	VITE: COLLETTORE ASPIRAZIONE	VIS	8
3	REC17210	857177	27-11977	JUNTA COLECTOR ADMISION	GASKET: INTAKE MANIFOLD	GUARNIZIONE: COLLETTORE ASPIRAZIONE	JOINT	
	REC824326002	3855807	27-824326002	JUNTA: COLECTOR ADMISION VORTEC	GASKET: INTAKE MANIFOLD VORTEC	GUARNIZIONE: COLLETTORE ASPIRAZIONE VORTEC	JOINT VORTEC	2
4	MP0009-107	3856135	10-17344	TORNILLO: TAPA VÁLVULA	BOLT: VALVE COVER	VITE: COPERCHIO VALVOLA	VIS: CACHE CULBUTEUR	6
5	RECTW9760	835415	8M0071559	ANILLO: TAPA VÁLVULA	GROMMET: VALVE COVER	ANELLO: COPERCHIO VALVOLA	BAGUE CACHE CULBUTEUR	2
6	REC6532	3854008	36-18710002	TAPÓN ACEITE	CAP OIL FILL	TAPPO OLIO	BOUCHON HUILE	2
				TAPA VÁLVULA	COVER VALVE	COPERCHIO VALVOLA	CACHE CULBUTEUR	
7	MP0009-194LC	3854948	827150	VORTEC (Con tapón)	VORTEC (With Seal)	VORTEC (Con cappuccio)	VORTEC (avec bouchon)	
		3854949	827149	VORTEC (Sin tapón)	VORTEC (Without Seal)	VORTEC (Senza cappuccio)	VORTEC (Sans bouchon)	1
		3854945	14251	PREVORTEC (Con tapón)	PREVORTEC (With Seal)	PREVORTEC(Con cappuccio)	PREVORTEC (avec bouchon)	
		3854945	14252	PREVORTEC (Sin tapon)	PREVORTEC (Without Seal)	PREVORTEC (Senza cappuccio)	PREVORTEC (Sans bouchon)	
				KIT JUNTAS TAPA VÁLVULA	GASKET KIT, VALVE COVER	KIT GUARNIZIONE COPERCHIO VALVOLA	KIT JOINTS CACHE CULBUTEUR	
8	REC17920	3854300	27-11988	PREVORTEC	PRE VORTEC	PREVORTEC	PREVORTEC	2
	REC17921	3854942	27-827154	VORTEC	VORTEC	VORTEC	VORTEC	
9	MP0007-122	3853004	11-34516	TUERCA: BRAZO BALANCÍN	NUT: ROCKER ARM	DADO: BILANCERE	ECROU DE CULBUTEUR	12
10	RM59340	3853198	59340	ROTOR: VÁLVULA	ROTATOR: VALVE	ROTORE: VALVOLA	COUPELLE POUR SOUPAPE ECHAPPEMENT	6
11	REC10352	3853158	35329	BRAZO BALANCÍN	ARM: ROCKER	BILANCERE	CULBUTEUR	12
				VARILLA	PUSH ROD	ASTA DI BIELLA	TIGE DE CULBUTEUR	
12	REC12002	3853170	17739	262 (1986+)	262 (1986+)	262 (1986+)	262 (1986+)	12
	REC12000	3853157	99948	262 (-1986)	262 (-1986)	262 (-1986)	262 (-1986)	
13	MP0007-378	3853229	48348	TAPÓN: MUELLE VÁLVULA	CAP: VALVE SPRING	TAPPO: MOLLA VALVOLA	BOUCHON: RESSORT DE SOUPAPE	6
14	REC26-34217	3854956	26-34217	RETÉN	SEAL	TENUTA	JOINT	12
15	REC70817B	3853226	26-97664	RETÉN: VÁSTAGO VÁLVULA DE ADMISION	SEAL: INTAKE VALVE STEM	GUARNIZIONE: ASTA VALVOLA ASPIRAZIONE	JOINT DE QUEUE DE SOUPAPE	6
				TORNILLO CULATA	CYLINDER HEAD BOLT	VITE TESTATA	VIS DE CULASSE	
16	MP0007-027	3856122	10-11966	LARGO (,437-14x1.750)	LONG (,437-14x1.750)	LUNGO (,437-14x1.750)	LONG (,437-14X1.750)	10
	MP0007-028	3856123	10-11967	MEDIANO (,437-14x3.00)	MEDIUM (,437-14x3.00)	MEDIO (,437-14x3.00)	MOYEN (,437-14X3.00)	4
	MP0007-029	3856124	10-11968	CORTO	SHORT	CORTO	COURT	12
17				 CULATA	CYLINDER HEAD	TESTATA	CULASSE	2
18	REC17010	3854299	27-879150140	JUNTA: CULATA	GASKET: CYLINDER HEAD	GUARNIZIONE: TESTATA	JOINT DE CULASSE	2
				EMPUJADOR VÁLVULA	LIFTER VALVE	ALZA VALVOLA	POUSSOIR HYDRAULIQUE	
19	REC14001	3855811	811844T	4.3 VORTEC (1996+)	4.3 VORTEC (1996+)	4.3 VORTEC (1996+)	4.3 VORTEC (1996+)	
	REC14001	856397	17340T	262 (1987+)	262 (1987+)	262 (1987+)	262 (1987+)	12
	REC14000	3853954	72638	262 (-1986)	262 (-1986)	262 (-1986)	262 (-1986)	
				VÁLVULA ADMISION	INTAKE VALVE	VALVOLA ASPIRAZIONE	SOUPAPE ADMISION	
20	REC13506	841873	97661	262 (49-8,8-124)	262 (49-8,8-124)	262 (49-8,8-124)	262 (49-8,8-124)	6
	REC13507	3855810	809992	262 VORTEC (1993+) (49,2-8,7-124)	262 VORTEC (1993+) (49,2-8,7-124)	262 VORTEC (1993+) (19,2-8,7-124)	262 VORTEC (1993+) (19,2-8,7-124)	
				VÁLVULA ESCAPE	EXHAUST VALVE	VALVOLA SCARICO	SOUPAPE D'ECHAPPEMENT	
21	REC13502	856368	85803	262 (38,2-8,8-125,2)	262 (38,2-8,8-125,2)	262 (38,2-8,8-125,2)	262 (38,2-8,8-125,2)	6
	REC13505	3855808	824317 1	262 VORTEC (1993+) (38-8,7-125)	262 VORTEC (1993+) (38-8,7-125)	262 VORTEC (1993+) (38-8,7-125)	262 VORTEC (1993+) (38-8,7-125)	

CARBURACIÓN      CARBURATION      CARBURAZIONE      CARBURATION

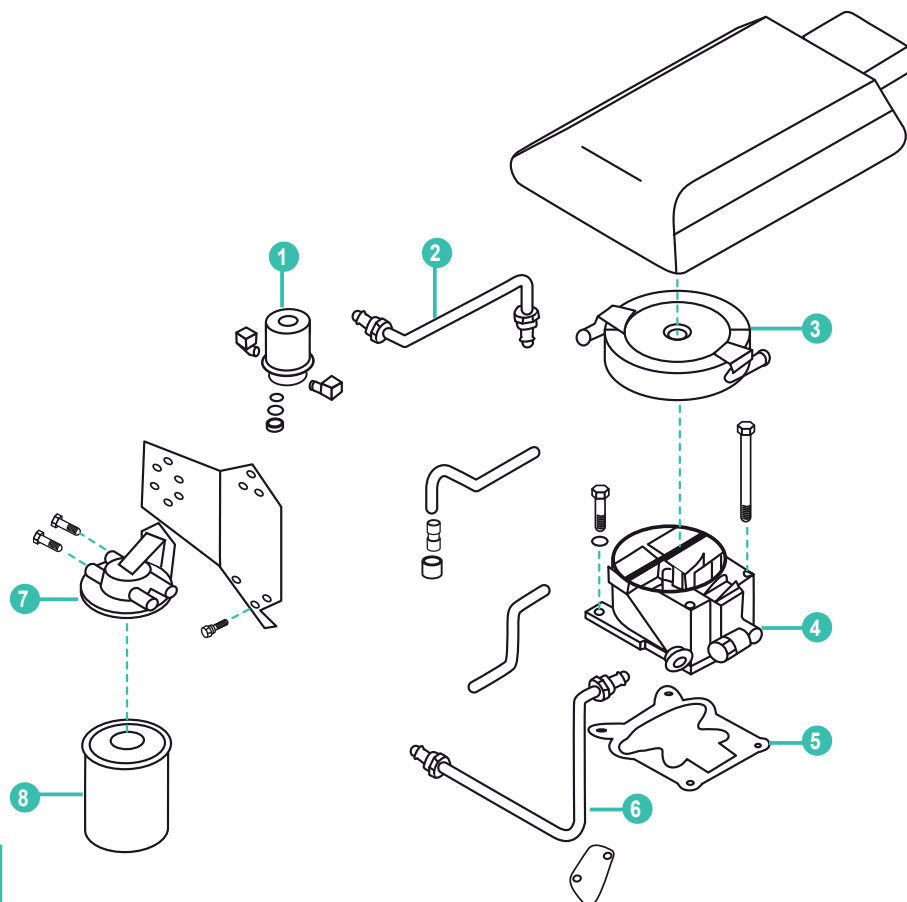

REF  
REC18-8114  
REC18-8115

REF	VOLVO	MERCRUISER					UN.
1			BOMBA COMBUSTIBLE	FUEL PUMPS	POMPA CARBURANTE	POMPE A CARBURANT	1
MP429415			TUBO BOMBA	FUEL LINE: SEP-PUMP PORT	TUBO POMPA	TUYAU POMPE	1
3	REC805298A1	3854026 805016A1	PARALLAMAS 262/350 STD	FLAME ARRESTOR 262/350 STD	ANTIFIAMMA 262/350 STD	PARE FLAMME	1
4			CARBURADOR	CARBURETOR	CARBURATORE	CARBURATEUR	1
MP426422	3854346		NUEVO CARBURADOR 262 HOLLEY 2 BBL	NEW CARBURETOR 262 HOLLEY 2 BBL	NUOVO CARBURATORE 262 HOLLEY 2 BBL	CARBURATEUR 262 HOLLEY 2 BBL NEUF	
5			JUNTA CARBURADOR	GASKET CARBURETOR	GUARNIZIONE CARBURATORE	JOINT CARBURATEUR	1
6	MP429905		TUBO BOMBA COMBUSTIBLE A CARBURADOR	FUEL LINE FUEL PUMP TO CARBURETOR	TUBO POMPA CARBURANTE A CARBURATORE	TUYAU POMPE A CARBURANT VERS CARBURATEUR	1
7	REC25000		BRACKET	BRACKET	BRACKET	SUPPORT	1
8			FILTRO COMBUSTIBLE CON SEPARADOR DE AGUA	FUEL FILTER / WATER SEPARATOR	FILTRO CARBURANTE CON SEPARATORE D'ACQUA	FILTRE SEPARATEUR	1

DISTRIBUIDOR      DISTRIBUTOR      DISTRIBUZIONE      DISTRIBUTEUR

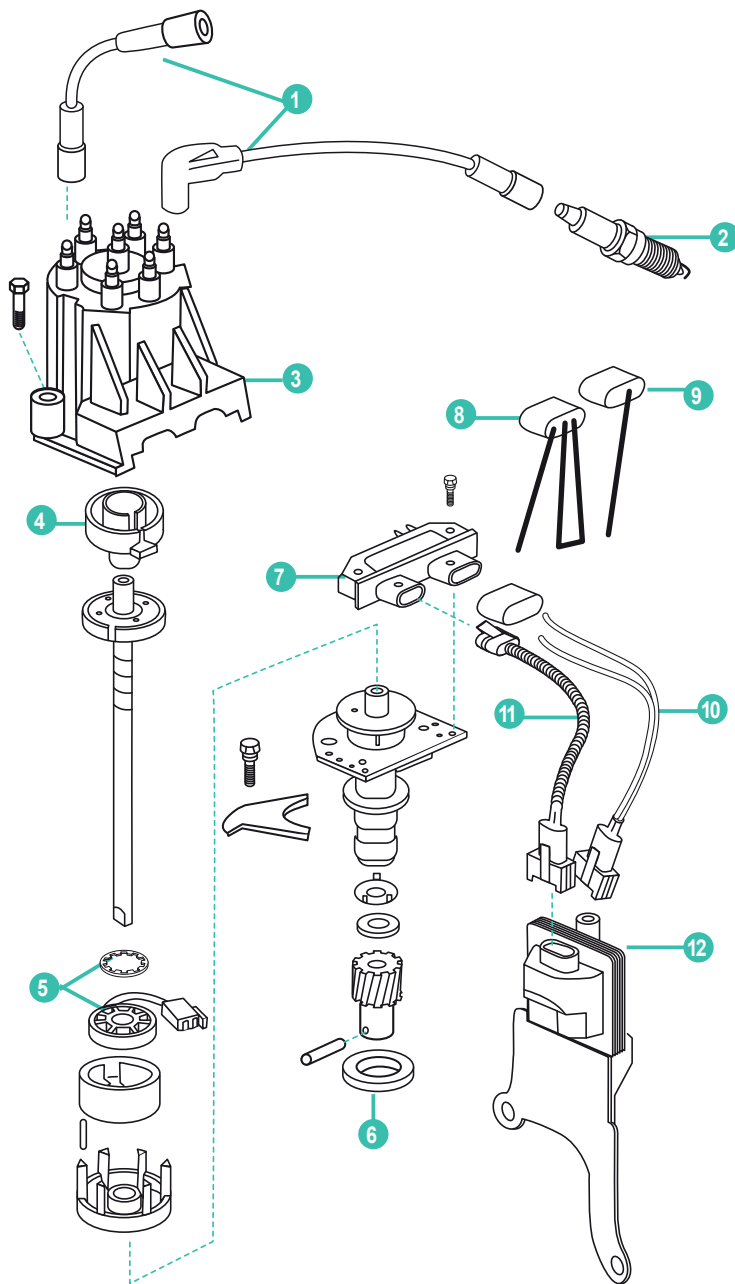

REF	VOLVO	MERCURUISER				UN.		
1	 3854084	 84-817386T01	CABLE ARRANQUE: SET V6	IGNITION WIRE: SET V6	CAVO INNIETIONE: SET V6	FAISCEAU DE BOUGIE	7	
2	 3854003	 91-888863	BUJÍAS	SPARK PLUGS	CANDELE	BOUGIES	6	
3	REC3854331	3854331	850484T2	TAPA: V6 DIST	CAP: V6 DIST	COPERCHIO: V6 DIST	TÊTE DE DISTRIBUTEUR: V6	1
4	REC3854311	3854311	8M0062084	ROTOR: V6 DIST	ROTOR: V6 DIST	ROTORE: V6 DIST	DOIGT D'ALLUMEUR: V6 DIST	1
5	REC3854001	3854001	811639T	MÓDULO	MODUL	MODULO	MODULE	1
6	REC27-344861	3852109	27-344861	JUNTA	GASKET	GUARNIZIONE	JOINT	1
7	REC3854003	3854003	91-888863	MÓDULO: DELCO DISTRIBUIDOR	MODULE: DELCO DIST	MODULO: DELCO DISTRIBUZIONE	MODULE ALLUMEUR DELCO	1
8	REC91-888863			HERRAMIENTA	TOOL: TIMING	STRUMENTO	OUTIL	1
9	REC294005			CABLE IGNICIÓN: INTERRUPTOR	IGNITION WIRE: SHIFT INTERRUPTER	CAVO ACCENSIONE: INTERRUPTORE	FAISCEAU POUR SHIFT INTERRUPTEUR	1
10	REC500442			CABLE ALIMENTACIÓN BOBINA	WIRE LEAD: COIL	CAVO: BOBINA	FAISCEAU POUR BOBINE	1
11	REC84-817376T01	3854084	84-817376T01	CABLES DE LA BOBINA A DISTRIBUIDOR	WIRE LEAD: COIL HARNESS TO DISTRIBUTOR	CAVI BOBINA A DISTRIBUZIONE	FAISCEAU POUR BOBINE	1
12	REC3854002	3854002	811637001	BOBINA: DELCO	COIL: DELCO E.I.	BOBINA: DELCO	BOBINE D'ALLUMAGE HEI	1
13	REC807964A1		807964A1	DISTRIBUIDOR: 262 (3, 4 y 7 incluidos)	DISTRIBUTOR: 262 (3, 4 & 7 Included)	DISTRIBUZIONE: 262 (3, 4 e 7 Compresi)	DISTRIBUTEUR: 262 (3, 4 e 7 inclus)	1

V8 BLOQUE PEQUEÑO V8 SMALL BLOCK  
5.0 & 5.7L

V8 BLOCCO PICCOLO V8 BLOQUE PETIT  
5.0 & 5.7L

ÁRBOL DE LEVAS

CAMSHAFT

ALBERO A CAME

ARBRE À CAMES

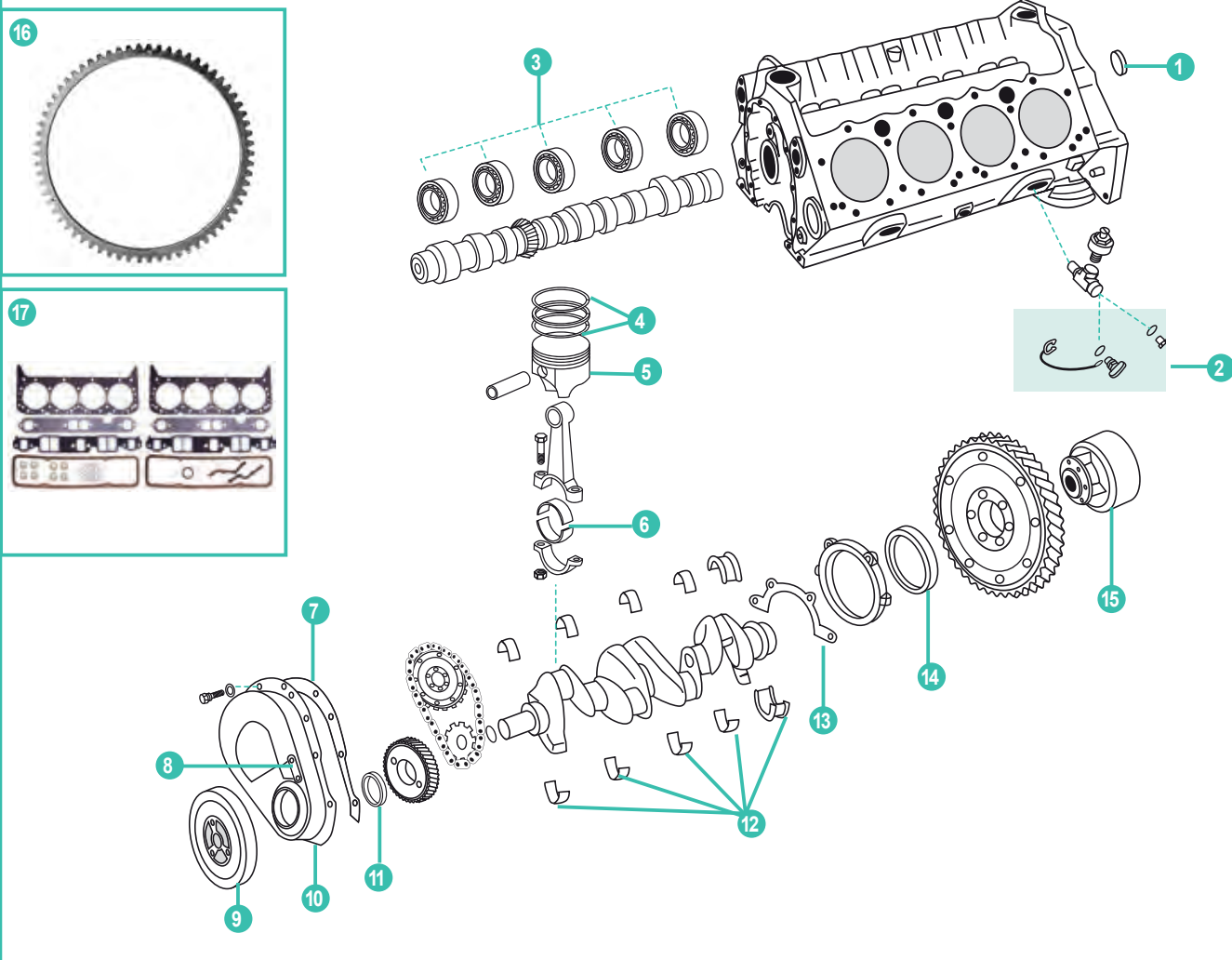

REF	VOLVO	MERCURUISER					UN.
1	MP0009-208	3853209 22-72640	TAPÓN DE EXPANSIÓN KIT DE LATÓN	BRASS EXPANSION PLUG KIT	TAPPO A ESPANSIONE KIT IN OTTONE	KIT PASTILLE DE SABLAGE	1
2	REC38201	21114522	RACORD DRENAJE COMPLETO	FULL FEETING	RACCORDO COMPLETO	RACCORD VIDANGE COMPLET	1
3	REC13014	3856162 23-85674	COJINETE ÁRBOL DE LEVAS	BEARING CAMSHAFT	CUSCINETTO ALBERO A CAME	ROULEMENT ARBRE A CAMES	2
			KIT AROS	RING SET	KIT ANELLI	KIT SEGMENTS	
	RM39-802559	3857670 39-802559	5.0L STD 1998+	5.0L STD 1998+	5.0L STD 1998+	5.0L STD 1998+	
	REC11009	39-75609	5.0L STD (1976-97)	5.0L STD (1976-97)	5.0L STD (1976-97)	5.0L STD (1976-97)	
	REC11020		5.0L 0.20 (1976-97)	5.0L 0.20 (1976-97)	5.0L 0.20 (1976-97)	5.0L 0.20 (1976-97)	
	REC11010	826470 39-75981	5.0L 0.30 (1976-97)	5.0L 0.30 (1976-97)	5.0L 0.30 (1976-97)	5.0L 0.30 (1976-97)	
4	REC11004	21179959 39-801861	5.7L STD (1996+)	5.7L STD (1996+)	5.7L STD (1996+)	5.7L STD (1996+)	8
	REC11016	39-17465	5.7L STD 0.30 (1996+)	5.7L STD 0.30 (1996+)	5.7L STD 0.30 (1996+)	5.7L STD 0.30 (1996+)	
	REC11005	857240 39-801861	5.7L STD 71mm	5.7L STD 71mm	5.7L STD 71mm	5.7L STD 71mm	
	REC11006	3853961 39-17465	5.7L 0.30 71 mm	5.7L 0.30 71mm	5.7L 0.30 71 mm	5.7L 0.30 71 mm	
	REC11011		5.7L 0.40 71 mm	5.7L 0.40 71mm	5.7L 0.40 71 mm	5.7L 0.40 71 mm	
	REC11001	3853960 39-17464	5.7L STD 81 mm	5.7L STD 81mm	5.7L STD 81 mm	5.7L STD 81 mm	



REF	VOLVO	MERCURUISER					UN.
			PISTON	PISTON	PSTONE	PISTON	
RM735-802557T	3857667	735-802557T	5.0L STD (1998+)	5.0L STD (1998+)	5.0L STD (1998+)	5.0L STD (1998+)	
REC10015			5.0L 0.20 (1987-97)	5.0L 0.20 (1987-97)	5.0L 0.20 (1987-97)	5.0L 0.20 (1987-97)	
REC10009	826465	735-6370	5.0L (-1987)	5.0L (-1987)	5.0L (-1987)	5.0L (-1987)	
REC10010		735-6371	5.0L 0.30 (-1987)	5.0L 0.30 (-1987)	5.0L 0.30 (-1987)	5.0L 0.30 (-1987)	
5 REC10006	21179952	735-850097	5.7L (1996+) (aros: 1.5x1.95x3mm)	5.7L (1996+) (rings: 1.5x1.5x3mm)	5.7L (1996+) (anelli: 1.5x1.5x3mm)	5.7L (1996+) (seg: 1.5x1.5x3 mm)	8
REC10013		735-850098	5.7L 0.30 (1996+) (aros: 1.5x1.95x3mm)	5.7L 0.30 (1996+) (rings: 1.5x1.5x3mm)	5.7L 0.30 (1996+) (anelli: 1.5x1.5x3mm)	5.7L 0.30 (1996+) (seg: 1.5x1.5x3 mm)	
REC10004	3854219	735-850097	5.7L STD (-1995) (aros: 1.98x1.98x4.76mm)	5.7L STD (-1995) (rings: 1.98x1.98x4.76mm)	5.7L STD (-1995) (anelli: 1.98x1.98x4.76mm)	5.7L STD (-1995) (seg: 1.98x1.98x4.76 mm)	
REC10005	3854221	735-97151T	5.7L 0.30 (-1995) (aros: 1.98x1.98x4.76mm)	5.7L 0.30 (-1995) (rings: 1.98x1.98x4.76mm)	5.7L 0.30 (-1995) (anelli: 1.98x1.98x4.76mm)	5.7L 0.30 (-1995) (seg: 1.98x1.98x4.76 mm)	
REC10018			262/350 (-1995 0.40) (aros: 1.98x1.98x4.76mm)	262/350 (-1995 0.40) (rings: 1.98x1.98x4.76mm)	262/350 (-1995 0.40) (anelli: 1.98x1.98x4.76mm)	262/350 (-1995 0.40) (seg: 1.98x1.98x4.76 mm)	
			KIT COJIENTE DE BIELA	BEARING KIT: CONN ROD	KIT CUSCINETTO BIELLA	COUSSINETS DE BIELLE	
6 REC13001	3853149	23-85701	5.0 y 5.7	5.0 & 5.7	5.0 y 5.7	5.0 y 5.7	1
REC13002	3856117	23-85704	0.10 5.0 y 5.7 (0.25 mm)	0.10 5.0 & 5.7 (0.25 mm)	0.10 5.0 e 5.7 (0.25 mm)	0.10 5.0 et 5.7 (0.25 mm)	
REC13024	3853153	23-85705	0.20 5.0 y 5.7 (0.51 mm)	0.20 5.0 & 5.7 (0.51 mm)	0.20 5.0 e 5.7 (0.51 mm)	0.20 5.0 et 5.7 (0.51 mm)	
7 REC27-14250	3852654	27-14250	JUNTA TAPA DISTRIBUIDOR	GASKET TIMING COVER	GUARNIZIONE COPERCHIO DISTRIBUZIONE	JOINT DE CARTER DE DISTRIBUTION	1
8 MP0011-045	3853195	75435A1	INDICADOR DE DISTRIBUCION	INDICATOR TIMING	INDICATORE DISTRIBUZIONE	INDICATEUR CALAGE DE DISTRIBUTION	1
			AMORTIGUADOR COUPLEAL	DAMPER: COUPLEAL	AMMORTIZZATORE COUPLEALE	DAMPER	
9 MP0009-004LC	3854023	852946001	5.0L & 4.3 Ø170mm VORTEC	5.0L & 4.3 Ø170mm VORTEC	5.0L & 4.3 Ø170mm VORTEC	5.0L & 4.3 Ø170mm VORTEC	1
MP0007-004			350 & CA PREVORTEC Ø205 mm	350 & CA PREVORTEC Ø205mm	350 & CA PREVORTEC Ø205mm	350 & CA PREVORTEC Ø205mm	
			TAPA DISTRIBUIDOR	COVER TIMING	COPERCHIO DISTRIBUZIONE	CARTER DE DISTRIBUTION	
10 REC15251	3853194	14249A2	SB NR (metálica)	SB NR (metal)	SB NR (metallo)	SB NR (metal)	
MP804007		835005	(Plástico) (1996+) sin sensor	(Plastic) (1996+) Without sensor	(Plastica) (1996+) senza sensore	(Plastique) (1996+) sans senseur	1
REC15254	3862263	863396	(Plástico) (1996+) con sensor	(Plastic) (1996+) With Sensor	(Plastica) (1996+) con sensore	(Plastique) (1996+) avec senseur	
11 REC3853341	3853341	26-97335	RETÉN CIGÜEÑAL SB NR y OR	SEAL FRONT SB NR & OR	TENUTA FRONTALE SB NR e OR	JOINT SPI VILEBREQUIN SB NR ET OR	1
			KIT COJINETE CIGÜEÑAL	BEARING KIT: CRANKSHAFT	KIT CUSCINETTO ALBERO MOTORE	KIT ROULEMENT VILEBREQUIN	
REC13012		23-85698	NR	NR	NR	NR	
12 REC13015	3862360	23-818465	NR (1996+)	NR (1996+)	NR (1996+)	NR (1996+)	1
REC13013		23-818467	NR 0.10 (0.25 mm)	NR 0.10 (0.25 mm)	NR 0.10 (0.25 mm)	NR 0.10 (0.25 mm)	
REC13025		23-818468	NR 0.20 (0.51 mm)	NR 0.20 (0.51 mm)	NR 0.20 (0.51 mm)	NR 0.20 (0.51 mm)	
REC13016		23-818467	NR 0.10 (1996+) (0.25 mm)	NR 0.10 (1996+) (0.25 mm)	NR 0.10 (1996+) (0.25 mm)	NR 0.10 (1996+) (0.25 mm)	
13 REC27-14241	3852656	27-14241	JUNTA: CIGÜEÑAL RR	GASKET: CRANKSHAFT RR	GUARNIZIONE: ALBERO MOTORE RR	JOINT AR DE VILEBREQUIN RR	1
			RETÉN CIGÜEÑAL	CRANKSHAFT SEAL	PARAOILIO ALBERO MOTORE	JOINT AR DE VILEBREQUIN	
REC26-14240	3852657	26-14240	RR SB (1996+)	RR SB (1996+)	RR SB (1996+)	RR SB (1996+)	
14 FELBS40013	841240	26-814622	RR SB (2 p.)	RR SB (2 pcs.)	RR SB (2 peci)	RR SB (2 pièces)	1
RECBS40013							
FEL17725	3856926	26-15123	OR (2 p.)	OR (2 pcs.)	OR (2 peCl)	OR (2 pièces)	
15			 ACOPLE	DUMPLER	ACCOPIAMENTO		1
			CORONA DENTADA	GEAR RING	CORONA DENTATA	COURONNE VOLANT	
16 REC157-N			157 dientes Ø12"	157 Teeth Ø12"	157 denti Ø12"	157 dents Ø12"	1
REC1685	3853143		168 dientes Ø13 - 3/4"	168 Teeth Ø13-3/4"	168 denti Ø13 - 3/4"	168 dents Ø13 - 3/4"	
			KIT JUNTAS	GASKET KIT	KIT GUARNIZIONE	KIT JOINTS	
REC17220			5.0L (perímetro)	5.0L (perimeter)	5.0L (perimetro)	5.0L (périmètre)	
REC17224			5.0L (centro)	5.0L (center)	5.0L (centro)	5.0L (centre)	
17 REC17230			5.7L (perímetro)	5.7L (perimeter)	5.7L (perimetro)	5.7L (périmètre)	1
REC17214			5.7L (centro)	5.0L (center)	5.7L (centro)	5.7L (centre)	
REC17232			5.7L GENE+ VORTEC	5.7L GENE+ VORTEC	5.7L GENE+ VORTEC	5.7L GENE+ VORTEC	
18 MP514516	855283		POLEA DE LA BOMBA DE DOBLE RANURA Ø150 mm	DUAL GROOVE PUMP PULLEY Ø150 mm.	PULEGGIA POMPA, DOPPIA SCALANATURA Ø150 mm	POULIE POMPE DE BRASSAGE Ø150 mm	
19 MP514693	835407		POLEA DEL CIGÜEÑAL DE DOBLE RANURA	DUAL GROOVE CRANK PULLEY	PULEGGIA ALBERO MOTORE DE DOPPIO SLOT	POULIE DE VILEBREQUIN 2 GORGES	
20 REC807757T			POLEA SERPENTINA 3" OD MCM (Plástico)	SERPENTINE PULLEY 3" OD MCM (Plastic)	PULEGGIA SERPENTINA 3" OD MCM (Plastica)	POULIE COMPOSITE SERPENTINE 3" OD	
21 REC8M6500024	865598	8M6500024	POLEA	PULLEY	PULEGGIA	POULIE	

Agujeros en la tapa de balancín  
Holes in rocker cover  
Fori in copperchio di bilanciere  
Trous dans le cache-culbuteurs



CULATA

CYLINDER HEAD

TESTATA

CULASSE

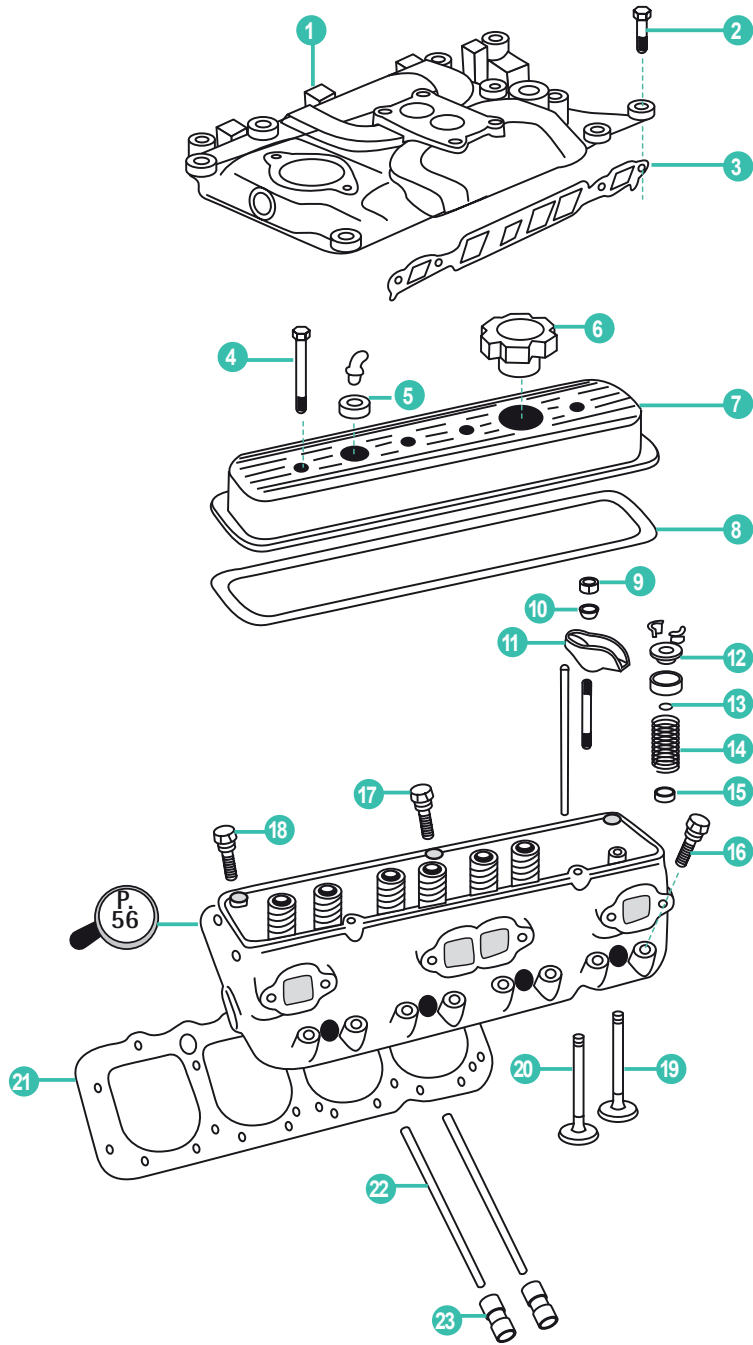

REF  
REC27-33395



	REF	VOLVO	MERCURISER				UN.	
1	REC425062	3856270	807289A1	COLECTOR: ADMISIÓN 5.7 VORTEC 4bb1	MANIFOLD: INTAKE 5.7 VORTEC 4bb1	COLLETTORE ASPIRAZIONE 5.7 VORTEC 4bb1	COLLECTEUR ADMIS.V8 5,7L VORTEC 4 CORPS	1
2	MP001204	940186	10-806681	TORNILLO COLECTOR ADMISIÓN	BOLT INTAKE MANIFOLD	VITE COLLETTORE ASPIRAZIONE	VIS DE CARTER D'ADMISSION	8
3	REC17320	856365	27-17145	KIT JUNTAS COLECTOR ADMISION	INTAKE MANIFOLD, GASKET KIT	KIT GUARNIZIONE COLLETTORE ASPIRAZIONE	KIT JOINTS COLLECTEUR ADMISSION	2
	REC27-807473A1	3857662	27-807473A1	PREVORTEC	PREVORTEC	PREVORTEC	PREVORTEC	
4	MP0009-107	3856135	10-17344	TORNILLO TAPA DE VÁLVULA SB	BOLT: VALVE COVER SB	VITE COPERCHIO VALVOLA SB	VIS DE CACHE CULBUTEUR	8
				ANILLO TAPA VÁLVULA	COVER VALVE, GROMMET	COPERCHIO VALVOLA, ANELLO	BAGUE CACHE CULBUTEUR	
5	REC6507			5.0 y 5.7L (1986+)	5.0 & 5.7L (1986+)	5.0 e 5.7L (1986+)	5.0 & 5.7L (1986+)	2
	RECTW9760	835415	8M0071559	5.0 y 5.7L (1978-85)	5.0 & 5.7L (1978-85)	5.0 e 5.7L (1978-85)	5.0 & 5.7L (1978-85)	
6	REC6532	3854008	36-18710002	TAPÓN ACEITE (1986+)	CAP: OIL FILL (1986+)	TAPPO: PARAOLIO (1986+)	BOUCHON D'HUILE (1986+)	1
	REC4804	3853840	17345	TAPÓN ACEITE (1978-85)	CAP: OIL FILL (1978-85)	TAPPO: PARAOLIO (1978-85)	BOUCHON D'HUILE (1978-85)	
				TAPA VÁLVULA	COVER VALVE	COPERCHIO VALVOLA	CACHE CULBUTEUR	
	REC14200	841212	79961T	5.0 y 5.7L (1987-88) (Agujeros laterales)	5.0 & 5.7L (1987-88) (Bolt around perimeter)	5.0 e 5.7L (1987-88) (Fori nel perimetro)	5.0 e 5.7L (1987-88) (Trous latéraux)	
7	REC14201	841212	79961T	5.0 y 5.7L (-1987) (Agujeros laterales)	5.0 & 5.7L (1987+) (Bolt around perimeter)	5.0 e 5.7L (1987+) (Fori nel perimetro)	5.0 e 5.7L (1987+) (Trous perimetraux)	1
	REC14202	3856928	809996	5.0 y 5.7L (1989+) (1 Tapón)	5.0 & 5.7L (1989+) (1 Seal)	5.0 e 5.7L (1989+) (1 tappo)	5.0 e 5.7L (1989+) (1 bouchon)	
	REC14203	3856928	809995	5.0 y 5.7L (1989+) (2 Tapones)	5.0 & 5.7L (1989+) (2 Seals)	5.0 e 5.7L (1989+) (2 tappi)	5.0 e 5.7L (1989+) (2 bouchons)	
				KIT JUNTAS TAPA VÁLVULA	GASKET KIT, VALVE COVER	KIT GUARNIZIONE COPERCHIO VALVOLA	KIT JOINTS CACHE CULBUTEUR	
8	REC17930	835096	27-52202	5.0 y 5.7L (-1986) (Agujeros laterales)	5.0 & 5.7L (1986+) (Bolt around perimeter)	5.0 e 5.7L (1986+) (Vite nel perimetro)	5.0 e 5.7L (-1986) (Trous latéraux)	1
	REC17931	3852687	27-17467	5.0 y 5.7L (1987+) (Agujeros centrales)	5.0 & 5.7L (-1987) (Central Bolts)	5.0 e 5.7L (-1987) (Vite nel centro)	5.0 y 5.7L (1987+) (Trous centrales)	
9	MP0007-122	3853004	11-34516	TUERCA: BRAZO BALANCÍN	NUT: VALVE ROCKER ARM	DADO: VALVOLA BILANCERE	ECROU DE CULBUTEUR	16
10	RM59340	3853198	59340	ROTOR: VÁLVULA	ROTATOR: VALVE	ROTORE: VALVOLA	COUPELLE POUR SOUPAPE ECHAPPEMENT	8
11	REC10352	3853158	35329	BALANCÍN: VÁLVULA	ROCKER ARM: VALVE	BILANCERE: VALVOLA	CULBUTEUR	16
12	MP0007-378	3853229	48348	TAPÓN: MUELLE VÁLVULA	CAP: INLET VALVE SPRING	TAPPO: MOLLA VALVOLA	COUPELLE RESSORT DE SOUPAPE	8
13	REC26-34217	3854956	26-34217	RETÉN ACEITE: VÁLVULA	SEAL: VALVE STEM OIL	PARAOLIO: VALVOLA	JOINT DE QUEUE DE SOUPAPE	16
14	RM24-483471	21605360	24-48347 1	MUELLE VÁLVULA (1996+)	SPRING: VALVE (1996+)	MOLLA VALVOLA (1996+)	RESSORT DE SOUPAPE (1996+)	16
15	REC70817B	3853226	26-97664	RETÉN: VÁLVULA ADMISIÓN	SEAL: INTAKE VALVE STEM	TENUTA: VALVOLA ASPIRAZIONE	JOINT DE QUEUE DE SOUPAPE	8
16	MP0007-029	3856124	10-11968	TORNILLO CORTO: CULATA	BOLT CYLINDER HEAD SHORT	VITE CORTA TESTATA	VIS COURTE CULASSE	16
17	MP0007-028	3856123	10-11967 1	TORNILLO MEDIO: CULATA	BOLT CYLINDER HEAD MED	VITE MEDIA TESTATA	VIS MOYEN CULASSE	4
18	MP0007-027	3856122	10-11966	TORNILLO LARGO: CULATA	BOLT CYLINDER HEAD LONG	VITE LUNGA TESTATA	VIS LONG CULASSE	14
				VÁLVULA ADMISIÓN	INTAKE VALVE	VALVOLA ASPIRAZIONE	SOUPAPE D'ADMISSION	
	REC13509			5.0L (47 -8,8 - 125) (2 ranuras)	5.0L (47 -8,8 - 125) (2 slots)	5.0L (47-8,8-125) (2 slot)	5.0L (47-8,8-125) (2 slot)	
19	REC13510	841873		5.7L (49 - 8,8 - 124) (2 ranuras)	5.7L (49 - 8,8 - 124) (2 slots)	5.7L (49-8,8-124) (2 slot)	5.7L (49-8,8-124) (2 slot)	8
	REC13507	3855810		5.7L VORTEC (1996+) (49-8,8-124) (1 ranura)	5.7L VORTEC (1996+) (49-8,8-124) (1 slot)	5.7L VORTEC (1996+) (49-8,8-124) (1 slot)	5.7L VORTEC (1996+) (49-8,8-124) (1 slot)	
	REC802555		802555	5.0L VORTEC 1996+ (46,5-8,7-124) (1 ranura)	5.0L VORTEC (1996+) (46,5-8,7-124) (1 slot)	5.0L VORTEC (1996+) (46,5-8,7-124) (1 Slot)	5.0L VORTEC (1996+) (46,5-8,7-124) (1 Slot)	
				VÁLVULA ESCAPE	EXHAUST VALVE	VALVOLA SCARICO	SOUPAPE D'ÉCHAPPEMENT	
	REC13502	856368	87284	5.0L (38 - 8,7 - 126) (2 ranuras)	5.0L (38 - 8,7 - 126) (2 slots)	V5.0 (38-8,7-126) (2 Slot)	V5.0 (38-8,7-126) (2 Slot)	
20	REC13508			V5.0L & 5.7L (38-9,4-125) (2 ranuras)	5.0L & 5.7L (38-9,4-125) (2 slots)	5.0 e 5.7L (38-9,4-125) (2 Slot)	5.0 e 5.7L (38-9,4-125) (2 Slot)	8
	REC13505	3855808		5.0L & 5.7L VORTEC (1996+) (38-8,7-125) (1 ranura)	5.0L & 5.7L VORTEC (1996+) (38-8,7-125) (1 slot)	5.0 e 5.7L VORTEC (1996+) (38-8,7-125) (1 Slot)	5.0 e 5.7L VORTEC (1996+) (38-8,7-125) (1 Slot)	
				JUNTA CULATA	CYLINDER HEAD GASKET	GUARNIZIONE TESTATA	JOINT DE CULASSE	
21	REC17020	3853380	27-75611	5.0L	5.0L	5.0L	5.0L	2
	REC17030	3853380	27-75611	5.7L	5.7L	5.7L	5.7L	
22	REC12000	3853157	99948	VÁRILLA VÁLVULA (-1986) 5.0 y 5.7L	ROD: VALVE (-1986) 5.0 & 5.7L	ASTA VALVOLA (-1986) 5.0 e 5.7L	TIGE DE CULBUTEUR (-1986) 5.0 & 5.7L	16
23	REC14002	3853954	17340T	EMPUJADOR VÁLVULA	LIFTER: VALVE	ALZA VALVOLA	POUSSOIR HYDRAULIQUE PLAT	16
	REC14001	3856127	72638	EMPUJADOR VÁLVULA (1996+) 5.0 y 5.7L	LIFTER: VALVE (1996+) 5.0 & 5.7L	ALZA VALVOLA (1996+) 5.0 e 5.7L	POUSSOIR HYDRAULIQUE PLAT (1996+) 5.0 et 5.7L	

CARBURACIÓN

CARBURATION

CARBURAZIONE

CARBURATION

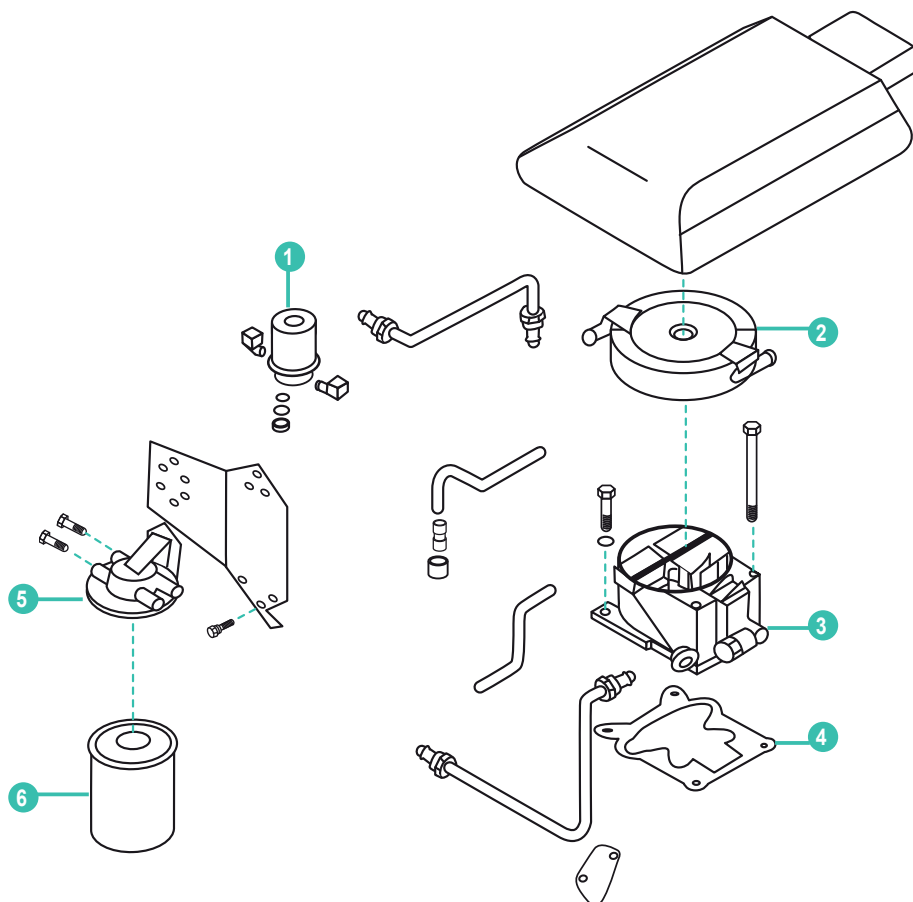

REF  
REC18-8114  
REC18-8115

REF	VOLVO	MERCUISER					UN.
1			BOMBA COMBUSTIBLE	FUEL PUMP	POMPA CARBURANTE	POMPE A CARBURANT	1
2	REC805298A1		PARALLAMAS 350	FLAME ARRESTOR: 350	ANTIFIAMMA 350	PARE FLAMME	1
3			CARBURADOR	CARBURETOR	CARBURATORE	CARBURATEUR	1
4			JUNTA CARBURADOR	GASKET: CARBURETOR	GUARNIZIONE CARBURATORE	JOINT CARBURATEUR	1
5	REC25000		BRACKET	BRACKET	BRACKET	SUPPORT	2
6			FILTRO COMBUSTIBLE (separador agua)	FILTER: FUEL/WATER SEP.	FILTRO CARBURANTE (separatore d'acqua)	FILTRE SEPARATEUR	1



**DISTRIBUIDOR**      **DISTRIBUTOR**      **DISTRIBUZIONE**      **DISTRIBUTEUR**

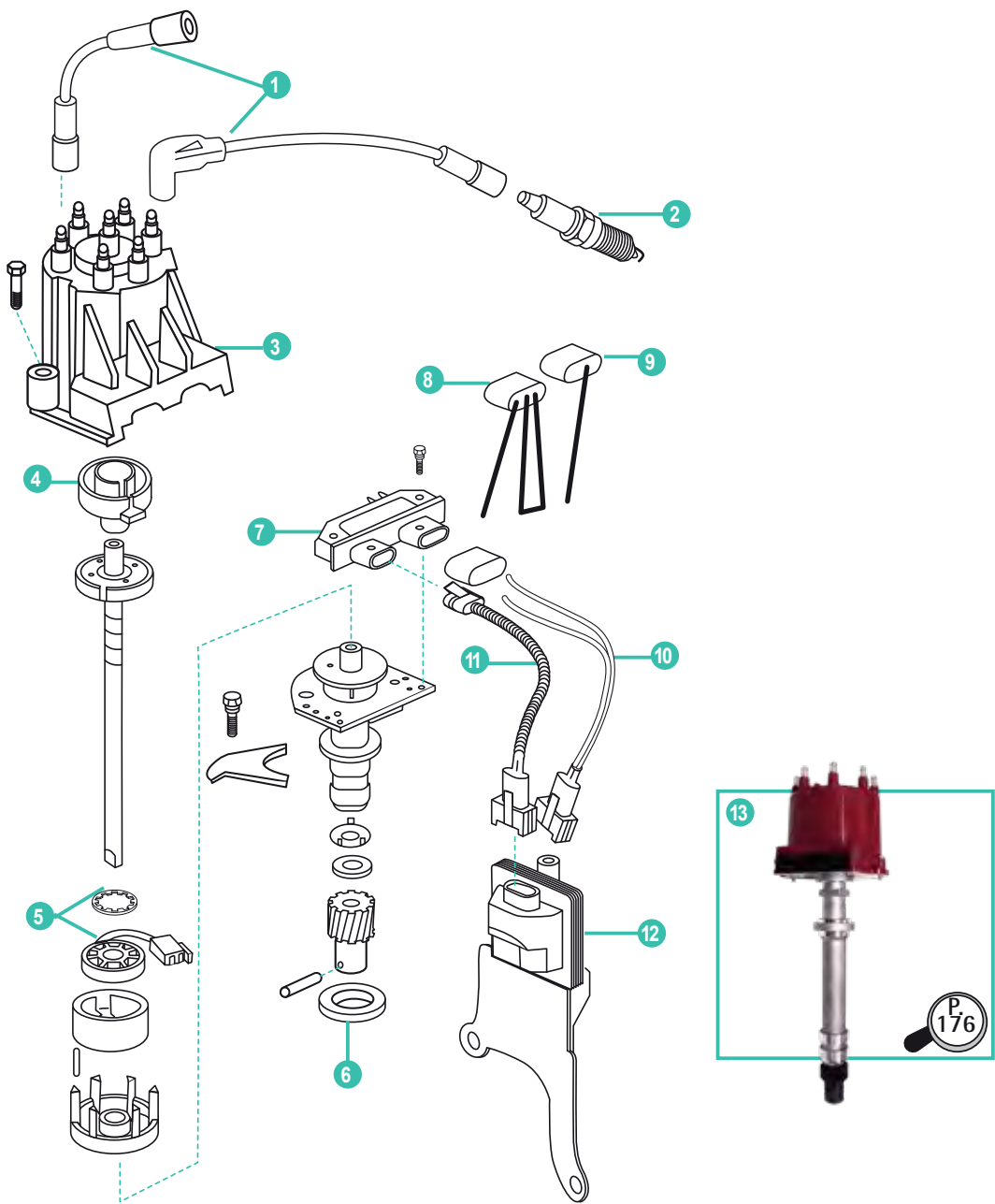

REF	VOLVO	MERCURISER				UN.	
<b>1</b>			KIT CABLE IGNICIÓN V8	IGNITION WIRE: SET V8	KIT CAVI INIEZIONE V8	KIT FAISCEAU DE BOUGIE	1
<b>2</b>			BUJÍAS: V8	SPARK PLUG: V8	CANDELE: V8	BOUGIE: V8	8
<b>3</b>	REC3854548	3854548 808483T3	TAPA: V8 DELCO E.I.	CAP: V8 DELCO E.I.	COPERCHIO V8 DELCO E.I.	TÊTE DE DELCO V8 E.I.	1
<b>4</b>	REC3854549	3862014 8M6001253	ROTOR V8 DELCO E.I.	ROTOR: V8 DELCO E.I.	ROTORE V8 DELCO E.I.	DOIGT D'ALLUMEUR	1
<b>5</b>	REC3854001	3854001 811639T	MÓDULO	MODULE	MODULO	MODULE	1
<b>6</b>	REC27-344861	3852109 27-344861	JUNTA	GASKET	GUARNIZIONE	JOINT	1
<b>7</b>	REC3854003	3854003 811637001	MÓDULO DELCO	MODULE: DELCO	MODULO DELCO	MODULE DELCO	1
<b>8</b>	REC91-888863	91-888863	HERRAMIENTA	TOOL: TIMING	STRUMENTO	OUTIL	1
<b>9</b>	REC294005		CABLE IGNICIÓN: INTERRUPTOR	IGNITION WIRE: SHIFT	CAVO INIEZIONE: INTERRUTTORE	FAISCEAU POUR SHIFT INTERRUPTEUR	1
<b>10</b>	REC500442		CABLES ALIMENTACIÓN BOBINA	WIRE LEAD: COIL DIST	CAVO BOBINA DISTRIBUZIONE	FAISCEAU POUR BOBINE	1
<b>11</b>	REC84-817376T01	3854084 84-817376T01	CABLES BOBINA A DISTRIBUIDOR	WIRE LEAD: COIL HARNESS	CAVI BOBINA A MODULO	FAISCEAU POUR BOBINE	1
<b>12</b>	REC3854002	3854002 898253T27	BOBINA: DELCO E.I.	COIL: DELCO E.I.	BOBINA DELCO E.I.	BOBINE D'ALLUMAGE HEI	
<b>13</b>	REC805222A1	3857449 805222A1	DISTRIBUIDOR V8 DELCO E.I. (3, 4 y 7 incluidos)	DISTRIBUTOR V8 DELCO E.I. (3, 4 & 7 included)	DISTRIBUTTORE V8 DELCO E.I. (3, 4 e 7 compresi)	DISTRIBUTEUR: V8 DELCO E.I. (3, 4 et 7 compris)	

V8 BLOQUE PEQUEÑO  
5.0, 5.7L & 6.2L

V8 SMALL BLOCK  
5.0, 5.7L & 6.2L

V8 BLOCCO PICCOLO  
5.0, 5.7L & 6.2L

V8 BLOQUE PETIT  
5.0, 5.7L & 6.2L

CARTER ACEITE

OIL PAN

COPPA OLIO

CARTER

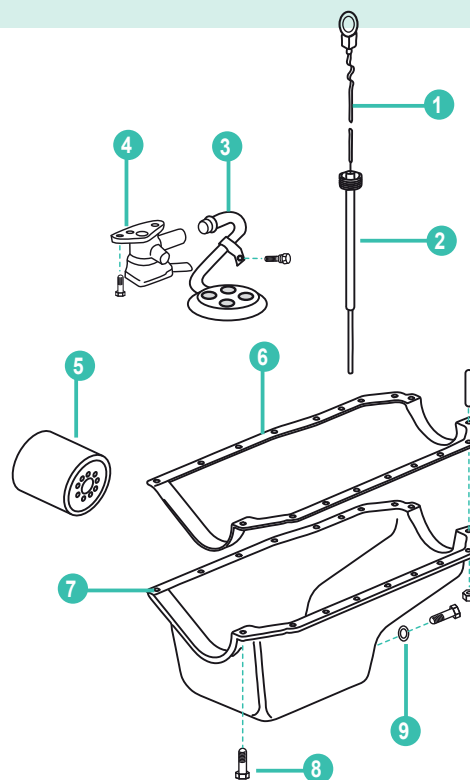

REF	VOLVO	MERCURUISER					UN.	
1	REC551455 MP371663	861942T2 861942T3	VARILLA ACEITE 5.0L, 5.7L 5.7V (1999+)	DIPSTICK 5.0L, 5.7L 5.7V (1999+)	ASTA LIVELLO DEL TUBO 5.0L, 5.7L 5.7V (1999+)	JAUGE D'HUILE 5.0L, 5.7L 5.7V (1999+)	1	
2	MP0307-002 MP373201	805384T	TUBO VARILLA ACEITE 5.0L, 5.7L PLASTISOLPAN SB	DIPSTICK TUBE 5.0L, 5.7L PLASTISOLPAN SB	ASTA LIVELLO DEL TUBO 5.0L, 5.7L PLASTISOLPAN SB	TUBE TIGE HUILE 5.0L, 5.7L PLASTISOLPAN SB	1	
3	MP0007-256	809908 1	FILTRO ACEITE (con tubo)	SCREEN OIL 350 (with tube)	FILTRO OLIO 350 (con tubo)	FILTRE A HUILE 350 (avec tuyau)	1	
4	REC14101	3853851 809907002	BOMBA ACEITE	PUMP OIL 350	POMPA OLIO 350	POMPE A HUILE 350	1	
5		 	FILTRO ACEITE V8	V8 OIL FILTER	FILTRO OLIO V8	FILTRE A HUILE V8	1	
6	REC17980 REC17981 REC17982 FEL17983	855729 855729 3856138 841240	27-52236 27-52236 27-13865 1 27-85917A1	JUNTAS CÁRTER 4 juntas varilla aceite babor 4 gaskets port 4 juntas varilla aceite estribor 4 gaskets stbd. 1 junta retén trasero 1 pieza 1 gasket 1 junta retén trasero 2 piezas 2 pieces rear seal	GUARNIZIONE COPPA OLIO 4 guarnizioni asta, livello babordo 4 guarnizione asta, livello tribordo 1 guarnizione 1 tenuta posteriore 1 guarnizione 2 tenute posteriore	JOINTS DE CARTER 4 joints de JAUGE D'HUILE Gauche 4 joints de JAUGE D'HUILE Droit 1 joint joint d'huile arrière 1 pièce 1 joint joint d'huile arrière 2 pièces	1	
7	REC15352 REC15353 REC809910	3857674 3850822 8809910	87758A1 13840A1 350 (-1986) 350 (1987+) 5.0, 5.7, 6.2 nuevo (MPI)	OIL PAN 350 (-1986) 350 (1987+) 5.0, 5.7, 6.2 new (MPI)	COPPA OLIO 350 (-1986) 350 (1987+) 5.0, 5.2, 6.2 nuovo (MPI)	CARTER 350 (-1986) 350 (1987+) 5.0, 5.2, 6.2 nouveau (MPI)	1	
8	RECPNRS-1100	940100	10-55715	KIT TORNILLOS	BOLTS KIT	KIT VITI	KIT VIS	1
9	REC27-49955	3851981	27-49955	JUNTA	GASKET	GUARNIZIONE	JOINT	1
10	REC17120 REC17125 FEL17124		KIT JUNTAS 4 juntas cárter 2 piezas retén 1 junta cárter 1 pieza retén 1 junta cárter 1 retén tapa distribución plástico	GASKET SET 4 oil pan gasket 2 pieces rear seal 1 oil pan gasket 1 piece rear seal 1 oil pan gasket 1 seal plastic dist.cap	KIT GUARNIZIONE 4 guarnizione coppa olio 2 tenute posteriori 1 guarnizione coppa olio 1 tenuta posteriori 1 guarnizione coppa olio 1 coperchio distribuzione in plastica	KIT JOINTS 4 joints de carter 2 pièces de joint spi 1 joint de carter 1 pièce de joint 1 joint de carter 1 joint CARTER DE DISTRIBUTION plastique	1	
11	MPI305-0380 MPI307-0380 MPI309-0380		MCM-OMC 1/2" VOLVO 3/4" FORD 14 mm	DRAIN HOSE MCM-OMC 1/2" VOLVO 3/4" Metric FORD 14 mm	TUBO DI SCARICO MCM-OMC 1/2" VOLVO 3/4" FORD 14 mm	TUYAU DE VIDANGE MCM-OMC 1/2" VOLVO 3/4" FORD 14 mm	1	

V8 BLOQUE GRANDE 7.4 & 5.8.2L    V8 BIG BLOCK 7.4 & 5.8.2L    V8 BLOCCO GRANDE 7.4 & 5.8.2L    V8 BLOQUE GRAND 7.4 & 5.8.2L

CARTER ACEITE    OIL PAN    COPPA OLIO    CARTER

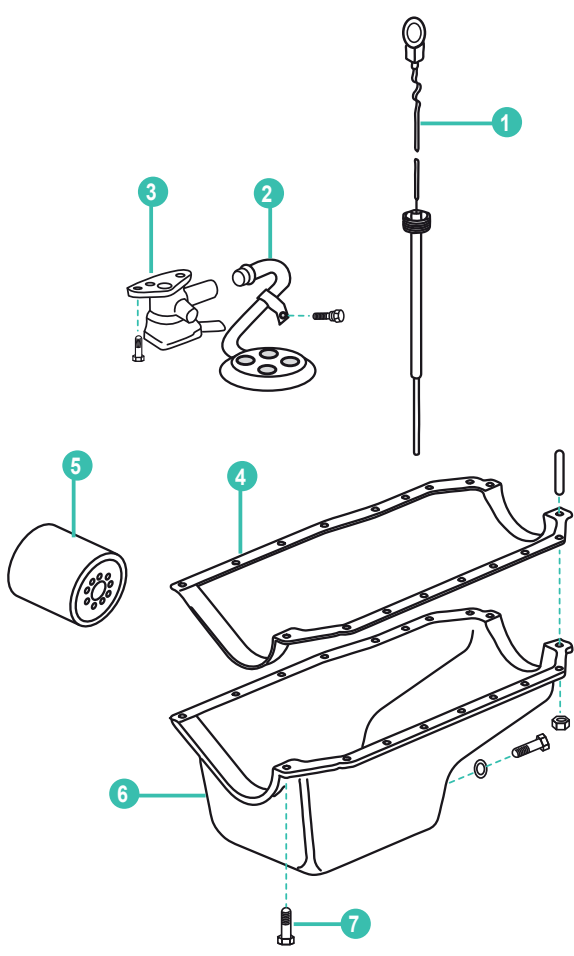
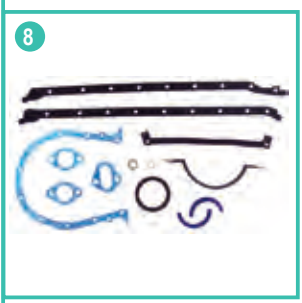

	7.4L	8.2L	VOLVO	MERCURUISER					UN.
1	MP0303-001	MP0303-001	856264	861942T9	VARILLA ACEITE: 454	DIPSTICK: 454	ASTA DI LIVELLO: 454	JAUGE D'HUILE	1
2					FILTRO BOMBA ACEITE	SCREEN: OIL PUMP	FILTRO POMPA OLIO	FILTRE POMPE A HUILE	1
3	REC14102		3855035	808693A1	BOMBA ACEITE: GENE IV	PUMP: OIL GENE IV	POMPA OLIO: GENE IV	POMPE A HUILE: GENE IV	1
	MP0053-255F8		3855035	827643	BOMBA ACEITE GENE V	PUMP: OIL GENE V	POMPA OLIO: GENE V	POMPE A HUILE: GENE V	1
4	REC17986	REC17986	3853510	27-845628	JUNTA: CÁRTER GEN V y VI	GASKET: OIL PAN GEN V & VI	GUARNIZIONE: COPPA OLIO, GEN V e VI	JOINT: CARTE GEN V et VI	1
	REC17985	REC17985	856889	27-52550	JUNTA: CÁRTER MKIV	GASKET: OIL PAN MKIV	GUARNIZIONE: COPPA OLIO, MKIV	JOINT DE CARTER MKIV	1
5					FILTRO ACEITE	OIL FILTER	FILTRO OLIO	FILTRE A HUILE	2
6	MP370039		3855990	845668T	CÁRTER 454 PLASTISOL GENE V	OIL PAN: 454 PLASTISOL GENE V	COPPA OLIO 454 PLASTISOL GENE V	CARTER 454 PLASTISOL GENE V	1
7	RECPNRS-1101	RECPNRS-1101			KIT TORNILLOS CÁRTER	BOLT OIL PAN KIT	KIT VITI COPPA OLIO	KIT VIS	1
	REC17140	REC17140		27-52550	KIT JUNTAS MKIV (4 juntas cárter 2 piezas retén)	GASKET SET MKIV (4 oil pan gaskets 2 rear seal)	KIT GUARNIZIONE MKIV (4 guarnizioni coppa olio 2 pezzi tenuta)	KIT JOINTS MKIV (4 joints carter 2 pièces joint)	1
8	FEL17145	FEL17145		27-811566	KIT JUNTAS GENE V (1 junta cárter 1 pieza retén)	GASKET SET GENE V (1 oil pan gasket 1 rear seal)	KIT GUARNIZIONE GENE V (1 guarnizione coppa olio 1 tenuta)	KIT JOINT GENE V (1 JOINT DE CARTER 1 pièce joint)	1
	REC17146	REC17146		27-845628	KIT JUNTAS GENE VI	GASKET SET GENE VI	KIT GUARNIZIONE GENE VI	KIT JOINTS GEN VI	1
					TUBO DE VACIADO MCM-OMC 1/2"	DRAIN HOSE MCM-OMC 1/2"	TUBO DI SCARICO MCM-OMC 1/2"	TUYAU D'ÉCHAPPEMENT MCM-OMC 1/2"	1
9					TUBO DE VACIADO VOLVO 3/4"	DRAIN HOSE VOLVO 3/4"	TUBO DI SCARICO VOLVO 3/4"	TUYAU D'ÉCHAPPEMENT VOLVO 3/4"	1
					TUBO DE VACIADO FORD 14 mm	DRAIN HOSE Metric FORD 14 mm	TUBO DI SCARICO FORD 14 mm	TUYAU D'ÉCHAPPEMENT FORD 14 mm	1

ÁRBOL DE LEVAS

CAMSHAFT

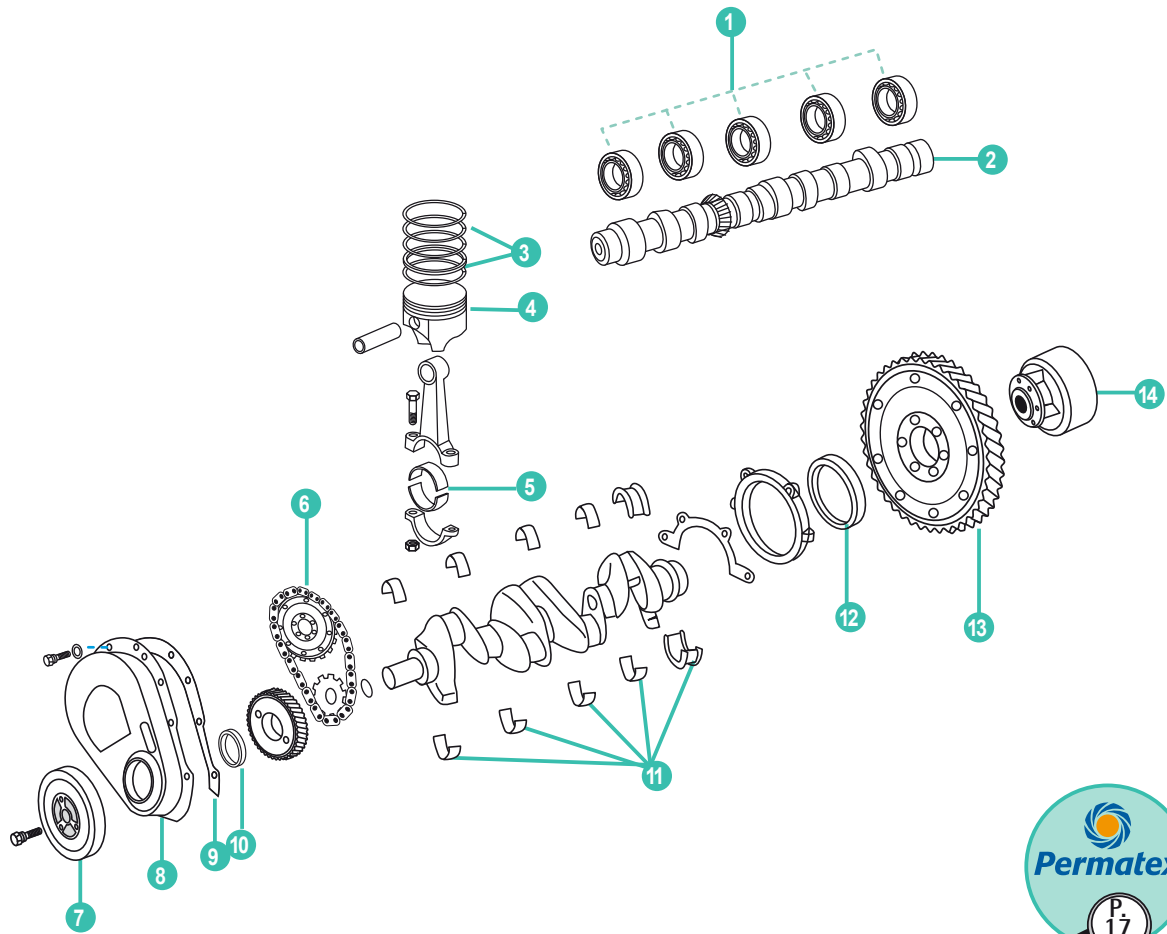

ALBERO A CAME

ARBRE À CAMES



	7.4L	8.2L	VOLVO	MERCUISER				UN.	
<b>1</b>	REC13017		23-85684		KIT COJINETE ÁRBOL DE LEVAS	BEARING KIT: CAMSHAFT	KIT CUSCINETTO ALBERO A CAME	KIT PALIER ARBRE À CAMES	1
	REC13017	REC13017	23-85684		MKIV	MKIV	MKIV	MKIV	
					GEN V		GENE V	GEN V	
<b>2</b>			3855034	431-4734	ÁRBOL DE LEVAS MKIV y GENE V	CAMSHAFT: MKIV & GENE V	ALBERO A CAME MKIV e GENE V	ARBRE À CAMES MKIV et GEN V	1
					KIT AROS	RING SET	KIT ANELLI	KIT SEGMENTS	
	REC11012		856591	39-67127	MKIV STD	MKIV Std	MKIV STD	MKIV STD	
	REC11019			39-67127	MKIV STD MAGNUM	MKIV Std Magnum	MKIV STD MAGNUM	MKIV STD MAGNUM	
	REC11013		856592	39-68128	MKIV 030	MKIV 030	MKIV 030	MKIV 030	
<b>3</b>	REC11018			39-67128	MKIV 030 MAGNUM	MKIV 030 Magnum	MKIV 030 MAGNUM	MKIV 030 MAGNUM	
	REC11014			39-827651T	GENE V y VI STD (Usar código GM 4XW, 5XW, 4XX, 5XX, 4XA, 5XA)	GENE V & VI Std (use code GM 4XW, 5XW, 4XX, 5XX, 4XA, 5XA)	GENE V e VI STD (utilizzare il codice GM 4XW, 5XW, 4XX, 5XX, 4XA, 5XA)	GEN V et VI STD (utiliser le code GM 4XW, 5XW, 4XX, 5XX, 4XA, 5XA)	
	REC11015			29-850447	GENE V y VI 030 (Usar código GM 4XW, 5XW, 4XX, 5XX, 4XA, 5XA)	GENE V & VI 030 (use code GM 4XW, 5XW, 4XX, 5XX, 4XA, 5XA)	GENE V e VI 030 (utilizzare il codice GM 4XW, 5XW, 4XX, 5XX, 4XA, 5XA)	GEN V e VI 030 (utiliser le code GM 4XW, 5XW, 4XX, 5XX, 4XA, 5XA)	



	7.4L	8.2L	VOLVO	MERCRUISER					UN.
					PISTON	PISTON	PISTON	PISTON	
4	REC10011		856589	737-879194035	MKIV STD	MKIV Std	MKIV STD	MKIV STD	8
	REC10012		856590	737-6615T 1	MKIV 030	MKIV 030	MKIV 030	MKIV 030	
					COJINETE BIELA	BEARING CONNECTING ROD	CUSCINETTO BIELLA	COUSSINETS DE BIELLE	
5	REC13019			23-85726001	GEN V	GEN V	GEN V	GEN V	8
	REC13018			23-85691	GEN V, GEN V 010 & MKIV 010	GEN V 010 & MKIV 010	GEN V 010 & MKIV 010	GEN V, GEN V 010 et MKIV 010	
					KIT CADENA DISTRIBUIDOR	KIT TIMING CHAIN	KIT CATENA DISTRIBUZIONE	KIT CHAINE DISTRIBUTION	
6	REC12504		856620	43-86481 + 86482 + 75588	MKIV	MKIV	MKIV	MKIV	1
	MP0053-084				7.4 GEN V	7.4 GEN V	7.4 GEN V	7.4 GEN V	
7	MP0053-004F8	MP0053-004F8	976644	811555	AMORTIGUADOR: COUPLEAL 454 NR	DAMPER: COUPLEAL 454 NR	AMMORTIZZATORE: COUPLEALE 454 NR	AMORTISSEUR DE VIBRATION: 454 NR	1
					TAPA DISTRIBUIDOR	COVER TIMING	COPERCHIO DISTRIBUZIONE	CARTER DE DISTRIBUTION	
8	REC15255	REC15255	856605	66215	454 MK IV	454 MK IV	454 MK IV	454 MK IV	1
	MP0053-060	MP0053-060		845610T	GENE V & VI NP (1996+) Junta silicona	GENE VI NP (1996+) Silicone Gasket	GENE VI NP (1996+) Guarnizione in silicone	GENE VI NP (1996+) Joint de silicone	
					JUNTA TAPA DISTRIBUIDOR	GASKET: TIMING COVER	GUARN. COPERCHIO DISTRIBUZIONE	JOINT CARTER DE DISTRIBUTION	
9	REC27-54529	REC27-54529	856608	27-54529	MKIV	MKIV	MKIV	MKIV	1
	REC27-850456			27-850456	GEN V & VI (silicona)	GEN V & VI (silicone)	GEN V & VI (in silicone)	GEN V et VI (silicone)	
10	REC26-8219471	REC26-8219471		26-8219471	RETÉN ACEITE: CIGÜEÑAL FRONTAL GENE IV, V, VI	SEAL: CRANKSHAFT OIL FRONT GENE IV, V, VI	PARAOLIO: ALBERO MOTORE FRONTALE GENE IV, V, VI	JOINT SPI CARTER DE DISTRIBUTION DAVANT GENE IV, V, VI	1
					KIT COJINETE CIGÜEÑAL	KIT BEARING CRANKSHAFT	KIT CUSCINETTO ALBERO MOTORE	KIT ROULEMENT VILEBREQUIN	
11	REC13020	REC13020		23-818473	MKIV, GENE V, GENE VI	MKIV, GENE V, GENE VI	MKIV, GENE V, GENE VI	MKIV, GEN V, GEN VI	1
	REC13021	REC13021		23-818476	MKIV, GENE V, GENE VI 010	MKIV, GENE V, GENE VI 010	MKIV, GENE V, GENE VI 010	MKIV, GEN V, GEN VI 010	
					RETÉN ACEITE CIGÜEÑAL	SEAL: CRANKSHFT OIL	PARAOLIO ALBERO MOTORE	JOINT SPI VILEBREQUIN	
12		REC26-811554		26-811554	TRASERO NR	REAR NR	POSTERIORE NR	ARRIÈRE NR	1
	REC26-14756	REC26-14756	856580	26-14756	454 MKIV	454 MKIV	454 MKIV	454 MKIV	
	FEL17740	FEL17740		26-75980	CONTRAROTACIÓN	OPPOSITE ROTATION	CONTROROTANTE	CONTRAROTATION	
13	MP0003-141				VOLANTE GEN V & VI 168 dientes	FLYWHEEL GEN V & VI 168 tooth	VOLANT GEN V & VI 168 denti	VOLANT GEN V & VI 168 dents	1
14					ACOPLE	DUMPLER	ACCOPPIAMENTO		1
									
15	MP514720	MP514720			POLEA DE CIGÜEÑAL DE DOBLE RANURA (Ø6-3/4")	DUAL GROOVE CRANKSHAFT PULLEY (Ø6-3/4")	PULEGGIA ALBERO MOTORE DE DOPPIO SLOT (Ø6-3/4")	POULIE VILEBREQUIN (Ø6-3/4")	1
16	REC807757T			807757T	POLEA SERPENTINA MCM (Plástico)	SERPENTINE PULLEY MCM (Plastic)	PULEGGIA SERPENTINA MCM (plastica)	POULIE COMPOSITE	1
	REC17240	REC17241			KIT JUNTAS	GASKET SET	KIT GUARNIZIONE	KIT JOINTS	
	REC17246				MKIV	MKIV	MKIV	MKIV	
	REC17242	REC17242			MKIV 385, 400, 420, 425HP	MKIV 385, 400, 420 & 425 HP	MKIV 385, 400, 420, 425 HP	MKIV 385, 400, 420, 425 HP	
	REC17242	REC17242			GENE V (sólo EFI)	GENE V (Only EFI)	GENE V (Solo EFI)	GEN V (Seul EFI)	
17	REC17242	REC17243			GENE V & VI (Excepto EFI)	GENE V & VI (Except EFI)	GENE V & VI (salvo EFI)	GEN V & VI (sauf EFI)	1
	REC17242	REC17243			GENE VI (Excepto EFI)	GENE VI (Except EFI)	GENE VI (salvo EFI)	GEN VI (sauf EFI)	
		REC17248			MKIV	MKIV	MKIV	MKIV	
		REC17248			GENE V	GENE V	GENE V	GEN V	
		FEL17249			GENE V EFI	GENE V EFI	GENE V EFI	GEN V EFI	
		REC17207			GENE V EFI	GENE V EFI	GENE V EFI	GEN V EFI	
		REC17207			GENE VI EFI	GENE VI EFI	GENE VI EFI	GEN VI EFI	
		REC17207			GENE VI EFI	GENE VI EFI	GENE VI EFI	GEN VI EFI	
					CORONA DENTADA	GEAR RING	CORONA DENTATA	COURONNE VOLANT	
18	REC157-N	REC157-N			157 dientes Ø12"	157 Teeth Ø12"	157 dente Ø12"	157 dents Ø12"	
	REC1685	REC1685			168 dientes Ø13-3/4"	168 Teeth Ø13-3/4"	168 dente Ø13-3/4"	168 dents Ø13-3/4"	

CULATA

CYLINDER HEAD

TESTATA

CULASSE

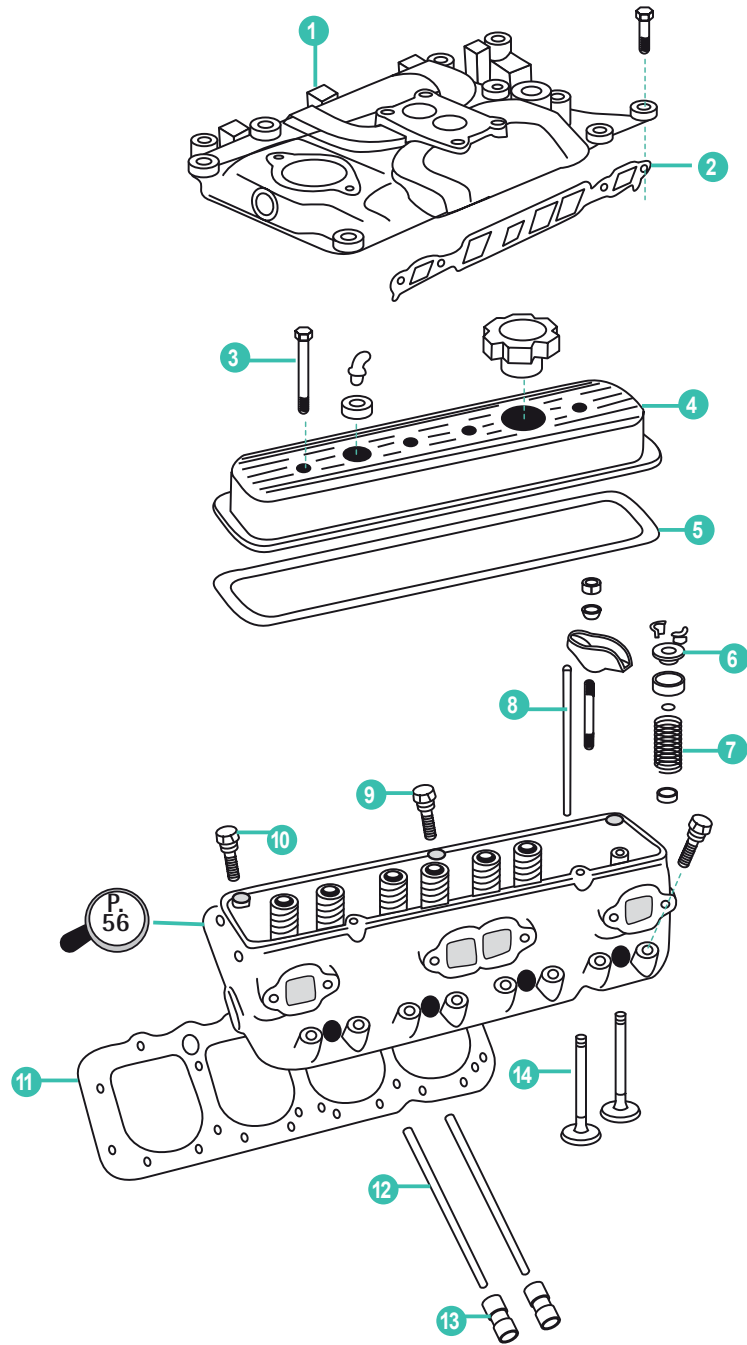

REF  
REC27-46820



	7.4L	8.2L	VOLVO	MERCURISER				UN.	
1	MP425113		3854100	811575T	COLECTOR ADMISIÓN: MKIV y GENE V	MANIFOLD INTAKE: MKIV & GENE V	COLLETTORE ASPIRAZIONE MKIV e GENE V	COLLECTEUR D'ADMISSION MKIV & GEN V	1
		MP425149		72608					
	REC17340		856616	27-65184	KIT JUNTAS COLECTOR ADMISION	GASKET KIT, MANIFOLD INTAKE	KIT COLLETTORE ASPIRAZIONE	KIT JOINTS COLLECTEUR ADMISSION	
2		REC17341		27-805722A1	MKIV, GEN V y VI	MKIV, GEN V & VI	MKIV, GEN V e VI	MKIV, GEN V e VI	2
	REC17342		3854095	27-8M0050225	GEN V y VI EFI (-1997)	GEN V & VI EFI (-1997)	GEN V e VI EFI (-1997)	GEN V e VI EFI (-1997)	
		REC17342		27-805403A1					
3	REC912127	REC912127		16-11995	TORNILLO: TAPA VÁLVULA	BOLT: VALVE COVER	VITE: COPERCHIO VALVOLA	VIS: CACHE CULBUTEUR	14
4	REC14204			17671	TAPA VÁLVULA: MKIV	VALVE COVER: MKIV	COPERCHIO VALVOLA: MKIV	CACHE CULBUTEUR: MKIV	2
					KIT JUNTAS TAPA VALVULA	GASKET KIT: VALVE COVER	KIT GUARNIZIONE COPERCHIO VALVOLA	KIT JOINTS CACHE CULBUTEUR	
5	REC17937	REC17937	3853513	27-811588	GENE V y VI	GENE V & VI	GENE V e VI	GEN V e VI	2
	REC17935	REC17935	856626	27-49121	MKIV	MKIV	MKIV	MKIV	
6					RETÉN ACEITE VÁLVULA ADMISION	SEAL: VALVE STEM OIL	PARAOILIO VALVOLA ASPIRAZIONE	JOINT SOUPE ADMISSION	
	REC26-75988	REC26-75988	3853521	26-75988	MKIV	MKIV	MKIV	MKIV	16
					MUELLE VÁLVULA	SPRING VALVE	MOLLA VALVOLA	RESSORT SOUPE	
7	REC11502		3854765	24-14754T	MKIV, GENE V	MKIV, GENE V	MKIV, GENE V	MKIV, GENE V	16
		RM24-801879		24-801879T					
	RM24-850465T		3853543		GENE VI (1996-98)	GENE VI (1996-98)	GENE VI (1996-98)	GEN VI (1996-98)	
8					EJE ÉMBOLO: VÁLVULA ESCAPE	PUSH ROD: EXHAUST VALVE	ASTA DI BIELLA: VALVOLA SCARICO	TIGE CULBUTEUR	
		REC12010		848262	MKIV (Ø8) GEN V	MKIV (Ø8) GEN V	MKIV (Ø8) GEN V	MKIV (Ø8) GEN V	6
9	MP0003-029	MP0003-029	3854767	10-8M0000483	TORNILLO CORTO CULATA	BOLT CYL HEAD SHORT	VITE CORTA TESTATA	VIS COURTE CULASSE	8
10	MP0003-027	MP0003-027	3854766	10-8M0000482	TORNILLO LARGO CULATA	BOLT CYL HEAD LONG	VITE LUNGA TESTATA	VIS LONGUE CULASSE	24
					JUNTA CULATA	GASKET: CYL HEAD	GUARNIZIONE TESTATA	JOINT DE CULASSE	
	REC17040		856575	27-8M0049045	MKIV	MKIV	MKIV	MKIV	
		FEL17049		27-811207					
	REC17042		3853511	27-879150141	GEN V y VI	GEN V & VI	GEN V e VI	GEN V e VI	
		REC17042		27-879150139					
11					385, 400, 420, 425 HP	385, 400, 420, 425 HP	MKIV 385, 400, 420, 425HP	MKIV 385, 400, 420, 425HP	2
	REC17046								
	REC17048		3853587	24-811546	MKIV, GENE V Y VI	MKIV, GENE V & VI	MKIV, GENE V e VI	MKIV, GEN V et VI	
	REC17048			27-811546	8.9L (525 y 950 HP)	8.9L (252 & 950 HP)	8.9L (252 e 950 HP)	8.9L (252 et 950 HP)	
	REC17048			27-811546	9.4L (750 HP)	9.4L (750 HP)	9.4L (750 HP)	9.4L (750 HP)	
12	REC12005	REC12006	3853483	848263	VARILLA VÁLVULA ADMISION	PUSH ROD: INTAKE VALVE	ASTICELLA VALVOLA ASPIRAZIONE	TIGE DE CULBUTEUR ADMISSION	8
					MKIV (Ø10)	MKIV (Ø10)	MKIV (Ø10)	MKIV (Ø10)	
		REC12010		848262	EJE ÉMBOLO: VÁLVULA ESCAPE MKIV (Ø8) GEN V	PUSH ROD: EXHAUST VALVE MKIV (Ø8) GEN V	ASTA DI BIELLA: VALVOLA SCARICO MKIV (Ø8) GEN V	TIGE CULBUTEUR ECHAPPEMENT MKIV (Ø8) GEN V	6
					ELEVADOR VÁLVULA	LIFTER VALVE	ALZA VALVOLA	POUSSOIR HYDRAULIQUE	
13	REC14000		3853954	72638	MKIV	MKIV	MKIV	MKIV	16
		RM811583		811583					
	REC14003	REC14003	3854099	811584	GENE V	GEN V	GENE V	GEN V	
					VÁLVULA ESCAPE	EXHAUST VALVE	VALVOLA SCARICO	SOUPE ECHAPPEMENT	
14	REC13513		856566	818962	MKIV, GENE V y VI (44-9,2-136) (1988-98) (1988-97) MKIV Y GENE V (48-9,3-136)	MKIV, GEN V & VI (44-9,2-136) (1988-98) (1988-97) MKIV & GENE V (48-9,3-136)	MKIV GENE V e VI (44-9,2-136) (1988-98) (1988-97) MKIV E GENE V (48-9,3-136)	MKIV GEN V et VI (44-9,2-136) (1988-98) (1988-97) MKIV et GEN V (48-9,3-136)	8
		RM816962	3853350	816962					

DISTRIBUIDOR      DISTRIBUTOR      DISTRIBUZIONE      DISTRIBUTEUR

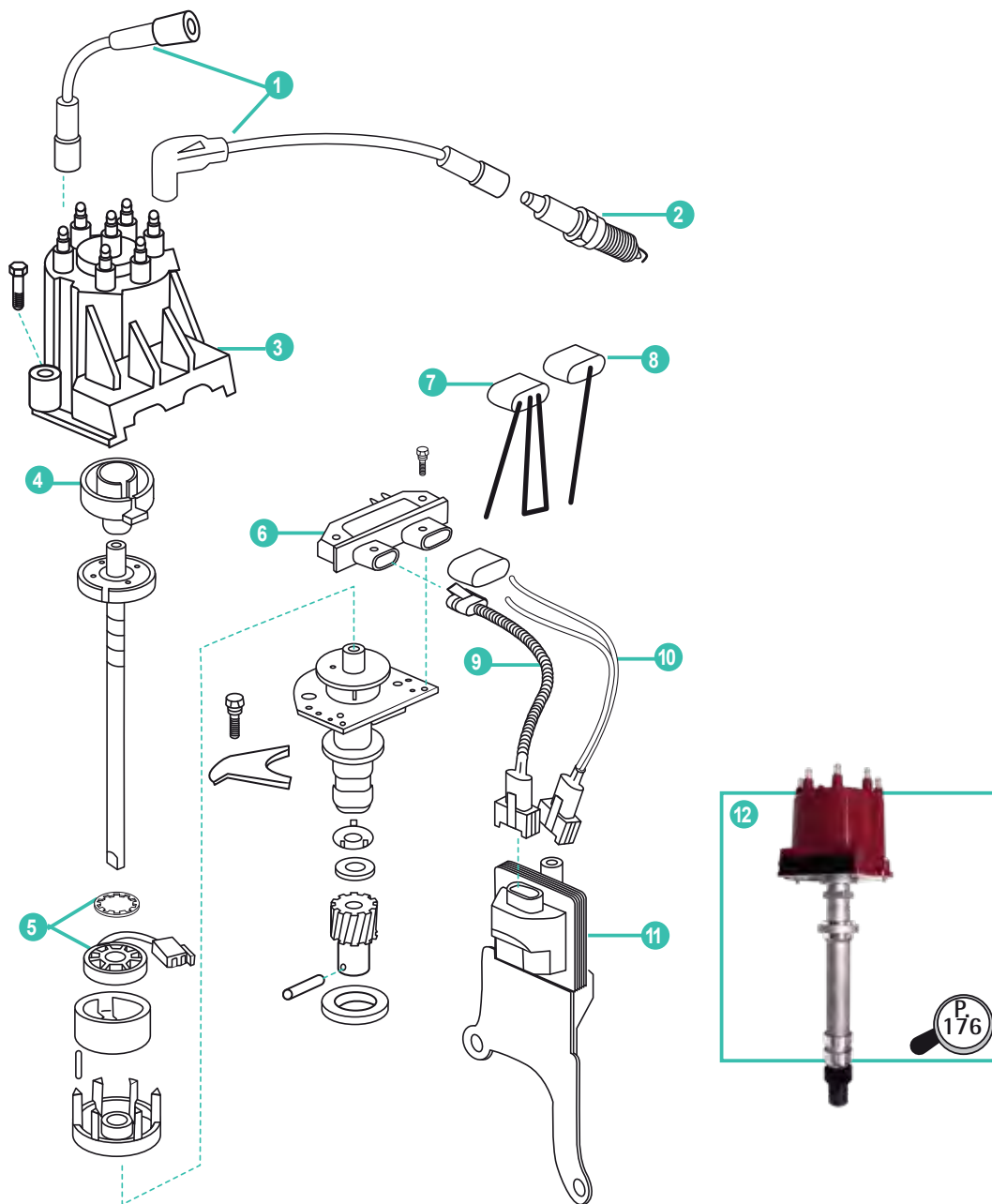

REF	VOLVO	MERCURUISER				UN.	
1			KIT CABLES ARRANQUE: V8	IGNITION WIRE SET: V8	KIT CAVI ACCENSIONE: V8	KIT FAISCEAU DE BOUGIE	1
2			BUJÍAS: V8	SPARK PLUG: V8	CANDELE: V8	BOUGIES	8
3	REC3854548		TAPA: DISTRIBUIDOR	CAP: DISTRIBUTOR	TAPPO DISTRIBUZIONE	TETE D'ALLUMEUR	1
4	REC3854549	3854084	ROTOR: DISTRIBUIDOR	ROTOR: DISTRIBUTOR	ROTORE: DISTRIBUZIONE	DOIGT D'ALLUMEUR	1
5	REC3854001	3854001 811639T	MÓDULO	MODULE	MODULO	MODULE	1
6	REC3854003	91-888863	MÓDULO DISTRIBUIDOR	MODULE: DISTRIBUTOR	MODULO: DISTRIBUZIONE	MODULE DISTRIBUTEUR	1
7	REC91-888863		HERRAMIENTA DISTRIBUIDOR	TOOL: TIMING	STRUMENTO: DISTRIBUZIONE	OUTIL POUR ALLUMEUR	1
8	REC294005	3857449 805222A1	CABLE: INTERRUPTOR	WIRE: SHIFT INTERRUPTER	CAVO: INTERRUPTORE	FAISCEAU POUR SHIFT INTERRUPTEUR	1
9	REC84-817376T01		CABLE: DISTRIBUIDOR - BOBINA	WIRE LEAD: DISTRIBUTOR - COIL	CAVI: DISTRIBUZIONE - BOBINA	FAISCEAU POUR BOBINE	1
10	REC500442		CABLE ALIMENTACIÓN BOBINA	WIRE LEAD: COIL HARNESS	CAVO: BOBINA	CÂBLE D'ALIMENTATION DE LA BOBINE	1
11	REC3854002	3854003 811637001	BOBINA ARRANQUE	COIL: IGNITION	BOBINA ACCENSIONE	BOBINE D'ALLUMAGE HEI	1
12	REC805222A1	3862014 8M6001253	DISTRIBUIDOR: DELCO V8 E.I. (3, 4 y 6 incluidos)	DISTRIBUTOR: DELCO V8 E.I. (3, 4 & 6 Included)	DISTRIBUZIONE: DELCO V8 E.I. (3, 4 e 6 compresi)	DISTRIBUTEUR: V8 DELCO E.I. (3, 4, et 6 inclus)	1



302 5.0L --> OMC 175 - 190  
351 5.8L --> OMC 235 - 240 - 250

MERCURISER 888 - 215 - 225  
MERCURISER 233 - 255

VOLVO AQ 190A  
VOLVO AQ 240A

## CULATA

## CYLINDER HEAD

## TESTATA

## BLOC MOTEUR

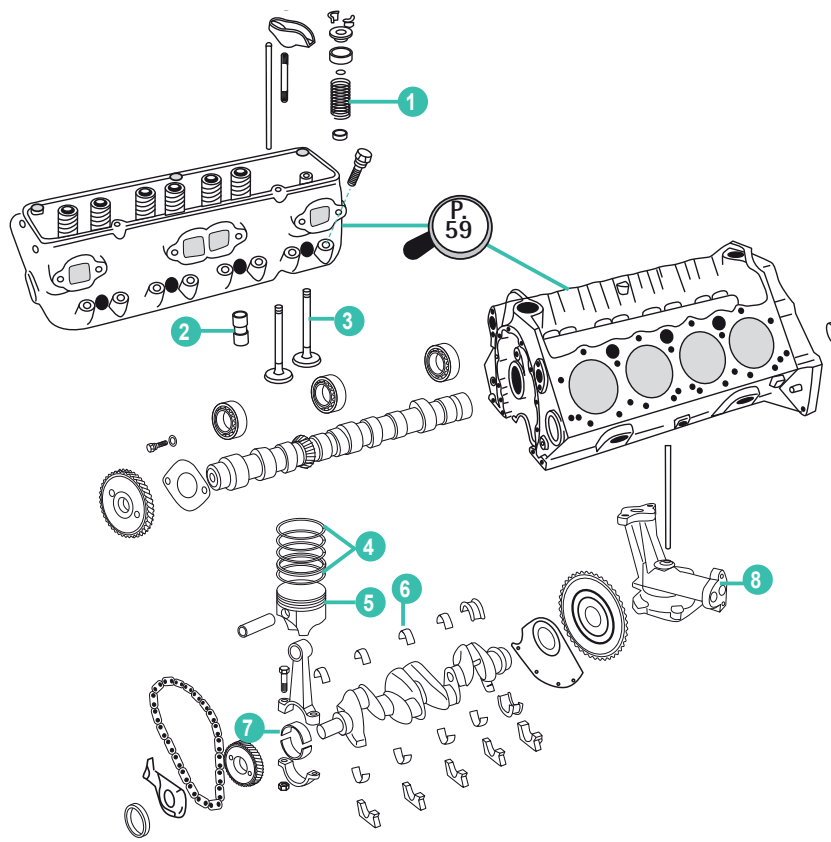

REF	VOLVO	MERCURISER				
			MUELLE ESCAPE	EXHAUST SPRING	MOLLA SCARICO	RESSORT DE SOUPE
<b>1</b>			5.0	5.0	5.0	5.0
REC24-75619		24-75619	5.8	5.8	5.8	5.8
			LIFTER	LIFTER	LIFTER	POUSOIR HYDRAULIQUE
<b>2</b>			5.0, 5.8 y 460	5.0, 5.8 et 460	5.0, 5.8 e 460	5.0, 5.8 e 460
REC3853847	3853847		5.0, 5.8 (1992-01)	5.0, 5.8 (1992-01)	5.0, 5.8 (1992-01)	5.0, 5.8 (1992-01)
			VALVULA DE ESCAPE	EXHAUST VALVE	VALVOLA SCARICO	SOUPE D'ECHAPPEMENT
<b>3</b>			5.0	5.0	5.0	5.0
REC3853731		56154	5.8	5.8	5.8	5.8
REC3853731	3853731	56154				
			AROS PISTÓN	PISTON RINGS	ANELLO PISTONE	SEGMENT
<b>4</b>			5.0 y 5.8	5.0 et 5.8	5.0 et 5.8	5.0 et 5.8
REC3853268	3853268	39-56114	030	030	030	030
FEDE-251K030						
REC3853885	3853885		040 (1995-00)	040 (1995-00)	040 (1995-00)	040 (1995-00)
			PISTON	PISTON	PISTONE	PISTON
<b>5</b>			5.0 (1987+)	5.0 (1987+)	5.0 (1987+)	5.0 (1987+)
REC3857022	3857022		5.0 A 030 (1987+)	5.0 030 (1987+)	5.0 030 (1987+)	5.0 030 (1987+)
REC3853898	3853898		5.0 (1977+)	5.0 (1977+)	5.0 (1977+)	5.0 (1977+)
			5.8 (1977+)	5.8 (-1977)	5.8 (-1977)	5.8 (-1977)
FED463P030			5.0 - 030 (1977+)	5.0 030 (1977+)	5.0 030 (1977+)	5.0 030 (1977+)
REC3857023	3857023		5.8 A 030 (1977+)	5.8 030 (-1977)	5.8 030 (-1977)	5.8 030 (-1977)
			5.0 - 040 (1995-00)	5.0 040 (1995-00)	5.0 040 (1995-00)	5.0 040 (1995-00)
			KIT COJINETES BANCADA	MAIN BEARING SET	KIT CUSCINETTO PRINCIPALE	KIT COUSSINET DE VILEBREQUIN
<b>6</b>			5.0	5.0	5.0	5.0
FED4125M			5.8	5.8	5.8	5.8
FED5078M			5.0 - 010	5.0 - 010	5.0 - 010	5.0 - 010
FED4125M010						
			COJINETES BIELA	BEARING CONNECTING ROD	CUSCINETTO BIELLA	COUSSINET DE BIELLE
<b>7</b>			5.0	5.0	5.0	5.0
REC3852775	3852775	23-56116	5.8	5.8	5.8	5.8
FED3380CPA		23-85744				
			BOMBA ACEITE	OIL PUMP	POMPA OLIO	POMPE A HUILE
<b>8</b>			5.0	5.0	5.0	5.0
REC3853909	3853909	56174	5.8	5.8	5.8	5.8
REC3850908	3853908	64787				

KITS DE JUNTAS			GASKET KIT			KIT GUARNIZIONE		KITS DE JOINTS	
5.0L			5.8L						
REF	VOLVO	MERCURUISER	REF	VOLVO	MERCURUISER				
FEL17060	3853732	27-75647	FEL17060	3853732	27-75647	JUNTA CULATA	HEAD GASKET	GUARNIZIONE TESTATA	JOINT DE CULASSE
FEL17260		27-64763A2	FEL17260		27-64763A2	KIT JUNTAS SUPERIOR	UPPER GASKET SET	KIT GUARNIZIONE SUPERIORE	KIT JOINTS SUPÉRIEUR
FEL17261			FEL17261			KIT JUNTAS CON TAPA VALVULAS ALUMINIO	GASKET SET ALUMINUM VALVE COVER	KIT GUARNIZIONE CON COPERCHIO VALVOLA ALLUMINIO	KIT JOINTS AVEC CACHE CULBUTEUR AL
FEL17161			FEL17166			KIT JUNTAS INFERIOR (1 Junta cárter, 1 retén trasero)	LOWER GASKET SET (1 oil pan gasket, 1 piece rear seal)	KIT GUARNIZIONE INFERIOR (1 guarn. coppa olio, 1 tenuta posteriore)	KIT JOINTS INFÉRIEUR (1 JOINT DE CARTER, 1 joint arrière)
FEL17160			FEL17165			KIT JUNTAS INFERIOR (4 Juntas cárter, retén trasero de 2 piezas)	Lower gasket set (4 oil pan gaskets, 2 pieces rear seal)	KIT GUARNIZIONE INFERIORE (4 guarn. coppa olio, 1 tenuta posteriore, 2 pezzi)	KIT JOINTS INFÉRIEUR (4 joints carter, joint arrière 2 pièces)
FEL17360	3853912	27-73042	FEL17360	3853912	27-73042	KIT JUNTAS COLECTOR ADMISION	INTAKE MANIFOLD GASKET SET	KIT GUARNIZIONE COLLETORE ASPIRAZIONE	KIT JOINTS COLLECTEUR D'ADMISSION
FEL17997	3852822		FEL17998	3852823		JUNTA CÁRTER (1pieza)	OIL PAN GASKET (1 piece)	GUARN. COPPA OLIO (1 pezzo)	JOINT DE CARTER (1 pièce)
FEL17995		27-64798	FEL17996		27-75483	JUNTA CÁRTER (4 piezas)	OIL PAN GASKET (4 pieces)	GUARN. COPPA OLIO (4 pezzi)	JOINT DE CARTER (4 pièces)
FEL17945		27-56173	FEL17945		27-56173	KIT JUNTAS TAPA VALVULAS	VALVE COVER GASKET SET	KIT GUARNIZIONE COPERCHIO VALVOLA	KIT JOINTS CACHE CULBUTEUR
FEL17946	3852818		FEL17946	3852818		KIT JUNTAS TAPA VALVULAS ALUMINIO	ALUMINUM VALVE COVER GASKET SET	KIT GUARNIZIONE COPERCHIO VALVOLA ALLUMINIO	KIT JOINTS CACHE CULBUTEUR AL
FEL17746		26-56869				RETÉN TRASERO CIGUENAL CONTRARROTACIÓN	CRANKSHAFT REAR SEAL OPPOSITE ROTATION	TENUTA POSTERIORE ALBERO MOTORE CONTROROTANTE	JOINT ARRIÈRE VILEBREQUIN CONTRE ROTATION

# REF --> RO / OEM

REF	OEM	VOLVO	MERCURUISER	PAG.
<b>B</b>				
BA50-090-075	22-33198A1			45
BRA125-1/2X1/2				45
BRA125-1/2X3/4				45
BRA125-1/2X3/8				45
BRA125-1/4X1/2				45
BRA125-1/4X1/4				45
BRA125-1/4X3/8				45
BRA125-1X3/4				45
BRA125-3/16X1/4				45
BRA125-3/4X3/4				45
BRA125-3/8X1/2				45
BRA125-3/8X3/8				45
BRA125-5/16X3/8				45
BRA125-5/8X3/4				45
BRA125-5/8X3/8				45
<b>C</b>				
CRA902171				39
CRA902175				39
CRA904633				38
CRA921023				39
CRA935154				37
CRA944595				34
CRA946331				38
CRA952343				34
<b>F</b>				
FA90401				46
FA90412				46
FA90515				46
FA90519				46
FA90526				46
FED3380CPA		23-85744		89
FED4125M				89
FED4125M010				89
FED463P030				89
FED5078M				89
FED517P				89
FEDE-251K030				89
FEL17019		24-47453		64
FEL17049		27-811207		87
FEL17060	3853732	27-75647		90
FEL17119				65
FEL17124				82
FEL17145		27-811566		83
FEL17160				90
FEL17161				90
FEL17165				90
FEL17166				90
FEL17219				67
FEL17249				85
FEL17260		27-64763A2		90
FEL17261				90
FEL17319		27-46401		64
FEL17360	3853912	27-73042		90
FEL17725	3856926	26-15123		77
FEL17725		26-35313		77
FEL17740		26-75980		85
FEL17746		26-56869		90
FEL17925		27-49936		64
FEL17926		27-34209		67
FEL17945		27-56173		90
FEL17946	3852818			90
FEL17975		27-49949		65
FEL17983	841240	27-85917A1		82
FEL17995		27-64798		90
FEL17996		27-75483		90
FEL17997	3852822			90
FEL17998	3852823			90
FELB540013				77
FIRGM262LA				61
FIRGM262LGT				61
FIRGM262LIT				61
FIRGM262LJT				62
FIRGM305LCT				62
FIRGM305RB				62
FIRGM305RC				62
FIRGM350RBF				63
FIRGM454RB				63
FIRH6009				61
FIRH6010				61
FIRH6011				61
FIRH6023				63
FIRH6036				63
FIRH6064				60
FIRH6065				60

REF	OEM	VOLVO	MERCURUISER	PAG.
<b>G</b>				
GE15210				14
GE21204				14
GE22001				13
GE22207				15
GE22254				15
GEGC15				14
GS11150				48
GS11151				49
GS11152				49
GS11153				49
GS11154				49
GS11155				49
GS11156				49
GS11157				49
GS11158				49
GS11159				49
GS20080				32
GS20081				32
GS20082				32
GS20084				33
GS20085				33
GS20151				33
GS20198				35
GS20199				35
GS30350				35
GS30351				35
GS30352				35
GS30353				35
GS31065				45
GS31066				45
GS31067				45
GS31155				45
GS31156				45
GS31157				45
GS31166				45
GS31245				45
GS35033				46
GS35034				46
GS35035				46
GS35036				46
GS35037				46
GS35038				46
GS35039				46
GS35040				46
GS35041				46
GS35042				46
GS35043				46
GS35044				46
GS35045				46
GS35046				46
GS35047				46
GS90001				12
GS90002				11
GS90003				11
GS90004				11
GS90005				11
GS90006				11
GS90007				11
GS90008				12
GS90009				12
GS90010				12
GS90011				12
GS90012				12
GS90013				12
GS90015				11
GS90019				11
GS90026				11
GS90029				11
GS90030				11
GS90031				11
GS90034				11
GS90037				11
GS90039				11
GS90040				11
GS90090				13
GS90092				13
GS90095				35
<b>L</b>				
LUB10212				30
LUB11363				29
LUB11400				29
LUB11402				29
LUB11552U12				25
LUB11957				33
LUB55011				30

REF	OEM	VOLVO	MERCURUISER	PAG.
<b>M</b>				
MP0003-027		3854766	10-8M0000482	87
MP0003-029		3854767	10-8M0000483	87
MP0003-141				85
MP0007-004				77
MP0007-027		3856122	10-11966	73-79
MP0007-028		3856123	10-11967/1	73-79
MP0007-029		3856124	10-11968	73-79
MP0007-122		3853004	11-34516	73-79
MP0007-256		3853197	809908 1	69-82
MP0007-378		3853229	48348	73-79
MP0009-002N5		3860214	860209A1	69
MP0009-004LC		3854023	852946001	77
MP0009-004LC		3857474	809892T	71
MP0009-036		21179974	614-811839T02	71
MP0009-107		3856135	10-17344	73-79
MP0009-194LC		3854948	827150	73
MP0009-194LC		3854949	827149	73
MP0009-208		3853209	22-72640	71-76
MP0011-045		3853195	75435A1	71-77
MP001204		940186	10-806681	79
MP001204		3856765	10-835004	73
MP0014-100		3853784	851036T	64
MP0014-401		3853138	814702	67
MP0014-403		3853955	10-34470	67
MP0025-004		3852662	55045T	67
MP0053-004F8		976644	811555	85
MP0053-060			845610T	85
MP0053-084				85
MP0053-255F8		3855035	827643	83
MP0303-001		856264	861942T9	83
MP0307-002		856248	12117A5	69
MP0307-002			805384T	82
MP0314-002				65
MP370039		3855990	845668T	83
MP371663			861942T3	82
MP373201				82
MP425024		3855805	824324T	73
MP425036		3855806	824330T1	73
MP425113		3854100	811575T	87
MP425149			72608	87
MP426422		3854346		74
MP429415				74
MP429905				74
MP514516		855283		71-77
MP514693		835407	807730	71
MP514693		835407		77
MP514720				85
MP804007			835005	77
MPI305-0380		3854956	26-34217	65-69-82-83
MPI307-0380		3857898	24-35214	65-69-82-83
MPI309-0380				69-82-83
<b>N</b>				
NGKBPR6EFS		3851857	816336Q	52-53-54-55-56-57
NGKBR6FS		3851861	33-59571B	54-55
<b>P</b>				
PER12063				19
PER12073				19
PER17762				18
PER35124				17
PER35134				17
PER35144				17
PER35375				18
PER35395				18
PER35572				19
PER35580				19
PER35611				18
PER35621				18
PER54283				17
PER54291				17
PER54292				17
PS111028				10
PS111035				10
PS111044				10
PS111047				10
PS111091				10
PS114699				10
PS114700				10
PS114701				10
PS114704				10
PS114709				10
PS4688				11
PS4706				11
PS4707				11

REF	OEM	VOLVO	MERCURUISER	PAG.
<b>R</b>				
RAC1/2X20				45
REC004				36
REC095009			220-801873	67
REC10001			733-803850T	67
REC10004		3854219	735-850097	71-77
REC10005		3854221	735-850098	71
REC10005		3854221	735-9715T1	77
REC10006		21179952	735-835001T	71
REC10006		21179952	735-850097	77
REC10009		826465	735-6370	77
REC10010			735-6371	77
REC10011		856589	737-879194035	85
REC10012		856590	737-6615T 1	85
REC10013			735-850098	71-77
REC10015				77
REC10018				71-77
REC10352		3853158	35329	73-79
REC10501		3857900	10-34510	64
REC10W30205L				22
REC10W3020L				22
REC10W3050L				22
REC10W30U3				22
REC10W30U6				22
REC10W40205L				22
REC10W4020L				22
REC10W4050L				22
REC10W40U3				22
REC10W40U6				22
REC11001		3853960	39-17464	67-71-76
REC11002			39-67132	67
REC11003			39-67134	67
REC11004		21179959	39-801861/1	71-76
REC11005		857240	39-801861	76
REC11005		3853960	39-17464	71
REC11006		3853961	39-17465	71-76
REC11008			39-66217	67
REC11009			39-75609	76
REC11010		826470	39-75981	76
REC11011				71-76
REC11012		856591	39-67127	84
REC11013		856592	39-68128	84
REC11014			39-827651T	84
REC11015			29-850447	84
REC11016			39-17465	71-76
REC11018			39-67128	84
REC11019			39-67127	84
REC11020				76
REC11021				67
REC11-13436		11-82670911		45
REC11-34933		11-34933		45
REC11502		3854765	24-14754T	87
REC11-52707Q1		11-52707Q1		45
REC1161995		1161995		28
REC11-8267089		11-35888		45
REC11-862903		11-82671013		45
REC12				8
REC12000		3853157	99948	73-79
REC12001		3857899	34532	64
REC12002		3853170	17739	73
REC12005		3853483	848263	87
REC12006		3853483	848263	87
REC12010			848262	87
REC12502			11985	71
REC12504		856620	43-86481 + 86482 + 75588	85
REC13001		3853149	23-85701	67-77
REC13002		3856117	23-85704	67-77
REC13003			23-85677	67
REC13004			23-85680	67
REC13005		3852829	23-43293T	67
REC13006		3856731	23-818469001	67
REC13007			23-818471	67
REC13008			23-85675	67
REC13009			23-85713	67
REC13010		21179992	23-11992001	71
REC13011			23-811858001	71
REC13012		3853215	23-818465	71
REC13012			23-85698	77
REC13013		856342	23-818467	71-77
REC13014		3856162	23-85674	71-76
REC13015		3862360	23-818465	77
REC13016			23-818467	77
REC13017			23-85684	84
REC13018			23-85691	85
REC13019			23-85726001	85
REC13020			23-818473	85



REF	OEM	VOLVO	MERCURISER	PAG.	REF	OEM	VOLVO	MERCURISER	PAG.
REC13021			23-818476	85	REC17341			27-805722A1	87
REC13024		3853153	23-85705	67-77	REC17342		3854095	27-8M0050225	87
REC13025			23-818468	77	REC17342			27-805403A1	87
REC13026			23-818472	67	REC17900				64
REC13501		3853127	52367	64	REC17903				67
REC13502		856368	85803	64-73	REC17920		3854300	27-11988	73
REC13502		856368	87284	79	REC17921		3854942	27-827154	73
REC13503			62421	64	REC17930		835096	27-52202	79
REC13504		3857879	97661	64	REC17931		3852687	27-17467	79
REC13505		3855808	824317 1	73-79	REC17935		856626	27-49121	87
REC13506		841873	97661	73	REC17937		3853513	27-811588	87
REC13507		3855810	809992	73-79	REC17950				65
REC13508				79	REC17970		855729	27-42797	69
REC13509				79	REC17971		3852655	27-883964T	69
REC13510		841873		79	REC17980		855729	27-52236	82
REC13513		856566	818962	87	REC17981		855729	27-52236	82
REC13514		3853139	34519	64	REC17982		3856138	27-13865 1	82
REC14000		3853954	72638	64-73-87	REC17985		856889	27-52550	83
REC14001		856397	17340T	73	REC17986		3853510	27-845628	83
REC14001		3855811	811844T	73	REC18				8
REC14001		3856127	72638	79	REC18-8114				74-80
REC14002		3853954	17340T	79	REC18-8115				74-80
REC14003		3854099	811584	87	REC19				8
REC14100		3853843	36405	65	REC20				8
REC14101		3853851	17617	69	REC21124849				71
REC14101		3853851	809907002	82	REC21124852	21124852			69
REC14102		3855035	808693A1	83	REC21180065		21180065		71
REC14200		841212	79961T	79	REC21363429	21363429			21
REC14201		841212	79961T	79	REC21363430	21363430			21
REC14202		3856928	809996	79	REC22-00842				45
REC14203		3856928	809995	79	REC22-00845				45
REC14204			17671	87	REC22-00874				45
REC15				8	REC22-05154				45
REC15251		3853194	14249A2	71-77	REC22-328022	22-32802			45
REC15252		3855735	809893	71	REC22-32803	M22-32803			45
REC15253		3859023	8M0069799	71	REC22-36382	22-36382			45
REC15254		3862263	863396	77	REC22479638	22479638			23
REC15255		856605	66215	85	REC22479642	22479642			23
REC15351		856386	14244T	69	REC22479648	22479648			24
REC15352		3857674	87758A1	82	REC22479650	22479650			24
REC15353		3850822	13840A1	82	REC22574246	22574246			25
REC15-405		3888324	84-816761Q14	68	REC24-75619		24-75619		89
REC157-N		3853143		67-71-77-85	REC25000				74-80
REC15W40205L				22	REC25W40205L				23
REC15W4020L				22	REC25W40U3				23
REC15W4050L				22	REC25W40U6				23
REC15W40U3				2	REC26-14240	3852657	26-14240		67-77
REC16				8	REC26-14240	3852657	26-8M0077606		71
REC1685		3853143		67-71-77-85	REC26-14756	856580	26-14756		85
REC17				8	REC26-34217	3854956	26-34217		64-73-79
REC17000				57	REC26-75988	3853521	26-75988		87
REC17000				64	REC26-811554		26-811554		85
REC17010		3854299	27-879150140	57-73	REC26-8219471		26-8219471		85
REC17020		3853380	27-75611	57-79	REC27-14241	3852656	27-14241		71-77
REC17030		3853380	27-75611	57-79	REC27-14241	3852656	27-881715		67
REC17040		856575	27-8M0049045	87	REC27-142471		27-142471		69
REC17042		3853511	27-879150141	87	REC27-14250	3852654	27-14250		71-77
REC17042			27-879150139	87	REC27-33395				54-55-56-78
REC17046				87	REC27-344861	3852109	27-344861		75-81
REC17048		3853587	24-811546	87	REC27-46820				57-86
REC17048			27-811546	87	REC27-49953	3852691	27-49953		67
REC17100				65	REC27-49955	3851981	27-49955		65-69-82
REC17102		3853343	27-810846	65	REC27-52546	27-52546			64
REC17110				69	REC27-53354				64
REC17116				69	REC27-54529	856608	27-54529		85
REC17120				82	REC27-807473A1	3857662	27-807473A1		54-55-56-79
REC17125				82	REC27-8146801				52
REC17140			27-52550	83	REC27-815528				52-64
REC17146			27-845628	83	REC27-850456		27-850456		85
REC17200				67	REC27-87707	3852660	27-87707		68
REC17207				85	REC27-96429				64
REC17210		857177	27-11977	71-73	REC27-99757				53-72
REC17211				71	REC294005	3857449	805222A1		88
REC17214				77	REC294005		807964A1		68
REC17220				77	REC2TU3				75-81
REC17224				77	REC2TU6				20
REC17230				77	REC3809445	3809445			20
REC17232				77	REC38201		21114522		26
REC17240				85	REC3850908		3853908	64787	71-76
REC17241				85	REC3852775		3852775	23-56116	89
REC17242				85	REC3853268		3853268	39-56114	89
REC17242				85	REC3853341		3853341	26-97335	89
REC17243				85	REC3853731		3853731	56154	67-71-77
REC17246				85	REC3853847		3853847		89
REC17248				85	REC3853885		3853885		89
REC17320				54-55-79	REC3853898		3853898		89
REC17340				57-87	REC3853909		3853909	56174	89

REF	OEM	VOLVO	MERCURISER	PAG.	REF	OEM	VOLVO	MERCURISER	PAG.
REC3854001		3854001	811639T	68-75-81-88	REC80W9020L				25
REC3854002		3854002	811637001	75	REC80W90U3				25
REC3854002		3854002	898253T27	68-81	REC80W90U6				25
REC3854002		3854003	811637001	88	REC817377			817377	68
REC3854003		3854003	811637001	68-81	REC824326002		3855807	27-824326002	53-73
REC3854003		3854003	91-888863	75-88	REC82745		MC22-87238		45
REC3854260		3854260	811635T3	68	REC82745		OMC379957		45
REC3854261		3854261	8M6001254	68	REC84-817376T01		3854084	84-817376T01	68-75-81-88
REC3854311		3854311	8M0062084	75	REC85122800		85122800		26
REC3854331		3854331	850484T2	75	REC859021		3856133	10-35366	71
REC3854548		3854548	808483T3	81-88	REC862210A01		MC862210A01		45
REC3854549		3854084		88	REC864297T01				71
REC3854549		3862014	8M6001253	81	REC879194401				53
REC3857022		3857022		89	REC888776T		3859022	888776T	71
REC3857023		3857023		89	REC8M0068784		3857532	8M0068784	46-67
REC3861911				56-57-61-62	REC8M0082988			8M0082988	67
REC3901775				42	REC8M6500024		865598	8M6500024	71-77
REC3902247				44	REC90095				36
REC3902250				44	REC91-00001				36
REC3902358				44	REC91-00002				36
REC3902407				44	REC91-00003				34
REC3902413				44	REC912127		3853503	10-65746	64
REC3902417				44	REC912127			16-11995	87
REC3902467				44	REC91-37241				36
REC3902659				43	REC91-859046Q3		91-859046Q3		37
REC3902864				44	REC91-859046Q4		91-821887T1		37
REC3902865				44	REC91-888863		885163	91-888863	68-75-81-88
REC3902907				44	REC936-810849		3854012	938-8M0115135	57-64
REC3902931				44	REC938-7499				58-62-63
REC3903008				44	REC938-803860T				58-63
REC3903502				44	REC938-8M0087884				58-62
REC3903560				44	REC97258A1				46
REC3904048				44	RECAGA00M1				42
REC3904277				43	RECATFU3				27
REC3905015				43	RECATFU6				27
REC3905159				43	REXAXONENEMO				42
REC3905265				44	REXAXONEVOICE				42
REC3905286				43	RECB540013		841240	26-814622	77
REC3905397				43	RECD06591				42
REC3906015				44	RECD127X0				42
REC3906219				43	RECED36				7
REC3906891				43	RECED36C				7
REC3907103				44	RECGM181				52
REC3907642				44	RECGM262VORTEC				53-62
REC3908405				44	RECGM305VORTEC				54-62
REC3909234				44	RECGM350				54-56-62
REC3910120				44	RECGM350MPI				56
REC3910127				43	RECGM350PREVORTEC				55-63
REC41400				46	RECGM350VORTEC				55-63
REC425062		3856270	807289A1	54-79	RECGM454				57-63
REC46-8M0113733				52	RECGM6.2MPI				56
REC46-8M0113734				54-55-56	RECGREU1				29
REC46-8M0113735				57	RECGREU12				29
REC4804		3853840	17345	79	RECH10				8
REC500442				68-75-81-88	RECH10-1/4				8
REC5119766				36	RECHANDLEJO6HD				9
REC5119902				36	RECISO46U3				27
REC5119903				36	RECISO46U6				27
REC55005				31	REJ010				9
REC55006				31	REJ06HD				9
REC55006				31	RECKFW				8-9
REC55133GF				31-32	RECKOCYL				9
REC55133M				31-32	RECKRW				9
REC55133S				31-32	RECMJ10PS				7
REC55134				38	RECNSCYL				8
REC551455			861942 17	69	RECPIN4				38
REC551455			861942T2	82	RECPIN4.5				38
REC5515100				35	RECPIN6				38
REC59341A1		3853135	59341A1	67	RECPNRS-1100		940100	10-55715	82
REC5W40205L				21	RECPNRS-1100		940135	14070	69
REC5W40U3				21	RECPNRS-1101				83
REC5W40U6				21	RECSRINGJO6HD				9
REC6507				79	RECSR9				10
REC6532		3854008	36-18710002	73-79	RECSR9WHEEL				10
REC70720				34	RECT11957				33
REC70817B		3853226	26-97664	73-79	RECT11958				33
REC75W140U3				25	RECT30190				31
REC75W90205L				24	RECT30201				30
REC75W9020L				24	RECTOOL1				10
REC75W90U3				24	RECTOOLTRIM1				38
REC75W90U6				24	RECTOOLTRIM2				38
REC802555			802555	79	RECTOOLTRIM3				38
REC805222A1		3857449	805222A1	81	RECTOOLTRIMKIT				38
REC805222A1		3862014	8M6001253	88	RECTW6502		3854945	14252	73
REC805298A1		3854026	805016A1	74-80	RECTW6502T		3854945	14251	73
REC807757T		3860201	807757T	71-77-85	RECTW9760		835415	8M0071559	73-79
REC807964A1			807964A1	75	RECWS3				9
REC809910			8809910	82	RECZ06590PC				42

REF	OEM	VOLVO	MERCUISER	PAG.
RM23-804982		3858954	23-804982	67
RM24-483471		21605360	24-48347 1	79
RM24-801879			24-801879T	87
RM24-850465T		3853543		87
RM26-879194364		3858698	26-879194364	71
RM39-802559		3857670	39-802559	76
RM59340		3853198	59340	64-73-79
RM733-810852		3853340	733-810852	67
RM735-802557T		3857667	735-802557T	77
RM804912T01		21124851	804912T01	69
RM809907002		3856125	809907002	69
RM809980T1		21124851	809980T1	69
RM810845		3854015	810845T	65
RM811583			811583	87
RM816962		3853350	816962	87
RM85108974	85108974			28
RM883494		3859021	883494	71
RM91-37299Q2				30
RM92-858021QB1U6	92-858021QB1			28
RM92-858022QB1U3	92-858022QB1			28
RM92-858023QB1U2	92-858023QB1			28
RM92-858026QB1U6	92-858026QB1			20
RM92-858027QB1U3	92-858027QB1			20
RM92-858037QB1U3	92-858037QB1			20
RM92-858064QB1U6	92-858064QB1			26
RM92-858065QB1U2	92-858065QB1			26
RM92-858074QB1U12				29
RM92-858084QE1U3	92-8M0096256			24
RM92-8M0086220U6	92-8M0086220			21
RM92-8M0086221U3	92-8M0086221			21
RM92-8M0086223U6	92-8M0086224			23
RM92-8M0086224U3	92-8M0086224			23
RM92-8M0086226U6	92-8M0086227			23
RM92-8M0086227U3	92-8M0086227			23
RM92-8M0096256U6	92-8M0096256			24
RM92-8M0096794U3	92-8M0096794			22
RM92-8M0121960U12	90-8M0121960			27
RM92-8M0133985U4				29
RM92-8M0133989U6				29
<b>S</b>				
SED4610100				12
SED4610101				12
SED4610102				12
SED4612902				12
SED4612903				12
SED4613002				12
SED4613003				12
SED4613102				12
SED4613103				12
SED4613125				12
SED4613402				12
SED4613403				12
SED4617101				12
SED4617201				12
SH3010-000				33
SH8050-305-426				32
SSP4206				37
SSP4207				37
SSP4213				37
SSP4600				33
SSPHBP100K				34
STA92600				13
STA93008				14
STA93016				14
STA93116				15
STA93664				15
STA93900				15
STA93922				15

REF	OEM	VOLVO	MERCUISER	PAG.
STA93932				15
STA94100				15
<b>T</b>				
TCMVRM5				41
TEC145				41
TEC218				40
TEC384				40
TEC786				40
TECDT8580				40
TRE1206MG				16
TRE1206MP				16
TRE1206MQ				16
TRE1212MG				16
TRE1245E				16
TRI202V-4004				48
TRI202V-5004				48
TRI202V-6004				48
TRI202V-8004				48
TRI252V0340-36				48
TRI252V1000-36				48
TRI252V1120-36				48
TRI252V1140-36				48
TRI252V1340-36				48
TRI260-4001				47
TRI260-4121				47
TRI260-5001				47
TRI260-6001				47
TRI270V-4000				47
TRI270V-4500				47
TRI270V-5000				47
TRI270V-6000				47
TRI290V-3000				47
TRI290V-4000				47
TRI290V-4500				47
TRI290V-5000				47
TRI290V-6000				47
TRI292V2000				47
TRI292V2120				47
<b>Y</b>				
YARCHA				10
YARES2				10
YARFHA				10

GUÍA IDENTIFICACIÓN DE MODELOS	102
GUÍA MANTENIMIENTO DE MOTORES	104
GUÍA MANTENIMIENTO TRANSMISIONES	108
KITS MANTENIMIENTO COLAS	108
MATERIALES GENÉRICOS PARA REVISIÓN	109

## SISTEMA ALIMENTACIÓN Y FILTRACIÓN 110

<b>GASOLINA</b>	
FILTRO DE ACEITE	114
PARA DIRECCIÓN HIDRÁULICA AXIUS	114
GUÍA	115
FILTRO DE AIRE	113
FILTRO DE COMBUSTIBLE Y ELEMENTOS	110
BRACKET	110
FILTRO DECANTADOR, VASO TRASPARENTE	111
FILTRO EN LÍNEA	112
FILTRO PARA CARBURADOR	113
FILTRO SEPARADOR AGUA	110
FILTRO VST	113
RACOR DE LATÓN	112

<b>DIESEL</b>	
FILTRO DE ACEITE	121
GUÍA	122
FILTRO DE AIRE	120
FILTRO DE COMBUSTIBLE Y ELEMENTOS	116
FILTRO CON CAZOLETA	117
FILTRO DECANTADOR	118
FILTRO TIPO SEPAR2000	120
FILTRO TRANSMISION HURT	121

ACCESORIOS PARA FILTROS	123
BOMBA DE COMBUSTIBLE	124
BOMBA DE ALTA PRESIÓN	126
BOMBA DE BAJA PRESIÓN	127
BOMBA MECÁNICA	124
BOMBA Y ENFRIADOR	129
GUÍA BOMBAS MECÁNICAS	125
JUNTAS	125
JUNTAS VST	129
MÓDULO DE COMBUSTIBLE COMPLETO	128
REGULADORES PRESIÓN COMBUSTIBLE	129
CARBURADOR	132
APAGALLAMAS	142
BOYAS	136
CARBURADOR NUEVO	133
CARBURADOR REMANUFACTURADO	132
CHOKE	142
GUÍA	140
GUÍA KITS	139
JUNTAS	137
KIT ADAPTADORES	135
KIT AGUJA	136
TORNILLOS	136
TUBO COMBUSTIBLE, BOMBA --> CARBURADOR	135
INYECTORES	130
KIT RETENES INYECTOR	131
RACORES	122
TURBO	143
ABRAZADERA ESCAPE	143
KIT JUNTAS	143
RETÉN ACEITE	143

## SISTEMA ELÉCTRICO 144

ALTERNADORES Y REGULADORES	153
KIT SUSTITUCIÓN ALTERNADOR	155
REGULADOR ALTERNADOR	155
MOTORES DE ARRANQUE	151
SENSORES	144
ÁRBOL DE LEVAS	146
CAUDAL DEL AGUA	148
GUÍA SENSORES	149
IAC	145
MAT/MAP	144
OXÍGENO	145
PICADO	145
PICK UP	145
POSICIÓN CIGÜEÑAL	146
PRESIÓN DE ACEITE	147
TEMPERATURA DEL AGUA	148
TEMPERATURA DE AIRE	148
TEMPERATURA ENFRIADOR	148

TEMPERATURA Y PRESIÓN ACEITE CON ALARMA	147
TPS	144
TRIM	146
VÁLVULA DE AIRE	145
SOLENOIDE, RELÉ Y FUSIBLES	157
ALARMA	160
EXTENSOR DE SOLENOIDE PARA TERMINALES	157
FUSIBLE ATM, ATC, MAXI	159
FUSIBLE MOTOR	158
FUSIBLE TERMINAL DE BATERÍA	159
FUSIBLE TRIM	158
INTERRUPTORES DE PARO	160
INTERRUPTORES TRIM	160
MERCATHODE	159
SOLENOIDES	157
SOLENOIDES ARRANQUE	157
SOLENOIDES DELCO REMY	157
SOLENOIDES TRIM	157
RELÉ	158
RELÉ DE ARRANQUE Y BOMBA GASOLINA	158
RELÉ PARA ACCELERADOR Y EJE	158
RELÉ PARA ALARMA Y VARIOS	158
TRIM	155
CONVERTIDOR DE 3 A 2 CABLES	156
DEPÓSITO	156
SOPORTE	156
TRIM COMPLETO	155

## SISTEMA ENCENDIDO 161

BOBINA ENCENDIDO	161
ENCENDIDO ELECTRÓNICO	161
BUJÍAS	163
CABLES ALTO RENDIMIENTO	167
DISTRIBUIDOR	168
CONDENSADORES	170
DESPIECES	173
• DELCO VOYAGER	173
• MPI V6 & V8	175
• THUNDERBOLT IV & V	174
DISTRIBUIDOR	175
DISTRIBUIDOR ELECTRÓNICO	176
GUÍA KITS DE CONVERSIÓN ELECTRÓNICO	172
GUÍA KITS DE ENCENDIDO	171
KITS DE CONVERSIÓN ELECTRÓNICO	172
KITS DE ENCENDIDO	170
PLATINOS	170
ROTORES	169
TAPA	168
TRIGGERS	169
MÓDULOS IGNICIÓN	162

## SISTEMA DE REFRIGERACIÓN 177

BOMBA DE AGUA	185
BOMBAS DE BRONCE	186
JUNTAS	187
CORREAS	194
GUÍA CORREAS MOTOR	198
GUÍA CORREAS SERPENTÍN	197
GUÍA DIESEL	195
GUÍA GAS	195
ENFRIADOR DE ACEITE	184
KITS BOTELLAS DE ACEITE	185
KITS ENFRIADOR	184
GUÍA DE IMPULSORES	188
INTERCAMBIADOR DE CALOR	183
KITS	183
KIT DE REPARACIÓN	189
1   R   MR   ALPHA ONE	189
ALPHA ONE GEN II	190
BRAVO I, II & III	191
DESPIECE	192
POLEA BOMBA	193
TENSOR CORREA V6 & V8	194
MANGUITOS MOTOR	198
BOMBA AGUA	199
BOMBA AGUA --> ENFRIADOR DE ACEITE	199
CUERPO TERMOSTATO -->	200
COLECTOR ESCAPE	200
CULATA --> COLECTOR ESCAPE	198
ENFRIADOR --> CUERPO TERMOSTATO	199
ENFRIADOR DE ACEITE	199
GUÍA MANGUITOS	202
GUÍA MANGUITOS DE COLA	201

GUÍA MANGUITOS EJE --> GASOLINA	203
TOMA AGUA	198
TRANSOM --> ENFRIADOR	199
TERMOSTATO	177
CASQUILLO	178
CONECTOR RÁPIDO	179
CUBIERTA	180
CUERPOS	177
EJE VÁLVULA	179
JUNTAS	180
KIT CUERPO DE TERMOSTATO	177
KITS TERMOSTATOS	181
MÓDULO DISTRIBUCIÓN	179
TERMOSTATOS DIESEL	181
VÁLVULA T	179

## PARTES DEL MOTOR 204

JUNTAS DISTRIBUCIÓN	215
JUNTAS TAPA	215
JUNTAS PARA BASES GM Y FORD	204
RETENES	215
GUÍA RETENS ACEITE	216
GUÍA RETENS CIGÜEÑAL	216
GUÍA TÓRICAS	215
JUNTAS MOTOR 4CYL LINEA	217
RETENES CIGÜEÑAL	216
RETENES VÁLVULAS	216
VÁLVULA ADMISIÓN	216

## SISTEMA ESCAPE Y ADMISIÓN 218

120 HP GM 153	218
CODO ESCAPE	218
COLECTOR ESCAPE	218
JUNTA CODO ESCAPE	218
JUNTA COLECTOR	218
JUNTA TAPA COLECTOR	218
TAPA COLECTOR	218
DESPIECES COLECTORES Y CODOS	219
140HP GM181	219
2.5L GM 153 4 cyl, 3.0L 4 cyl (1983-89)	220
3.0L/LX GM 181	222
3.0L MPI	223
165, 170, 180, 190, 470, 485, 488	224
3.7L/LX MCM 224 CID	225
GM 160, 165, 200CID, 250, 292CID	225
175, 185, 205, 262 MAG,	226
4.3L/LX/LH/LXH/EFI/MPI, GM 262 CID V6	226
4.3L CARB MPI ALPHA/BRAV	228
262 MAG (TBI), 4.3L/LH/LX/EFI (GEN+), GM 262 V6 (1996-01)	230
V6	231
305, 350, 377, 383, 385, (6.2L)	232
MAG MPI HORIZON ALPHA/BRAVO	232
V8 SMALL BLOCK	234
198MIE, 228/MIE & 898, GM305CID, V8 250, 255MIE & 260	235
200, 228, 230, 230 MIE, 5.0L/LX, 898, 5.0L MPI, GM305 CID, 260/MIE, 320 EFI, 350 MAG, GM350 CID, 5.7L/LX, 6.2L MPI V8 (1983 + 2003)	236
330, 340MIE, 370TRS, 454EFI, 454MAG, 7.4MIE/LX, GM454 CID V8	238
502 EFI/MAG, 8.2L, GM502 CID V8	238
325-325MIE, GM427 CID V8 330/MIE 370TRS - 400TRS - 440TRS - GM454 CID 390 - 390MIE - 460TRS, GM472 CID V8 225/MIE - 250/MIE - GM327CID - 228/MIE GM305CID - 250 - 270 - 270MIE - 280TRS - GM350 CID V8	240
215, 225/MIE, 888 Ford 302 V8 233, 233MIE, 255/MIE, Ford 351 V8	241
CODOS	245
CODO ESCAPE INOX	247
EXTENSORES ESCAPE	249
KIT RISER 3"	248
KIT RISER 6"	249
TAPONES	249
COLECTORES	242
COLECTOR ADMISIÓN	254
TAPAS Y JUNTAS	250
FUELLES ESCAPE	253
JUNTAS COLECTOR-CODO	251
JUNTAS COLECTOR-CULATA	252
JUNTAS TAPA INTERCAMBIADOR	251
JUNTAS TAPAS LATERALES	250
PALOMILLA ESCAPE	253
TAPA COLECTOR	250



# MERCUISER CUMMINS

<b>UNIDADES DE TRANSMISIÓN</b>	255	<b>DESPIECE COLAS</b>	258	<b>POWER TRIM</b>	305
ALPHA ONE GEN II	257	R   MR   ALPHA ONE	258	120-140-165-228-250-260-470-485-888-898	305
BRAVO	255	MC1   R	260	R/MR/ALPHA ONE	306
MC1   R   MR   ALPHA ONE	256	MR   ALPHA ONE	264	ALPHA ONE GEN II	307
R   MR   ALPHA ONE	256	ALHPA ONE GEN II	268	BRAVO	308
ACOPLAMIENTO MOTOR	305	BRAVO	276	LATIGUILLOS POWER TRIM	309
ÁNODOS	284	BRAVO I	278	SILENBLOCK	304
ÁNODO CANADA METAL	288	BRAVO II	280	SOPORTE MOTOR	303
ÁNODO RECMAR	284	BRAVO III	282	TRANSOM	290
ÁNODO TECNOSEAL	286	HERRAMIENTAS	310	ALPHA ONE GEN I & II	290
<b>CAMBIO</b>	300	ADAPTADOR EMBASES ACEITE	314	BRAVO	296
ACOPLE	302	CENTRADOR DE MOTOR	312	CAMPANA BRAVO	296
ACTUADOR CAMBIO ELECTRÓNICO	302	EXTRACTOR	313	CAMPANA, CABLE CAMBIO Y BOMBA DIRECCION	292
CABLE	300	EXTRACTOR DE COJIENTES Y HÉLICES	310	CAMPANA MC, MR1, ALPHA ONE, GEN II	294
CABLE, KIT	300	EXPANSOR DE FUELLES	312	SOPORTE ALPHA ONE GEN II	293
CABLES DIRECCION PRETEC	301	EXTRACTOR DE PIÑONES	310	SOPORTE TRANSOM BRAVO I, II, & III	298
EJE CABLE CAMBIO	302	EXTRACTOR POLEA BOMBA DE DIRECCION	311	TRANSOM COMPLETO	291
GUÍA CABLE	303	EXTRACTOR TAPONES TRIM	312		
KITS CAMBIO	302	HERRAMIENTAS PARA COLAS	311		
KIT RETÉN	303	LLAVE ESTRIADO EJE	312	<b>SISTEMA DE PROPULSIÓN</b>	315
TORNILLO Y PASADOR	302	LLAVE GALGADO PIÑONES	312	HÉLICES AL E INOX DE 3 Y 4 PALAS	315
<b>COMPONENTES TRANSOM</b>	299	LLAVE PARA ELEMENTOS DEL CAMBIO	313	GUÍA HÉLICES CON NÚCLEO INTEGRADO	316
ABRAZADERA FUELLE CAMBIO	300	LLAVE TORNILLO LATERAL TRANSOM	312	HÉLICES PARA BRAVO III	317
CLIP FUELLE	300	LLAVE TUERCA CARDAN	314	HÉLICES PARA ALPHA ONE & BRAVO I	317
FUELLE ESCAPE	300	LLAVE TUERCA DIÁBOLO	311	TABLA DE APLICACIÓN SOLAS	318
KIT FUELLE	299	LLAVE TUERCA EJE VERTICAL	311		
KIT FUELLE CAMBIO	299	PISTOLA DE ACEITE	314		
KIT JUNTAS	299	ÚTIL INSTALACIÓN ANILLO DE FUELLE	312	REF --> RO	319
		VACUOMETRO DOBLE FUNCIÓN	314	RO --> REF	330

EN

<b>DRIVES MAINTENANCE KIT</b>	108	<b>CARBURETOR</b>	132	<b>ELECTRIC SYSTEM</b>	144
GENERIC MATERIALS FOR REVISION	109	CARBURATOR ADAPTER KITS	135	ALTERNATORS & VOLTAGE REGULATORS	153
GUIDE: ENGINE MAINTENANCE	104	CARBURETORS: NEW	133	ALTERNATOR CONVERSION KIT	155
GUIDE: IDENTIFICATION MODEL	102	CARBURATORS: REBUILT	132	VOLTAGE REGULATOR FOR ALTERNATOR	155
GUIDE: MAINTENANCE TRASMISSIONS	108	CHOKE	142	<b>SENSORS</b>	144
		FLAME ARRESTORS	142	AIR TEMPERATURE	148
		FLOAT	136	AIR VALVE	145
<b>FUEL &amp; FILTRATION SYSTEM</b>	110	FUEL TUBE FROM PUMP --> CARBURATOR	135	CAMSHAFT	146
<b>GAS ENGINE</b>		GASKET	137	COMPLETE TEMPERATURE & OI PRESSURE WARNING KIT	147
AIR FILTER	113	GASKET KITS	139	COOLANT TEMPERATURE	148
FUEL FILTERS AND ELEMENTS	110	GUIDE: GASKET KITS	140	CRANKSHAFT	146
BRACKET	110	INLET NEEDLE KIT	136	GUIDE	149
BRASS RACCORS	112	SCREW	136	IAC	145
CARBURETOR FUEL FILTER	113	<b>FILTER ACCESSORIES</b>	123	KNOCK	145
COMPLETE FUEL FILTER	111	<b>FUEL PUMP</b>	124	MAT/MAP	144
IN-LINE FUEL FILTER	112	COMPLETE FUEL MODULE	128	OIL PRESSURE	147
VST FILTER	113	ELECTRIC FUEL PUMP & COOLER	129	OXYGEN	145
WATER SEPARATING FUEL FILTER	110	FUEL PRESSURE REGULATOR	129	PICK UP	145
<b>OIL FILTER</b>	114	GASKET	125	TPS	144
FOR AXIUS POWER STEERING	114	HIGH PRESSURE FUEL PUMP	126	TRIM	146
GUIDE	115	LOW PRESSURE FUEL PUMP	127	WATER	148
		MECHANICAL	124	WATER TEMPERATURE	148
<b>DIESEL</b>		MECHANICAL PUMP GUIDE	125	<b>SOLENOID, RELAY &amp; FUSES</b>	157
AIR FILTER	120	VST GASKETS	129	ALARM	160
FUEL FILTERS AND ELEMENTS	116	<b>INJEKTOR</b>	130	ATM, ATC, MAXI FUSES	159
BOWLS FILTER	117	FUEL INJEKTOR SEAL KIT	131	BATTERY SWITCH FUSES	159
COMPLETE DIESEL FILTER	118	<b>TURBO</b>	143	CIRCUIT BREAKER	158
FILTER SYPE SEPAR2000	120	EXHAUST CLAMP	143	DELCO REMY SOLENOID	157
<b>OIL FILTER</b>	121	GASKET KIT	143	IGNITION KILL SWITCH	160
GUIDE	122	SEAL	143	MERCATHODE	159
TRANSMISSION HURT FILTER	121	<b>RACOR</b>	122	POWER TRIM SWITCH ASSY	160



RELAY	158
RELAY FOR ALARM & OTHERS	158
RELAY FOR IGNITION & FUEL PUMP	158
RELAY FOR THROTTLE AND SHIFT	158
SOLENOID	157
SOLENOID EXTENSOR FOR TERMINALS	157
STARTER SOLENOID	157
TRIM FUSE	158
TRIM SOLENOID	157
STARTERS	151
TRIM	155
3 TO 2 WIRE WIRED CONVERTER	156
BRACKET	156
RESERVOIR	156
TRIM ASSY	155

### IGNITION SYSTEM 161

DISTRIBUTOR	168
CAP	168
CONDENSERS	170
DISTRIBUTOR	175
ELECTRONIC CONVERSION KITS	172
ELECTRONIC CONVERSION KITS GUIDE	172
ELECTRONIC DISTRIBUTOR	176
IGNITION APPLICATION GUIDE	171
PARTS	173
• DELCO VOYAGER	173
• MPI V6 & V8	175
• THUNDERBOLT IV & V	174
POINTS	170
ROTORS	169
TRIGGERS	169
TUEN UP KITS	170
IGNITION COIL	161
ELECTRONIC IGNITION	161
IGNITION MODULES	162
SPARK PLUG	163
HD SPARK PLUG WIRES SET	167

### COOLING SYSTEM 177

BELTS	194
SERPENTINE BELTS GUIDE	197
V-BELTS GUIDE	198
V-BELT GUIDE DIESEL	195
V-BELT GUIDE GAS	195
HEAT EXCHANGER	183
KITS	183
HOSES	198
CYLINDER HEAD --> EXHAUST MANIFOLD	198
HOSES FUEL GUIDE	202
HOSES FUEL GUIDE (SHAFT --> FUEL)	203
HOSES FUEL GUIDE (STERN DRIVES)	201
OIL COOLER	199
OIL COOLER --> THERMOSTAT HOUSING	199
SEAWATER PUMP --> OIL COOLER	199
THERMOSTAT HOUSING --> EXHAUST MANIFOLD	200
TRANSOM --> OIL COOLER	199
WATER PUMP	199
WATER SYSTEM	198
IMPELLER GUIDE	188
OIL COOLER	184
KITS	184
RESERVOIR ASSY KIT	185
THERMOSTAT	177
CHECK BALL KIT	179
FITTING	179
GASKETS	180
SLEEVE	178
TEE VALVE	179
THERMOSTAT COVER	180
THERMOSTAT DIESEL	181
THERMOSTAT HOUSING	177
THERMOSTAT HOUSING KIT	177
THERMOSTAT KITS	181
WATER DISTRIBUTION MODULE	179
WATER PUMPS	185
BRASS WATER PUMP	186
GASKET	187
WATER PUMP SERVICE KIT	189
1   R   MR   ALPHA ONE	189
ALPHA ONE GEN II	190
BRAVO I, II & III	191
BELT TENSIONER V6 & V8	194
PARTS	192
WATER PUMPS PULLEY	193

### ENGINE PARTS 204

MARINE GASKETS TO GM & FORD ENGINES	204
SEALS	215
CRANCKSHAFT SEAL	216
CRANCKSHAFT SEAL GUIDE	216
ENGINE GASKETS	217
INTAKE VALVE	216
O-RING GUIDE	217
OIL SEAL GUIDE	216
VALVE STEAM SEAL	216
TIMING GASKETS	215
TIMING CHAIN COVER GASKETS	215

### EXHAUST & INTAKE SYSTEM 218

120 HP GM 153	218
ELBOW MANIFOLD	218
ELBOW MANIFOLD GASKET	218
END CAP	218
END CAP GASKET	218
EXHAUST MANIFOLD	218
MANIFOLD GASKET	218
CAPS & GASKETS	250
END CAP MANIFOLD	250
EXHAUST BELLOW	253
HEAD EXCHANGER END CAP	251
MANIFOLD-ELBOW GASKET	251
MANIFOLD-HEAD GASKET	252
SIDE GASKET CAP	250
WATERS HUTTER	253
ELBOWS	245
CAPS	249
EXHAUST EXTENSIONS	249
KIT RISER 3"	248
KIT RISER 6"	249
SS EXHAUST ELBOW	249
INTAKE MANIFOLD	254
MANIFOLDS	242
MANIFOLDS & ELBOWS PARTS	219
140HP GM181	219
2.5L GM 153 4 cyl, 3.0L 4 cyl (1983-89)	220
3.0L/LX GM 181	222
3.0L MPI	223
165, 170, 180, 190, 470, 485, 488	224
3.7L/LX MCM 224 CID	224
GM 160, 165, 200CID, 250, 292CID	225
175, 185, 205, 262 MAG,	226
4.3L/LX/LH/LXH/EFI/MPI, GM 262 CID V6	228
4.3L CARB MPI ALPHA/BRAV	228
262 MAG (TBI), 4.3L/LH/LX/EFI (GEN+), GM	230
262 V6 (1996-01)	231
V6	231
305, 350, 377, 383, 385, (6.2L)	232
MAG MPI HORIZON ALPHA/BRAVO	232
V8 SMALL BLOCK	234
198MIE, 228/MIE & 898, GM305CID, V8	235
250, 255MIE & 260	235
200, 228, 230, 230 MIE, 5.0L/LX, 898,	236
5.0L MPI, GM305 CID, 260/MIE, 320 EFI,	236
350 MAG, GM350 CID, 5.7L/LX, 6.2L MPI	236
V8 (1983 + 2003)	238
330, 340MIE, 370TRS, 454EFI, 454MAG,	238
7.4MIE/LX, GM454 CID V8	238
502 EFI/MAG, 8.2L, GM502 CID V8	240
325-325MIE, GM427 CID V8 330/MIE	240
370TRS - 400TRS - 440TRS - GM454 CID	240
390 - 390MIE - 460TRS, GM472 CID V8	240
225/MIE - 250/MIE - GM327CID - 228/	240
MIE GM305CID - 250 - 270 - 270MIE -	240
280TRS - GM350 CID V8	241
215, 225/MIE, 888 Ford 302 V8 233,	241
233MIE, 255/MIE, Ford 351 V8	241

### TRANSMISSION UNIT 255

ALPHA ONE GEN II	257
BRAVO	255
MC1   R   MR   ALPHA ONE	256
R   MR   ALPHA ONE	256
ANODES	284
CANADA METAL	288
RECMAR	284
TECNOSEAL	286
ENGINE MOUNT SCREW	305
ENGINE COUPLER ASSEMBLIES	305
GEAR CASE PARTS	258
R   MR   ALPHA ONE	258
MC1   R	260
MR   ALPHA ONE	264
ALPHA ONE GEN II	268

BRAVO	276
BRAVO I	278
BRAVO II	280
BRAVO III	282
POWER TRIM	305
120-140-165-228-250-260-470-485-	305
888-898	305
R/MR/ALPHA ONE	306
ALPHA ONE GEN II	307
BRAVO	308
POWER TRIM HOSES	309
TRIM PLUGS EXTRACTOR	310
SHIFT	300
CABLE	300
CABLE GUIDE	303
CABLE SLIDE	302
DIGITAL SHIFT ACTUATOR	302
SCREW & PIN	302
SEAL KIT	303
SHIFT CABLE ASSY KIT	300
SHIFT LEVER KIT	302
STEERING CABLE, PRETECH	301
UPPER SHIFT SHAFT	302
SILENBLOCK	304
TOOLS	310
ADAPTOR FOR RECLUBE CONTAINERS	314
BEARING CARRIER RETAINER WRENCH	311
BEARING PULLER	310
BEARING RETAINER WRENCH	314
BELLOW RINGS INTALLATION TOOL	312
BELLOWS EXPANDER TOOLS	312
BOTTLE GREASE PUMP	314
ENGINE ALIGNMENT TOOL	312
GEAR CASE TOOL KIT	311
HINGE PIN TOOL	312
PINION GEAR SHIMMING TOOL	312
PRESSURE / VACUUM TESTER	314
PROP & BEARING PULLER	310
PROP SHAFT ADAPTOR	312
PROP WRENCH KIT	311
PULLEY REMOVER	311
PULLEY ROD	313
TOOLS FOR ELEMENTS TO DRIVESHAFT	313
TRANSOM	290
BELL HOUSING BRAVO	297
BELL HOUSING MC, MR1, ALPHA ONE,	294
GEN II	294
GIMBAL HOUSING BRAVO	296
GIMBAL HOUSING ET POWER STEERING	290
CYLINDER KIT ALPHA ONE GEN I & II	290
GIMBAL HOUSING RING ASSY. BRAVO I,	298
II, & III	298
GIMBALL HOUSING RING ASSY ALPHA	293
ONE GEN II	293
TRANSOM ASSY	290
TRANSOM PLATE, SHIFT CABLE & PUMP	292
ASSY. POWER STEERING	292
TRANSOM COMPONENTS	299
BELLOW KIT	300
EXHAUST BELLOW	300
GASKET SET	299
SHIFT CABLE BELLOW CLAMP	300
SHIFT CABLE BELLOW KIT	299
U-JOINT BELLOWS KIT	299

### PROPULSION SYSTEM 315

3 & 4 BLADE AL & SS PROPELLERS	315
PROPELLERS APPLICATION WITH RUBBER	316
HUB	317
PROPELLER FOR BRAVO III	317
PROPELLER FOR ALPHA ONE & BRAVO I	317
PROPELLERS SOLAS APPLICATION GUIDE	318

REF --> OEM	319
OEM --> REF	330



GUIDA DI IDENTIFICAZIONE MODELLO MOTORE	102
GUIDA MANUTENZIONE MOTORI	104
GUIDA MANUTENZIONE TRASMISSIONI	108
KIT MANUTENZIONE PIEDE	108
MATERIALE GENERICO PER LA REVISIONE	109

## SISTEMA DI ALIMENTAZIONE E FILTRAZIONE 110

<b>BENZINA</b>	
FILTRI ARIA	113
FILTRI BENZINA E RACCORDI	110
FILTRO CARBURATORE	113
FILTRO DECANTATORE	111
FILTRO PER MONTARE IN LINEA	112
FILTRO SEPARATORE ACQUA-BENZINA	110
FILTRO VST	113
RACCORDI IN OTTONE	112
SUPPORTO	110
FILTRO OLIO	114
PER MOTORI CON STERZZO IDRULICO AXIUS	114
GUIDA	115

<b>DIESEL</b>	
FILTRO ARIA	120
FILTRI BENZINA E ELEMENTI	116
FILTRO CON COPPA	117
FILTRO DECANTATORE	118
FILTRO DI TIPO SEPAR2000	120
FILTRO TRASMISSIONE HURT	121
FILTRO OLIO	121
GUIDA	122

ACCESSORI PER FILTRI	123
CARBURATORE	132
CARBURATORE NUOVI	133
CARBURATORE RIGENERATI	132
CHOKE	142
GALLEGGIANTI	136
GUARNIZIONE	137
GUIDA	139
GUIDA KIT	140
KIT ADATTATORE CARBURATORI	135
KIT SPILLO	136
PARAFIAMMA	142
TUBO DA COMBUSTIBILE, POMPA --> CARBURATORE	135
VITI	136
INIETTORE	130
KIT PARAOLIO	131
POMPA COMBUSTIBILE	124
GUARNIZIONE VST	129
GUARNIZIONI	125
GUIDA POMPI MECCANICHE	125
MODULO CARBURANTE COMPLETO	128
POMPA ALTA PRESSIONE	126
POMPA BASSA PRESSIONE	127
POMPA BENZINA E KIT SCAMBIATORE	129
POMPA MECCANICA	124
REGOLATORI PRESSIONE CARBURANTE	129
RACCORDI	122
TURBINE	143
KIT GUARNIZIONE	143
FASCETTA SCARICO	143
PARAOLIO	143

## SISTEMA ELETTRICO 144

ALTERNATORI E REGOLATORI	153
KIT SOSTITUZIONE ALTERNATORE	155
REGOLATORE ALTERNATORE	155
MOTORINI AVVIAMENTO	151
SENSORE	144
ACQUA	148
ALBERO A CAMES	146
DI CADUTA	145
GUIDA	149
IAC	145
MAT/MAP	144
OXSSIGENO	145
PICK UP	145
POSIZIONE ALBERO MOTORE	146
POSIZIONE ASSE A CAMME	146
PRESSIONE OLIO	147
TEMPERATURA ACQUA	148
TEMPERATURA ARIA	148

TEMPERATURA E PRESSIONE DELL'OLIO	147
TEMPERATURA SCAMBIATORE	148
TPS	144
TRIM	146
VALVOLA ARIA	145
SOLENOIDI, RELÉ E FUSIBILE	157
ALLARME	160
FUSIBILE ATM, ATC, MAXI	159
FUSIBILE MOTORE	158
FUSIBILE MOTORINI TRIM	158
FUSIBILE TERMINALE BATERIA	159
INTERRUTTORE TRIM	160
INTERRUTTORI DI STOP	160
MERCATHODE	159
PROLUNGA TERMINALE PER SOLENOIDE	157
RELÉ	158
RELÉ DI ACCELERATORE E ASSE	158
RELÉ DI AVVIAMENTO E POMPA BENZINA	158
RELÉ PER ALARMA E ALTRI	158
SOLENOIDI	157
SOLENOIDI AVVIAMENTO	157
SOLENOIDI DELCO REMY	157
SOLENOIDI TRIM	157
TRIM	155
CONVERTITORE CAVI DA 3 A 2 FILI	156
SUPPORTO	156
TRIM COMPLETO	155
VASCHETTA	156

## SISTEMA ACCENSIONE 161

BOBINA	161
ACCENSIONE ELETTRONICA	161
CANDELE	163
KIT CAVI CANDELE ALTE PRESTAZIONI	167
MODULI AVVIAMENTO	162
SPINTEROGENE	168
CALOTTE	168
CONDENSATORI	170
ESPLOSO	173
• DELCO VOYAGER	173
• MPI V6 & V8	175
• THUNDERBOLT IV & V	174
GUIDA KIT CONVERSIONE ELETTRICO	172
GUIDA KITS DE ACCENSIONE	171
KIT D'ACCENSIONE	170
KIT DI CONVERSIONE ELETTRICO	172
PUNTINE	170
ROTORI	169
SPINTEROGENO	175
SPINTEROGENO ELETTRICO	176
TRIGGERS	169

## SISTEMA DI RAFFREDDAMENTO 177

CINGHIA	194
GUIDA BENZINA	195
GUIDA CINGHIA MOTORE	198
GUIDA CINGHIA SERPENTINA	197
GUIDA DIESEL	195
GUIDA GIRANTE	188
KIT RICAMBI	189
1   R   MR   ALPHA ONE	189
ALPHA ONE GEN II	190
BRAVO I, II & III	191
ESPLOSO	192
PULIGGIA POMPE	193
TENDICINGHIA V6 & V8	194
MANICOTTO MOTOR	198
CORPO TERMOSTATO --> COLLETTOR SCARICO	200
GUIDA MANICOTTO	202
GUIDA MANICOTTO ASSE-->BENZINA	203
GUIDA MANICOTTO PIEDE	201
POMPA ACQUA	199
POMPA ACQUA --> SCAMBIATORE OLIO	199
PRESA ACQUA	198
SCAMBIATORE OLIO	199
SCAMBIATORE OLIO --> CORPO TERMO-STATO	199
TESTATA --> COLLETORE DI SCARICO	198
TRANSOM --> SCAMBIATORE OLIO	199
POMPE ACQUA	185
GUARNIZIONE	187
POMPE IN BRONZO	186
RAFFREDDAMENTO DELL'OLIO	184

KIT BOTTIGLIA OLIO	185
KIT RAFFREDDAMENTO	184
SCAMBIATORE DI CALORE	183
KIT	183
TERMOSTATO	177
ASSE VALVOLA	179
BOCCOLA	178
CONNECTTORE	179
COPERCHIO	180
CORPO	177
GUARNIZIONE	180
KIT CORPO TERMOSTATO	177
KIT TERMOSTATO	181
MODULO DISTRIBUZIONE	179
TERMOSTATO DIESEL	181
VALVOLA T	179

## PARTI MOTORE 204

GUARNIZIONE MOTORI GM E FORD	204
GUARNIZIONE DISTRIBUZIONE	215
GUARNIZIONE CARTER	215
TENUTE	215
GUARNIZIONE MOTORE 4CYL LINEA	217
GUIDA O-RING	215
GUIDA PARAOLIO	216
GUIDA PARAOLIO ALBERO MOTORE	216
PARAOLIO VALVOLE	216
VALVOLA ASPIRAZIONE	216

## SISTEMA DI ESCARICO E ASPIRAZIONE 218

120 HP GM 153	218
COLLETORE SCARICO	218
COPERCHIO COLLETORE	218
GOMITO DI SCARICO	218
GUARNIZIONE COLLETORE	218
GUARNIZIONE DI SCARICO	218
GUARNIZIONE COPERCHIO COLLETORE	218
COLLETTORI	242
COLLETORE ASPIRAZIONE	254
COPERCHI E GUARNIZIONE	250
COPERCHIO COLLETORE	250
COPERCHIO POSTERIORE SCAMBIATORE	251
CUFFIA DI SCARICO	253
FARFALLA DI SCARICO	253
GUARNIZIONE COLLETORE-GOMITO	251
GUARNIZIONE COLLETORE-TESTATA	251
GUARNIZIONE COPERCHIO LATERALE	250
GOMITI	245
ESTENSIONI DI SCARICO	249
GOMITI SCARICO INOX	247
KIT RISER 3"	248
KIT RISER 6"	249
TAPPI	249
PARTI COLLETTORI E GOMITI	219
140HP GM181	219
2.5L GM 153 4 cyl, 3.0L 4 cyl (1983-89)	220
3.0L/LX GM 181	222
3.0L MPI	223
165, 170, 180, 190, 470, 485, 488	
3.7L/LX MCM 224 CID	224
GM 160, 165, 200CID, 250, 292CID	225
175, 185, 205, 262 MAG,	
4.3L/LX/LH/LXH/EFI/MPI, GM 262 CID V6	226
4.3L CARB MPI ALPHA/BRAV	228
262 MAG (TBI), 4.3L/LH/LX/EFI (GEN+), GM 262 V6 (1996-01)	230
V6	231
305, 350, 377, 383, 385, (6.2L)	
MAG MPI HORIZON ALPHA/BRAVO	232
V8 SMALL BLOCK	234
198MIE, 228/MIE & 898, GM305CID, V8 250, 255MIE & 260	235
200, 228, 230, 230 MIE, 5.0L/LX, 898, 5.0L MPI, GM305 CID, 260/MIE, 320 EFI, 350 MAG, GM350 CID, 5.7L/LX, 6.2L MPI V8 (1983 + 2003)	
330, 340MIE, 370TRS, 454EFI, 454MAG, 7.4MIE/LX, GM454 CID V8	238
502 EFI/MAG, 8.2L, GM502 CID V8	
325-325MIE, GM427 CID V8 330/MIE 370TRS - 400TRS - 440TRS - GM454 CID 390 - 390MIE - 460TRS, GM472 CID V8 225/MIE - 250/MIE - GM327CID - 228/MIE GM305CID - 250 - 270 - 270MIE - 280TRS - GM350 CID V8	240
215, 225/MIE, 888 Ford 302 V8 233, 233MIE, 255/MIE, Ford 351 V8	241

**UNITÀ DI TRASMISSIONE** 255

ALPHA ONE GEN II	257
BRAVO	255
R   MR   ALPHA ONE	256
MC1   R   MR   ALPHA ONE	256
ACCOPIAMENTO MOTORE	305
ANODI	284
ANODO CANADA METAL	288
ANODO RECMAR	284
ANODO TECNOSEAL	286
ATTREZZI	
ADATTATORE PER CONTENITORI RECLUBE	
ATTREZZO PER CUFFIE	
CENTRATORE MOTORE	
CHIAVE ASSE STRITO	
CHIAVE CARDANO	
CHIAVE PER CUSCINETTO	
CHIAVE PER GLI ELEMENTI DEL CAMBIO	
CHIAVE PER PEIGNONI	
CHIAVE VITE LATERALE TRANSOM	
ESTRATTORE	
ESTRATTORE CUSCINETTI E ELICHE	
ESTRATTORE PIGNONE	
KIT ATTREZZI PIEDI	
KIT CHIAVE ELICA	
PISTOLA OLIO	
STRUMENTO PER L'INSTAL. DELL'ANELLO DEL SOFFIETTO	
VACUOMETRO DOPPIA FUNZIONE	
CAMBIO	300
ACCOPIO	302
ALBERINO CAMBIO	302
ATTUATORE CAMBIO	302
CAVI DI TIMONERIA PRETEC	301
CAVO	300
GUIDA CAVO	303
KIT CAMBIO	302
KIT CAVO	300
KIT TENUTE	303
VIS E SPINOTTO	302
COMPONENTI TRANSOM	299
CLIP FUELLE	300
CUFFIE DI SCARICO	300
FASCETTA CUFFIE CAMBIO	300
KIT CUFFIE	299
KIT CUFFIE CAMBIO	299
KIT GUARNIZIONI	299
PARTI PIEDI	258
R   MR   ALPHA ONE	258
MC1   R	260
MR   ALPHA ONE	264
ALPHA ONE GEN II	268
BRAVO	276
BRAVO I	278
BRAVO II	280
BRAVO III	282
POWER TRIM	305
120-140-165-228-250-260-470-485-888-898	305
R/MR/ALPHA ONE	306
ALPHA ONE GEN II	307
BRAVO	308
ESTRATTORE PER TAPPI TRIM	310
TUBI POWER TRIM	309
SILENBLOCK	304
SUPPORTI MOTORE	303
TRANSOM	290
ALPHA ONE GEN I & II	290
BRAVO	296
CAMPANA BRAVO	296
CAMPANA MC, MR1, ALPHA ONE, GEN II	294
CAMPANA, CAVO CAMBIO E POMPA STERZO	292
SUPPORTO ALPHA ONE GEN II	293
SUPPORTO TRANSOM BRAVO I, II, & III	298
TRANSOM COMPLETO	291

**SISTEMA DI PROPULSIONE** 315

ELICHE AL E INOX DE 3 E 4 PALE	315
ELICHE PER ALPHA ONE & BRAVO I	317
ELICHE PER BRAVO III	317
GUIDA APPLICAZIONE ELICHE SOLAS	318
GUIDA ELICHE CON MOZZO	316

REF --&gt; RO 319

RO --&gt; REF 330

GUIDE D'IDENTIFICATION MOTEURS	102
GUIDE MAINTENANCE MOTEURS	104
GUIDE MAINTENANCE TRANSMISSIONS	108
KIT D'ENTRETIEN DES EMBASSES	108
MATÉRIAUX GÉNÉRIQUES POUR L'EXAMEN	109

**SYSTÈME D'ALIMENTATION ET FILTRATION** 110

<b>ESSENCE</b>	
FILTRE AIRE	113
FILTRE À HUILE	114
PARÀ DIRECCIÓN HIDRÁULICA AXIUS	114
GUÍA	115
FILTRE ET CARTOUCHES DE RECHANGE	110
BRACKET	110
FILTRE À ESSENCE CARBURATEUR	113
FILTRE À ESSENCE EN LIGNE	112
FILTRE DÉCANTATEUR	111
FILTRE SÉPARATEUR D'EAU	110
FILTRE VST	113
RACCORDS À LAITON	112

<b>DIESEL</b>	
FILTRE AIRE	120
FILTRE À HUILE	121
GUIDE	122
FILTRE ET CARTOUCHES DE RECHANGE	116
FILTRE AVEC COUPE	117
FILTRE DÉCANTATEUR	118
FILTRE TYPE SEPAR2000	120
FILTRE TRANSMISSION HURT	121

ACCESSOIRE POUR FILTRES	123
CARBURATEUR	132
ARRÊTEURS DE FLAMMES	142
CARBURATEUR NOUVEAU	133
CARBURATEUR REMANUFACTURÉS	132
CHOKE	142
FLOTEURS	136
GUIDE	139
GUIDE DES KITS	140
JOINTS	137
KIT ADAPTEURS	135
KIT POINTEAU	136
TUYAU, POMPE --> CARBURATEUR	135
VIS	136
INJECTEURS	130
KIT JOINTS	131
POMPE À CARBURANT	124
GUIDE DE POMPES MECANQUES	125
JOINTS	125
JOINTS VST	129
MODULE DE CARBURANT COMPLET	128
POMPE BASE PRESSION	127
POMPE ET REFRIGÉRISEUR	129
POMPE HAUTE PRESSION	126
POMPE MECANIQUE	124
REGULATEUR PRESSION DE CARBURANT	129
RACCORDS	122
TURBO	143
KIT JOINTS	143
COLLIER ÉCHAPPEMENT	143
JOINT SPI DE TURBO	143

**SYSTÈME ÉLECTRIQUE** 144

ALTERNATEURS ET REGULATEURS	153
KIT ALTERNATEUR	155
REGULATEUR ALTERNATEUR	155
CAPTEURS	144
CAPTEUR DE CLIQUETIS	145
GUIDE DES SONDAS	149
IAC	145
MAT/MAP	144
OXYGENE	145
PICK UP	145
PRESSION D'HUILE	147
SONDE DE L'EAU	148
SONDE POSITION ARBRE À CANNES	146
SONDE POSITION VILEBREQUIN	146
SOUPAPE D'AIRE	145
TEMPERATURE DE REFRIGÉRISEUR	148
TEMPERATURE DE L'AIRE	148
TEMPERATURE DE L'EAU	148
TEMP. ET PRESSION D'HUILE AVEC ALARME	147
TPS	144
TRIM	146



DÉMARREUR	151
SOLÉNOÏDE, RELAIS ET FUSIBLES	157
BUZZER D'ALARME	160
COMMUTATEUR DE TRIM	160
EXTENSION POUR SOLÉNOÏDE	157
FUSIBLE ATM, ATC, MAXI	159
FUSIBLE MOTEUR	158
FUSIBLE TERMINAL DE BATERIE	159
FUSIBLE TRIM	158
INTERRUPTEUR DE STOP	160
MERCATHODE	159
RELAIS	158
RELAIS DE DÉMARREUR ET POMPE D'ESSENCE	158
RELAIS POUR ALARME ET D'AUTRES	158
RELAIS POUR L'ACCELERATION ET L'ARBRE SOLÉNOÏDE	158
SOLÉNOÏDE	157
SOLÉNOÏDE DELCO REMY	157
SOLÉNOÏDE DÉMARREUR	157
SOLÉNOÏDE TRIM	157
TRIM	155
FAISCEAU CONVERTISSEUR 3 À 2 FILS	156
RESERVOIR	156
SUPPORT	156
TRIM COMPLET	155

## SYSTÈME D'ALLUMAGE 161

ALLUMEUR	168
CONDENSATEUR	170
DISTRIBUTEUR	175
DISTRIBUTEUR ÉLECTRONIQUE	176
DOIGT D'ALLUMEUR	169
GUIDE KITS D'ALLUMAGE	171
GUIDE KITS DE CONVERSION ÉLECTRONIQUE	172
KIT DOIGT D'ALLUMEUR	169
KITS DE CONVERSION ÉLECTRONIQUE	172
KITS S'LLUMAGE	170
PIÈCES	173
• DELCO VOYAGER	173
• MPI V6 & V8	175
• THUNDERBOLT IV & V	174
TÊTE D'ALLUMEUR	168
VIS PLATINÉS	170
BOBINE D'ALLUMAGE	161
ALLUMAGE ÉLECTRONIQUE	161
BOUGIES	163
KIT FAISCEAU DE BOUGIE	167
MODULES D'ALLUMAGE	162

## SYSTÈME DE REFROIDISSEMENT 177

COURROIES	194
GUIDE DE COURROIES MOTEUR	198
GUIDE DE COURROIES SERPENTINE	197
GUIDE DIESEL	195
GUIDE GAS	195
ÉCHANGEUR DE CHALEUR	183
KITS	183
GUIDE TURBINES	188
KIT REPARATION DE POMPE À EAU	189
1   R   MR   ALPHA ONE	189
ALPHA ONE GEN II	190
BRAVO I, II & III	191
PIÈCES	192
POULIE	193
TENDEUR DE COURROIE V6 & V8	194
POMPE D'EAU	185
POMPE À EAU BRONZE	186
JOINTS	187
REFROIDISSEUR D'HUILE	184
KITS REFROIDISSEUR	184
KITS RESERVOIR D'HUILE	185
THERMOSTAT	177
AXE VALVE	179
CALE	178
CORPS	177
COUVERCLE	180
JOINTS	180
KIT CORPS DE THERMOSTAT	177
KITS THERMOSTATS	181
MODULE DE DISTRIBUTION	179
RACCORD VIDANGE	179
THERMOSTATS DIESEL	181
VALVE T	179

TUAYAU MOTEUR	198
CORP THERMOSTAT --> D'ÉCHAPPEMENT	200
CULASSE --> COLLECTEUR D'ÉCHAPP.	198
ENTRÉE D'EAU	198
GUIDE TUYAUX	202
GUIDE TUYAUX ARBRE-ESSENCE	203
GUIDE TUYAUX D'EMBASE	201
POMPE D'EAU	199
POMPE D'EAU --> REFFROIDISSEUR D'HUILE	199
REFROIDISSEUR D'HUILE	199
REFROIDISSEUR --> CORP THERMOSTAT	199
TRANSOM --> REFFROIDISSEUR D'HUILE	199

## PIÈCES MOTEUR 204

JOINTS DISTRIBUTION	215
JOINTS COUVERCLE	215
JOINTS D'HUILE	215
GUIDE JOINTS D'HUILE	216
GUIDE JOINTS D'HUILE VILEBREQUIN	216
GUIDE JOINTS SPI	215
JOINT DE SOUPAPE	216
JOINTS D'HUILE VILEBREQUIN	216
JOINTS MOTEUR 4CYL EN LIGNE	217
SOUPAPE ADMISSION	216
JOINTS POUR MOTEUR GM ET FORD	204

## SYSTÈME ÉCHAPPEMENT ET ADMISSION 218

120 HP GM 153	218
COLLECTEUR D'ÉCHAPPEMENT	218
COUDE D'ÉCHAPPEMENT	218
COUVERCLE COLLECTEUR	218
JOINT COLLECTEUR	218
JOINT COUDE D'ÉCHAPPEMENT	218
JOINT COUVERCLE COLLECTEUR	218
COLLECTEURS	242
COLLECTEUR ADMISSION	254
COUDES	245
BOUCHONS	249
COUDES D'ÉCHAPPEMENT INOX	247
KIT RISER 3"	248
KIT RISER 6"	249
PROLONGATEURS D'ÉCHAPPEMENT	249
COUVERCLES ET JOINTS	250
CLAPET D'ÉCHAPPEMENT	253
COUVERCLE COLLECTEUR	250
SOUFFLET D'ÉCHAPPEMENT	253
JOINTS COLLECTEUR - COUDE	251
JOINTS COLLECTEUR-CULASSE	252
JOINTS COUVERCLE LATERAL	250
JOINTS DE L'ÉCHANGEUR	251
PIÈCES COLLECTEURS ET COUDES	219
140HP GM181	219
2.5L GM 153 4 cyl, 3.0L 4 cyl (1983-89)	220
3.0L/LX GM 181	222
3.0L MPI	223
165, 170, 180, 190, 470, 485, 488	224
3.7L/LX MCM 224 CID	224
GM 160, 165, 200CID, 250, 292CID	225
175, 185, 205, 262 MAG,	226
4.3L/LX/LH/LXH/EFI/MPI, GM 262 CID V6	226
4.3L CARB MPI ALPHA/BRAV	228
262 MAG (TBI), 4.3L/LH/LX/EFI (GEN+),	230
GM 262 V6 (1996-01)	231
V6	231
305, 350, 377, 383, 385, (6.2L)	232
MAG MPI HORIZON ALPHA/BRAVO	232
V8 SMALL BLOCK	234
198MIE, 228/MIE & 898, GM305CID, V8	235
250, 255MIE & 260	235
200, 228, 230, 230 MIE, 5.0L/LX, 898,	236
5.0L MPI, GM305 CID, 260/MIE, 320 EFI,	236
350 MAG, GM350 CID, 5.7L/LX, 6.2L MPI	236
V8 (1983 + 2003)	236
330, 340MIE, 370TRS, 454EFI, 454MAG,	238
7.4MIE/LX, GM454 CID V8	238
502 EFI/MAG, 8.2L, GM502 CID V8	238
325-325MIE, GM427 CID V8 330/MIE	240
370TRS - 400TRS - 440TRS - GM454 CID	240
390 - 390MIE - 460TRS, GM472 CID V8	240
225/MIE - 250/MIE - GM327CID - 228/	240
MIE GM305CID - 250 - 270 - 270MIE -	240
280TRS - GM350 CID V8	240
215, 225/MIE, 888 Ford 302 V8 233,	241
233MIE, 255/MIE, Ford 351 V8	241

## EMBASES ET PIÈCES 255

ALPHA ONE GEN II	257
BRAVO	255
MC1   R   MR   ALPHA ONE	256
R   MR   ALPHA ONE	256
ACCOUPEMENT MOTEUR	305
ANODES	284
ANODE CANADA METAL	288
ANODE RECMAR	284
ANODE TECNOSEAL	286
CHANGEMENT	300
ACTIONNEUR DE CHANGEMENT ÉLECTRON.	302
ARBRE CHANGEMENT	302
ATTACHE	302
CÂBLE	300
CÂBLES DE COMMANDE PRETEC	301
GUIDE CÂBLE	303
KIT CÂBLE	300
KIT JOINT D'HUILE	303
KITS CHANGEMENT	302
VIS ET PIN	302
COMPONENTS TRANSOM	299
CLIPS	300
COLLIER SOUFFLET CHANGEMENT	300
KIT JOINTS	299
KIT SOUFFLET	299
KIT SOUFFLET CHANGEMENT	299
SOUFFLET D'ÉCHAPPEMENT	299
OUTILS	310
ADAPTEUR ARBRE DE TRANSMISSION	313
ADAPTEUR CONTENEURS D'HUILE RECLUBE	314
CLÉ POUR ARBRE D'HELICE	312
CLÉ POUR ARBRE VERTICAL	311
CLÉ POUR ÉCROU D'ARBRE	314
CLÉ POUR ÉCROU DE DIABOLO	311
CLÉ POUR PIGNONS	312
EXTRACTEUR DE POULIE	313
EXTRACTEUR DE ROULEMENTS	310
EXTRACTEUR DE ROULEMENTS ET D'HELICE	310
OUTIL D'ALIGNEMENT	312
OUTIL D'INSTALLATION ANNE DE SOUFFLET	312
OUTIL DE MONTAGE SOUFFLETS	312
OUTILS OUR EMBASES	311
PISTOLET POUR HUILE D'EMBASE	314
VACUOMETRE DOUBLE FONCTION	314
PIÈCES D'EMBASES	258
R   MR   ALPHA ONE	258
MC1   R	260
MR   ALPHA ONE	264
ALPHA ONE GEN II	268
BRAVO	276
BRAVO I	278
BRAVO II	280
BRAVO III	282
POWER TRIM	305
120-140-165-228-250-260-470-485-888-898	305
ALPHA ONE GEN II	307
BRAVO	308
R/MR/ALPHA ONE	306
EXTRACTEUR BOUCHONS DE TRIM	310
FLEXIBLE DE POWER TRIM	309
TRANSOM	290
ALPHA ONE GEN I & II	290
BRAVO	296
CASQUE BRAVO	296
CASQUE MC, MR1, ALPHA ONE, GEN II	294
CASQUE, CÂBLE CHANGEMENT ET POMPA DIRECTION	292
SUPPORT ALPHA ONE GEN II	293
SUPPORT TRANSOM BRAVO I, II, & III	298
TRANSOM COMPLET	291
SILENBLOCK	304
SUPPORT MOTEUR	303

## SYSTÈME DE PROPULSION 315

HÉLICES AL ET INOX DE 3 ET 4 PALES	315
GUIDE DES HÉLICES ET MOYEUX	316
HÉLICES POUR BRAVO III	317
HÉLICES POUR ALPHA ONE & BRAVO I	317
TABLEAU D'APPLICATION D'HÉLICES SOLAS	318
REF --> RO	319
RO --> REF	330

GUÍA IDENTIFICACIÓN DE MODELOS

MODEL IDENTIFICATION CHART

GUIDA DI IDENTIFICAZIONE MODELLO MOTORE

GUIDE D'IDENTIFICATION MOTEURS

	MOD.	S/N		
SEA RAY	3.0L	B787205-B917529	1988	
	4.3L	B785483-B921276	1988	
	4.3LX	B785981-B922330	1988	
	5.7L	B784799-B917017	1988	
	SRX5.7L, 350 MAG	B785241-B919012	1988	
	SRX7.4L, 454 MAG ALPHA	B785149-B924857	1988	
STERN DRIVES	SRX7.4L-H, 454 MAG BRAVO	B721206-B919343	1988	
	SRX7.4L, ALPHA	B803866-C348032	1988	
INBOARD ENGINES	SRX7.4L-H, BRAVO	B803872-B999972	1988	
	5.7L	B788204-B919356	1988	
RENAULT 4 CYL. (STERN DRIVE)	7.4L	B788179-B913769	1988	
	60	1887079-5049044	1965-68	
GM 4 CYL. (STERN DRIVE)	80	2049045-2851423	1966-69	
	90	2851424-3226957	1970-72	
GM 4 CYL. (STERN DRIVE)	110	1537370-2044033	1963-66	
	120	1666601-3377340	1964-72	
	120	3377341-3770649	1972-73	
	120	3770650-4952700	1974-77	
	120	4952701-5192048	1978	
	120	5192049-6229717	1979-82	
	120	6229718-6853913	1983-84	
	120	6853914-B531853	1985-86	
	120/2.5L	B531854-C853255	1987-89	
	140	2508261-6229717	1968-82	
	140/3.0L	6229718-C856558	1982-89	
	3.0L/LX	C856559+	1990	
	MERCURY MARINE 4 CYL. (STERN DRIVE)	470 (2 BBL)	4208730-5520114	1976-79
		470 (2 BBL)	5520115-6218036	1980-82
470 (2 BBL)		6218037-6916778	1983-84	
170 (2 BBL)		6916779	1985-86	
165/3.7L (2 BBL)		6916779	1987-89	
485 (2 BBL)		5685394-6218036	1980-82	
488 (4 BBL)		6170297-6916778	1983-84	
190 (4 BBL)		6916779	1985-86	
GM INLINE 6 CYL. (STERN DRIVE)	180/3.7LX (4 BBL)	6916779	1987-89	
	140	1538930-1725960	1963	
	150	1666495-2048046	1964-66	
	160	2048022-2770031	1967-69	
	165	2770032-5178958	1970-78	
	165	5178959-5813433	1979-81	
GM V6 (STERN DRIVE)	200	2453769-2712072	1969	
	185 (4 BBL)	6330183-6919655	1983-84	
	185 (2 BBL)	A331455-B527954	1985-87	
	175/4.3L (2 BBL)	B527955-D714106	1987-92	
	4.3L (GEN II) (2 BBL)	D714107-F000877	1992-93	
	4.3L (GEN II) (2 BBL)	F000878-F601126	1993-95	
	4.3L (GEN II) (2 BBL)	F601127-F000878	1996	
	4.3LX (GEN+) (2 BBL)	F803000-K999999	1996-97	
	4.3L (GEN+) (2 BBL)	L010044+	1998	
	4.3L EFI (GEN+) (TBI)	L012009+	1998	
	205 (4 BBL)	A331455-B527954	1985-87	
	205/4.3LX (4 BBL)	B527955-D714369	1987-91	
	4.3LX (GENII) (4 BBL)	D714370-F001219	1992-93	
	4.3LX (GENII) (4 BBL)	F001220-F601126	1993-95	
	4.3LX (GENII) (4 BBL)	F601127-F802999	1996	
	4.3LXH (GEN+) (4 BBL)	F803114+	1996-97	
4.3LH (GEN+) (4 BBL)	L010044+	1998		
FORD V8 (STERN DRIVE)	262 MAG (TBI) (GEN+)	F803800-K999999	1996-97	
	888 (2 BBL)	3108723-4887829	1971-77	
	215 (4 BBL)	2781153-3385720	1970-72	
	225 (4 BBL)	3385721-4166999	1973-74	
	225-S (4 BBL)	3385721-4166999	1973-74	
	233	4173000-4902304	1975-77	
	255	3258728-4175499	1971-74	

	MOD.	S/N	
GM V8 283, 327, 305 & 350 CID	190	1564539-1730903	1963-64
	898 (2 BBL)	4762210-6218461	1977-82
	898 (2 BBL)	6218462-B525981	1983-84
	200/5.0L (2 BBL)	6218462-F600999	1985-95
	5.0L (2 BBL)	L015751+	1998
	5.0L EFI	L012052-L340000	1998-99
	228 (4 BBL)	4765100-5170008	1977-78
	228 (4 BBL)	5170009-6218461	1979-82
	228 (4 BBL)	6218462-B525981	1982-84
	230 (4 BBL)	6218462-B525981	1985-86
	230/5.0LX (4 BBL)	B525982-F600999	1987-95
	225	1539620-2694014	1963-69
	250	2314301-2639854	1968-69
	255	417550-4767999	1975-76
	250	4768000-4908849	1977
	260/5.7L	4908850-6218461	1978-82
	260/5.7L	621462-B525981	1982-86
	260/5.7L	B525982-F600999	1987-95
	5.7L (2 BBL)	F601000+	1996-98
	5.7L EFI	F225560+	1995
	5.7LX (4 BBL)	F601000-K999999	1996-97
	5.7LX EFI	F752400-K999999	1996-97
	5.7LX BRAVO EFI	F800300-K999999	1996-97
	350 MAG ALPHA	A635178-B525981	1986-87
	350 MAG ALPHA	B525982-F600999	1987-95
	350 MAG ALPHA	F601000-K001526	1996
	350 MAG ALPHA	K001527-K999999	1997
	350 MAG ALPHA EFI	F800300-K999999	1996-97
	350 MAG BRAVO MPI	F415189-K999999	1995-97
	350 MAG BRAVO MPI (GEN+)	F602000-K999999	1996-97
	350 MAG MPI (GEN+)	L010019+	1998
	270	2851074-3385720	1969-72
	280TRS	4176250-4770199	1975-76
	300 TEMPEST	6668677-B430367	1985-86
	320 EFI	A543604-C622418	1987-89
	GM V8 427, 454, 502, 540 & 572 (STERN DRIVE)	325	2278747-3780449
330		4623115-6083144	1977-81
330		6083145-B816450	1982-87
7.4L BRAVO		B771113-D603117	1988-91
7.4L BRAVO (GEN V)		D603118-F800699	1992-96
7.4L BRAVO (GEN VI)		F800700-K999999	1996-97
7.4LX BRAVO (MPI) (GEN V)		F602010-F801999	1996
7.4LX BRAVO (MPI) (GEN VI)		F802000-K999999	1996-97
7.4L MPI (GEN VI)		L010003+	1998
7.4LX BRAVO (TBI) (GEN VI)		F820000-K999999	1996-97
454 MAG ALPHA		A631894+	1986-88
454 MAG BRAVO (GEN V)		D805069-F304999	1992-94
454 MAG BRAVO (GEN V)		F305000-F801699	1995-96
454 MAG BRAVO (GEN VI)		F801700-K999999	1996-97
454 EFI (GEN V)		F115700-F802349	1994-96
454 MAG MPI (GEN VI)		F802350-K999999	1996-97
454 MAG MPI (GEN VI)		L010029-L085399	1998
454 MAG MPI (GEN VI)		L085400+	1999
370 TRS		4179554-6721527	1978-85
370 TRS		6721528-B714586	1985-87
400 TRS		4179554-B457644	1980-86
420		A398941-D937011	1987-89
425		A398941-D937011	1990-93
440 TRS		4179554-B485220	1983-86
450 (GEN V)		F347100-F347277	1995-96
525 SC		D456000-F348963	1991-92
525 SC (GEN V)		D456000-F348963	1992-95
525 SC (GEN V)		F615814-F745215	1996
525 SC (GEN VI)		F745260+	1996-97
390		2781129-3042731	1969-70
460 TRS		4719554-6181046	1983-86
465		C849992-F213244	1990-92
465 (GEN V)		C849992-F213244	1992-94

	MOD.	S/N	
GM V8 427, 454, 502, 540 Et 572 (STERN DRIVE)	500 (GEN V)	F213293-F745159	1994-96
	500 (GEN VI)	F745195-L001772	1997-98
	502 MAG BRAVO	C878221-D824588	1990-92
	502 MAG BRAVO (GEN V)	D824589-F114528	1992-93
	502 EFI (GEN V)	D840650-F802599	1993-96
	502 MAG MPI (GEN VI)	F802600-K999999	1996-97
	500 EFI	L001477+	1999
	502 MAG MPI (GEN VI)	L085433+	1998
	600 SC	D456489-F877642	1991-92
	600 SC (GEN V)	D456489-F877642	1992-96
	600 SC (GEN VI)	K000227+	1997
	500 BULLDOG	C577254-F745405	1990-96
	500 BULLDOG	K000248+	1997
	575	A677429-D763716	1986-92
	800 SC (GEN V)	D763836+	1993-96
MCM 4, 5, 6 Et V8 CYL. DIESEL (STERN DRIVE ENGINE)	ROVER 60HP	3140000F+	1965-67
	530 D-TA 150 HP	B993000-B993492	1989
	636 D-TA 180 HP	B993500-C696047	1989
	D183 140 HP	B993493-D725149	1990-93
	D219 170 HP	C696048-D850124	1990-93
	D254 200 HP	C849484-D554729	1990-93
	D3.0L 140 HP	D725150+	1994
	D3.6L 170 HP	D850125+	1994
	D4.2L 200 HP	D554730+	1994
	D7.3L 238 HP	F060000+	1994
MERCURY MARINE MIE 4 CYL (INBOARD)	470	5520115-6218036	1980-81
	198	4762210-6218461	1977
	228	4765100-5170008	1977-78
	228	5170009-5907057	1978-80
	230/5.0L (4 BBL)	5907058-B788151	1981-87
	225	2278647-2694014	1968
	250	2314301-2639854	1968-69
	255	4175500-5907057	1975-80
	260/5.7L	5907058-F024999	1981-93
	270	2851074-3077735	1969-72
	5.7L	F025000-K999999	1994-97
	5.7L (GEN+)	L002003+	1998
	5.7L MPI	K040300-K999999	1997
	350 MAG MPI (GEN+)	L002008-L304499	1998
	350 MAG MPI (GEN+)	L304500+	1999
GM MIE V8 305, 327, 350 CID (INBOARD)	350 HORIZON	L304700+	1999
	5.7L SKI	A338533-B514626	1985-87
	5.7L COMPETITION SKI	B514627-F775199	1987-95
	5.7L COMPETITION SKI	F775200-K040003	1996
	5.7L COMPETITION SKI	K040004-K999999	1997
	5.7L COMPETITION SKI (GEN+)	L002005+	1998
	350 MAG SKI	D505454-K999999	1991-97
	350 MAG EFI SKI	F215561-K999999	1994-97
	350 MAG MPI SKI	F350583-F799999	1995-98
	BLACK SCORPION SKI	F800000+	1996-98
	325	2278747-3780449	1968-74
	330	4623115-5889913	1977-80
	340/7.4L W/B/W MK4	5889914	1981-92
	7.4L W/HURTH (LH) MK4	C391564-D715493	1989-92
	7.4L (LH)	D715494-K999999	1992-97
7.4L MPI (LH)	F563050-K999999	1995-97	
7.4L MPI (L29) (GEN VI)	L002006+	1998	
7.4L TBI (LH) (GEN VI)	F874815-K999999	1996-97	
GM MIE V8 427, 454, 482 Et 502 CID (INBOARD)	454 MAG MPI HORIZON	L002200-L086049	1998-99
	454 EFI (SKI) (GEN V)	F215800-F820099	1995-96
	454 MAG MPI (SKI) (GEN VI)	F820100-K999999	1996-97
	350	9780450-4623109	1974-76
	390	2781129-2825059	1969-70
	8.2L W/HURTH	C878221-D857199	1990-92
	8.2L (GEN V)	D857200-F819619	1993-96
	8.2L MPI (LH) (GEN VI)	F819620-K999999	1996-97
	8.2L MPI (LH) (GEN VI)	L002450-L0086012	1998
	8.2L MPI (LH) (GEN VI)	L0086013+	1999

	MOD.	S/N	
FORD MIE V8 (INBOARD)	215	2781153-3563181	1970-72
	225	3385721-4176999	1970-72
	233	4173000-4775784	1975-76
	255	3258728-4178299	1973-74
MIE 5, 6 Et V8 CYL. DIESEL INBOARD ENGINES	530 D-TA 150 HP	B993002-C539258	1989
	636 D-TA 180 HP	B993750-C696011	1989
	D183 150 HP	C539259-D725149	1990-93
	D219 180 HP	C696012-D850124	1990-93
	D254 210 HP	C849461-D554729	1990-93
	D3.0L 150 HP	D725150+	1994
	D3.6L 180 HP	D850125+	1994
D4.2L 210 HP	D554730+	1994	
D7.3L 262 HP	F060000+	1994	
MC 60, 80 Et 90 STERN DRIVES Et TRANSOM PLATES	60 (O)	1830753-2063740	1965-66
	80	2063741-2898029	1966-69
	90	2898020-3225967	1970-72
MC I, II Et III	I	1534570-1684187	1963
	II (1.33:1)	1474909-2278488	1962-67
	II (1.78:1)	2398798-2671321	1968-69
	III	2373127-3002613	1968-72
MC 1A, 1B Et 1C	III	5128065	1978
	1A, 1B Et 1C	1684188-1777798	1964
MC 120, 140, 160 Et 165	1A, 1B Et 1C (E-Z SHIFT)	1776349-2065189	1965-66
	120/140	2062141-378049	1967-73
	120/140	3780850-4893634	1974-77
	120/140	4893635-6225576	1978-82
	160	2065190-2763441	1967-69
	165	2763442-3780849	1970-73
	165	3780849-4890459	1974-77
	165	4890460-6268064	1978-82
	470	4208730-4893830	1976-77
	470 Et 485	470	4893835-6225576
MC 470 Et 485	485	5487437-6225576	1980-82
	888	3106717-3784374	1971-73
	888	3784375-4782329	1974-77
MC 488, 225S Et 233	225S	3856268-4200499	1974
	233	4200500-4782329	1975-77
MC 898, 228, 250 Et 260	898/228	4782330-4898729	1977
	898/228	4898730-6229157	1978-82
	250	4791300-4898729	1977
MC R, MR, ALPHA ONE, ALPHA ONE SS Et ALPHA ONE GEN II	260	4898730-6229157	1978-82
	R	6152230-6847029	1983-84
	MR	6810538-A479506	1985
	ALPHA ONE	A470165+	1986-90
	ALPHA ONE SS	A545004+	1986-89
MC BRAVO Et BLACKHAWK	ALPHA ONE GEN II	D469859+	1991
	BRAVO ONE	B664190+	1988
	BRAVO TWO	C564952+	1989
	BRAVO THREE	D763691+	1993
MC 215E Et 215 H	BLACKHAWK	F186717+	1994
	215 H	2782203-2909034	1970
	215 E	2782203-2909034	1970-72
MC TR Et TRS	TR	3377316-3787239	1973
	TR	3787240-4794899	1974-76
	TR	4794900-5009866	1977
	TR	5009867	1978
	TRS	3787240-4203749	1974-75
	TRS	4203750-4795399	1976
TRS	4795400	1977	



GUÍA  
MANTENIMIENTO DE  
MOTORES

ENGIEN MAINTENANCE  
GUIDE

GUIDA  
MANUTENZIONE  
MOTORI

GUIDE  
MAINTENANCE  
MOTEURS



	REF					UN.	
3.0L GM181 I/L4 1987+ (0B450801+)	NGKBR6FS	(-0L096999)	BUJIA	SPARK PLUG	CANDELE	BOUGIE	4
	NGKBPR6EFS	(0L097000+)	BUJIA	SPARK PLUG	CANDELE	BOUGIE	4
	REC3852106	(-0L382121)	CORREA ALTERNADOR	ALTERNATOR BELT	CINGHIA ALTERNATORE	COURROIE ALTERNATEUR	1
	RM57-862054Q	(0L382122+)	CORREA ALTERNADOR (dirección hidráulica)	ALTERNATOR BELT (hydraulic steering)	CINGHIA ALTERNATORE (sterzo idraulico)	COURROIE ALTERNATEUR (direction hydraulique)	1
	REC57-49043A1		CORREA ALTERNADOR (sin dirección hidráulica)	ALTERNATOR BELT (without hydraulic steering)	CINGHIA ALTERNATORE (senza sterzo idraulico)	COURROIE ALTERNATEUR (sans direction hydraulique)	1
	REC57-65607Q		CORREA DIRECCIÓN HIDRAULICA	HYDRAULIC STEERING BELT	CINGHIA STERZO IDRAULICO	COURROIE DIRECTION HYDRAULIQUE	1
	REC59078Q3	(-0L340999)	TERMOSTATO	THERMOSTAT	TERMOSTATO	THERMOSTAT	1
	REC8M0091470	(0L341000+)	TERMOSTATO (Enfriador cerrado)	THERMOSTAT (closed cooling)	TERMOSTATO (raffreddamento chiuso)	THERMOSTAT (refroidisseur fermé)	1
	REC35-06003		FILTRO ACEITE	OIL FILTER	FILTRO OLIO	FILTRE D'HUILE	1
	REC25W40U3		ACEITE MOTOR	OIL	OLIO MOTORE	HUILE MOTEUR	1
3.0LX GM181 I/L4 (1990-1997) (0C856569 - 0K999999)	NGKBR6FS	(-0F603999)	BUJIA	SPARK PLUG	CANDELE	BOUGIE	4
	NGKBPR6EFS	(0F604000+)	BUJIA	SPARK PLUG	CANDELE	BOUGIE	4
	REC57-49043A1		CORREA ALTERNADOR (1 polea grove)	ALTERNATOR BELT (1 grove pulley)	CINGHIA ALTERNATORE (1 puleggia grove)	COURROIE ALTERNATEUR (1 poulie grove)	1
	REC3852106		CORREA ALTERNADOR (3 poleas grove)	ALTERNATOR BELT (3 grove pulley)	CINGHIA ALTERNATORE (3 puleggia grove)	COURROIE ALTERNATEUR (3 poulies grove)	1
	REC59078Q3		TERMOSTATO	THERMOSTAT	TERMOSTATO	THERMOSTAT	1
	REC8M0091470		TERMOSTATO (Enfriador cerrado)	THERMOSTAT (closed cooling)	TERMOSTATO (raffreddamento chiuso)	THERMOSTAT (refroidisseur fermé)	1
	REC57-65607Q		FILTRO ACEITE	OIL FILTER	FILTRO OLIO	FILTRE D'HUILE	1
	REC35-06003		FILTRO ACEITE	OIL FILTER	FILTRO OLIO	FILTRE D'HUILE	1
	REC25W40U3		ACEITE MOTOR	OIL	OLIO MOTORE	HUILE MOTEUR	1
	3.0 MPI EC (1A072812+)	NGKTR6IX		BUJIA	SPARK PLUG	CANDELE	BOUGIE
RM57-862054Q			CORREA ALTERNADOR	ALTERNATOR BELT	CINGHIA ALTERNATORE	COURROIE ALTERNATEUR	1
REC8M0091470			TERMOSTATO	THERMOSTAT	TERMOSTATO	THERMOSTAT	1
REC57-65607Q			CORREA DIRECCIÓN HIDRAULICA (940 mm)	HYDRAULIC STEERING BELT (940 mm)	CINGHIA STERZO IDRAULICO (940 mm)	COURROIE DIRECTION HYDRAULIQUE (940 mm)	1
REC35-06003			FILTRO ACEITE	OIL FILTER	FILTRO OLIO	FILTRE D'HUILE	1
RM35-866594Q01			FILTRO GASOLINA	FUEL FILTER	FILTRO BENZINA	FILTRE ESSENCE	1
REC25W40U3			ACEITE MOTOR	OIL	OLIO MOTORE	HUILE MOTEUR	1
3.0L TKS Plus (1G404114)	NGKBPR6EFS		BUJIA	SPARK PLUG	CANDELE	BOUGIE	4
	RM57-862054Q		CORREA ALTERNADOR	ALTERNATOR BELT	CINGHIA ALTERNATORE	COURROIE ALTERNATEUR	1
	REC8M0091470		TERMOSTATO	THERMOSTAT	TERMOSTATO	THERMOSTAT	1
	REC35-06003		FILTRO ACEITE	OIL FILTER	FILTRO OLIO	FILTRE D'HUILE	1
	REC25W40U3		ACEITE MOTOR	OIL	OLIO MOTORE	HUILE MOTEUR	1
	REC35-06003		FILTRO ACEITE	OIL FILTER	FILTRO OLIO	FILTRE D'HUILE	1
4.3L (GEN II) (1992-96) (0D714107 - 0F802999)	NGKBR6FS		BUJIA	SPARK PLUG	CANDELE	BOUGIE	6
	REC829207		CORREA ALTERNADOR (46")	ALTERNATOR BELT (46")	CINGHIA ALTERN. (46")	COURROIE ALTERN. (46")	1
	REC57-816295Q		CORREA DIRECCION HIDRAULICA	HYDRAULIC STEERING BELT	CINGHIA STERZO IDRAULICO	COURROIE DIRECTION HYDRAULIQUE	1
	REC8M0089715		TERMOSTATO 140°	THERMOSTAT 140°	TERMOSTATO 140°	THERMOSTAT 140°	1
	REC8M0091470		TERMOSTATO 160°	THERMOSTAT 160°	TERMOSTATO 160°	THERMOSTAT 160°	1
	REC35-06004		FILTRO ACEITE	OIL FILTER	FILTRO OLIO	FILTRE D'HUILE	1
	REC35-06003		FILTRO ACEITE (filtro remoto)	OIL FILTER (remote filter)	FILTRO OLIO (filtro remoto)	FILTRE D'HUILE (filter à distance)	1
	REC35-802893Q01		FILTRO GASOLINA	FUEL FILTER	FILTRO BENZINA	FILTRE D'ESSENCE	1
	REC25W40U3		ACEITE MOTOR	OIL	OLIO MOTORE	HUILE MOTEUR	2
	4.3L & LX (GEN +) (1996-98) (0F803000 - 0M614999)	NGKBR6FS		BUJIA	SPARK PLUG	CANDELE	BOUGIE
REC8M0089715			TERMOSTATO 140°	THERMOSTAT 140°	TERMOSTATO 140°	THERMOSTAT 140°	1
REC8M0091470			TERMOSTATO 160°	THERMOSTAT 160°	TERMOSTATO 160°	THERMOSTAT 160°	1
REC35-06004			FILTRO ACEITE	OIL FILTER	FILTRO OLIO	FILTRE D'HUILE	1
REC35-06003			FILTRO ACEITE (filtro remoto)	OIL FILTER (remote filter)	FILTRO OLIO (filtro remoto)	FILTRE D'HUILE (filter à distance)	1
REC35-802893Q			FILTRO GASOLINA	FUEL FILTER	FILTRO BENZINA	FILTRE D'ESSENCE	1
REC47-59362Q01		BRAVO	IMPULSOR	IMPELLER	GIRANTE	TURBINE	1
REC25W40U3			ACEITE MOTOR	OIL	OLIO MOTORE	HUILE MOTEUR	1
4.3L CARB. ALPHA/ BRAVO (0M61500+)	NGKBPR6EFS		BUJIA	SPARK PLUG	CANDELE	BOUGIE	6
	REC8M0089715		TERMOSTATO 140°	THERMOSTAT 140°	TERMOSTATO 140°	THERMOSTAT 140°	1
	REC8M0091470		TERMOSTATO 160°	THERMOSTAT 160°	TERMOSTATO 160°	THERMOSTAT 160°	1
	REC864493		TERMOSTATO 170° (enfriador cerrado)	THERMOSTAT 170° (closed cooling)	TERMOSTATO 170° (raffreddamento chiuso)	THERMOSTAT 170° (refroidisseur fermé)	1
	REC35-06004		FILTRO ACEITE	OIL FILTER	FILTRO OLIO	FILTRE D'HUILE	1
	REC35-06003		FILTRO ACEITE (filtro remoto)	OIL FILTER (remote filter)	FILTRO OLIO (filtro remoto)	FILTRE D'HUILE (filter à distance)	1
	REC35-802893Q01		FILTRO GASOLINA	FUEL FILTER	FILTRO BENZINA	FILTRE D'ESSENCE	1
	REC47-59362Q01	BRAVO	IMPPELLER STD (enfriador)	IMPELLER STD (cooling)	GIRANTE STD (raffreddamento)	TURBINE STD (refroidisseur)	1
	REC47-862232A2	BRAVO	IMPPELLER (enfriador cerrado)	IMPELLER (closed cooling)	GIRANTE (raffreddamento chiuso)	TURBINE (refroidisseur fermé)	1
	REC57-865615Q04	ALPHA	CORREA (dirección asistida)	BELT (power steering)	CINGHIA (servosterzo)	COURROIE (direction assistée)	1
	REC57-865615Q03	BRAVO	CORREA (dirección asistida)	BELT (power steering)	CINGHIA (servosterzo)	COURROIE (direction assistée)	1
	REC57-865615Q08	BRAVO	CORREA (dirección hidráulica compacta)	BELT (compact hydraulic steering)	CINGHIA (sterzo idraulico compatto)	COURROIE (direction hydraulique compacte)	1
	REC25W40U3		ACEITE MOTOR	OIL	OLIO MOTORE	HUILE MOTEUR	2







REF

UN.

4.3L EFI (GEN+) TBI (0L619000- 0L618999)	NGKBPR6EFS	BUJIA	SPARK PLUG	CANDELE	BOUGIE		
	REC8M0089715	TERMOSTATO 140°	THERMOSTAT 140°	TERMOSTATO 140°	THERMOSTAT 140°		
	REC8M0091470	TERMOSTATO 160°	THERMOSTAT 160°	TERMOSTATO 160°	THERMOSTAT 160°		
	REC35-06004	FILTRO ACEITE	OIL FILTER	FILTRO OLIO	FILTRE D'HUILE		
	REC35-06003	FILTRO ACEITE (filtro remoto)	OIL FILTER (remote filter)	FILTRO OLIO (filtro remoto)	FILTRE D'HUILE (filtre à distance)		
	REC35-802893Q01	FILTRO GASOLINA	FUEL FILTER	FILTRO BENZINA	FILTRE D'ESSENCE		
	REC47-59362Q01	IMPULSOR	IMPELLER	GIRANTE	TURBINE		
	REC25W40U3	ACEITE MOTOR	OIL	OLIO MOTORE	HUILE MOTEUR		
	194	CORREAS	BELT	CINGHIE	COURROIES		
4.3L MPI ALPHA/ BRAVO & EC MODELS (ALL SERIES) (0M300000+)	NGKTR6IX	BUJIA	SPARK PLUG	CANDELE	BOUGIE	6	
	REC8M0089715	TERMOSTATO 140°	THERMOSTAT 140°	TERMOSTATO 140°	THERMOSTAT 140°	1	
	REC8M0091470	TERMOSTATO 160°	THERMOSTAT 160°	TERMOSTATO 160°	THERMOSTAT 160°	1	
	REC864493	TERMOSTATO 170° (enfriador cerrado)	THERMOSTAT 170° (closed cooling)	TERMOSTATO 170° (raffreddamento chiuso)	THERMOSTAT 170° (refroidisseur fermé)	1	
	REC35-06004	FILTRO ACEITE	OIL FILTER	FILTRO OLIO	FILTRE D'HUILE	1	
	REC35-06003	FILTRO ACEITE (filtro remoto)	OIL FILTER (remote filter)	FILTRO OLIO (filtro remoto)	FILTRE D'HUILE (filtre à distance)	1	
	REC35-802893Q01	FILTRO GASOLINA	FUEL FILTER	FILTRO BENZINA	FILTRE D'ESSENCE	1	
	REC47-862232A2	IMPULSOR	IMPELLER	GIRANTE	TURBINE	1	
REC25W40U3	ACEITE MOTOR	OIL	OLIO MOTORE	HUILE MOTEUR	2		
	194	CORREAS	BELT	CINGHIE	COURROIES		
4.5L MPI ALPHA/ BRAVO (2A441953+)	NGKBPR5EFS-13	BUJIA	SPARK PLUG	CANDELE	BOUGIE	6	
	REC864493	TERMOSTATO 170° (intercambiador de calor)	THERMOSTAT 170° (heat exchanger)	TERMOSTATO 170° (scambiatore di calore)	THERMOSTAT 170° (échangeur de chaleur)	1	
	REC8M0089715	TERMOSTATO 140°	THERMOSTAT 140°	TERMOSTATO 140°	THERMOSTAT 140°	1	
	REC35-06003	FILTRO ACEITE	OIL FILTER	FILTRO OLIO	FILTRE D'HUILE	1	
	RAC31871	FILTRO GASOLINA	FUEL FILTER	FILTRO BENZINA	FILTRE D'ESSENCE	1	
	REC47-862232A2	IMPULSOR	IMPELLER	GIRANTE	TURBINE	1	
	REC25W40U3	ACEITE MOTOR	OIL	OLIO MOTORE	HUILE MOTEUR	2	
		194	CORREAS	BELT	CINGHIE	COURROIES	
5.0L (1988-95) (0B774445 - 0F600999)	NGKBR6FS	BUJIA	SPARK PLUG	CANDELE	BOUGIE	8	
	REC8M0089715	TERMOSTATO 140°	THERMOSTAT 140°	TERMOSTATO 140°	THERMOSTAT 140°	1	
	REC8M0091470	TERMOSTATO 160°	THERMOSTAT 160°	TERMOSTATO 160°	THERMOSTAT 160°	1	
	REC35-06003	FILTRO ACEITE	OIL FILTER	FILTRO OLIO	FILTRE D'HUILE	1	
	REC35-802893Q01	FILTRO GASOLINA	FUEL FILTER	FILTRO BENZINA	FILTRE D'ESSENCE	1	
	REC47-59362Q01	IMPULSOR (enfriador cerrado)	IMPELLER (closed cooling)	GIRANTE (raffreddamento chiuso)	TUBINE (refroidisseur fermé)	1	
	REC57-13457Q	CORREA BOMBA DE AGUA	WATER PUMP BELT	CINGHIA POMPA DELL'ACQUA	COURROIE POMPE D'EAU	1	
	REC57-34359	CORREA (dirección hidráulica)	BELT (hydraulic steering)	CINGHIA (sterzo idraulico)	COURROIE (direction hydraulique)	1	
	REC3858462	CORREA ALTERN. (44")	ALTERNATOR BELT (44")	CINGHIA ALTERN. (44")	COURROIE ALTERN. (44")	1	
	REC829207	CORREA ALTERN. (46")	ALTERNATOR BELT (46")	CINGHIA ALTERN. (46")	COURROIE ALTERN. (46")	1	
	REC25W40U3	ACEITE MOTOR	OIL	OLIO MOTORE	HUILE MOTEUR	2	
		194	CORREAS	BELT	CINGHIE	COURROIES	
5.0L & 5.0L EFI (1998-01) (0L015751 - 0M599999)	NGKBPR6EFS	BUJIA	SPARK PLUG	CANDELE	BOUGIE	8	
	REC8M0089715	TERMOSTATO 140°	THERMOSTAT 140°	TERMOSTATO 140°	THERMOSTAT 140°	1	
	REC8M0091470	TERMOSTATO 160°	THERMOSTAT 160°	TERMOSTATO 160°	THERMOSTAT 160°	1	
	REC99155T2	TERMOSTATO 170° (enfriador cerrado)	THERMOSTAT 170° (closed cooling)	TERMOSTATO 170° (raffreddamento chiuso)	THERMOSTAT 170° (refroidisseur fermé)	1	
	REC35-06003	FILTRO ACEITE	OIL FILTER	FILTRO OLIO	FILTRE D'HUILE	1	
	REC35-802893Q01	FILTRO GASOLINA	FUEL FILTER	FILTRO BENZINA	FILTRE D'ESSENCE	1	
	REC47-59362Q01	IMPULSOR	IMPELLER	GIRANTE	TURBINE	1	
	REC25W40U3	ACEITE MOTOR	OIL	OLIO MOTORE	HUILE MOTEUR	2	
		194	CORREAS	BELT	CINGHIE	COURROIES	
	5.0L CARB. ALPHA/ BRAVO (0M600000+)	NGKBPR6EFS	BUJIA	SPARK PLUG	CANDELE	BOUGIE	8
		REC8M0089715	TERMOSTATO 140°	THERMOSTAT 140°	TERMOSTATO 140°	THERMOSTAT 140°	1
		REC8M0091470	TERMOSTATO 160°	THERMOSTAT 160°	TERMOSTATO 160°	THERMOSTAT 160°	1
REC35-06003		FILTRO ACEITE	OIL FILTER	FILTRO OLIO	FILTRE D'HUILE	1	
REC35-802893Q		FILTRO GASOLINA	FUEL FILTER	FILTRO BENZINA	FILTRE D'ESSENCE	1	
REC47-59362Q01		IMPULSOR	IMPELLER	GIRANTE	TURBINE	1	
REC57-865615Q04		CORREA (dirección asistida)	BELT (power steering)	CINGHIA (servosterzo)	COURROIE (direction assistée)	1	
REC57-865615Q03		CORREA (dirección asistida)	BELT (power steering)	CINGHIA (servosterzo)	COURROIE (direction assistée)	1	
REC57-865615Q08	CORREA (sin dirección asistida)	BELT (without power steering)	CINGHIA (senza servosterzo)	COURROIE (sans direction assistée)	1		
REC25W40U3	ACEITE MOTOR	OIL	OLIO MOTORE	HUILE MOTEUR	2		
	194	CORREAS	BELT	CINGHIE	COURROIES		
5.0L MPI ALPHA/ BRAVO & EC (0M300000+)	NGKITR4A15	BUJIA	SPARK PLUG	CANDELE	BOUGIE	8	
	REC8M0089715	TERMOSTATO 140°	THERMOSTAT 140°	TERMOSTATO 140°	THERMOSTAT 140°	1	
	REC8M0091470	TERMOSTATO 160°	THERMOSTAT 160°	TERMOSTATO 160°	THERMOSTAT 160°	1	
	REC99155T2	TERMOSTATO 160° (drenaje fácil)	THERMOSTAT 160° (easy drain)	TERMOSTATO 160° (scarico facile)	THERMOSTAT 160° (vidange facile)	1	
	REC864493	TERMOSTATO 170° (drenaje fácil)	THERMOSTAT 170° (easy drain)	TERMOSTATO 170° (scarico facile)	THERMOSTAT 170° (vidange facile)	1	
	REC35-06003	FILTRO ACEITE	OIL FILTER	FILTRO OLIO	FILTRE D'HUILE	1	
	REC35-802893Q	FILTRO GASOLINA	FUEL FILTER	FILTRO BENZINA	FILTRE D'ESSENCE	1	
	REC35-866171A01	FILTRO GASOLINA (módulo gasolina)	FUEL FILTER (fuel module)	FILTRO BENZINA (modulo benzina)	FILTRE D'ESSENCE (module à essence)	1	
	REC35-892665	FILTRO GASOLINA (módulo gasolina)	FUEL FILTER (fuel module)	FILTRO BENZINA (modulo benzina)	FILTRE D'ESSENCE (module à essence)	1	
	REC47-862232A2	IMPULSOR	IMPELLER	GIRANTE	TURBINE	1	
	REC25W40U3	ACEITE MOTOR	OIL	OLIO MOTORE	HUILE MOTEUR	2	
		194	CORREAS	BELT	CINGHIE	COURROIES	

	REF					UN.
5.7L CARB. ALPHA/ BRAVO & LX/ EFI (1998+) (OB525982 +)	NGKBR6EFS (-OK999999)	BUJIA	SPARK PLUG	CANDELE	BOUGIE	8
	NGKBR6EFS (OL010037+)	BUJIA	SPARK PLUG	CANDELE	BOUGIE	8
	REC8M0089715	TERMOSTATO 140°	THERMOSTAT 140°	TERMOSTATO 140°	THERMOSTAT 140°	1
	REC8M0091470	TERMOSTATO 160°	THERMOSTAT 160°	TERMOSTATO 160°	THERMOSTAT 160°	1
	REC99155T2	TERMOSTATO (enfriador cerrado)	THERMOSTAT (closed cooling)	TERMOSTATO (raffreddamento chiuso)	THERMOSTAT (refroidisseur fermé)	1
	REC35-06003	FILTRO ACEITE	OIL FILTER	FILTRO OLIO	FILTRE D'HUILE	1
	REC35-802893Q	FILTRO GASOLINA	FUEL FILTER	FILTRO BENZINA	FILTRE D'ESSENCE	1
	REC47-59362Q01 BRAVO	IMPULSOR	IMPELLER	GIRANTE	TURBINE	1
	REC25W40U3	ACEITE MOTOR	OIL	OLIO MOTORE	HUILE MOTEUR	2
		CORREAS	BELT	CINGHIE	COURROIES	
350 MAG & 350 MAG EFI (GEN+) (1986+) (OA635178 - OK999999)	NGKBR6FS	BUJIA	SPARK PLUG	CANDELE	BOUGIE	8
	NGKBR6EFS EFI	BUJIA	SPARK PLUG	CANDELE	BOUGIE	8
	REC35-802893Q	FILTRO GASOLINA	FUEL FILTER	FILTRO BENZINA	FILTRE D'ESSENCE	1
	REC65L-13915-00 EFI	FILTRO GASOLINA VST	FUEL FILTER VST	FILTRO BENZINA VST	FILTRE D'ESSENCE VST	1
	REC35-06003	FILTRO ACEITE	OIL FILTER	FILTRO OLIO	FILTRE D'HUILE	1
	REC8M0089715	TERMOSTATO 140°	THERMOSTAT 140°	TERMOSTATO 140°	THERMOSTAT 140°	1
	REC8M0091470	TERMOSTATO 160°	THERMOSTAT 160°	TERMOSTATO 160°	THERMOSTAT 160°	1
	REC47-59362Q01 BRAVO	IMPULSOR	IMPELLER	GIRANTE	TURBINE	1
	REC25W40U3	ACEITE MOTOR	OIL	OLIO MOTORE	HUILE MOTEUR	2
		CORREAS	BELT	CINGHIE	COURROIES	
350 MAG/MPI (OF415189+)	NGKBR6EFS (-OF601999)	BUJIA	SPARK PLUG	CANDELE	BOUGIE	8
	NGKTR6IX (OF602000 - OM299999)	BUJIA	SPARK PLUG	CANDELE	BOUGIE	8
	NGKITR4A15 (OM300000+)	BUJIA	SPARK PLUG	CANDELE	BOUGIE	8
	REC35-802893Q	FILTRO GASOLINA	FUEL FILTER	FILTRO BENZINA	FILTRE D'ESSENCE	1
	REC65L-13915-00 (-OM299999)	FILTRO GASOLINA VST	FUEL FILTER VST	FILTRO BENZINA VST	FILTRE D'ESSENCE VST	1
	REC864572 (OM300000 - OW059999)	FILTRO GASOLINA IN-LINE	FUEL FILTRO IN-LINE	FILTRO BENZINA IN-LINE	FILTRE D'ESSENCE IN-LINE	1
	REC35-866171A01 (OW060000+)	FILTRO GASOLINA VST	FUEL FILTER VST	FILTRO BENZINA VST	FILTRE D'ESSENCE VST	1
	REC35-892665 (OW060000+)	FILTRO GASOLINA VST	FUEL FILTER VST	FILTRO BENZINA VST	FILTRE D'ESSENCE VST	1
	REC35-06003	FILTRO ACEITE	OIL FILTER	FILTRO OLIO	FILTRE À HUILE	1
	REC47-59362Q01 BRAVO (-OM299999)	IMPULSOR	IMPELLER	GIRANTE	TURBINE	1
	REC47-862232A2 (OM300000+)	IMPULSOR	IMPELLER	GIRANTE	TURBINE	1
	REC8M0089715	TERMOSTATO 140°	THERMOSTAT 140°	TERMOSTATO 140°	THERMOSTAT 140°	1
	REC8M0091470	TERMOSTATO 160°	THERMOSTAT 160°	TERMOSTATO 160°	THERMOSTAT 160°	1
	REC99155T2	TERMOSTATO 160° (drenaje fácil y enfriador cerrado)	THERMOSTAT 160° (easy drain & closing cooling)	TERMOSTATO 160° (scarico facile e raffreddamento chiuso)	THERMOSTAT 160° (vidange facile et refroidisseur fermé)	1
	REC25W40U3	ACEITE MOTOR	OIL	OLIO MOTORE	HUILE MOTEUR	2
		CORREAS	BELT	CINGHIE	COURROIES	
	6.2L MPI & 377 MAG MPI (OL302200+)	NGKTR6IX (OL302200 - OM299999)	BUJIA	SPARK PLUG	CANDELE	BOUGIE
NGKITR4A15 (OM310000+)		BUJIA	SPARK PLUG	CANDELE	BOUGIE	8
NGKITR4A15 (OM300000+)		BUJIA	SPARK PLUG	CANDELE	BOUGIE	8
REC35-802893Q		FILTRO GASOLINA	FUEL FILTER	FILTRO BENZINA	FILTRE D'ESSENCE	1
REC864572 (OM311053+)		FILTRO GASOLINA IN-LINE	FUEL FILTRO IN-LINE	FILTRO BENZINA IN-LINE	FILTRE D'ESSENCE IN-LINE	1
REC35-866171A01 (OM398395+)		FILTRO GASOLINA VST	FUEL FILTER VST	FILTRO BENZINA VST	FILTRE D'ESSENCE VST	1
REC35-892665 (OM398395+)		FILTRO GASOLINA VST	FUEL FILTER VST	FILTRO BENZINA VST	FILTRE D'ESSENCE VST	1
REC35-06003		FILTRO ACEITE	OIL FILTER	FILTRO OLIO	FILTRE À HUILE	1
REC016940 HURT/ZEUS		FILTRO ACEITE TRANSMISION	OIL FILTER TRANSMISSION	FILTRO OLIO TRASMISSIONE	FILTRE À HUILE DE TRANSMISSION	1
REC47-59362Q01 (OL302200 - OM299999)		IMPULSOR	IMPELLER	GIRANTE	TURBINE	1
REC47-862232A2 (OM310000+)		IMPULSOR	IMPELLER	GIRANTE	TURBINE	1
REC8M0089715		TERMOSTATO 140°	THERMOSTAT 140°	TERMOSTATO 140°	THERMOSTAT 140°	1
REC8M0091470		TERMOSTATO 160°	THERMOSTAT 160°	TERMOSTATO 160°	THERMOSTAT 160°	1
REC99155T2 (-OM316999)		TERMOSTATO (drenaje fácil y enfriador cerrado)	THERMOSTAT (easy drain & closing cooling)	TERMOSTATO (scarico facile e raffreddamento chiuso)	THERMOSTAT (vidange facile et refroidisseur fermé)	1
REC864493 (OM317000+)		TERMOSTATO (drenaje fácil y enfriador cerrado)	THERMOSTAT (easy drain & closing cooling)	TERMOSTATO (scarico facile e raffreddamento chiuso)	THERMOSTAT (vidange facile et refroidisseur fermé)	1
REC25W40U3		ACEITE MOTOR	OIL	OLIO MOTORE	HUILE MOTEUR	2
		CORREAS	BELT	CINGHIE	COURROIES	
(1988+) (GEN V&VI) (OM771113 - OM024330)	NGKBR6FS (OK999999-)	BUJIA	SPARK PLUG	CANDELE	BOUGIE	8
	NGKBR6EFS (OL010003 - OM024330)	BUJIA	SPARK PLUG	CANDELE	BOUGIE	8
	NGKBR6FVX MPI HORIZON	BUJIA	SPARK PLUG	CANDELE	BOUGIE	8
	REC35-802893Q	FILTRO GASOLINA	FUEL FILTER	FILTRO BENZINA	FILTRE D'ESSENCE	1
	REC65L-13915-00 (OF602010+)	FILTRO GASOLINA VST	FUEL FILTER VST	FILTRO BENZINA VST	FILTRE D'ESSENCE VST	1
	REC35-06003	FILTRO ACEITE	OIL FILTER	FILTRO OLIO	FILTRE À HUILE	1
	REC016940 HURT/ZEUS	FILTRO ACEITE TRANSMISION	OIL FILTER TRANSMISSION	FILTRO OLIO TRASMISSIONE	FILTRE À HUILE DE TRANSMISSION	1
	REC47-59362Q01	IMPULSOR	IMPELLER	GIRANTE	TURBINE	1
	REC8M0089715	TERMOSTATO 140°	THERMOSTAT 140°	TERMOSTATO 140°	THERMOSTAT 140°	1
	REC8M0091470	TERMOSTATO 160°	THERMOSTAT 160°	TERMOSTATO 160°	THERMOSTAT 160°	1
	REC99155T2	TERMOSTATO (drenaje fácil y enfriador cerrado)	THERMOSTAT (easy drain & closing cooling)	TERMOSTATO (scarico facile e raffreddamento chiuso)	THERMOSTAT (vidange facile et refroidisseur fermé)	1
	REC25W40U3	ACEITE MOTOR	OIL	OLIO MOTORE	HUILE MOTEUR	2
		CORREAS	BELT	CINGHIE	COURROIES	



	REF					UN.	
8.1L (0M0206000+)	NGKTR55IX	(-2006)	BUJIA	SPARK PLUG	CANDELE	BOUGIE	8
	NGKIZFR7M	(2007+)	BUJIA	SPARK PLUG	CANDELE	BOUGIE	8
	REC35-802893Q		FILTRO GASOLINA	FUEL FILTER	FILTRO BENZINA	FILTRE D'ESSENCE	1
	REC35-866171A01		FILTRO GASOLINA VST	FUEL FILTER VST	FILTRO BENZINA VST	FILTRE D'ESSENCE VST	1
	REC35-892665		FILTRO GASOLINA VST	FUEL FILTER VST	FILTRO BENZINA VST	FILTRE D'ESSENCE VST	1
	REC35-06003		FILTRO ACEITE	OIL FILTER	FILTRO OLIO	FILTRE À HUILE	1
	REC016940	HURT/ZEUS	FILTRO ACEITE TRANSMISION	OIL FILTER TRANSMISSION	FILTRO OLIO TRASMISSIONE	FILTRE À HUILE DE TRANSMISSION	1
	REC47-862232A2		IMPULSOR	IMPELLER	GIRANTE	TURBINE	1
	REC25W40U3		ACEITE MOTOR	OIL	OLIO MOTORE	HUILE MOTEUR	3
			CORREAS	BELT	CINGHIE	COURROIES	
8.2L (1A350802 - 2A041665)	NGKBPR6ES		BUJIA	SPARK PLUG	CANDELE	BOUGIE	8
	REC35-802893Q		FILTRO GASOLINA	FUEL FILTER	FILTRO BENZINA	FILTRE D'ESSENCE	1
	REC35-866171A01		FILTRO GASOLINA VST	FUEL FILTER VST	FILTRO BENZINA VST	FILTRE D'ESSENCE VST	1
	REC35-892665		FILTRO GASOLINA VST	FUEL FILTER VST	FILTRO BENZINA VST	FILTRE D'ESSENCE VST	1
	REC35-06003		FILTRO ACEITE	OIL FILTER	FILTRO OLIO	FILTRE À HUILE	1
	REC016940	HURT/ZEUS	FILTRO ACEITE TRANSMISION	OIL FILTER TRANSMISSION	FILTRO OLIO TRASMISSIONE	FILTRE À HUILE DE TRANSMISSION	1
	REC47-862232A2		IMPULSOR	IMPELLER	GIRANTE	TURBINE	1
	REC25W40U3		ACEITE MOTOR	OIL	OLIO MOTORE	HUILE MOTEUR	3
			CORREAS	BELT	CINGHIE	COURROIES	



	REF					UN.	
QSD 2.0 DIESEL	REC35-879172143		FILTRO AIRE	AIR FILTER	FILTRO ARIA	FILTRE D'AIR	
	REC35-879172104		FILTRO COMBUSTIBLE	DIESEL FILTER	FILTRO COMBUSTIBILE	FILTRE CARBURANT	
	REC879150054		TERMOSTATO	THERMOSTAT	TERMOSTATO	THERMOSTAT	
	REC57-879172120		CORREA	BELT	CINGHIE	COURROIE	
	TEN01320T		ANODO	ANODE	ANODO	ANODE	
	REC895207		FILTRO ACEITE (83mm)	OIL FILTER (83 mm)	FILTRO OLIO (83 mm)	FILTRE À HUILE (83 mm)	
	REC35-879312041		FILTRO ACEITE (67mm)	OIL FILTER (67 mm)	FILTRO OLIO (67 mm)	FILTRE À HUILE (67 mm)	
	REC15W40U3		ACEITE MOTOR	OIL	OLIO MOTORE	HUILE MOTEUR	
	JAB11979-0001	JABSCO	IMPULSOR	IMPELLER	GIRANTE	TURBINE	
	SHE10615K	SHERWOOD	IMPULSOR	IMPELLER	GIRANTE	TURBINE	
QSD 2.8 DIESEL	REC879172		FILTRO AIRE	AIR FILTER	FILTRO ARIA	FILTRE D'AIR	
	REC35-879172104		FILTRO COMBUSTIBLE	DIESEL FILTER	FILTRO COMBUSTIBILE	FILTRE CARBURANT	
	REC8M0093561		TERMOSTATO	THERMOSTAT	TERMOSTATO	THERMOSTAT	
	REC57-879194425		CORREA	BELT	CINGHIE	COURROIE	
	TEN01320T		ANODO	ANODE	ANODO	ANODE	
	REC895207		FILTRO ACEITE	OIL FILTER	FILTRO OLIO	FILTRE À HUILE	
	REC15W40U3		ACEITE MOTOR	OIL	OLIO MOTORE	HUILE MOTEUR	
	JAB11979-0001	JABSCO	IMPULSOR	IMPELLER	GIRANTE	TURBINE	
	SHE10615K	SHERWOOD	IMPULSOR	IMPELLER	GIRANTE	TURBINE	
	QSD 4.2 DIESEL	REC35-898272048		FILTRO AIRE	AIR FILTER	FILTRO ARIA	FILTRE D'AIR
REC35-879172104			FILTRO COMBUSTIBLE	DIESEL FILTER	FILTRO COMBUSTIBILE	FILTRE CARBURANT	
REC879150054			TERMOSTATO	THERMOSTAT	TERMOSTATO	THERMOSTAT	
REC57-898101579			CORREA	BELT	CINGHIE	COURROIE	
TEN01320T			ANODO	ANODE	ANODO	ANODE	
REC895207			FILTRO ACEITE	OIL FILTER	FILTRO OLIO	FILTRE À HUILE	
REC15W40U3			ACEITE MOTOR	OIL	OLIO MOTORE	HUILE MOTEUR	
JAB17937-0001-P		JABSCO	IMPULSOR	IMPELLER	GIRANTE	TURBINE	
SHE15000K		SHERWOOD	IMPULSOR	IMPELLER	GIRANTE	TURBINE	
3.0L V6 TDI DIESEL (TIER 3)		REC35-8M6002131		FILTRO AIRE	AIR FILTER	FILTRO ARIA	FILTRE D'AIR
	REC35-8M0067337		FILTRO COMBUSTIBLE	DIESEL FILTER	FILTRO COMBUSTIBILE	FILTRE CARBURANT	
	RECGS01030		FILTRO COMBUSTIBLE	DIESEL FILTER	FILTRO COMBUSTIBILE	FILTRE CARBURANT	
	REC8M0093480		TERMOSTATO	THERMOSTAT	TERMOSTATO	THERMOSTAT	
	REC57-8M0093495	Alt+ P.Steering	CORREA	BELT	CINGHIE	COURROIE	
	REC8M6002274		ANODO	ANODE	ANODO	ANODE	
	REC35-8M0066483		FILTRO ACEITE	OIL FILTER	FILTRO OLIO	FILTRE À HUILE	
	JAB17018-0001		IMPULSOR	IMPELLER	GIRANTE	TURBINE	

## KITS MANTENIMIENTO COLAS

## DRIVES MAINTENANCE KIT

## KIT MANUTENZIONE PIEDE

## KITS D'ENTRETIEN DES EMBASSES

		REF					
ALPHA ONE GEN I	RECKITALPHA1	REC60932A4	FUELLE TRANSON	U-JOINT BELOW	MANICOTTO TRANSON	SOUFFLET TRANSON	1
		REC54-815504320	ABRAZADERA INOX 32-50	HOSE CLAMP 32-50	FASCETTA INOX 32-50	COLLIER INOX 32-50	1
		REC47-89984Q5	KIT BOMBA AGUA	WATER PUMP KITS	KIT POMPA ACQUA	KIT POMPE À EAU	1
		RECKITMALPHA1AL	KIT ÁNODOS	ANODES KIT	KIT ANODI	KIT ANODES	1
		REC12-191833	JUNTA	GASKET	GUARNIZIONE	JOINT	2
		REC26-455771	RETÉN	SEAL	PARAOLIO	JOINT SPI	1
		REC18654A1	FUELLE ESCAPE	EXHAUST BELOW	MANICOTTO SCARICO	SOUFFLET ECHAPPEMENT	1
		REC27-94996Q2	KIT DE JUNTAS	GASKET KIT	KIT GUARNIZIONE	KIT JOINTS	1
ALPHA ONE GEN II	RECKITGENEII	REC816431A1	FUELLE TRANSON	U-JOINT BELOW	MANICOTTO TRANSON	SOUFFLET TRANSON	1
		REC54-815504320	ABRAZADERA INOX 32-50	HOSE CLAMP 32-50	FASCETTA INOX 32-50	COLLIER INOX 32-50	1
		REC12-191833	JUNTA	GASKET	GUARNIZIONE	JOINT	2
		REC26-455771	RETÉN	SEAL	PARAOLIO	JOINT SPI	1
		RECKITMALPHA2AL	KIT ÁNODOS	ANODES KIT	KIT ANODI	KIT ANODES	1
		REC47-43026Q06	KIT BOMBA AGUA	WATER PUMP KITS	KIT POMPA ACQUA	KIT POMPE À EAU	1
		REC53-815949	CIERRE METALICO	E-RING	CHIUSURA METALLICO	E-CLIP	2
		REC18654A1	FUELLE ESCAPE	EXHAUST BELOW	MANICOTTO SCARICO	SOUFFLET ECHAPPEMENT	1
REC27-94996Q2	KIT DE JUNTAS	GASKET KIT	KIT GUARNIZIONE	KIT JOINTS	1		
BRAVO	RECKITBRAVO	REC86840A05	FUELLE TRANSON	U-JOINT BELOW	MANICOTTO TRANSON	SOUFFLET TRANSON	1
		REC54-815504320	ABRAZADERA INOX 32-50	HOSE CLAMP 32-50	FASCETTA INOX 32-50	COLLIER INOX 32-50	1
		REC12-191833	JUNTA	GASKET	GUARNIZIONE	JOINT	2
		REC16755Q1	KIT DE JUNTAS	GASKET KIT	KIT GUARNIZIONE	KIT JOINTS	1
		RECKITBRAVO3AL	KIT ÁNODOS	ANODES KIT	KIT ANODI	KIT ANODES	1
		CM806188A	ÁNODO AL	ANODE AL	ANODO AL	ANODE AL	1
REC18654A1	FUELLE ESCAPE	EXHAUST BELOW	MANICOTTO SCARICO	SOUFFLET ECHAPPEMENT	1		

## GUÍA MANTENIMIENTO TRASMISIONES

## GUIDE MAINTENANCE TRANSMISSIONS

## GUIDA MANUTENZIONE TRASMISSIONI

## GUIDE MAINTENANCE TRANSMISSIONS

		REF					
TR/TRS (1977-93) (4794900+)		REC27-54014Q1	KIT JUNTAS TRANSON	TRANSON GASKET KIT	KIT GUARNIZIONE TRANSON	KIT JOINT TRANSON	1
		REC60932A4	FUELLE TRANSMISION	TRANSMISSION BELLOW	CUFFIA TRASMISSIONE	SOUFFLET CARDAN	1
		REC10-79953Q04	TAPON DE NIVEL ACEITE	OIL LEVEL CAP	TAPPO LIVELLO OLIO	BOUCHON DE NIVEAU D'HUILE	1
		REC10-79953Q04	TAPON DRENAJE ACEITE	OIL DRAIN CAP	TAPPO SCARICO OLIO	BOUCHON VIDANGE	1
		REC31640Q4AL	ANODO TIMON	RUDDER ANODE	ANODO TIMONE	ANODE DE TIMON	1
		REC80W90U6	ACEITE SINTETICO 80W-90	SYNTHETIC OIL 80W-90	OLIO SINTETICO 80W-90	HUILE SYNTHÉTIQUE 80W-90	2
R/ MR/ ALPHA ONE (1983-90) (6216687 - 0F386995)		REC27-94996Q2	KIT JUNTAS TRANSON	TRANSON GASKET KIT	KIT GUARNIZIONE TRANSON	KIT JOINT TRANSON	1
		REC30-879194A01	RODAMIENTO TRANSON	TRANSON BEARING	CUSCINETTO TRANSON	ROULEMENT TRANSON	1
		REC60932A4	FUELLE TRANSMISION	TRANSMISSION BELLOW	CUFFIA TRASMISSIONE	SOUFFLET CARDAN	1
		REC18654A1	FUELLE ESCAPE	EXHAUST BELLOW	CUFFIA DI SCARICO	SOUFFLET ECHAPPEMENT	1
		REC78458A1	FUELLE ESCAPE TUBO (454 MAG)	EXHAUST BELLOW TUBE (454 MAG)	CUFFIA DI SCARICO TUBO (454 MAG)	SOUFFLET ECHAPPEMENT TUBE (454 MAG)	1
		REC74639Q02	FUELLE CABLE CAMBIO	SHIFT WIRE BELLOW	CUFFIA CAVO CAMBIO	SOUFFLET CABLE CHANGEMENT	1
		REC10-79953Q04	TAPON DE NIVEL ACEITE	OIL LEVEL CAP	TAPPO LIVELLO OLIO	BOUCHON DE NIVEAU D'HUILE	1
		REC22-67892A05	TAPON DERENAJE ACEITE	OIL DRAIN CAP	TAPPO SCARICO OLIO	BOUCHON VIDANGE	1
		REC31640Q4AL	ANODO TIMON (2-3/8")	RUDDER ANODE (2-3/8")	ANODO TIMONE (2-3/8")	ANODE DE TIMON (2-3/8")	1
		REC55989Q9AL	ANODO TIMON (4")	RUDDER ANODE (4")	ANODO TIMONE (4")	ANODE DE TIMON (4")	1
		REC55989Q9AL	ANODO BOLA TRANSON	BALL ANODE TRANSON	ANODO BOLLA TRANSON	ANODE BALL TRANSON	1
		REC821631Q1AL	ANODO TRANSON (MERCAT)	TRANSON ANODE (MERCAT)	ANODO TRANSON (MERCAT)	ANODE TRANSON (MERCAT)	1
		CM43994	ANODO TRANSON (MERCAT) ANTIGUO	TRANSON ANODE (MERCAT) OLD	ANODO TRANSON (MERCAT) VECCHIO	ANODE TRANSON (MERCAT) ANCIEN	1
		RECKITMALPHA1AL	KIT ANODOS	ANODE KIT	KIT ANODI	KIT ANODES	1
		REC32-32461	TUBO AGUA 5/8" TRANSON	WATER TUBE 5/8" TRANSON	TUBO ACQUA 5/8" TRANSON	TUBE D'EAU 5/8" TRANSON	1
		REC32-4172533	TUBO AGUA 3/4" TRANSON	WATER TUBE 3/4" TRANSON	TUBO ACQUA 3/4" TRANSON	TUBE D'EAU 3/4" TRANSON	1
		REC47-89984T4	IMULSOR	IMPELLER	GIRANTE	TURBINE	1
		REC47-89984Q5	KIT BOMBA DE AGUA	WATER PUMP KIT	KIT POMPA ACQUA	KIT POMPE À EAU	1
		REC865436A03	KIT CABLE CAMBIO	SHIFT WIRE KIT	KIT CAVO CAMBIO	KIT CÂBLE CHANGEMENT	1
		REC805320A03	KIT SENSORES TRIM	SENSOR TRIM KIT	KIT SENSORI TRIM	KIT SONDAS TRIM	1
		REC80W90U6	ACEITE SINTETICO 80W-90	SYNTHETIC OIL 80W-90	OLIO SINTETICO 80W-90	HUILE SYNTHÉTIQUE 80W-90	2



	REF						
ALPHA ONE (GENII) (1991+) (OD469259+)	REC27-94996Q2	KIT JUNTAS TRANSOM	TRANSOM GASKET KIT	KIT GUARNIZIONE TRANSOM	KIT JOINTS TRANSOM	1	
	REC30-879194A01	RODAMIENTO TRANSOM	TRANSOM BEARING	CUSCINETTO TRANSOM	ROULEMENT TRANSOM	1	
	REC816431A1	FUELLE TRANSMISION	TRASMISION BELLOW	CUFFIA TRASMISSIONE	SOUFFLET TRANSMISSION	1	
	REC18654A1	FUELLE ESCAPE	EXHAUST BELLOW	CUFFIA DI SCARICO	SOUFFLET ECHAPPEMENT	1	
	REC74639Q02	FUELLE CABLE CAMBIO	SHIFT WIRE BELLOW	CUFFIA CAVO CAMBIO	SOUFFLET CÂBLE CHANGEMENT	1	
	REC10-79953Q04	TAPON DE NIVEL ACEITE	OIL LEVEL CAP	TAPPO LIVELLO OLIO	BOUCHON DE NIVEAU D'HUILE	1	
	REC22-67892A05	TAPON DERENAJE ACEITE	OIL DRAIN CAP	TAPPO SCARICO OLIO	BOUCHON VIDANGE	1	
	CM821629	ANODO PLACA	PLATE ANODE	ANODO PIASTRA	ANODE PLAQUE	1	
	REC821631Q1AL	ANODO TRANSOM (MERCAT)	TRANSOM ANODE (MERCAT)	ANODO TRANSOM (MERCAT)	ANODE TRANSOM (MERCAT)	1	
	REC76214Q5AL	ANODO TIMON (plano)	RUDDER ANODE (flat)	ANODO TIMONE (plano)	ANODE TIMON (plane)	1	
	CM46399	ANODO TIMON (aleta)	RUDDER ANODE (flap)	ANODO TIMONE (flap)	ANODE TIMON (flap)	1	
	REC806105Q1AL	ANODO HELICE (CARRIER)	PROPELLER ANODE (CARRIER)	ANODO ELICA (CARRIER)	ANODE HELICE (CARRIER)	1	
	REC806189Q1AL	ANODO BRAZO TRIM	TRIM ARM ANODE	ANODO BRACCIO TRIM	ANODE ARM TRIM	2	
	RECKITMALPHA2AL	KIT ANODOS	ANODE KIT	KIT ANODI	KIT ANODES	1	
	REC32-4172533	TUBO AGUA TRANSOM	WATER TUBE TRANSOM	TUBO ACQUA TRANSOM	TUBE À EAU TRANSOM	1	
	REC47-43026Q02	IMPULSOR	IMPELLER	GIRANTE	TURBINE	1	
	REC817275Q05	KIT BOMBA DE AGUA	WATER PUMP KIT	KIT POMPA ACQUA	KIT POMPE À EAU	1	
	REC865436A03	KIT CABLE CAMBIO	SHIFT WIRE KIT	KIT CAVO CAMBIO	KIT CÂBLE CHANGEMENT	1	
	REC805320A03	KIT SENSORES TRIM	SENSOR TRIM KIT	KIT SENSORI TRIM	KIT SONDE TRIM	1	
	REC80W90U6	ACEITE SINTETICO 80W-90	SYNTHETIC OIL 80W-90	OLIO SINTETICO 80W-90	HUILE SYNTHÉTIQUE 80W-90	2	
	BRAVO I / II & III	REC16755Q1	KIT JUNTAS TRANSOM	TRANSOM GASKET KIT	KIT GUARNIZIONE TRANSOM	KIT JOINTS TRANSOM	1
		REC30-879194A01	RODAMIENTO TRANSOM	TRANSOM BEARING	CUSCINETTO TRANSOM	ROULEMENT TRANSOM	1
		REC86840A05	FUELLE TRANSMISION	TRASMISION BELLOW	CUFFIA TRASMISSIONE	SOUFFLET TRANSMISSION	1
REC18654A1		FUELLE ESCAPE	EXHAUST BELLOW	CUFFIA DI SCARICO	SOUFFLET ECHAPPEMENT	1	
REC78458A1		FUELLE ESCAPE COLECTOR	EXHAUST BELLOW	CUFFIA SCARICO COLLETORE	SOUFFLET D'ECHAPPEMENT	1	
REC74639Q02		FUELLE CABLE CAMBIO	SHIFT WIRE BELLOW	CUFFIA CAVO CAMBIO	SOUFFLET CÂBLE CHANGEMENT	1	
REC22-67892A05		TAPON DE NIVEL ACEITE	OIL LEVEL CAP	TAPPO LIVELLO OLIO	BOUCHON DE NIVEAU D'HUILE	1	
REC22-67892A05		TAPON DERENAJE ACEITE	OIL DRAIN CAP	TAPPO SCARICO OLIO	BOUCHON VIDANGE	1	
CM821630		ANODO PLACA	PLATE ANODE	ANODO PIASTRA	ANODE PLAQUE	1	
CM43994		ANODO TRANSOM (MERCAT)	TRANSOM ANODE (MERCAT)	ANODO TRANSOM (MERCAT)	ANODE TRANSOM (MERCAT)	1	
CM76214Q5		ANODO TIMON (Plano con rosca)	RUDDER ANODE (flat with thread)	ANODO TIMONE (plano con filo)	ANODE TIMON (plane avec filet)	1	
CM762144		ANODO TIMON (plano sin rosca)	RUDDER ANODE (flat without thread)	ANODO TIMONE (plano senza filo)	ANODE TIMON (plane sans filet)	1	
CM806188		ANODO HELICE (CARRIER)	PROPELLER ANODE (CARRIER)	ANODO ELICA (CARRIER)	ANODE HELICE (CARRIER)	1	
CM865182CZ		ANODO EJE HELICE (BRAVO III 2004+)	SHAFT PROPELLER ANODE (BRAVO III 2004+)	ANODO ASSE ELICA (BRAVO III 2004+)	ANODO ARBRE D'HELICE (BRAVO III 2004+)	1	
CM806190		ANODO BRAZO TRIM	TRIM ARM ANODE	ANODO BRACCIO TRIM	ANODE ARM TRIM	2	
REC55989Q9		ANODO BOLA TRANSOM	BALL ANODE TRANSOM	ANODO BOLLA TRANSOM	ANODE BALL TRANSOM	1	
RECKITMBRAVO1AL		KIT ANODOS BRAVO I	ANODE KIT BRAVO I	KIT ANODI BRAVO I	KIT ANODES BRAVO I	1	
RECKITMBRAVO23AL		KIT ANODOS BRAVO II	ANODE KIT BRAVO II	KIT ANODI BRAVO II	KIT ANODES BRAVO II	1	
RECKITMBRAVO3AL		KIT ANODOS BRAVO III	ANODE KIT BRAVO III	KIT ANODI BRAVO III	KIT ANODES BRAVO III	1	
REC32-43437		TUBO AGUA TRANSOM (BRAVO I)	WATER TUBE TRANSOM (BRAVO I)	TUBO ACQUA TRANSOM (BRAVO I)	TUAYU À EAU TRANSOM (BRAVO I)	1	
REC815471T1		KIT CABLE CAMBIO	SHIFT WIRE KIT	KIT CAVO CAMBIO	KIT CÂBLE CHANGEMENT	1	
REC805320A03		KIT SENSORES TRIM	SENSOR TRIM KIT	KIT SENSORI TRIM	KIT SONDES TRIM	1	
REC80W90U6		ACEITE SINTETICO 80W-90	SYNTHETIC OIL 80W-90	OLIO SINTETICO 80W-90	HUILE SYNTHÉTIQUE 80W-90	3	

## MATERIALES GENÉRICOS PARA REVISION

## GENERIC MATERIALS FOR REVISION

## MATERIALE GENERICICO PER LA REVISIONE

## MATÉRIAUX GÉNÉRIQUES POUR L'EXAMEN

REF				
GS90002	PINTURA NEGRA MERCruiser EN SPRAY	BLACK PAINT MERCruiser SPRAY	PITTURA NERA MERCruiser. SPRAY	PEINTURE EN SPRAY NOIRE
GS90012	SPRAY IMPRIMACION PARA MOTORES	SPRAY PRIMER FOR ENGINES	PRIMER PER MOTORI. SPRAY	PRIMER POUR MOTEUR
GS90019	BARNIZ TRANSPARENTE PROTECTOR PINTURA EN SPRAY	CLEAR VARNISH, SPRAY PAINT PROTECTOR	VERNICE TRASPARENTE, PROTETTORE DI PITTURA. SPRAY	VERNIS TRANSPARENT, PROTECTEUR EN SPRAY
GS90090	PROTECTOR OXIDO MOTOR EN SPRAY	SPRAY ENGINE PROTECTOR FROM RUST	PROTETTORE MOTORE DALL'OSSIDAZIONE. SPRAY	PROTECTEUR MOTEUR DE L'OXYDATION EN SPRAY
GS90092	PROTECTOR DIELECTRICO EN SPRAY	SPRAY DIELECTRIC PROTECTOR	PROTETTORE DIELETTRICO. SPRAY	PROTECTEUR DIELECTRIQUE EN SPRAY
RECGREU1	BOTE GRASA MARINA 450 g	MARINE GREASE 450 g	GRASSO MARINO 450 g	GRAISSE MARINE 450g

# SISTEMA DE ALIMENTACIÓN Y FILTRACIÓN FUEL & FILTRATION SYSTEM

## SISTEMA DI ALIMENTAZIONE E FILTRAZIONE SYSTÈME D'ALIMENTATION ET DE FILTRATION



FILTRO DE COMBUSTIBLE Y ELEMENTOS

FUEL FILTERS AND ELEMENTS

FILTRI BENZINA E RACCORDI

FILTRE A ESSENCE ET CARTOUCHE DE RECHANGE

MOTORES GASOLINA

GAS ENGINE

MOTORI BENZINA

MOTEUR ESSENCE

BRACKET

BRACKET

SUPPORTO

TÊTE DE FILTRE À ESSENCE

Con 2 tapones de bronce y 2 tubos de extensión. (2 entradas y 2 salidas).

With 2 brass plugs and 2 extension tubes. (2 inputs & 2 outputs).

Con 2 tappi di bronzo e 2 tubi di estensione. (2 ingressi entrata carburante e 2 uscite carburante).

Avec 2 bouchons en bronze et 2 tubes d'extension. (2 entrées et 2 sorties).

REF		
REC25000	1/4"	AL
REC25010	1/4"	INOX /SS AISI316
REC25020	3/8"	AL
REC25030	3/8"	INOX /SS AISI316
RECOBBRACKET	1/4"	Plast.



REC25000 - REC25020



REC25010 - REC25030



RECOBBRACKET

RECMAR®

FILTRO COMBUSTIBLE SEPARADOR DE AGUA

WATER SEPARATING FUEL FILTER

FILTRO SEPARATORE ACQUA-BENZINA

FILTRE À ESSENCE

REF	MICRON	
REC24942	10	47/16" = 11 cm
REC35-802893Q01	10	3 3/4"
REC855686	28	4 7/16"
REC35-802893Q	25	3 3/4"
RACPF5510	10	4 7/16"

RACOR®

RECMAR®



RACPF5510



REC24942



REC35-802893Q01



REC855686



REC35-802893Q

REF	R.O./OEM		
RM35-866594Q01	35-866594Q01 35-866594K01	100VAZER, 100VAZER EC	3.0L MPI EC

RECMAR®



Filtro original.

OEM filter.

Filtro benzina originale.

Filtre à essence original

REF	MICRON	
RM35-802893Q	10	3 3/4"

QUICKSILVER



FILTRO CON BRACKET

Con 2 tapones de bronce y 1 tubo de extensión.

OEM FILTER WITH BRACKET

With 2 brass plugs & 1 extension tube.

FILTRO BENZINA CON SUPPORTO

Con 2 tappi di bronzo e 1 tubo di estensione.

FILTRE A ESSENCE AVEC SUPPORT

avec 2 bouchons en bronze et 1 tube d'extension

REF	MICRON			BRACKET
REC24950	25	1/4"		50 GPH AL
REC24952	10	1/4"		50 GPH AL

RECMAR®



**FILTRO DECANTADOR GASOLINA****COMPLETE FUEL FILTER****FILTRO DECANTATORE BENZINA****FILTRE DÉCANTEUR POUR ESSENCE****RACOR**

				RAC120R-RAC-01	RAC320R-RAC-01	RAC320R-INOX-01	RAC320R-RAC-02
FLUJO MÁXIMO	MAX. FLOW	FLUSSO MASSIMO	FLUX MASSIMALE	114 l/h 30 gph	340 l/h 60 gph	340 l/h 60 gph	340 l/h 60 gph
ELEMENTO	ELEMENT	ELEMENTO	ÉLÉMENT	RACS3240	RACS3213	RACS3213	RACS3220UL
CAZOLETA TRANSPARENTE (sólo se recomienda para fueraborda.)	CLEAR BOWL (just for outboards)	VASCHETTA TRASPARENTE (solo nei fuoribordo.)	CAZOLETA TRANSPARENTE (uniquement recommandé pour le hors-bord.)	✓ PLAST.	✓ PLAST.	✓ PLAST.	✗ METAL
ROSCAS CENTRALES	CENTRAL THREADS	FILETTO CENTRALE	FILS CENTRAUX	M18 x 1.5	1 1/4"	1 1/4"	1 1/4"
TAMAÑO ROSCA CABEZA	HEAD PORT SIZE	DIMENSIONE VITE TESTA	TAILLE DU FIL DE TÊTE	1/4-18 NPTF	1/4-18 NPTF	1/4-18 NPTF	1/4-18 NPTF
ALTURA X Ø	HEIGHT X Ø	ALTEZZA X Ø	HAUTEUR X Ø	166 x 81 mm	238 x 102 mm	238 x 102 mm	238 x 102 mm
PESO	WEIGHT	PESO	POIDS	0,5 kg	0,9 kg	0,9 kg	0,9 kg
CAIDA DE PRESIÓN	PRESSURE DROP	CADUTA DI PRESSIONE	CHUTE DE PRESSION	0.15 PSI 0.01 bar	0.61 PSI 0.04 bar	0.61 PSI 0.04 bar	0.61 PSI 0.04 bar
PRESIÓN MÁXIMA	MAX. PRESSURE	PRESIONE MASSIMA	PRESSION MAXIMALE	7 PSI 0.05 bar	7 PSI 0.05 bar	7 PSI 0.05 bar	7 PSI 0.05 bar
DESMONTAJE CARTUCHO-CAZOLETA	ELEMENT REMOVAL UNDERBOWL	RIMOZIONE DELLA CARTUCCIA	DÉMONTAGE DE LA CARTOUCHE	25,4 mm 1"	25,4 mm 1"	25,4 mm 1"	25,4 mm 1"
TEMPERATURA DE TRABAJO	OPERATING TEMPERATURE	TEMPERATURA DI LAVORO	TEMPERATURE DE TRAVAIL	-40°C +124°C			

**ELEMENTOS DE RECAMBIO****ELEMENT****ELEMENTI DI RICAMBIO****CARTOUCHE DE RECHANGE**

REF	OEM	
RACS3240		RAC120R-RAC-01
LENS3240		
RACS3227	35-886638	
LENS3227		
RACS3213		RAC320R-RAC-01
LENS3213	35-809097	RAC320R-RAC-01 INOX RAC320R-RAC-03
RACS3214	35-809099	
RACS3228UL		RAC320R-RAC-02, bracket RACOR

LENS3240  
LENS3227  
LENS3214RACS3240  
RACS3227  
RACS3214

RACS3228UL

RÁCORES DE LATÓN

BRASS RACORS

RACCORDI IN OTTONE

RACCORDS À LAITON



REF	OEM			
GS31066	22-89771Q2	1/4" NPT	5/16" = 7.9 mm	2
GS31067		1/4" NPT	3/8" = 9.5 mm	2
REC22-866725		3/4" NPT		

GOLDENSHIP

RECMAR®



GS31066  
GS31067



REC22-866725

REF			
GS31065	1/4" NPT	3/8" = 9.5 mm	1
GS31066	1/4" NPT	5/16" = 7.9 mm	2
GS31055	3/8" NPT	3/8" = 9.5 mm	2
GS31056	3/8" NPT	5/16" = 7.9 mm	2
GS31157	3/8" NPT	1/4" = 6.4 mm	2

GOLDENSHIP



FILTRO COMBUSTIBLE PARA MONTAJE EN LINEA

IN-LINE FUEL FILTER

FILTRO BENZINA PER MONTARE IN LINEA

FILTRE A ESSENCE EN LIGNE



REF				GOLDENSHIP
GS31001	50 l/h	6-8 mm	plast.	
GS31002	150 l/h	8-10 mm		



GS31001



GS31002

REF	OEM		
REC864572	864572 35-864572	3/8"	EFI & MPI, 8.1L & 496 CID (in-line) MPI & EFI (boost pump)

RECMAR®



REF	OEM	
REC1397-8767Q	GM 2.5L/3.0L (6229718+)	
	GM 5.0L/5.7L (6218462+)	
	205 (A331455+)	
	228 HP (6021784+)	
	330 HP (6083145+)	
	GM 255 (590768+)	
	5.7L SKI 340, 230 & 260 inboards	



REF	OEM		
REC35-8M0122423	35-884380T	4 7/16"	MCM 4.5L (V6) 6.2L (V8)
RAC31871	35-8M0020349		
	35-8M0060041		



REF	OEM		
REC35-866171A01	35-866171A01	4 7/16"	5.0 - 350 - 6.2 & 8.1 MPI, MIE 496 MAG con módulo de bomba combustible with fuel pump module con modulo pompa combustibile avec module pompa d'essence



REF	OEM		
REC35-8M0046752	35-8M0046752 35-11004A1 35-803897Q1	4 7/16"	2.5L/3.0L (6229718+) MCM224 CID (6218037+) GM262 CID (A331455+) con carter de bomba combustible with carter fuel pump con carter pompa combustibile avec carter pompe d'essence





**FILTRO DE GASOLINA  
CARBURADOR****CARBURETOR FUEL FILTER****FILTRO BENZINA  
CARBURATORE****FILTRE À ESSENCE  
CARBURATEUR**

REF	OEM	
REC35-53336	35-53336Q 35-53336 3302-9033	GM INLINE 4 & 6 cyl FORD & GM V8 400 HP+ MERCUISER 224 CID



REF	OEM	CARB.
REC93568	35-93568	ROCHESTER 2BBL & 4 BBL
REC35-49088A2	35-49088Q2 35-49088A2	4 & 6 CYL INLINE
REC1397-2150	1397-2150	ROCHESTER



REC93568



REC35-49088A2



REC1397-2150

**FILTRO VST****VST FILTER****FILTRO VST****FILTRE VST**

REF	OEM	
REC65L-13915-00	808504 8085041 808504T1	262 MAG (TBI) GEN+
		350 MPI, TBI, EFI (1994-96)
		454 EFI (GEN V) GM (1994-96)
		454 EFI (SKI GEN V) GM (1995)
		454 MAG BRAVO MPI (GEN VI) GM (1996-97)
		5.7 EFI (TBI) GM 350 V8 (1995)
		7.4L MIE MPI (LH) (GEN V) GM (1995-96)
		7.4L MIE MPI (LH) (GEN VI) GM (1996-97)
		7.4LX BRAVO MPI (GEN V) GM (1996)
		7.4LX BRAVO MPI (GEN VI) GM (1996-97)
8.2L MIE MPI (LH) (GEN VI) GM (1996-97)		



REF	OEM	
REC35-892665	35-892665	5.0 (350, 377, 383, 496) 6.2 & 8.1 MPI

**FILTROS AIRE****AIR FILTER****FILTRI ARIA****FILTRE AIR**

REF	OEM	
RM35-863829	35-863829	350 MAG
		383 MAG
		496 MAG
		357 HRZ
		4.3L MPI
		5.0L MPI
		6.2L MPI



REF	OEM	
RM35-8M2001030	35-8M2001030	350 MAG MPI
		377 MAG MPI
		4.3L MPI
		5.0L MPI
		5.7L MPI
		6.2L MPI



**FILTRO DE ACEITE**
**OIL FILTER**
**FILTRO OLIO**
**FILTRE A HUILE**

REF	OEM		
RM35-883702Q	35-883702Q	18 mm x 1.5	V6 GM MCM V-6 *
RM35-866340Q02	35-866340Q03	13/16" x 16 NPT	GM 4 inline, V8 MCM / MIE GM V-6 *

\* sin filtro de aceite remoto  
 \* without oil remote filter  
 \* senza filtro dell'olio remoto  
 \* sans filtre à huile à distance

REF	OEM		
REC35-06004	35-883702Q	18 mm x 1.5	GM V6
REC35-06003	35-866340Q03	13/16" x 16 NPT	GM 4 inline, V8
REC35-06007	35-802886Q 60565 35-8M0116378	3/4" x 16 NPT	V8 Ford

REF	OEM		
REC3850559	35-16595Q	2006+ MCM HiPerformance GM V8	

**new**

**FILTRO ACEITE PARA DIRECCION HIDRAULICA AXIUS**
**HYDRAULIC OIL FILTER FOR AXIUS POWER STEERING**
**FILTRO OLIO PER MOTORI CON STERZO IDRAULICO AXIUS**
**FILTRO D'HUILE POUR MOTEURS AVEC DIRECTION HYDRAULIQUE AXIUS**

REF	OEM		
REC35-8M0138697	35-8M0138697 35-881132T	MCM AXIUS STEERING	

**new**





## GUÍA ACEITE

## OIL GUIDE

## GUIDA OLIO

## GUIDE D'HUILE

MOD.	BASE	 (l)	REF.
MCM 60	1965-68 Renault - L4	2,6	REC25W40U3
MCM 80	1966-69 Renault - L4	4,73	REC25W40U3
MCM 90	1970-72 Renault - L4	4,73	REC25W40U3
MCM 110/120/2.5L	1963-89 GM - L4	3,78	REC25W40U3
MCM140/3.0L/LX	1968+ GM - L4	3,78	REC25W40U3
MCM 470/165/170/3.7L	1976-89 Mercury - L4	5,2	REC25W40U3
MCM 485	1980-82 Mercury - L4	5,44	REC25W40U3
MCM 488/180/190/3.7LX	1983-89 Mercury - L4	6,15	REC25W40U3
MCM 140	1963 GM - L6	4,73	REC25W40U3
MCM 160/165	1967-81 GM - L6	4,73	REC25W40U3
MCM 200	1969 GM - L6	5,68	REC25W40U3
MCM 185 (4bbl)	1983-84 GM - V6	4,26	REC25W40U3
MCM 175/185/205	1985-87 GM - V6	4,26	REC25W40U3
MCM262 Mag EFI	1996-97 GM - V6	4,26	REC25W40U3
MCM 4.3L/LX/LH/LIIX & 262 Mag	1988-01 GM - V6	4,26	REC25W40U3
MCM 4.3L EFI	1998-01 GM - V6	4,26	REC25W40U3
MCM 4.3L & MPI	2002+ GM - V6	3,78	REC25W40U3
MCM 888	1971-77 Ford - V8	5,68	REC25W40U3
MCM/M1E 225	1973-74 Ford - V8	5,68	REC25W40U3
MCM/MTE 215	1970-72 Ford - V8	6,62	REC25W40U3
MCM 190	1963-64 GM - V8	4,73	REC25W40U3
MCM 898/200/5.0L	1977-95 GM - V8	4,73	REC25W40U3
MCM 228	1977-78 GM - V8	4,73	REC25W40U3
MCM 228/ 230/5.0LX	1979-95 GM - V8	5,2	REC25W40U3
MIE 198/228/230/5.0L	1977-88 GM - V8	5,68	REC25W40U3
MCM 5.0L & EFI	1998-02 GM - V8	5,2	REC25W40U3
MCM 5.0L & MPI	2002-up GM - V8	4,26	REC25W40U3
MCM 225	1963-66 GM - V8	4,73	REC25W40U3
MCM 225/250	1967-69 GM - V8	6,62	REC25W40U3
MIE 225/250	1968 GM - V8	5,68	REC25W40U3
MCM 250/255	1975-77 GM - V8	4,73	REC25W40U3
MCM 260/5.7L/LX & EFI	1978-02 GM - V8	5,2	REC25W40U3
MCM 350 MAG, EFI, & MPI	1986-02 GM - V8	5,2	REC25W40U3
MCM 350 MAG & MPI	2002+ GM - V8	4,26	REC25W40U3
MCM 5.7L	2002+ GM - V8	4,26	REC25W40U3
MIE 255/260/5.7L	1975-93 GM - V8	5,68	REC25W40U3
MIE 5.7L & EFI	1993-97 GM - V8	3,78	REC25W40U3
MIE 5.7L/ 350 Mag MPI	1998-02 GM - V8	5,2	REC25W40U3

MOD.	BASE	 (l)	REF.
MIE 5.7L/ 350 Mag MPI	2002+ GM - V-8	4,26	REC25W40U3
MIE Ski 5.7L	1985-89 GM - V-8	3,78	REC25W40U3
MIE Ski 5.7L/350 Mag & MPI	1990-97 GM - V-8	4,73	REC25W40U3
MIE Ski 5.7L/350 Mag & MPI	1998-02 GM - V-8	5,2	REC25W40U3
MIE Ski 5.7L/350 Mag & MPI	2002+ GM - V-8	4,26	REC25W40U3
Black Scorpion Ski (Gen+)	1996-97 GM - V-8	4,73	REC25W40U3
Black Scorpion Ski (Gen+)	1998-01 GM - V-8	5,2	REC25W40U3
Black Scorpion Ski (Gen+)	2003+ GM - V-8	4,26	REC25W40U3
MX 6.2L MPI	2000-02 GM/Mercury - V-8	5,2	REC25W40U3
MX 6.2L MPI	2002+ GM/Mercury - V-8	4,26	REC25W40U3
MX 6.2L MPI MIE	1999-02 GM/Mercury - V-8	5,2	REC25W40U3
MX 6.2L MPI MIE & Ski	2002+ GM/Mercury - V-8	4,26	REC25W40U3
MX 6.2L Bik Scorpion Ski	2001-03 GM/Mercury - V-8	5,2	REC25W40U3
MX 6.2L Bik Scorpion Ski	2003+ GM/Mercury - V-8	4,26	REC25W40U3
MCM 233/255	1973-77 Ford - V-8	4,73	REC25W40U3
MIE 233/255 - V-Drive	1973-76 Ford - V-8	6,62	REC25W40U3
MCM 325	1969-72 GM - V8	7,57	REC25W40U3
MIE 325	1968-74 GM - V8	6,62	REC25W40U3
MCM 330	1977-81 GM - V8	5,68	REC25W40U3
MCM 330 & 454 Mag Alpha	1982-88 GM - V8	6,62	REC25W40U3
MCM 7.4L & 454 Mag	1988-91 GM - V8	7,57	REC25W40U3
MCM 7.4L/LX & 454 Mag, EFI & MPI	1992-01 GM - V8	6,62	REC25W40U3
MIE 330	1977-80 GM - V8	6,62	REC25W40U3
MIE 340/7.4 w/Borg Warner trans.	1981-92 GM - V8	6,62	REC25W40U3
MIE 7.4L w/Hurth trans.	1988-92 GM - V8	7,57	REC25W40U3
MIE 7.4L & 454 Mag MPI	1992-01 GM - V8	6,62	REC25W40U3
MIE Ski 454 Mag EFI & MPI	1995-97 GM - V8	6,62	REC25W40U3
MCM 390	1969-70 GM - V8	7,57	REC25W40U3
MIE 390	1969-70 GM - V8	6,62	REC25W40U3
MCM 496 Mag & HO	2001+ GM - V8	8,51	REC25W40U3
MIE 8.1 S Horizon & HO	2001+ GM - V8	8,51	REC25W40U3
MCM 502 Mag	1990-92 GM - V8	7,57	REC25W40U3
MCM 502 Mag, EFI & MPI	1992-01 GM - V8	6,62	REC25W40U3
MIE 8.2L	1990-96 GM - V8	7,57	REC25W40U3
MIE 8.2L	1996-06 GM - V8	6,62	REC25W40U3

FILTRO DE COMBUSTIBLE Y ELEMENTOS

FUEL FILTERS AND ELEMENTS

FILTRI BENZINA E RACCORDI

FILTRE A ESSENCE ET CARTOUCHE DE RECHANGE

MOTORES DIESEL

DIESEL ENGINE

MOTORI DIESEL

MOTEUR DIESEL



REF	OEM	
REC882376	882376	1.7DTI Original MS120

REF	OEM	
REC35-808275	35-808275	D7.3/270 Bravo Et MIE Diesel (1994-96)

REF	OEM	
REC35-19486	35-19486 35-8M0103963	D254 D3.0L D3.6L D4.2L

REF	OEM	
REC35-807256	35-807256T	D3.0L D3.6L D7.3L D-Tronic CMD 2.8 CMD 4.2 D2.8L

REF	OEM	
REC35-8M0067337	35-8M0067337	MCM/MIE 1.9L, 2.5L, 3.0L V6 AMD V8 TDI

**new**

REF	OEM	
REC35-879172104	35-879172104	(MQSD MODELS) 2.0L, 2.8L, 4.2L base VM

REF	OEM	MICRON	
REC35-8M6002390	35-8M6002390	2	MCM/MIE 4.2L V8 TDI 335 Et 370 (CMC000200+)

**new**





FILTRO CON CAZOLETA

BOWL FILTERS

FILTRO CON COPPA

FILTRE AVEC COUPE

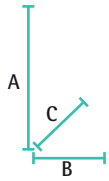

**RACOR**



	RAC500MA30	RAC900VMA	RAC900MA30	RAC1000VMA	RAC1000MA30	RAC75/500MAX	RAC75/1000MA30
	227 l/h 60 gph	340 l/h 90 gph	341 l/h 90 gph	681 l/h 180 gph	681 l/h 180 gph	454 l/h 120 gph	681 / 1363 l/h 180 / 360 gph
	2010	2010	2040	2010	2020	2010	2020
A X B X C	292 x 147 x 122 mm	432 x 220 x 200 mm	432 x 152 x 178 mm	557 x 220 x 200 mm	559 x 152 x 178 mm	292 x 368 x 241 mm	559 x 476 x 279 mm
	3/4"-16 UNF	7/8"-14 UNF	7/8"-14 UNF	7/8"-14 UNF	7/8"-14 UNF	3/4"-16 UNF	7/8"-14 UNF
	2 kg	4,9 kg	3 kg	5,6 kg	5 kg	7,7 kg	13,6 kg
CAIDA DE PRESIÓN PRESSURE DROP CADUTA DI PRESSIONE CHUTE DE PRESSION	0.61 PSI 0.04 bar	0.30 PSI 0.021 bar	0.34 PSI 0.02 bar	0.43 PSI 0.03 bar	0.49 PSI 0.03 bar	0.70 PSI 0.05 bar	3.70 PSI 0.25 bar
MAX	15 PSI 1 bar	15 PSI 1 bar	15 PSI 1 bar	15 PSI 1 bar	15 PSI 1 bar	15 PSI 1 bar	15 PSI 1 bar
MÀX.	102 mm	127 mm	127 mm	254 mm	254 mm	102 mm	254 mm

ELEMENTOS DE RECAMBIO

ELEMENTS

ELEMENTI DI RICAMBIO

CARTOUCHE DE RECHANGE

500	900	1000	MICRON
RAC2010SM-OR	RAC2040SM-OR	RAC2020SM-OR	2
RAC2010TM-OR	RAC2040TM-OR	RAC2020TM-OR	10
RAC2010PM-OR	RAC2040PM-OR	RAC2020PM-OR	30

**RACOR**



S: SECUNDARIO  
T: PRIMARIO O SECUNDARIO/FINAL  
P: PRIMARIO

S: SECONDARY FINAL  
T: PRIMARY OR SECONDARY FINAL  
P: PRIMARY

S: SECONDARIO  
T: PRIMARIO O SECONDARIO  
P: PRIMARIO

S: SECONDAIRE  
T: PRIMAIRE OU SECONDAIRE  
P: PRIMAIRE

REF	OEM		MICRON
REC3581760	3581760	R500MA	30
REC889419	889419	R900MA	
REC889422	889422	R1000MA	

**RECMAR**



REC3581760

REC889419

REC889422

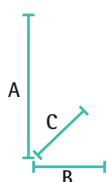

**RACOR.**



				RAC120AS	RAC230R2	RAC245R2	RAC460R2	RAC490R2
FLUJO MÁXIMO	MAX. FLOW	FLUSSO MASSIMO	FLUX MAXIMUM	57 l/h 15 gph	114 l/h 30 gph	170 l/h 45 gph	227 l/h 60 gph	341 l/h 90 gph
ELEMENTO	ELEMENT	ELEMENTO	ÉLÉMENT	RACR12	RACR20	RACR25	RACR60	RACR90
DIESEL				✓	✓	✓	✓	✓
GAS				✓				
CAZOLETA TRANSPARENTE	CLEAR BOWL	VASCHETTA TRASPARENTE	BOL TRASPARENT	✓	✓	✓	✓	✓
INSTALACIÓN VACUÓMETRO	VACUUM INSTALLATION	INSTALLAZIONE VACUOMETRO	INSTALLATION VACUOMETRE	✓	✓	✓	✓	✓
INSTALACIÓN PRESIÓN	PRESSURE INSTALLATION	INSTALLAZIONE PRESSIONE	INSTALLATION PRESSION	✓	✓	✓	✓	✓
A X B X C (mm)				165 x 81 x 81	229 x 102 x 102	267 x 102 x 102	279 x 114 x 121	300 x 114 x 121
PESO	WEIGHT	PESO	POIDS	0,59 kg	0,90 kg	1 kg	1,3 kg	1,4 kg
CAIDA DE PRESIÓN	PRESSURE DROP	CADUTA DI PRESSIONE	CHUTE DE PRESSION	0.15 PSI 0.01 bar	0.31 PSI 0.02 bar	0.61 PSI 0.04 bar	0.39 PSI 0.03 bar	0.95 PSI 0.06 bar
PRESIÓN MÁXIMA	MAX. PRESSURE	PRESSIONE MASSIMA	PRESSION MAXIMALE	7 PSI	30 PSI	30 PSI	30 PSI	30 PSI
ENTRADA	IN	ENTRATA	ENTRÉE	1/4" NPT	1/4" NPT	1/4" NPT	3/8" NPT	3/8" NPT
BOMBA CEBADO (SÓLO PARA DIESEL)	PRIMER PUMP (ONLY DIESEL)	POMPA (SOLO PER DIESEL)	POMPE (SEULEMENT POUR DIESEL)	✗	✓	✓	✓	✓
Nº TOMAS	NUM. OF PORTS	Nº FORI	Nº D'ENTREE / SORTIE	4	3	3	4	4
TIPO DRENAJE	DRAIN TYPE	TIPO DRENAGGIO	TYPE DE DRAINAGE	Sello positivo   Positive seal   Tenuta positiva   Joint positif				
OPCIÓN SENSOR AGUA	WATER SENSOR OPTION	OPZIONE SENSORE ACQUA	OPTION SONDE DE PRESENCE D'EAU	✓	✓	✓	✓	✓

REF	MICROM
RACR11T	10



REF	MICROM
RACR24S	2
RACR24T	10
RACR24P	30



REF	MICROM
RACR60S	2
RACR60T	10
RACR60P	30



REF	MICROM
RACR12S	2
RACR12T	10
RACR12P	30



REF	MICROM
RACR25S	2
RACR25T	10
RACR25P	30



REF	MICROM
RACR90S	2
RACR90T	10
RACR90P	30



REF	MICROM
RACR20S	2
RACR20T	10
RACR20P	30



REF	MICROM
RACR26S	2
RACR26T	10
RACR26P	30



REF	MICROM
RACR120SM	2
RACR120TM	10
RACR120P	30





REF		
REC1140639	REC3581078	50 l/h



**RECmar®**



REF		
REC120	RACR12	15 l/h



**RECmar®**





**new**

REF		MICROM		
REC1766160	REC160ELEMENT	10	205-420 L/H (2.45PSI)	11/16" 10 mm

**new**

REF	OEM			
REC500MA	35-850481 35-850481A1	REC3581760	13 mm 10 mm	227 l/h

**new**





REF			
REC296TWIN	REC3581078	50 L/H	GS30432 (8mm) GS30433 (10 mm)

**new**



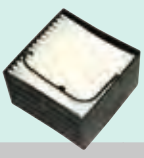

REF				CUBETA BOWL VASCHETTA SEAU METAL.
REC2656613	REC3581078	50 l/h	GS30432 (8mm) GS30433 (10 mm)	

**new**

REF			
RECSWK-2000/10	RECGS01030	600 L/H	M22X1.5

**new**

REF			
RECSWK-2000/5	RECGS00530	300 L/H	M16 X 1.5

FILTROS TIPO SEPAR 2000 FILTER TYPE SEPAR 2000 FILTRI DI TIPO SEPAR 2000 CARTOUCHE DE RECHANGE



REF	OEM	MICROM				
			(l/h)	(mm)	(mm)	(mm)
RECGS00530		10	300	75	24	75
RECGS01030	35-8M0067597	30	600	88	55	88
RECGS01830		30	1080	136	55	138

RECMAR®

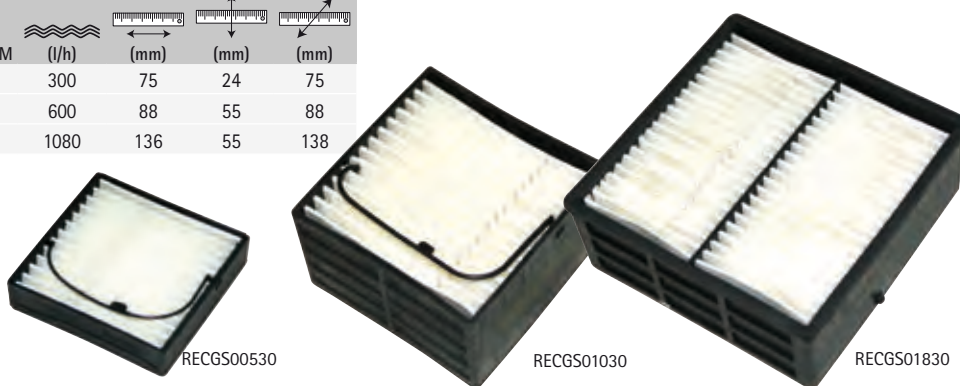

FILTROS AIRE

AIR FILTER

FILTRI ARIA

FILTRE AIR



REF	OEM	
REC35-8M6002131	35-8M6002131	3.0L TDI 100/230/260 V6

new

REF	OEM	
REC35-879172143	35-879172143	CMD QSD 2.0 115/130/150/170

new

REF	OEM	
REC35-898272048	35-898272048	CMD QSD 4.2 270/320/350

new

REF	OEM	
REC879172	879172 896332162	CUMMINS CMD 2.8 ES, EFI

new

REF	OEM	
REC35-19487	35-19487	530D 636D D183 D219 D254 D7.3L

REF	OEM	
REC35-805312	35-805312	D2.8L D254 D4.2L CMD MODELS





### FILTRO TRANSMISION HURTH

### FILTRO TRANSMISION HURTH

### FILTRO TRASMISSIONE HURTH

### FILTRE TRANSMISSION HURT

REF	OEM	
REC016940	879194241 35-815419	Mercruiser V8 Hurth Transmission 8.1L & 8.2L Inboard ZEUS 3000

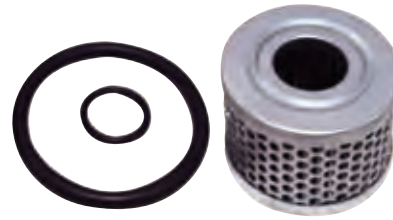

### FILTRO DE ACEITE

### OIL FILTER



### FILTRO OLIO

### FILTRE A HUILE

new

REF	OEM		Ø
REC35-879312041	35-879312041	(2008+) QSD 2.0 MCM ES 30 (88206399+) MCM ES 150 (88221799+) MCM ES 170 (88231000+) MIE EI 115 (88200499+) MIE EI 130 (88205099+) MIE EI 150 (88220299+) ME EI 170 (88230000+)	67 mm



REF	OEM		
REC3517857	35-803470 35-80470Q	3/4" x 16 NPT	60 & 80 HP (RENAULT)

Filtro corto  
Short filter  
Filtro corto  
Filtre court





REF	OEM	
REC127695-35150	35-19485	530D, 636D D2.8L, D3.0L, D3.6L, D4.2L Motores VM engines

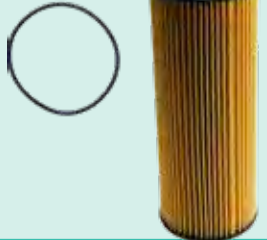

new

REF	OEM	
REC35-8M0066483	35-8M0066483	3.0L V6 4.2L V8 TDI



REF	OEM		
REC3850559	35-16595T1 35-16595Q 35-52731	13/16" x 16 NPT	230 CID, 250 CID 198 GM, 228 GM, 150 GM 330, 350, 370, 400, 420, 440, 460, 898

Filtro largo  
Long filter  
Filtro lungo  
Filtre large



REF	OEM	
REC35-805809	35-805809 35-805809T	D7.3L



REF	OEM	
REC35-816168	35-816168	D254, D3.0L, D3.6L, D4.2L

REF	OEM	
REC882687	882687 35-8M0150917	1.7DTS 120 diesel

REF	OEM	Ø	
REC895207	895207	3.25" (83 mm)	CUMMINS 2,8L CMD, QSD 2.0 / 2.8 / 4.2

GUÍA ACEITE		OIL GUIDE		GUIDA OLIO		GUIDE D'HUILE	
MOD.		(l)	REF.	MOD.		(l)	REF.
D1.7L DTI (Alpha)	2001+	1.7L	4,49 REC15W40U3	D254 Turbo AC (Bravo Et MIE)	1990-93	4.2L	12,06 REC15W40U3
D2.8L D-Tronic (Bravo Et MIE)	1997+	2.8L	8,04 REC15W40U3	D4.2L (Bravo Et MIE)	1994-97	4.2L	12,06 REC15W40U3
D183 Turbo AC (Bravo Et MIE)	1990-93	3.0L	8,99 REC15W40U3	D4.2L D-Tronic (Bravo Et MIE)	1997+	4.2L	12,06 REC15W40U3
530 D-TA (Bravo Et MIE)	1989-93	3.0L	8,99 REC15W40U3	D4.2L LD	1999+	4.2L	12,06 REC15W40U3
D3.0L (Bravo Et MIE)	1994-97	3.0L	8,99 REC15W40U3	7.3L (Bravo Et MIE)	1994-96	7.3L	11,35 REC15W40U3
D219 Turbo AC (Bravo Et MIE)	1990-93	3.6L	9,93 REC15W40U3	D7.3L D-Tronic	1996-01	7.3L	15,61 REC15W40U3
636 D-TA (Bravo Et MIE)	1989-93	3.6L	9,93 REC15W40U3				
D3.6L (Bravo Et MIE)	1994-97	3.6L	9,93 REC15W40U3				
D3.6L W (Bravo (MCM)(Intl.))	1997	3.6L	9,93 REC15W40U3				







RACORS		RACORS		RACCORDI		RACCORDS		
REF				ORIENTABLES	GUIDEBLE	ORIENTABILE	ORIENTABLE	
GS30430	8 mm	2		REF				
GS30431	10 mm	2		GS30432	8 mm	2		GS30433

**GOLDENSHIP**





REF		
REC500MACON	500	3/8" = 10 mm

**new**

REF				
RAC1/2X16	1/2"	16 mm		1
RAC1/2X18	1/2"	18 mm		1
RAC1/2X20	1/2"	20 mm	500 900	1
RAC3/8X10	3/8"	10 mm	1000	1
RAC3/8X12	3/8"	12 mm		1
RAC3/8X14	3/8"	14 mm		1

**RACOR**



REF	NPT	NPT		
RAC1/2F-1/2M	7/8"	1/2"	900 1000	1
RAC3/8F-3/8M	3/4"	3/8"	500	1



REF	NPT		
BRA125-3/16x1/4	1/4"	3/16"	1
BRA125-1/4x1/2	1/2"	1/4"	1
BRA125-5/16x3/8	3/8"	5/16"	1
BRA125-3/8x3/8	3/8"	3/8"	1
BRA125-3/8x1/2	1/2"	3/8"	1
BRA125-1/2x3/8	3/8"	1/2"	1
BRA125-1/2x1/2	1/2"	1/2"	1
BRA125-1/2x3/4	3/4"	1/2"	1
BRA125-5/8x3/8	3/8"	5/8"	1
BRA125-5/8x3/4	3/4"	5/8"	1
BRA125-3/4x3/4	3/4"	3/4"	1
BRA125-1x3/4	3/4"	1"	1



**ACCESORIOS PARA FILTROS**

**FILTER ACCESSORIES**

**ACCESSORI PER FILTRI**

**ACCESSOIRES POUR FILTRES**

**LLAVES PARA FILTRO**

**FILTER KEY**

**CHIAVE DA FILTRO**

**CLÉ À FILTRE**

REF
RACRK22628

**RACOR**



REF	
RECR0720	65 - 110 mm

**RECMAR**

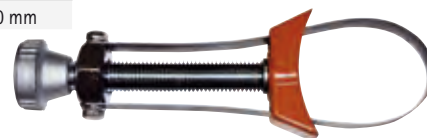

**VÁLVULA DRENAJE AGUA DE FILTROS RACOR**

**DRAIN VALVE FOR RACOR FILTERS**

**VALVOLA DRENAGGIO ACQUA PER FILTRI RACOR**

**VANNE DE DRAINAGE D'EAU POUR FILTRE RACOR**

REF
RACRK19492UL

**RACOR**



**SENSOR DE AGUA PARA FILTROS DIESEL**

**WATER SENSOR FOR DIESEL FILTERS**

**SENSORE ACQUA PER FILTRI DIESEL**

**SONDE DE PRESENCE D'EAU POUR DIESEL**

REF
RECRK21069

**RECMAR**



**RELOJ SENSOR DE AGUA**

**WATER ALARM**

**ALLARME SENSORE ACQUA**

**ALARME SENSOR D'EAU**

REF
RACRK20726

**RACOR**



# BOMBA DE COMBUSTIBLE

# FUEL PUMP

# POMPA COMBUSTIBILE

# POMPE À CARBURANT

## BOMBA DE COMBUSTIBLE MECÁNICA

## FUEL PUMP MECHANICAL

## POMPA COMBUSTIBILE MECCANICA

## POMPE À CARBURANT MECANIQUE

REF	OEM	Icon	Icon	Icon
REC862077A1	41141A2 862077A1	V6	REC35-8M0046752	REC27-34213

REF	OEM	Icon
REC86246T	86246T 86246 86246A1 78485 71646	V8

REF	OEM	Icon
REC86247T	62092T 62092 54552	Ford V8 302



REF	OEM	Icon
REC86247T	86247T 86247 86247A2 78820 63196 46860	V8 454 330, 325, 350, 390

REF	OEM	Icon
REC862048A1	812454A1 812454A3 97399A2 862048A1 97399	V8 305, 350, 454, 330, 420 Inline (4 cyl) 120, 140, 3.0L & 224 CID

REF	OEM	Icon	Icon
REC86234A4	86234A4 8623405 86234A3 86234 77594 71327 47585	GM (4 & 6 cyl) 153, 181, 225, 250, 120, 140, 160, 165, 470, 185, 488	REC35-49088A2

REF	OEM	Icon
REC861677T	861677T 818383T	GM V8 (454 & 502)



REF	OEM		
REC8M0073435	8M0073435 861676T09 861676A1 842725A3	GM 4 cyl (2.5 / 3.0L) MCM 3.7L 3.0L (SNL097000+)	REC35-8M0046752



REF	OEM	
REC8M0058164	8M0058164 97401	GM V8 305, 350, 228 / 230 / 260 / 898



**JUNTAS**                      **GASKETS**                      **GUARNIZIONI**                      **JOINTS**

REF	OEM
REC27-34213	27-34213
REC27-42457	27-42457
REC27-72805	27-72805
REC27-34898	27-34898



**GUÍA BOMBAS MECANICAS**                      **MECHANICAL PUMP GUIDE**                      **GUIDA POMPI MECCANICHE**                      **GUIDE DE POMPES MECANQUES**

MOD.	SERIAL	REF	MOD.	SERIAL	REF
120	1666601 - 3377340	REC86234A4	205/4.3L-LX (262 CID)	B527955+	REC862077A1
120	-4469866	REC86234A4	215 FORD	-3085036	REC62092T
120	4469866 - 4952700	REC86234A4	215 FORD	3258182	REC62092T
120	4952701	REC86234A4	225 FORD	3385721	REC62092T
120	5192049 - 6229717	REC86234A4	228 GM	4765100 - 5170008	REC86246T
120/2.5L	6229718	REC86234A4	228 GM	5170009 - 6218461	REC86246T
120/2.5L	6229718	REC8M0073435	228 GM	6218462	REC8M0058164
140 (4 CYL.)	2508261 - 3332137	REC86234A4	230 GM INBOARD	5907058	REC8M0058164
140	-4460664	REC86234A4	230/5.6L-GM (IB)	B522506+	REC8M0058164
140	4460665-4918569	REC86234A4	230 GM	6218462	REC8M0058164
140	4918570	REC86234A4	230/5.0L-LX GM	B525982+	REC8M0058164
140 (4 CYL.)	5157669 - 6229717	REC86234A4	233 FORD	4500860	REC62092T
140/3.0L	6229718	REC86234A4	255 GM	4768000 - 4908849	REC86246T
140/3.0L	6229718	REC8M0073435	255 GM	3258728	REC62092T
3.0L/3.0LX	C856559+	REC8M0073435	260 GM	4175500 - 5195908	REC86246T
160	2048022 - 2770031	REC86234A4	260 GM	5195909	REC86246T
165	4471566 - 4884834	REC86234A4	260/5.7 GM	4908850 - 6218461	REC86246T
165	5178959	REC86234A4	260 GM INTRABORDA	6218461	REC8M0058164
165/3.7-LX (4 CIL.)	6916779	REC8M0073435	260/5.7L GM (IB)	B525982+	REC8M0058164
170 (4 CIL.)	6916779	REC8M0073435	5.7L-GM	5907058	REC8M0058164
180/3.7-LX (4 CIL.)	6916779	REC8M0073435	280 GM	5907058	REC8M0058164
175/4.3L (262 CID)	B527955+	REC862077A1	300MR/TRS GM	F025000+	REC8M0058164
185 (229 CID)	6330183	REC862077A1	325-GM	4176250	REC86246T
185 (262 CID)	A331455+	REC862077A1	330 GM	6668677	REC8M0058164
190 (4 CIL.)	6916779	REC8M0073435	330 GM/W.B.W.	2278747 - 3640670	REC86247T
200	2453769 - 2712072	REC86234A4	340/7.4L-GM (IB)	4623115	REC86247T
200 GM	6218462	REC8M0058164	350 GM	6083145	REC862048A1
200/5.0L GM	B525982+	REC8M0058164	350-GM (MAGNUM)	5889914	REC862048A1
205 (262 CID)	A331455+	REC862077A1	350 (MAG-TOURNEY SKI)	3780450	REC86247T

MOD.	SERIAL	REF
370 TRS-GM	A635178+	REC8M0058164
390-GM	D505450+	REC8M0058164
420-GM	6721528	REC862048A1
425-GM	2781129 - 2825059	REC86247T
454 GM (MAGNUM)	A398941+	REC862048A1
454 MAG. BRAVO GM	A398941+	REC862048A1
470	A631894 +	REC862048A1
470	B840126+	REC862048A1
470	-5097479	REC86234A4
470	5097480	REC86234A4
485	5520115 - 6218036	REC86234A4
488	6218037	REC86234A4

MOD.	SERIAL	REF
888 FORD	5685394	REC86234A4
898/198-GM	6170297	REC86234A4
898 GM	3108723	REC62092T
5.7 GM (SKI)	4762210 - 6218461	REC86246T
5.7 GM (SKI)	6218462	REC8M0058164
5.7L BRAVO (GM)350	A338553+	REC8M0058164
7.4L BRAVO GM	B514627+	REC8M0058164
7.4L W/HURTH (IB)	B525982+	REC8M0058164
7.4 BRAVO (GEN V)	B771113+	REC862048A1
7.4 BRAVO (GEN VI)	C391564+	REC862048A1
454 MAG BRAVO MPI (GEN VI) 1996-97		REC861677T

**BOMBA DE COMBUSTIBLE  
ALTA PRESIÓN**

**HIGH PRESSURE FUEL  
PUMP**

**POMPA COMBUSTIBILE  
ALTA PRESSIONE**

**POMPE À CARBURANT  
HAUTE PRESSION**

REF	OEM	
REC861156A1	861156A1	<p>350 Mag M.P.I. Alpha/Bravo/Horizon/MIE/Ski 4.3L EFI/Gen+ TBI/M.P.I. Alpha/Bravo-454 Mag M.P.I. Bravo Et Horizon 5.0/5.7L EFI/M.P.I. Alpha/Bravo-502 Mag M.P.I. 7.4L M.P.I. Bravo Et MIE 8.1L/8.2L MIE M.P.I. MX6.2L M.P.I. Alpha/Bravo/Horizon Et MIE Black Scorpion Scorpion 377 Stendrive Racing</p> <p>(Sin rosca) Reemplaza la bomba de combustible fría (Non threaded) Replaces cool fuel pump (Non filettato) Sostituisce la pompa del carburante fresco (Non fileté) Remplacement de la pompe à carburant froid</p>



REF	OEM	
REC827682T	827682T 827682	<p>262 MAG (TBI) (GEN+) 350 MAG EFI SKY (TBI) GM350 V-8 1994-1996 350MAG MPI SKY GM350 V-8 1995-1996 350 MAG ALPHA EFI (GEN+) GM350 V-8 1996 350 MAG BRAVO MPI GM350 V-8 1995 350 MAG BRAVO MPI (GEN+) GM350 V-8 1996 5.7L ALPHA EFI (TBI) GM350 V-8 1995 5.7L BRAVO (TBI) GM350 V-8 1995 5.7L EFI (2BBL-TBI) GM350 V-8 1996 5.7LX BRAVO EFI (GEN+) GM350 V-8 1996 5.7LX EFI (4BBL-TBI) GM350 V-8 1996</p> <p>OF803800 - OK999999 OF215561 - OF820706 OF350583 - OF799999 OF800300 - OK001508 OF415189 - OF601999 OF602000 - OK001500 OF355305 - OF752389 OF225560 - OF752399 OF752400 - OK001505 OF800300 - OK001508 OF752400 - OK001505</p>



REF	OEM	
REC8M0062770	8M0062770	<p>4.5L MPI (2A456613+) 6.2L MPI (2A449153+)</p>

new

REF	OEM	
REC866169T01	866169T01 305, 350, 377, 496 866169A01 5.0, 5.7, 6.2, 8.1, 8.2, 6.2L	<p>GM V-8 con módulo de alta presión Gen III. GM V-8 with Gen III cool fuel module high pressure. GM V-8 con modulo di alta pressione Gen III. GM V-8 avec module haute pression Gen III.</p>

**BOMBA DE COMBUSTIBLE  
BAJA PRESION**

**LOW PRESSURE FUEL  
PUMP**

**POMPA COMBUSTIBILE  
BASSA PRESSIONE**

**POMPE À CARBURANT  
BASE PRESSION**

REF	OEM	
CARP74021	12 Volt. 4-6PSI /20-30 GPH	

Poseen todas las medidas de seguridad exigidas. Puede usarse para trasvase de gasoil.

Listed by Marine Division UL. Used for diesel fuel transfer  
Conforme con tutte le misure di sicurezza necessarie. Si può utilizzare per travasi di gasolio.

Ils disposent de toutes les mesures de sécurité requises. Peut être utilisé pour le transfert de carburant diesel.



REF	OEM
RECEFP-KT	



REF	OEM		
REC3858261	805656A2	V6 - V8 (Modelo antiguo   Old Model   Modello vecchio   Ancien modèle)	8 PSI 25gpm
	805025A2		
	861155A5	4.3Fi Et Carburated 1992-93 (Bomba en línea   Inline pump model   Pompa in linea   Bomba en línea)	
	805656A6		
	861155A6		



REF	OEM		
REC8M0103289	8M0062771	4.5L MPI (2A456613+) 6.2L MPI (2A449153+)	new



REF	OEM	
REC866170A01	866170A01	305, 350, 377 Et 496 CID

GM V-8 con módulo de baja presión Gen III.  
GM V-8 with Gen III cool fuel module low pressure.  
GM V-8 con modulo di bassa pressione Gen III.  
GM V-8 avec module basse pression Gen III.



REF	OEM		
REC861155A6	861155A6	4.3L V-6	Sustituye modelos antiguos. Replaces old models. Sostituzione vecchi modelli. Remplace les anciens modèles.
	861155A5		
	805656A6		
	805656A2		
	805656A5		
	805025A2		



REF	OEM	
REC861155A3	861155A3 861155A2	4.3, 5.0 / 5.7, 8.1L V6 Et V8



MÓDULO DE COMBUSTIBLE COMPLETO

COMPLETE FUEL MODULE

MODULO CARBURANTE COMPLETO

MODULE DE CARBURANT COMPLET

REF	OEM	
REC8M0047215	8M0047215 864650A13 864650A05	5.7, 6.2, 8.1, 5.0, 8.2 496,350,377,520,540



new

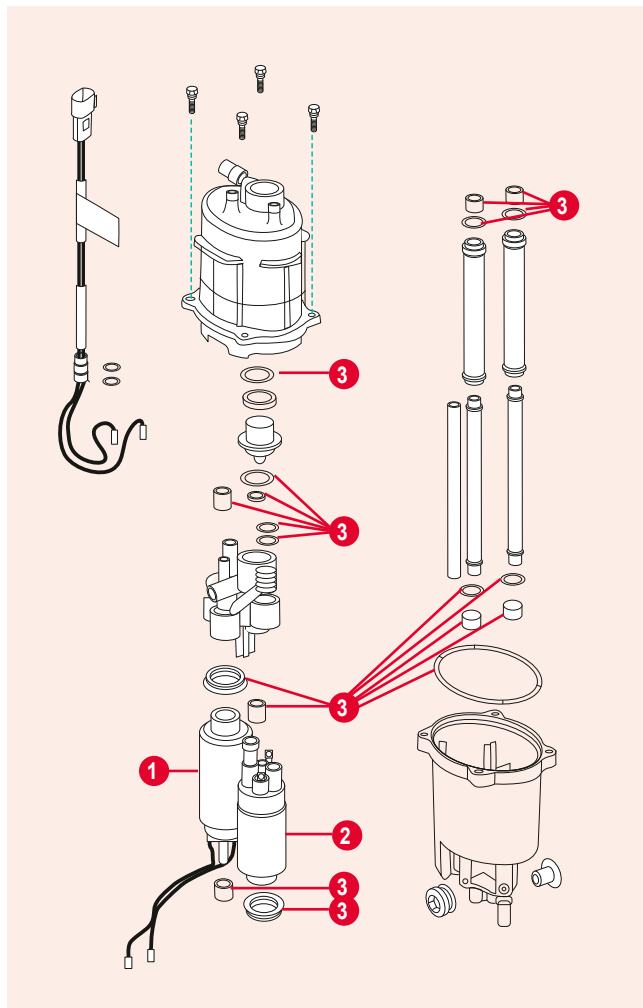
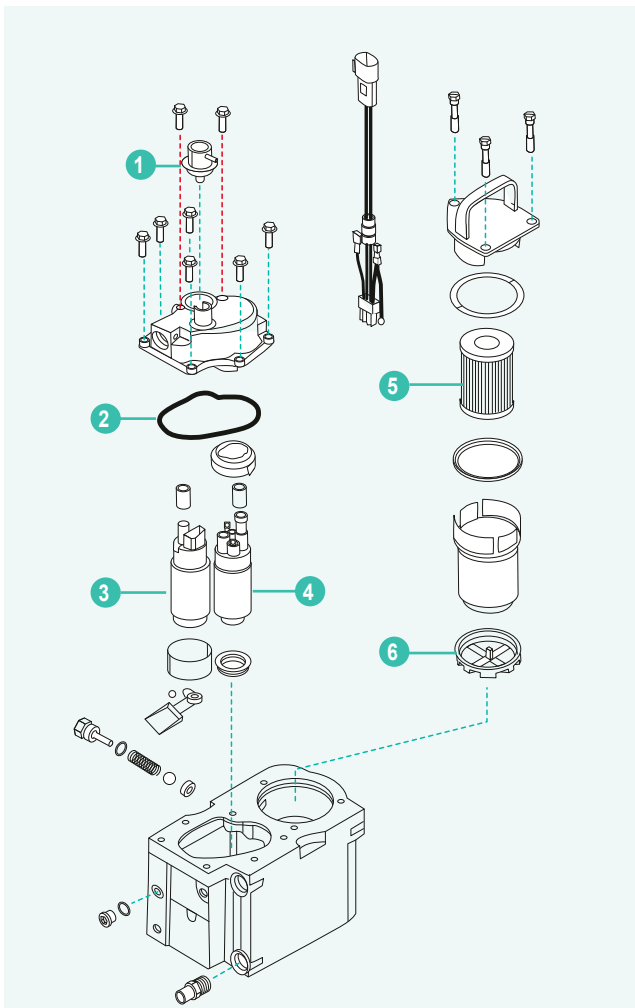

	REF	OEM				
1	REC892681	892681	REGULADOR	REGULATOR	REGOLATORE	REGULATEUR
2	REC26-892683	892683	JUNTA VST	VST GASKET	GUARNIZIONE VST	JOINT VST
3	REC866169T01	866169Y01	BOMBA DE ALTA PRESIÓN	PUMP, HIGH PRESSURE	POMPA ALTA PRESSIONE	POMPE HAUTE PRESSION
4	REC866170A01	866170A01	BOMBA BAJA PRESIÓN	PUMP, LOW PRESSURE	POMPA BASSA PRESSIONE	POMPE BASE PRESSION
5	REC35-866171A01	866171A01	FILTRO	FILTER	FILTRO	FILTRE
6	REC35-892665	892665	FILTRO GASOLINA	FUEL FILTER	FILTRO BENZINA	FILTRE À ESSENCE

	REF	OEM				
1	REC8M0062770	8M0062770	BOMBA DE ALTA PRESIÓN	PUMP, HIGH PRESSURE	POMPA ALTA PRESSIONE	POMPE HAUTE PRESSION
2	REC8M0103289	8M0062771	BOMBA BAJA PRESIÓN	PUMP, LOW PRESSURE	POMPA BASSA PRESSIONE	POMPE BASE PRESSION
3	REC8M0133370		KIT JUNTAS VST	GASKET VST, KIT	KIT GUARNIZIONE VST	KIT JOINTS VST



**BOMBA DE COMBUSTIBLE Y KIT ENFRIADOR**

**ELECTRIC FUEL PUMP & COOLER**

**POMPA BENZINA E KIT SCAMBIATORE**

**POMPE À CARBURANT ET KIT REFROIDISSEUR**

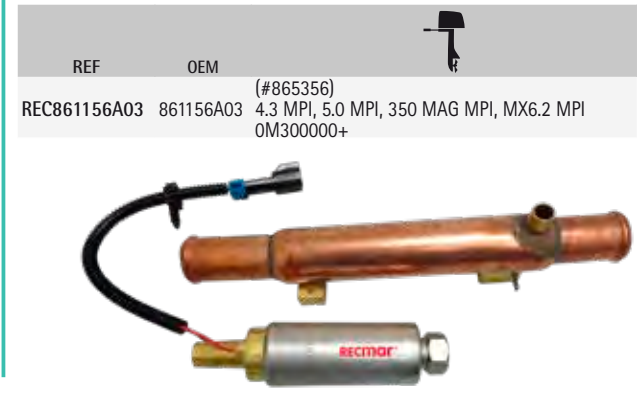

**JUNTAS VST**

**VST GASKETS**

**GUARNIZIONE VST**

**JOINTS VST**

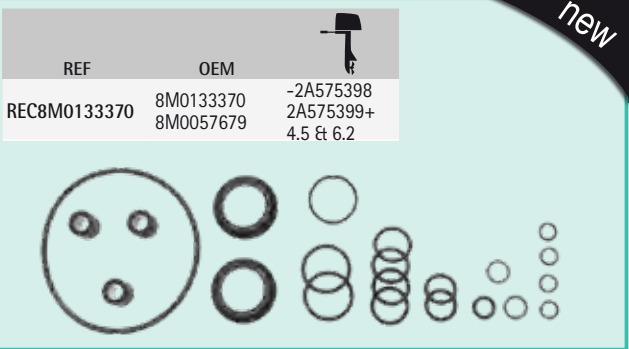
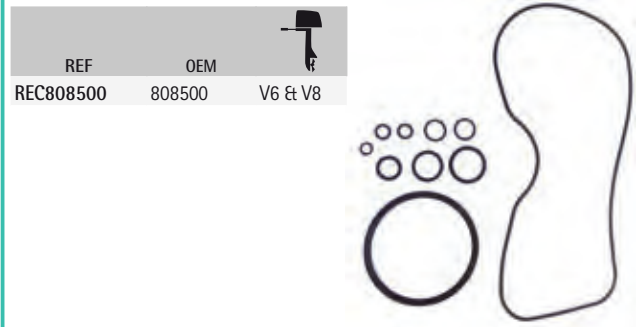
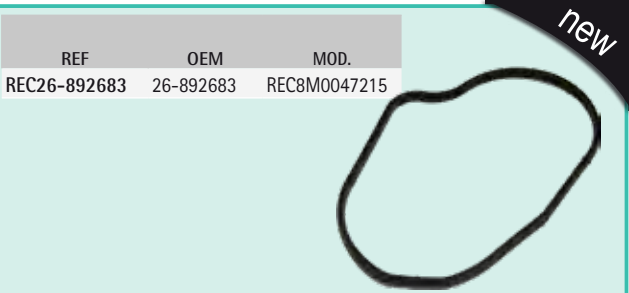

**REGULADOR PRESIÓN DE COMBUSTIBLE**

**FUEL PRESSURE REGULATOR**

**REGOLATORI PRESSIONE CARBURANTE**

**REGULATEUR DE PRESSION DE CARBURANT**

**ENFRIADOR DE COMBUSTIBLE**

**FUEL COOLER**

**SCAMBIATORE DI CALORE**

**REFROIDISSEUR DE CARBURANT**

REF	OEM		
REC802630T01	802630T01 802630001 802630T 802630 8M0069803	MCM/MIE 7.4L MPI (L29) 496 Mag 8.1L	
REC860349A1	860349A1	MCM/MIE 7.4L/LX MPI 454 Mag MPI 502 Mag MPI MIE 8.2L MPI	
REC861126A1	861126A1	MCM 4.3 MPI 5.0 MPI, 350 Magnum, 8.1 L 6.2 MPI 7.4 MPI	MARRÓN, AZUL/VERDE BROWN & BLUE/GREEN MARRONE, BLU/VERDE MARRON, BLEU/VERD
REC807952A1	807952A1	MCM/MIE GM V-6 V-8 305, 350, 377 EFI/MPI, MCM 575SCi	ROSA PINK ROSA ROSE





CARRIL DE COMBUSTIBLE

FUEL RAIL

BINARIO DI ALIMENTAZIONE

RAIL DE CARBURANT

REF	OEM	
REC885174	885174	
REC849899	849899	
REC805227A1	805227A1	

4.3L, 5.0L, 5.7L & 6.2L MPI (555 ECM)  
MCM 500 EFI (Race sterndrive)  
MCM/MIE 7.4L/LX MPI, 454 & 502 Mag MPI, 8.2L MPI

REC885174



REC849899





REC805227A1

TAPA DEL MÓDULO

MODULE COVER

COPERCHIO DEL MODULO

COUVERCLE DU MODULE

REF	OEM		
REC892681	892681		
			5.0L MPI
			5.7L MPI
			350 Magnum
			6.2L MPI
			496 Magnum
			8.1L
			8.2L
			502 Mag MPI
			375HP
425HP			
520, 540 (Race sterndrive)			



INYECTORES

INJEKTOR

INIETTORE



INJECTEURS

INYECTOR

INJEKTOR

INIETTORE



INJECTEUR

REF	OEM	
REC8M6002428	8M6002428 8M6000652 8M0057686	
	4.5L MPI (2A441953+) 6.2L MPI (2A456613+)	

*new*

REF	OEM	
REC885176	885176	
	MCM/MIE 4.3L MPI, 5.0L MPI, 350 Mag MPI, MX 6.2L MPI engines w/ECM555	

REF	OEM	
REC802632T	802632T 802632	
	MCM/MIE 7.4L MPI (L29)	

REF	OEM	
REC3858941	852956A1	
	MCM GM V6 & V8 (305 & 350 cid) TBI	

REF	OEM	
REC881693002	881693002	
	MCM 496 Mag & HQ, MIE 8.1S & HQ	

**KIT RETENES DE INYECTOR**

**FUEL INJEKTOR SEAL KIT**

**KIT PARAOLIO INIETTORE**

**KIT JOINTS D'INJECTEUR**

REF	OEM	
REC9-33304	802632T 849896	802632T Et 849896 MCM/MIE 7.4L MPI (L29)



REF	OEM	
REC9-33301	885176	885176 MCM/MIE 4.3L, 5.0L, 350 Mag MPI, MX 6.2L w/ECM 555



REF	OEM	
REC9-33302	861260T 861260	861260T 350 Mag MPI (1998+) MX 6.2L MPI, 7.4L/502 Mag MPI (1999+) 8.2L MPI



REF	OEM	
REC9-33303	805225A1	805225A1 MCM/MIE Ski GM V-8 350, 377, 454, 502 MPI



REF	OEM	
REC853998A1	853998A1 851956A1 853998T 853998	852956A1 MCM GM V-6 Et V-8 (305 Et 350) TBI



P  
14



REF

STA93008  
STA93016

P  
15



REF

GE22207

CARBURADOR

CARBURATOR

CARBURATORE

CARBURATEUR

CARBURADORES  
REMANUFACTURADOS

REBUILT CARBURATORS

CARBURATORI  
RIGENERATI

CARBURATEURS  
REMANUFACTURÉS

ROCHESTER

REF	OEM	
REC3304-9354A2	3304-9354A2 1347-804623R1/02	4



ROCHESTER

REF	OEM	
REC1347-9661A3	1347-9661A3 1347-8296A4 1347-7361A1 1347-7364A1	4

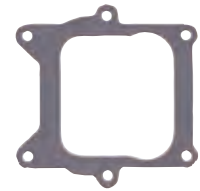

ROCHESTER

REF	OEM	
REC804626R02	1347-8288A1 1347-804626R1 804626R02 1347-6493A1 1347-8291A3 1347-7363A1 1347-7366A	4



ROCHESTER

REF	OEM	
REC1348-818621R02	1348-818621/R02 1347-8186211 1347-818621R02 1351-8480A2	2





ROCHESTER

REF	OEM	Icon
REC1347-818619R02	1347-818619/R02	2
	1347-8186191	
	1351-4263A1	
	1351-7354A1	
	1336-3594A1	
	1351-4263A2/A3	
	1351-5202A1	
	1351-6065A2	



ROCHESTER

REF	OEM	Icon
REC1376-818622R02	1376-818622R02	2
	1347-818622	
	1376-5659A1	
	1347-8186221	
	1376-5744A1	
	1376-6152A1	



ROCHESTER

REF	OEM	Icon
REC3310-807312A1	3310-807312A1	2
	3310-807312R02	
	1389-9670A2	



CARBURADORES NUEVOS NEW CARBURATORS CARBURATORI NUOVI CARBURATEUR NOUVEAU

HOLLEY

REF	Icon	Icon
MP426422	2	4.3L 500 CFM





HOLLEY

REF	Icon	Icon
MP426574	4	5.7 L 600 CFM





HOLLEY

REF		
MP426766	4	7.4 L 750 CFM





Q-JET

REF	OEM		
REC1347-816373A4	1347-816373A4	4	MCM 260, 350 MAG, 5.0L, 5.0LX, 5,7. (1982-95)
	1347-804624R02		
	3310-804624R1		
	1347-6492A1		
	1347-7362A1		
	1347-8292A4		
	1347-9662A4		
1347-9415T			





MERCARB

REF	OEM		
REC3310-864941A01	3310-864941A01	2	4.3L (2002-04) (OM615000- OW300012)





MERCARB

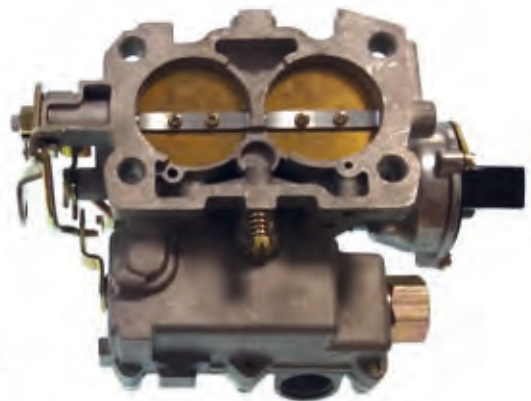

REF	OEM		
REC3310-864943A01	3310-864943A01	2	5.7 GM350 V8 (1998-01) 5.7 CARB ALPHA BRAVO 5.7 CARB MIE 5.7 CARB SKY 5.7 COMPETITION SKI (GEN+) GM 350 V8 (1998) 5.7L 1998+
	3310-861245A1		

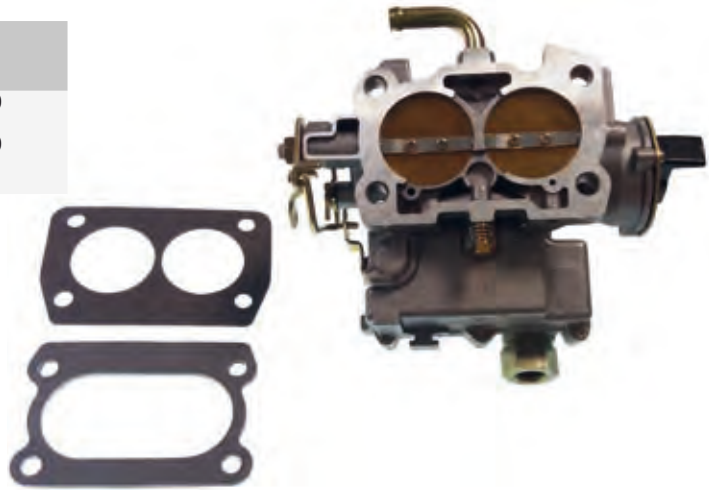

MERCARB

REF	OEM		
REC3310-864942A01	3310-864942A01 3310-861448A1	2	5.0L ALPHA/BRAVO (-OM623982) 5.0L ALPHA/BRAVO (OM623983+) 5.0L (1998-04)



REF	OEM		
REC3310-860070A2	3310-860070A2 1389-9562A1 3310-806077A2 3310-860070A2 3310-9562A1 3310-9350A2 3310-806078A2 3310-815396A2	2	120, 140, 2.5 L & 3.0L

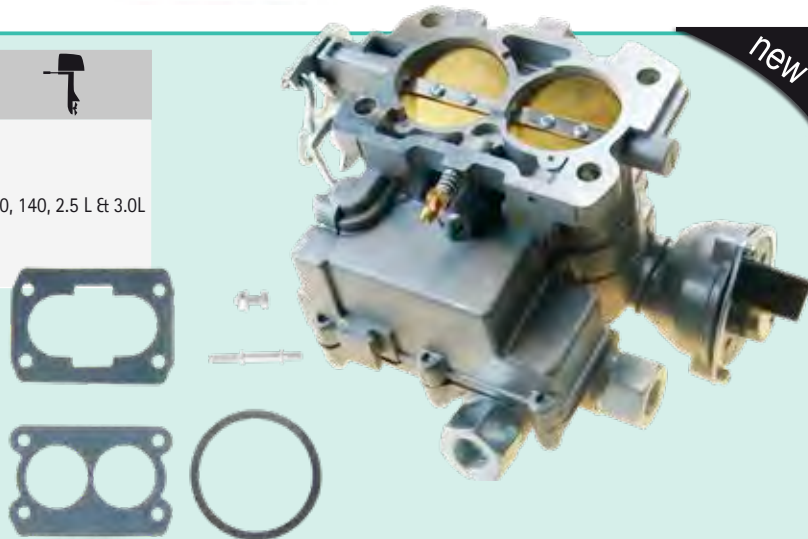

KITS ADAPTADORES CARBURADORES

CARBURETORS ADAPTER KITS

KIT ADATTATORE CARBURATORI

KIT ADPATATEURS DE CARBURATEURS

HOLLEY

REF
RECHOL17-6



CABLE MCM A HOLLEY  
MCM TO HOLLEY CABLE  
CAVI MCM A HOLLEY  
CÂBLE MCM A HOLLEY

REF
RECHOL717-7



TUBO COMBUSTIBLE BOMBA A CARBURADOR

FUEL TUBE FROM PUMP TO CARBURETOR

TUBO DA COMBUSTIBILE A POMPA CARBURATORI



TUYAU CARBURANT, POMPE A CARBURATEUR

REF	
REC18-8115	3/8" x 25 - 5/8"
REC18-8114	3/8" x 31" - 5/8"



BOYAS	FLOATS	GALLEGGIANTI	FLOTEURS												
<b>ROCHESTER</b> <table border="1"> <thead> <tr> <th>REF</th> <th>OEM</th> <th></th> </tr> </thead> <tbody> <tr> <td>REC1397-2060</td> <td>1397-2060</td> <td>2</td> </tr> </tbody> </table> 		REF	OEM		REC1397-2060	1397-2060	2	<b>ROCHESTER</b> <table border="1"> <thead> <tr> <th>REF</th> <th>OEM</th> <th></th> </tr> </thead> <tbody> <tr> <td>REC1397-3327</td> <td>1397-3327 1397-8546 1397-8959</td> <td>4</td> </tr> </tbody> </table> 		REF	OEM		REC1397-3327	1397-3327 1397-8546 1397-8959	4
REF	OEM														
REC1397-2060	1397-2060	2													
REF	OEM														
REC1397-3327	1397-3327 1397-8546 1397-8959	4													

<b>ROCHESTER &amp; MERCAB</b> <table border="1"> <thead> <tr> <th>REF</th> <th>OEM</th> <th></th> </tr> </thead> <tbody> <tr> <td>REC3302-9031</td> <td>1397-5837 3302-9031</td> <td>2</td> </tr> </tbody> </table> 		REF	OEM		REC3302-9031	1397-5837 3302-9031	2	<b>WEBER</b> <table border="1"> <thead> <tr> <th>REF</th> <th>OEM</th> <th></th> </tr> </thead> <tbody> <tr> <td>REC811536T</td> <td>811536T 811536</td> <td>4</td> </tr> </tbody> </table> 		REF	OEM		REC811536T	811536T 811536	4
REF	OEM														
REC3302-9031	1397-5837 3302-9031	2													
REF	OEM														
REC811536T	811536T 811536	4													

KIT AGUJAS	INLET NEEDLE KIT	KIT SPILLO	KIT POINTEAU												
<b>WEBER</b> <table border="1"> <thead> <tr> <th>REF</th> <th>OEM</th> <th></th> </tr> </thead> <tbody> <tr> <td>REC823727</td> <td>823727</td> <td>V6</td> </tr> </tbody> </table> 		REF	OEM		REC823727	823727	V6	<b>MERCAB</b> <table border="1"> <thead> <tr> <th>REF</th> <th>OEM</th> <th></th> </tr> </thead> <tbody> <tr> <td>REC3302-804689</td> <td>3302-804689</td> <td>Moderno New style Modello moderno Model moderne</td> </tr> </tbody> </table> 		REF	OEM		REC3302-804689	3302-804689	Moderno New style Modello moderno Model moderne
REF	OEM														
REC823727	823727	V6													
REF	OEM														
REC3302-804689	3302-804689	Moderno New style Modello moderno Model moderne													
<b>WEBER</b> <table border="1"> <thead> <tr> <th>REF</th> <th>OEM</th> <th></th> </tr> </thead> <tbody> <tr> <td>REC811534</td> <td>811534</td> <td>V8</td> </tr> </tbody> </table> 		REF	OEM		REC811534	811534	V8								
REF	OEM														
REC811534	811534	V8													
<b>MERCAB</b> <table border="1"> <thead> <tr> <th>REF</th> <th>OEM</th> <th></th> </tr> </thead> <tbody> <tr> <td>REC3302-9407</td> <td>3302-9407</td> <td>Antiguo Old style Modello vecchio Ancien model</td> </tr> </tbody> </table> 		REF	OEM		REC3302-9407	3302-9407	Antiguo Old style Modello vecchio Ancien model								
REF	OEM														
REC3302-9407	3302-9407	Antiguo Old style Modello vecchio Ancien model													



REF  
GEGC15





**JUNTAS DE CARBURADOR CARBURETOR GASKETS**

REF	OEM
REC27-48399	27-48399

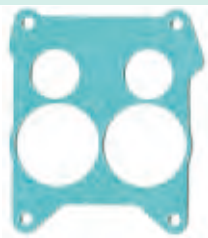

REF	OEM	
REC27-805396	27-805396	5.7L & 7.4L MPI



**ROCHESTER**

REF	OEM	
REC27-64692	27-64692	4

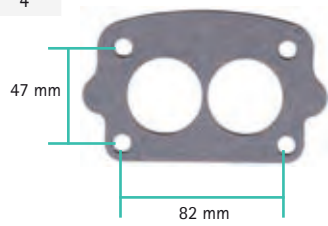

**GUARNIZIONE CARBURATORI**

**HOLLEY**

REF	OEM	
REC27-65577	27-65577	4
REC27-41609	27-41609	4
REC27-70142	27-70142	2
REC27-60715	27-60715	2

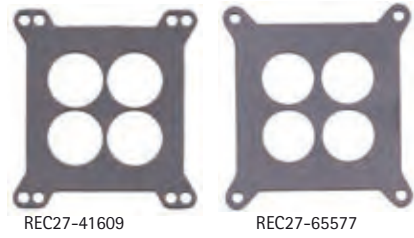

**ROCHESTER & WEBER**

REF	OEM	
REC27-524572	27-524572	4
REC27-8079821	8079821 27-8079821 27-70143 27-701431 27-807982	2

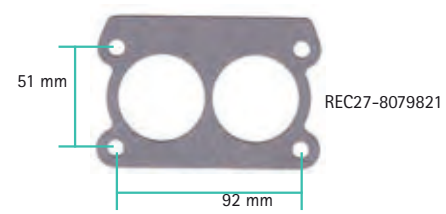

**KIT JUNTAS DE CARBURADOR**

REF	OEM
REC823427A1	823427A1
	1397-8873
	1397-8872
	1397-7547
	1397-7542
	1397-3459
	1397-2634
	1397-2067

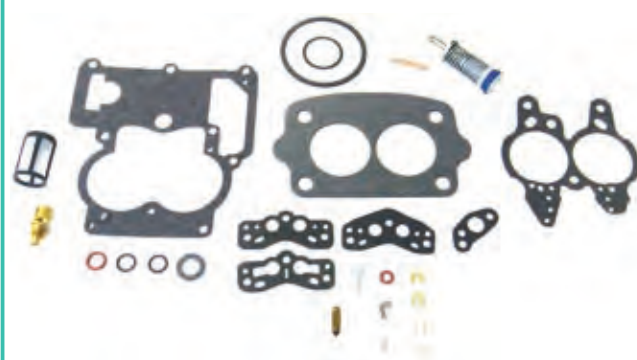

**CARBURETOR GASKETS KIT**

**KIT GUARNIZIONE CARBURATORI**

REF	OEM
REC1397-8760	1397-8760 1397-5830 1397-7099

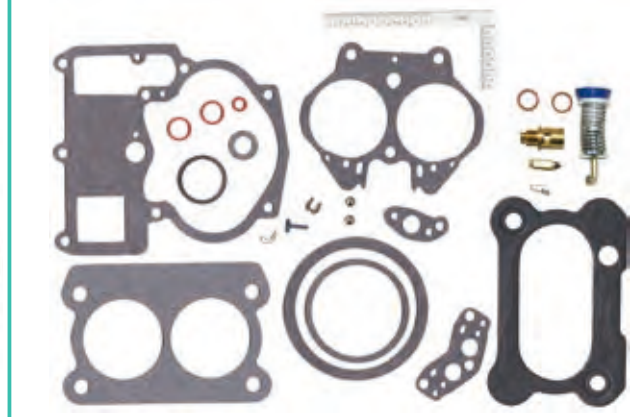

**KIT JOINTS CARBURATEURS**

REF	OEM
REC1397-6367A1	1397-6367A1

REF	OEM
REC1398-3089	1398-3089 1346-2770

REF	OEM
REC1396-4656	1396-4656

REF	OEM
REC13220	13220

**WEBER**

REF	OEM	Quantity
REC809064	809064	4
REC809065	809065 835076 823728	4

**MERCAB**

REF	OEM
REC3302-804845	3302-9437 3302-804845

**MERCAB**



**FORD + ROCHESTER**

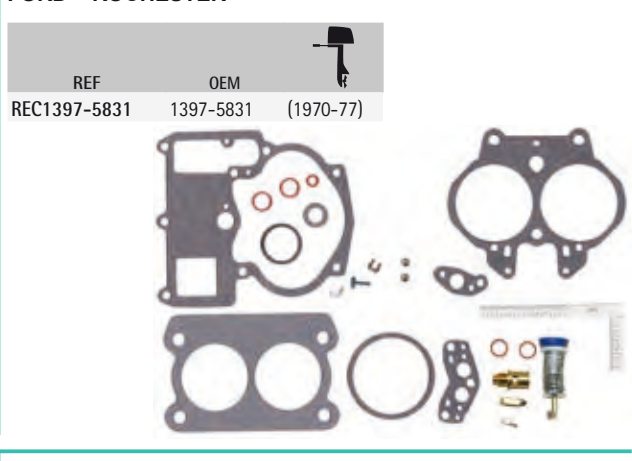

**FORD**

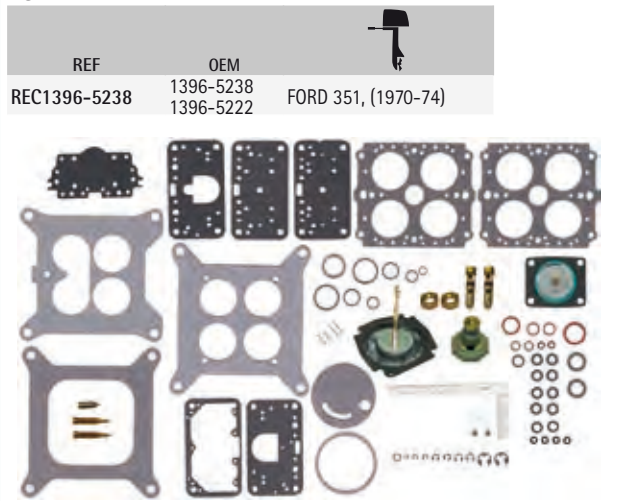

**ROCHESTER**

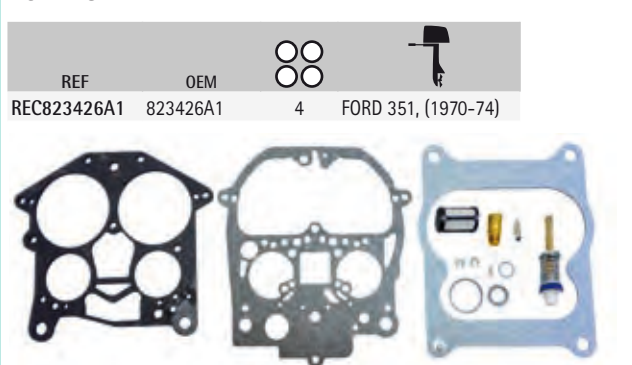

**GUÍA CARBURADORES**





**GUIDE CARBURETORS**

**GUIDA CARBURATORI**



**GUIDE DES CARBURATEURS**

Icon	Icon	SERIE SERIAL	CARB.	KIT CARB.	BASE	KIT	Icon
<b>ROCHESTER</b>							
90/ L4	2	1970-72	2851424-3226957	REC1347-818619R02	REC823427A1	REC27-64692	REC1397-2060
110/ L4	2	1963-66	1357370-2044033	REC1347-818619R02	REC823427A1	REC27-64692	REC1397-2060
120/ L4	2	1972-82	3377341-6229717	REC1347-818619R02	REC823427A1	REC27-64692	REC1397-2060
120/2.5L L4	2	1983-89	6229718-0C853255	REC1347-818619R02	REC823427A1	REC27-64692	REC1397-2060
120 (GM153) L4	2	1983-86	6229718-0B531853	REC1348-818621R02	REC823427A1	REC27-64692	
140 (GM181) L4	2	1982-86	6229718-0B450800	REC1348-818621R02	REC823427A1	REC27-64692	
140 (GM181) L4	2	1968-78	02816417-09999999		REC823427A1	REC27-64692	REC1397-2060
140 (GM181) L4	2	1979-82	5157669-6229717		REC823427A1	REC27-64692	REC1397-2060
2.5L (GM153) L4	2	1987-89	0B531854-0C856558	REC1348-818621R02	REC823427A1	REC27-64692	
3.0L (GM181) L4	2	1987-89	0B450801-0C856558	REC1348-818621R02	REC823427A1	REC27-64692	
205 (4.3L/LX)	4	1987	0B527955-0B775129	REC3304-9354A2	REC823426A1	REC27-524572	REC1397-3327
205 (4.3L)	4	1985-87	0A331455-0B527954	REC3304-9354A2	REC823426A1	REC27-524572	REC1397-3327
4.3L /LX	4	1988-92	0B775130-0D714106	REC3304-9354A2	REC823426A1	REC27-524572	REC1397-3327
898/200/5.0L	2	1987-95	0B525982-0F600999	REC3310-807312A1	REC3302-804845	REC27-8079821	REC3302-9031
228 (GM305)	4	1977-84	4765100-0B525981	REC1347-9661A3	REC823426A1	REC27-524572	REC1397-3327
228 MIE (GM305)	4	1977-80	4765100-5907057	REC1347-9661A3	REC823426A1	REC27-524572	REC1397-3327
230 MIE (GM305)	4	1987-95	0B522506-0B788151	REC1347-9661A3	REC823426A1	REC27-524572	REC1397-3327
230 (GM305)	4	1985-87	6218462-0B773799	REC1347-9661A3	REC823426A1	REC27-524572	REC1397-3327
5.0LX (GM305)	4	1988-95	0B773740-0F600999	REC1347-9661A3	REC823426A1	REC27-524572	REC1397-3327
233 (351) FORD	2	1975-77	00000000-09999999	REC1376-818622R02	REC1397-8760	REC27-70142	REC3302-9031
233 MIE (351) FORD	2	1975-76	00000000-09999999	REC1376-818622R02	REC1397-8760	REC27-70142	REC3302-9031
888 (302) FORD	2	1971-77	3108723	REC1376-818622R02	REC1397-8760	REC27-70142	REC3302-9031
5.7L (2BBL)	2	1996-97	F601000-K999999	REC3310-807312A1	REC3302-804845	REC27-8079821	REC3302-9031
5.7L SKI	2	1996-97	0F775200-0K999999	REC3310-807312A1	REC3302-804845	REC27-8079821	REC3302-9031
260/5.7MIE	4	1987-93	0B522506-0F024999	REC1347-816373A4	REC823426A1	REC27-524572	REC1397-3327
260	4	1978-86	4908850-0B525981	REC1347-816373A4	REC823426A1	REC27-524572	REC1397-3327
260/5.7L ALPHA	4	1987-93	0B525982-0F000454	REC1347-816373A4	REC823426A1	REC27-524572	REC1397-3327
5.7L BRAVO (w/o High Rise Intake)	4	1987-91	0B525982-0D617327	REC1347-816373A4	REC823426A1	REC27-524572	REC1397-3327









		SERIE SERIAL	CARB.	KIT CARB.	 BASE	 KIT	
5.7L SKI	4	1985-93 0A338533-0F025099	REC1347-816373A4	REC823426A1	REC27-524572		REC1397-3327
300MR/TRS	4	1985-86 6668677-0B430367	REC1347-816373A4	REC823426A1	REC27-524572		REC1397-3327
330 MCM	4	1977-87 4623115-0B816540	REC804626R02	REC823426A1	REC27-524572		REC1397-3327
330 MIE	4	1977-80 4623115-5889913	REC804626R02	REC823426A1	REC27-524572		REC1397-3327
340/7.4L MIE	4	1981-92 5889914-0D715493	REC804626R02	REC823426A1	REC27-524572		REC1397-3327
7.4L BRAVO I/II	4	1988-91 0B771113-0D603117	REC804626R02	REC823426A1	REC27-524572		REC1397-3327
454 MAG ALPHA	4	1986-88 0A631894-0B785148	REC804626R02	REC823426A1	REC27-524572		REC1397-3327
<b>MERCARB &amp; WEBER</b>							
120 (CID 153/ CYL L4)		1984	REC3310-860070A2	REC3302-804845		REC3302-9407	
120 (CID 153/ CYL L4)		1985	REC3310-860070A2	REC3302-804845		REC3302-9407	
120 (CID 153/ CYL L4)		1986	REC3310-860070A2	REC3302-804844002		REC3302-9407	
2.5L (CID 153/ CYL L4)		1987-89	REC3310-860070A2	REC3302-804844002		REC3302-9407	
140 (CID 181/ CYL L4)		1984	REC3310-860070A2	REC3302-804845		REC3302-9407	
140 (CID 181/ CYL L4)		1985	REC3310-860070A2	REC3302-804845		REC3302-9407	
140 (CID 181/ CYL L4)		1986	REC3310-860070A2	REC3302-804844002		REC3302-9407	
3.0L (CID 181/ CYL L4)		1987-89	REC3310-860070A2	REC3302-804844002		REC3302-9407	
3.0L (CID 181/ CYL L4)		1990	REC3310-860070A2	REC3302-804844002		REC3302-804689	
3.0L (CID 181/ CYL L4)		1991-93	REC3310-860070A2	REC3302-804844002		REC3302-804689	
3.0L (CID 181/ CYL L4)		1993-94	REC3310-860070A2	REC3302-804844002		REC3302-804689	
4.3LH (GEN+)	4	1998 0L010044-0M614999		REC809065	REC27-524572	REC823727	REC811536T
4.3L CARB ALPHA/BRAVO	2	0M615000-0W300012	REC3310-864941A01	REC3302-804844002	REC27-8079821	REC3302-804689	REC3302-9031
5.0L CARB ALPHA/BRAVO	2	0M600000 +	REC3310-864942A01	REC3302-804844002	REC27-8079821	REC3302-804689	REC3302-9031
5.0L GM305 V-8	2	1998 0L015751-0M599999	REC3310-864942A01	REC3302-804844002	REC27-8079821	REC3302-804689	REC3302-9031
5.7 CARB ALPHA/BRAVO	2	0M600000 +	REC3310-864943A01	REC3302-804844002	REC27-8079821	REC3302-804689	REC3302-9031
5.7L CARB MIE	2	0L002003-0W090899	REC3310-864943A01	REC3302-804844002	REC27-8079821	REC3302-804689	REC3302-9031
5.7L CARB SKY	2	0M317000-0W090899	REC3310-864943A01	REC3302-804844002	REC27-8079821	REC3302-804689	REC3302-9031
5.7L GM350V-8	2	1998-01 0L010037-0M599999	REC3310-864943A01	REC3302-804844002	REC27-8079821	REC3302-804689	REC3302-9031
5.7L COMPETITON SKY(GEN+)	2	1998 0L002005-0M316999	REC3310-864943A01	REC3302-804844002	REC27-8079821	REC3302-804689	REC3302-9031
7.4L MIE	4	1995-97 0F350000-0K999999		REC809064	REC27-41609	REC811534	REC811536T
7.4L BRAVO I/II	4	1995-97 0F352000-0K999999		REC809064	REC27-41609	REC811534	REC811536T
7.4L BRAVO III	4	1996-97 0F800700-0K999999		REC809064	REC27-41609	REC811534	REC811536T
<b>TKS</b>							
5.0L CARB ALPHA/BRAVO	2	0M600000-0W300009		REC3302-804844002	REC27-8079821	REC3302-804689	REC3302-9031
5.0L CARB ALPHA/BRAVO	2	0W300010 +		REC3302-804844002	REC27-8079821	REC3302-804689	REC3302-9031
5.7L CARB ALPHA/BRAVO	2	0M600000-0W300009		REC3302-804844002	REC27-8079821	REC3302-804689	REC3302-9031
5.7L CARB ALPHA/BRAVO	2	0W300010 +		REC3302-804844002	REC27-8079821	REC3302-804689	REC3302-9031
5.7 CARB MIE	2	0M317000-0W689999		REC3302-804844002	REC27-8079821	REC3302-804689	REC3302-9031
5.7 CARB MIE	2	0W690000 +		REC3302-804844002	REC27-8079821	REC3302-804689	REC3302-9031
5.7 CARB SKY	2	0M317000-0W689999		REC3302-804844002	REC27-8079821	REC3302-804689	REC3302-9031
5.7 CARB SKY	2	0W694844 +		REC3302-804844002	REC27-8079821	REC3302-804689	REC3302-9031

**GUÍA KIT CARBURADORES    GUIDE CARBURETORS KIT    GUIDA KIT CARBURATORI    GUIDE DES KIT CARBURATEURS**

	SERIE	OEM	CARB	KIT		 BASE	 KIT
MCM 120/2.5L	2520425-3377340	1336-3594A1	R2/2GC		REC1397-2060	REC27-64692	
	337341-3770649	1351-4263A3	R2/2GC	REC823427A1	REC1397-2060	REC27-64692	
	3770650-4469865	1351-5202A1	R2/2GC	REC823427A1	REC1397-2060	REC27-64692	
	4469866-5192048	1351-6065A2	R2/2GC	REC823427A1	REC1397-2060	REC27-64692	
	5192049-6229717	1351-7354A1	R2/2GC	REC823427A1	REC1397-2060	REC27-64692	
	6229718-0C853255	1351-8480A2	R2/2GC	REC823427A1		REC27-64692	
	6229718-0C853255	1389-8490A2	M2/MERCARB	REC3302-804844002	REC3302-9031	REC27-8079821	REC3302-9407
	6229718-0C853255	1389-9350A2	M2/MERCARB	REC3302-804844002	REC3302-9031	REC27-8079821	REC3302-9407
	6229718-0C853255	1389-9562A1	M2/MERCARB	REC3302-804844002	REC3302-9031	REC27-8079821	REC3302-9407
	2816417-2911439	1351-4032A1	R2/2GC	REC823427A1	REC1397-2060	REC27-64692	
	2911440-3771644	1351-4293A1	R2/2GC	REC823427A1	REC1397-2060	REC27-64692	
	3771645-5157668	1351-5203A1	R2/2GC	REC823427A1	REC1397-2060	REC27-64692	
MCM 140/3.0L/3.0LX (4 Cil.)	5157669-6229717	1351-7355A1	R2/2GC	REC823427A1	REC1397-2060	REC27-64692	
	6229718-0C856556	1351-8480A2	R2/2GC	REC823427A1		REC27-64692	
	6229718-0C856556	1389-8490A2	M2/MERCARB	REC3302-804844002	REC3302-9031	REC27-8079821	REC3302-9407
	6229718-0C856556	1389-9350A2	M2/MERCARB	REC3302-804844002	REC3302-9031	REC27-8079821	REC3302-9407
	6229718-0C856556	1389-9562A1	M2/MERCARB	REC3302-804844002	REC3302-9031	REC27-8079821	REC3302-9407
	0C856559-0D447414	1389-815396A2	M2/MERCARB				
	0D447415-0D836075	1389-9562A1	M2/MERCARB	REC3302-804844002	REC3302-9031	REC27-8079821	REC3302-9407
	0D836076-0F603999	1389-815396A2	M2/MERCARB				
LX 0C856559+	1389-815397A2	M2/MERCARB					



	SERIE	OEM	CARB	KIT		 BASE	 KIT
MCM 165/170/3.7L (4 Cil.)	6916779	1389-9564A1	M2/MERCARB	REC3302-804844002	REC3302-9031	REC27-8079821	REC3302-9407
MCM470	4208730-6916778 6218037-6916778	1376-5990A1 1389-8489A5	R2/2GC M2/MERCAB	REC823427A1 REC3302-804844002	REC3302-9031 REC3302-9031	REC27-8079821 REC27-8079821	REC3302-804689
MCM185 (229CID)	6330183-6919655	3300-8886A 2	R4/4ME	REC823426A1	REC1397-2060	REC27-524572	
MCM485	5688394-6218036	1376-5990A1	R2/2GC	REC823427A1	REC3302-9031	REC27-64692	
MCM180/190/3.7LX	6916779	1347-9142A2	R4/4ME	REC823426A1	REC1397-3327	REC27-524572	
MCM488	6170297-6916778	1347-8460A3	R4/4ME	REC823426A1	REC1397-3327	REC27-524572	
MCM 175/185/4.3L V6	0A221455-0B527954 0A221455-0D714106 0F000878+	3304-9353A2 3304-9565A1 3310-80776A1	M2/MERCARB M2/MERCARB M2/MERCARB	REC3302-804845 REC3302-804844002 REC3302-804844002	REC3302-9031 REC3302-9031 REC3302-9031	REC27-8079821 REC27-8079821 REC27-8079821	REC3302-9407 REC3302-9407 REC3302-804689
MCM205/ 4.3LX/ 4.3LXH/LHV6	0A331455-0D714369 0D714370-0F802999	3304-9354A2 3310-807826A1	R4/4MV WEBER	REC823426A1 REC809064	REC1397-3327 REC811536T	REC27-524572 REC27-524572	REC823727
MCM198MIE/898-V8	4762210-0B525981	1376-8295A3	R2/2GC	REC1397-5831	REC3302-9031	REC27-8079821	
MCM898/200 V8	6218462-0B525981	1389-9563A1	M2/MERCARB	REC3302-804844002	REC3302-9031	REC27-8079821	REC3302-9407
MCM200/5.0L V8	0B525982-0F600999	1389-9670A2	M2/MERCARB	REC3302-804844002	REC3302-9031	REC27-8079821	REC3302-804689
MCM5.0L (GENE+) V8	0L157751+	3310-861448A1	M2/MERCARB		REC3302-9031	REC27-8079821	REC3302-804689
MCM888 V8	3108723-4887829 3108723-4887829	1356-4642 1376-5659A1	H2/2300 R2/2GC	REC1396-4656 REC1397-5831	REC3302-9031	REC27-60715 REC27-8079821	
MCM228/TR/MIE V8	4765100-5069430 4765100-5069430	1347-6427A1 1347-6438A1	R4/4MV R4/4MV	REC823426A1 REC823426A1	REC1397-3327 REC1397-3327	REC27-524572 REC27-524572	
MCM228V8	5069431-6021783 6021784-6218461	1347-7361A1 1347-8296A4	R4/4MV R4/4MV	REC823426A1 REC823426A1	REC1397-3327 REC1397-3327	REC27-524572 REC27-524572	
MCM228/230/5.0LX	6218462-0F600999	1347-9661A3	R4/4MV	REC823426A1	REC1397-3327	REC27-524572	
MCM228MIE V8	5069431-6040745	1347-7364A1	R4/4MV	REC823426A1	REC1397-3327	REC27-524572	
MCM230MIE V8	6040746-0B788151	1347-8290A1	R4/4MV	REC823426A1	REC1397-3327	REC27-524572	
MCM233/MIE V8	4173000-4465029 4465030-4902304	1346-57744A1 1346-6152A2	R2/2GC R2/2GC	REC1397-5831 REC1397-5831	REC3302-9031 REC3302-9031	REC27-8079821 REC27-8079821	
MCM250 (350CID) V8	4768000-4908849 4768000-4908849	1347-3353 1347-3237A3	R4/4MV R4/4MV	REC823426A1 REC823426A1	REC1397-3327 REC1397-3327	REC27-48399 REC27-48399	
MCM255/MIE (Ford)	3258728-4175499	1356-5169	H4/4160	REC17-8M0065070		REC17-14872A1	
MCM255/MIE V8	4175500-4924564 4924565-5195908 5195909-5907057	1347-5732A1 1347-7062A1 1347-7365A1	R4/4MV R4/4MV R4/4MV	REC823426A1 REC823426A1 REC823426A1	REC1397-3327 REC1397-3327 REC1397-3327	REC27-524572 REC27-524572 REC27-524572	
MCM260MIE V8	5907058-0B522505	1347-8289A1	R4/4MV	REC823426A1	REC1397-3327	REC27-524572	
MCM260MIE/ 5.7MIE	0B522506-0F024999 0F025000-0F349299	1347-9662A4 3310-806761A1	R4/4MV WEBER	REC823426A1 REC811536T	REC1397-3327 REC811536T	REC27-524572 REC27-524572	REC811534
MCM5.7MIE V8	0F025000-0F349299 0F025000-0F349299 0F349300-0F622099 0F622100-0K999999	3310-806761A2 3310-806761A3 3310-806762A2	WEBER WEBER WEBER		REC811536T REC811536T REC811536T	REC27-524572 REC27-524572 REC27-524572	REC811534 REC811534 REC811534
MCM5.7MIE (2BBL) 255 V8	0L002003+ 4175500-4767999	3310-861245A1 1347-5732A 1	MERCARB R4/4MV		REC3302-9031 REC1397-3327	REC27-8079821 REC27-524572	REC3302-804689
260 V8	4908850-5060805 5060806-6024393	1347-6492A 1 1347-7362A 1	R4/4MV R4/4MV	REC823426A1 REC823426A1	REC1397-3327 REC1397-3327	REC27-524572 REC27-524572	
260 V8/5.7L Alpha	6024393-0B525981	1347-8292A 1	R4/4MV	REC823426A1	REC1397-3327	REC27-524572	
5.7L Alpha V8	0B525982-0F000454 0F000455-0F273497 0F273498-0F600999	1347-9662A 4 3310-806761A 1 3310-806761A 3	R4/4MV WEBER WEBER	REC823426A1	REC1397-3327	REC27-524572 REC27-524572 REC27-524572	REC811534 REC811534 REC811534
5.7L (2BBL) V8	0F601000-0K999999	3310-807312A 1	MERCARB			REC27-8079821	REC3302-804689
5.7L (Gen+) (2BBL)	0L010037+	3310-861245A1	MERCARB			REC27-8079821	REC3302-804689
5.7LX (4BBL) V8	0F601000-0K999999	3310-807262A 2	WEBER			REC27-524572	REC811534
5.7L Bravo V8	0B525982-0D617327 0B525982-0D617327 0B525982-0D617327	1347-9662A 4 1347-8289A 1 3310-806970A 1	R4/4MV R4/4MV WEBER	REC823426A1 REC823426A1	REC1397-3327 REC1397-3327	REC27-524572 REC27-524572 REC27-524572	REC811534
350 Magnum Alpha	0A635178-0D617327 0D617328-0F600999 0F601000-0K999999	1347-8289A 1 3310-806970A 1 3310-807262A 2	R4/4MV WEBER WEBER	REC823426A1	REC1397-3327	REC27-524572 REC27-524572 REC27-524572	REC811534 REC811534 REC811534
5.7L Ski V8	0A338533-0F025099 0F025100-0F449999 0F450000-0F775199	1347-9415T 3310-806761A 2 3310-806761A 3	R4/4MV WEBER WEBER	REC823426A1	REC1397-3327 REC811536T	REC27-524572 REC27-524572 REC27-524572	REC811534 REC811534 REC811534
5.7L Ski (2BBL) V8	0F775200-0K999999	3310-807312A 1	MERCARB		REC3302-9031	REC27-8079821	REC3302-804689
5.7L Ski (Gen+) (2BBL) V8	0L002005+	3310-861245A 1	MERCARB		REC3302-9031	REC27-8079821	REC3302-804689
350 MAG Ski V8	0D505450-0K999999 0K040400-0K999999	3310-807262A 2 3310-860371A 1	WEBER WEBER		REC811536T REC811536T	REC27-524572 REC27-524572	REC811534 REC811534
270 MCM/MIE V8	2851074-3385720	1347-4180A 1	R4/4MV	REC823426A1	REC1397-3327	REC27-524572	
280 TRS V8	4176250-4176468 4176469-4770199	1347-4179A 2 1347-5981A 1	R4/4MV R4/4MV	REC823426A1 REC823426A1	REC1397-3327 REC1397-3327	REC27-524572 REC27-524572	
300 MR/TRS V8	6668677-0B430367 2278747-3042730	1347-7498A 7 1347-3342	R4/4MV R4/4MV	REC823426A1 REC823426A1	REC1397-3327 REC1397-3327	REC27-524572 REC27-524572	
325 MCM/MIE V8	3042731-3780449 2278747-3080449	1347-4533A 1 1347-3689A 1	R4/4MV R4/4MV	REC823426A1 REC823426A1	REC1397-3327 REC1397-3327	REC27-524572 REC27-524572	

	SERIE	OEM	CARB	KIT		 BASE	 KIT
330 MCM V8	4623115-5027230	1347-6493A 1	R4/4MV	REC823426A1	REC1397-3327	REC27-524572	
	5027231-6083144	1347-7363A 1	R4/4MV	REC823426A1	REC1397-3327	REC27-524572	
	6083145-0816540	1347-8291A 3	R4/4MV	REC823426A1	REC1397-3327	REC27-524572	
330 MIE V8	4623115-5226384	1347-6493A 1	R4/4MV	REC823426A1	REC1397-3327	REC27-524572	
	5226385-5889913	1347-7366A 1	R4/4MV	REC823426A1	REC1397-3327	REC27-524572	
340/7.4L MIE V8	5889914-0D715493	1347-8288A 1	R4/4MV	REC823426A1	REC1397-3327	REC27-524572	
7.4L Hurth V8	0D715494-0F349999	3310-80969A 2	WEBER		REC811536T	REC27-524572	REC811534
7.4L BORG WARNER V8	0D715494-0F349999	3310-80969A 3	WEBER		REC811536T	REC27-524572	REC811534
7.4L MIE V8	0F350000-0K999999	3310-86969A 1	WEBER		REC811536T	REC27-524572	REC811534
	0B771113-0D603117	1347-8291A 3	R4/4MV	REC823426A1	REC1397-3327	REC27-524572	
7.4L BRAVO I/II V8	0D603118-0F351999	3310-86969A 2	WEBER		REC811536T	REC27-524572	REC811534
	0F352000-0K999999	3310-86969A 1	WEBER		REC811536T	REC27-524572	REC811534
	0D838819-0F800699	3310-806755A 2	WEBER		REC811536T	REC27-524572	REC811534
7.4L BRAVO III V8	0F800700-0K999999	3310-806969A 1	WEBER		REC811536T	REC27-524572	REC811534
	4179554-0B714586	1347-7498A 2	R4/4MV	REC823426A1	REC1397-3327	REC27-524572	
370 V8	4179554-0B714586	1347-7498A 2	R4/4MV	REC823426A1	REC1397-3327	REC27-524572	
400 V8	TODOS - All	1347-7498A 2	R4/4MV	REC823426A1	REC1397-3327	REC27-524572	
420/425 V8	0A398941-0D937011	13549A 4	H4	REC13220			
440/460 V8	4179554-0B485220	1393-8862A 1	H4	REC13220			
450 V8	0F347100-0F347277	13549A 4	H4	REC13220			
454 MAG Alpha V8	0A631894-0B785148	1347-8291A 3	R4/4MV	REC823426A1	REC1397-3327	REC27-524572	
	0A631894-0B785148	1347-8291A 3	R4/4MV	REC823426A1	REC1397-3327	REC27-524572	
	0B721206-0D808068	1347-7498A 2	R4/4MV	REC823426A1	REC1397-3327	REC27-524572	
454 MAG Bravo V8	0D808069-0F304999	3310-806755A 1	WEBER		REC811536T	REC27-524572	REC811534
	0F305000-0K999999	3310-806755A 2	WEBER		REC811536T	REC27-524572	REC811534
465 V8	0C849992-0F213244	N/D	H4	REC13220			
500 (502 CID) V8	0F213293-0F615766	13549A12	H4	REC13220			
	0F615767+	13549T21	H4	REC13220			
500 Bulldog (540 CID) V8	0C577254-0F348987	13549A10	H4	REC13220			
	0F615767+	13549A23	H4	REC13220			
502 MAG V8	0C878221-0D824588	1347-814623A 2	R4/4MV	REC823426A1	REC1397-3327	REC27-524572	
	0D824589-0F114528	3310-806971A 1	WEBER		REC811536T	REC27-524572	REC811534
8.2L MIE V8	0C878221-0D857199	1347-814623A 2	R4/4MV	REC823426A1	REC1397-3327	REC27-524572	
	0D878221-0F819619	3310-806971A 1	WEBER		REC811536T	REC27-524572	REC811534





**CHOKE**

REF	OEM	
REC1396-4148	1396-4148 HOLLEY	
REC809066	809066 WEBER 4v Carb (electric choke)	
REC70125A02	70125A02	
	70125A1 ROCHESTER & MERCAB	
70125		



REC809066  
REC1396-4148

REC70125A02

DEPRESOR	CHOKE PULL-OFF	DEPRESSORE	ÉTRANGLEMENT PULL-OFF	TERMOSTATO	THERMOSTAT	TERMOSTATO	THERMOSTAT
							
REF	OEM			REF	OEM		
REC1397-8582	1397-8582 Rochester, 4v carb.			REC71464A01	71464 71464A01 72625 Rochester (divorced Choke)		

**APAGALLAMAS FLAME ARRESTORS PARAFIAMMA ARRÊTEURS DE FLAMMES**

REF	OEM	A	B	C	
REC861259	861259	6.04	3.94	9.40	
REC805016A1	805016A1	6.20	4.00	7.80	4 Et 6 Cyl.
REC85785A2	85785A2	5.71	3.73	12.83	V8
REC85784A1	85784A1	5.48	2.76	7.93	4 Et 6 Cyl.
REC805298A1	85785T	5.71	3.73	12.83	V8
	85785-2 805298A1				



REC861259

REC85785A2

REC805298A1





REC85784A1

REC805016A1

6.50

TURBO                      TURBO                      TURBINE                      TURBO

TURBO                      TURBO                      TURBINE                      TURBO

REF	OEM				
REC8M0098619	8M0098619 889341	CMD CMDQ 4.2 D4.2L / 300 D-TRONIC	REC27-8M0094247	RM21325765	<i>new</i>

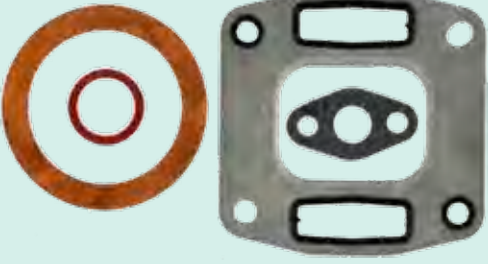

KIT JUNTAS PARA TURBO      TURBO GASKET KIT      KIT GUARNIZIONE PER TURBINE      KIT JOINTS POUR TURBO

REF	OEM	TURBO	
REC27-8M0094247	24-8M0094247 27-898101475 27-801333454 27-854129	REC8M0098619	<i>new</i>

ABRAZADERA ESCAPE TURBO      TURBO, EXHAUST CLAMP      FASCETTA SCARICO TURBO      COLLIER ECHAPPEMENT TURBO

REF	OEM		
RM21325765	864148A01 54-896332164 801763272 801331174 864148	D/CMD/QSD 1.7 / 2.0 / 3.0 / 3.6 / 2.8 / 4.2 D183, 219, 254, 530, 636 7.3L	<i>new</i>

RETÉN ACEITE DE TURBO      TURBO, SEAL      PARAOLIO TURBO      JOINT SPI DE TURBO

REF	OEM		
REC25-811461	811461	2.8 / 4.2 D254	<i>new</i>

# SISTEMA ELÉCTRICO ELECTRIC SYSTEM

# SISTEMA ELETTRICO SYSTÈME ÉLECTRIQUE

## SENSORES

## SENSORS

## SENSORE

## CAPTEURS

### SENSOR TPS

### TPS SENDER



### SENSORE TPS



### CAPTEUR TPS

REF	OEM	
REC8M0125617	8M0125617	3.0L MPI MCM/MIE V-6 & 305, 350, 454, 502 EFI
	881070T	
	805226A1	



**new**

REF	OEM		
REC853678T	853678T	MCM/MIE 4.3L, 5.0L, MX 6.2L w/ECM555, 350 Mag MPI, BIK Scorpion Ski, 7.4L MPI (L29), MCM 496 Mag & HO, 8.1S & HO	
	853678		



REF	OEM		
REC803148	803148	MCM/MIE 350 Mag, BIK Scorpion Ski (0L005900 & +)	

### SENSOR MAP



### MAP SENSOR



### SENSORE MAP

### CAPTEUR MAP

REF	OEM		
REC8M0054726	881731 8M0054726	V6 & V8 MPI (555 ECM)	

REF	OEM		
REC854445	854445	MCM 525 EFI	

REF	OEM		
REC3850396	864856A1 805217A1	MCM/MIE GM V-6 & 350, 377, MX 6.2L MPI, 7.4L MPI, 454, 502 EFI	

REF	OEM		
REC861249A1	861249A1 861249	MCM/MIE GM V-6 & 305, 350, MX 6.2L MPI, 7.4L MPI (1998+) 5.0L, 5.7L EFI (1998)	

REF	OEM		
REC879150150	879150150 849934	MCM 575SCI	

### SENSOR MAT/MAP

### MAT/MAP SENSOR

### SENSORE MAT/MAP





### CAPTEUR MAT/MAP

REF	OEM	
REC8M0087834	885165 8M0087834	350MAG MPI
		377MAG MPI
		383MAG STROKER
		4.3L MPI
		5.0L MPI
		6.2L MPI







SENSOR PICK UP		PICK UP SENSOR	SENSORE PICK UP	CAPTEUR PICK UP
REF	OEM			
REC3854001	811639 811639T	V4 / V6 / V8 Delco Voyager		

SENSOR DE OXÍGENO		OXYGEN SENSOR	SENSORE OSSIGENO	SONDE À OXYGENE
REF	OEM			
REC8M2003959	8M2003959	3.0 MPI, 4.3 MPI, 4.5 MPI, 6.2 MPI, 5.0L MPI, 5.7L MPI 8.2/377		
REF	OEM			
REC8M0142695	8M0142695 8M0095468	4.5 MPI, 6.2 MPI		

VÁLVULA DE AIRE, IAC		AIR VALVE, IDLE	VALVOLA ARIA	SOUPAPE D'AIRE
REF	OEM			
REC862998	862998	3.0L MPI, 4.3 MPI, 5.0L MPI, 350 MAG MPI, MX6.2 MPI, 8.1L 600, 662, 700 (Race sterndrive)		

SENSOR IAC		IAC SENDER	SENSORE IAC	SONDE IAC
REF	OEM			
REC3855194	805224A1	MCM/MIE GM V-6 & 305, 350, 454, 502 EFI 500, 575 (Race sterndrive)		
REF	OEM			
REC3843751	803149	MCM/MIE 350 Mag MPI Black Scorpion Ski, 377 Scorpion, MCM & Ski MX 6.2L MPI, 7.4L MPI (L29), 575SCi		

SENSOR PICADO		KNOCK SENDER	SENSORE DI CADUTA	CAPTEUR DE CLIQUETIS
REF	OEM			
REC8M0077616	805544T 8M0077616	454, 502, 540, 572 7.4L, 454 MAGNUM 8.2L 500, 525, 575, 600, 800 (Race sterndrive)		
REF	OEM			
REC806612T	806612T	MCM/MIE 305, 350, 377 GM V8 CID		

SENSOR PICK UP		PICK UP SENSOR	SENSORE PICK UP	CAPTEUR PICK UP
REF	OEM			
REC8M6003194	8M6003194 878187	V6 & V8		

**SENSOR POSICIÓN ÁRBOL DE LEVAS CAMSHAFT SENSOR**

**SENSORE POSIZIONE ASSE A CAMME**

**SONDE POSITION ARBRE À CAMMES**

REF	OEM	
REC3863130	898141	3.0, 4.3, 5.0, 5.7, 6.2L



Se instala en distribuidor  
Is installed in distributor  
Viene installato nello spinterogeno  
Installé dans le distributeur

**SENSOR POSICIÓN CIGÜENAL CRANKSHAFT SENSOR**

**SENSORE POSIZIONE ALBERO MOTORE**

**SONDE POSITION VILEBREQUIN**

REF	OEM	
REC892617	892617	8.1L 496 Mag, H.O. BRAVO

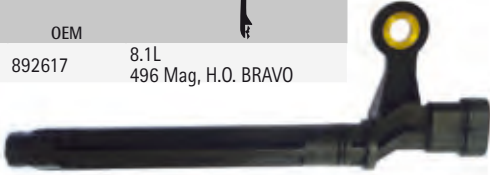

REF	OEM	
REC892615002	892615002 892615001 892615	MCM 496 Mag, 8.1 Inboard



REF	OEM	
REC864297T01	864297T01 864297 864297001	350 Magnum, 377 Magnum MPI, 5.0L MPI, 5.7L MPI, 6.2L MPI, 8.2L MPI 4.3L CARB / MPI 525, 600, 662, 700 (Race sterndrive)



REF	OEM	
REC8M0082988	8M0082988 8M0030022 8283582 828358	3.0L MPI



new

REF	OEM	
REC21124849	879194363	4.3 MPI 4.5MPI Et 6.2MPI



new

Cigüenial con tapa de AL  
Crankshaft cup in AL  
Albero motore con coperchio AL  
Vilebrequin avec couvercle en AL

**KIT SENSOR TRIM**

**TRIM SENSOR KIT**

**KIT SENSORI TRIM**

**KIT SONDE DE TRIM**

REF	OEM	
REC805320A03	805320A03	MC-1, MR, ALPHA ONE, GEN II Et BRAVO



new

**KIT SENSOR DIGITAL TRIM DIGITAL TRIM SENDER**

**SENSORE TRIM DIGITAL**

**SONDE DE TRIM DIGITAL**

REF	OEM	
REC8M0095310	8M0095310	ALPHA ONE GEN II (1998+) BRAVO I,II, III (2A417474+)



new

**KIT TEMPERATURA Y PRESIÓN DE ACEITE CON ALARMA**

**COMPLETE TEMPERATURE & OIL PRESSURE WARNING KIT**

**KIT TEMPERATURA E PRESSIONE DELL'OLIO CON ALLARME**

**KIT SONDE TEMPERATURE ET PRESSION D'HUILE AVEC ALARME**

REF	OEM
REC41400	



**SENSOR PRESIÓN DE ACEITE**



**OIL PRESSURE SENDER**



**SENSORE PRESSIONE OLIO**

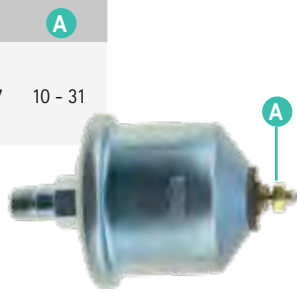

**SONDE PRESSION D'HUILE**

REF	OEM		<b>A</b>
REC8M0068784	87-815425T	1/8 - 27	10 - 31
	8M0068784		
	90806		
	815425 34623		



REF	OEM	
REC87-805605A1	3.0L (1990-95)	
	4.3L (1993-98)	
	5.0L (1988-01)	
	5.7L (1988-01)	
	7.4L (1991-00)	

REF	OEM		PSI
REC881879T11	881879T11		0-100
	881879A6		
	859210		
	859210T		
	859604A1		
	881879011		

REF	OEM		PSI
REC8M6000634	8M6000634		0-100
	897447002		
	889659002		
	4.5L MPI 6.2L MPI		

**SENSOR PRESIÓN ACEITE RAIL**

**OIL PRESSURE SENDER RAIL**

**SENSORE PRESSIONE OLIO RAIL**

**SONDE PRESSION D'HUILE RAIL**



REF	OEM		PSI
REC3843100	879172105		0-100

**SENSOR ACEITE PARA BOMBA COMBUSTIBLE**



**ELECTRIC FUEL PUMP SWITCH SENSOR**

**SENSORE OLIO PER POMPA COMBUSTIBILE**

**SONDE D'HUILE POUR POMPE CARBURANT**

REF	OEM	
REC87-864252	87-864252	

4.3, 5.0, 5.7  
Motores modernos  
Later engines  
Motori moderni  
Moteurs modernes

REF	OEM	
REC87-864252A01	87-864252A01	

4.3, 5.0, 5.7  
Motores antiguos  
Old engines  
Motori vecchio  
Moteurs anciens

**SENSOR DE TEMPERATURA AIRE**

**AIR TEMPERATURE SENSOR**

**SENSORE TEMPERATURA ARIA**

**SONDE TEMPERATURE DE L'AIRE**

REF	OEM	
REC805223T	805223T 805223	V6 Et V8 (350, 454, 496 Et 502 CID) EFI / MPI 500, 520, 525, 540, 575 (Race sterndrive)

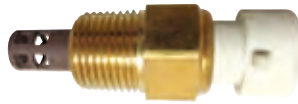

**SENSOR TEMPERATURA ENFRIADOR**

**COOLANT TEMPERATURE SENDER**

**SENSORE TEMPERATURA SCAMBIATORE**

**SONDE TEMPERATURE DE REFROIDISSEUR**

REF	OEM	
REC3850397	805218T 805218	350 MAG ,PI 383 MAG 4.3L MPI, 5.0L MPI, 3.0L MPI 6.2L MPI 357, 377 4.3 CARB, EFI 454, 496 MAG, EFI 5.7L CARB, EFI 8.1, 8.2L MIE



**SENSOR CAUDAL DEL AGUA**

**WATER SENSOR**

**SENSORE ACQUA**

**SONDE DE L'EAU**

REF	OEM		PSI
REC8M6000623	8M6000623 881879010 8818793	V6 Et V8 4.5L MPI	50



**SENSOR TEMPERATURA AGUA**

**WATER TEMPERATURE SENDER**

**SENSORE TEMPERATURA ACQUA**

**SONDE TEMPERATURE DE L'EAU**

REF	OEM	
REC97258A1	97258A1 97258 34625 F16900198 F16900152	1/2" - 14 NPT



REF	OEM	
REC806490T	806490T 97257A1 97-257 806490 811091 36525	3/8" - 18 NPT



REF	OEM
REC48952	48952





REF	OEM	
REC15995	15995	MCM 3.71

PARA RELOJES  
FOR GAUGES  
PER GLI OROLOGI  
POUR LES GAUGES





**new**

REF	OEM	
REC8M0148668	8M0148668 885342002 885342001	6.2L MPI, 4.3L, 4.5L MPI, 3.0L MPI 8.1L, 8.2L MPI 496 MAG, 525 EFI



**new**

REF	OEM	
REC8M0142542	8M0142542	TRANSMISION: ZF63, 63A 3.0L VM V6 AXIUS SYSTEM



**new**



GUÍA DE SENSORES			SENSOR APPLICATION			GUIDA SENSORI		GUIDE DES SONDÉS				
MOD.	CYL		SERIE SERIAL SERIE SERIE	INYECTOR INJECTOR INNIETORE INJECTEUR	KIT	IAC	TPS	REGULADOR PRESIÓN REGULATOR PRESSURE REGOLATORE PRESSIONE REGULATEUR		MAP	PICADO KNOCK BATTITO CLIQUETIS	TEMP. AIRE AIR TEMP. TEMP. ARIA TEMP. AIRE
								RAIL	COOLER			
262 MAG EFI	262/V6	1996-97	OF803800-OK999999		REC3858941	REC3855194	REC8M0125617		REC807952A1	REC3850396		
4.3L EFI	262/V6	1998-01	OL012009-OM299999		REC3858941	REC3855194	REC8M0125617		REC807952A1	REC861249A1		REC805223T
4.3L MPI	262/V6	2002-07	OM300000+	REC885176	REC9-33301	REC862998	REC853678T	REC885174	REC807952A1			REC3850397
5.0L EFI	305/V8	1998-01	OL012052-OM299999		REC853998A1	REC3855194	REC8M0125617		REC807952A1	REC861249A1		REC805223T
5.0L MPI	305/V8	2002-07	OM300000+	REC885176	REC9-33301	REC862998	REC853678T	REC885174	REC861126A1			
5.0L MPI DTS	305/V8	2005-07	OW310000+	REC885176	REC9-33301			REC885174				
320 EFI	350/V8	1987-89	OA543604-OC622418			REC862998						
350 MAG ALPHA EFI (GEN+)	350/V8	1996-97	OF800300-OK999999		REC853998A1	REC3855194	REC8M0125617		REC807952A1	REC3850396	REC806612T	
350 MAG BRAVO MPI	350/V8	1995-96	OF415189-OK001500			REC3855194	REC8M0125617			REC3850396	REC806612T	
350 MAG BRAVO MPI (GEN+)	350/V8	1997	OK001501-OK999999		REC9-33303	REC3855194	REC8M0125617		REC807952A1	REC3850396	REC806612T	
	350/V8	1994-96	OF215561-OF820706		REC853998A1	REC3855194	REC8M0125617			REC3850396	REC806612T	
350 MAG EFI SKI	350/V8	1996	OF820707-OK040005		REC853998A1	REC3855194	REC8M0125617		REC807952A1	REC3850396	REC806612T	
	350/V8	1997	OK040006-OK999999		REC853998A1	REC3855194	REC8M0125617		REC807952A1	REC3850396	REC806612T	
	350/V8	1998	OL010019-OL331598		REC9-33302	REC3843751	REC853678T		REC807952A1	REC861249A1	REC806612T	
	350/V8	1998	OL336000-OL346999		REC9-33302	REC3843751	REC853678T		REC807952A1	REC861249A1	REC806612T	
350 MAG MPI	350/V8	1999	OL331599-OL-335999		REC9-33302	REC3843751	REC803148		REC807952A1	REC861249A1	REC806612T	REC805223T
	350/V8	1999-01	OL340000-OM299999		REC9-33302	REC3843751	REC803148		REC807952A1	REC861249A1	REC806612T	REC805223T
	350/V8	2002-07	OM300000+	REC885176	REC9-33301	REC862998	REC853678T	REC885174	REC861126A1			
350 MAG MPI DTS	350/V8	2005-07	OW310000+	REC885176	REC9-33301			REC885174				
350 MAG MPI HORIZON	350/V8	2002-07	OM300000+	REC885176	REC9-33301	REC862998	REC853678T	REC885174	REC861126A1			
350 MAG MPI HORIZON DTS	350/V8	2005-07	OW310000+	REC885176	REC9-33301			REC885174				
	350/V8	1999-01	OL304700-OM299999		REC9-33302	REC3843751	REC803148		REC807952A1	REC861249A1	REC806612T	
350 MAG MPI HORIZON MIE	350/V8	2002-04	OM300000-OM398371	REC885176	REC9-33301	REC862998	REC853678T		REC861126A1			
	350/V8	2004-07	OM398372+	REC885176	REC9-33301	REC862998	REC853678T	REC885174				
350 MAG MPI HORIZON MIE DTS	350/V8	2005-07	OW310000+	REC885176	REC9-33301			REC885174				
	350/V8	1998	OL002008-OL304999		REC9-33302	REC3843751	REC853678T		REC807952A1	REC861249A1	REC806612T	
350 MAG MPI MIE	350/V8	2002-04	OM300000-OM398371	REC885176	REC9-33301	REC862998	REC853678T	REC885174	REC861126A1			
	350/V8	2004-07	OM398372+	REC885176	REC9-33301	REC862998	REC853678T	REC885174				
350 MAG MPI MIE DTS	350/V8	2005-07	OW310000+	REC885176	REC9-33301			REC885174				
350 MAG EFI SKI	350/V8	1994-96	OF215561-OF820706		REC853998A1	REC3855194	REC8M0125617			REC3850396	REC806612T	
	350/V8	1998	OL002600-OL304599		REC9-33302	REC3843751	REC853678T		REC807952A1	REC861249A1	REC806612T	
350 MAG MPI SKI	350/V8	1999-01	OL304600-OM299999		REC9-33302	REC3843751	REC803148		REC807952A1	REC861249A1	REC806612T	
	350/V8	2002-07	OM300000+	REC885176	REC9-33301	REC862998	REC853678T	REC885174	REC861126A1			
5.7L EFI	350/V8	1995-97	OF225560-OK999999		REC853998A1	REC3855194	REC8M0125617		REC807952A1	REC3850396	REC806612T	
	350/V8	1998-01	OL010035-OM299999		REC853998A1	REC3855194	REC8M0125617		REC807952A1	REC861249A1	REC806612T	REC805223T
5.7L EFI (GEN+)	350/V8	1997	OK040300-OK999999		REC853998A1	REC3855194	REC8M0125617		REC807952A1	REC3850396	REC806612T	
5.7LX BRAVO EFI (GEN+)	350/V8	1996-97	OF800300-OK999999		REC853998A1	REC3855194	REC8M0125617		REC807952A1	REC3850396	REC806612T	
5.7LX EFI	350/V8	1995-97	OF225560-OK999999		REC853998A1	REC3855194	REC8M0125617		REC807952A1	REC3850396	REC806612T	
	350/V8	1996	OF350583-OK040000			REC3843751	REC853678T	REC885174		REC3850396	REC806612T	
	350/V8	1997	OK040001-OL002699		REC9-33303	REC3843751	REC853678T		REC807952A1	REC3850396	REC806612T	
BLACK SCORPION SKI	350/V8	1998	OL002700-OL005600		REC9-33303	REC3843751	REC853678T		REC807952A1		REC806612T	
	350/V8	1998-05	OL005601-OM391599		REC9-33303	REC3843751	REC803148		REC807952A1		REC806612T	
	350/V8	2003-07	OM391600+		REC9-33303	REC862998	REC803148		REC807952A1			
377 SCORPION MCM	377/V8	1999-05	OL416146-OM907201		REC9-33303	REC3843751	REC803148		REC807952A1	REC3850396	REC806612T	
377 SCORPION SKI	377/V8	1997-98	OK000656-OL600314		REC9-33303	REC3843751	REC853678T		REC807952A1	REC3850396	REC806612T	
	377/V8	2000-01	OL68003-OM299999		REC9-33302	REC3843751	REC803148		REC807952A1	REC861249A1	REC806612T	REC805223T
MX 6.2L MPI	377/V8	2002-04	OM300000-OW059999	REC885176	REC9-33301	REC862998	REC853678T	REC885174	REC861126A1			
	377/V8	2004-07	OW060000+	REC885176	REC9-33301	REC862998	REC853678T	REC885174				
MX 6.2L MPI DTS	377/V8	2005-07	OW310000+	REC885176	REC9-33301			REC885174				
MX 6.2L MPI HORIZON	377/V8	2002-04	OM300000-OW059999	REC885176	REC9-33301	REC862998	REC853678T	REC885174	REC861126A1			
	377/V8	2004-07	OW060000+	REC885176	REC9-33301	REC862998	REC853678T	REC885174				

MOD.	CYL		SERIE SERIAL SERIE SERIE	INYECTOR INJECTOR INNIETTORE INJECTEUR	KIT	IAC	TPS	REGULADOR PRESIÓN REGULATOR PRESSURE REGOLATORE PRESSIONE REGULATEUR		MAP	PICADO KNOCK BATTITO CLIQUETIS	TEMP. AIRE AIR TEMP. TEMP. ARIA TEMP. AIRE
								RAIL	COOLER			
MX 6.2L MPI HORIZON DTS	377/V8	2005-07	OW310000+	REC885176	REC9-33301	REC862998		REC885174				
MX 6.2L MPI HORIZON MIE	377/V8	2002-04	OM300000- OM398394	REC885176	REC9-33301	REC862998	REC853678T	REC885174	REC861126A1			
	377/V8	2004-07	OM398395+	REC885176	REC9-33301	REC862998	REC853678T	REC885174				
MX 6.2L MPI HORIZON MIE DTS	377/V8	2005-07	OW390000+	REC885176	REC9-33301			REC885174				
MX 6.2L MPI MIE	377/V8	2002-04	OM300000- OM398394	REC885176	REC9-33301	REC862998	REC853678T	REC885174	REC861126A1			
	377/V8	2004-07	OM398395+	REC885176	REC9-33301	REC862998	REC853678T	REC885174				
MX 6.2L MPI MIE DTS	377/V8	2005-07	OW390000+	REC885176	REC9-33301	REC862998		REC885174				
MX 6.2L MPI SKI	377/V8	2002-07	OM317000+	REC885176	REC9-33301	REC862998	REC853678T	REC885174	REC861126A1			
	377/V8	2001-03	OL005601- OM391599		REC9-33303	REC384375I	REC803148		REC807952A1		REC806612T	
MX 6.2L BLACK SCORPION SKI	377/V8	2003-07	OK391750+		REC9-33303	REC862998	REC803148		REC807952A1			
454 MAG EFI	454/V8	1994-96	OF115700- OF802349		REC9-33303	REC3855194	REC8M0125617	REC805227A1		REC3850396	REC8M0077616	REC805223T
454 MAG EFI SKI	454/V8	1994-96	OF215800- OF820099		REC9-33303	REC3855194	REC8M0125617	REC805227A1		REC3850396	REC8M0077616	REC805223T
	454/V8	1996-97	OF820099- OK999999		REC9-33303	REC3855194	REC8M0125617	REC805227A1		REC3850396	REC8M0077616	REC805223T
454 MAG MPI	454/V8	1996-97	OF802350- OK147349		REC9-33303	REC3855194	REC8M0125617	REC805227A1	REC3850396	REC8M0077616	REC805223T	REC805223T
	454/V8	1996-97	OK147350- OL085399		REC9-33303	REC3855194	REC8M0125617	REC805227A1	REC860349A1	REC3850396	REC8M0077616	REC805223T
454 MAG MPI HORIZON MIE	454/V8	1999-01	OL085400- OM024999		REC9-33302	REC3855194	REC8M0125617		REC861126A1	REC3850396	REC8M0077616	REC805223T
	454/V8	1998	OL002200- OL086049		REC9-33303	REC3855194	REC8M0125617	REC805227A1	REC860349A1	REC3850396	REC8M0077616	REC805223T
74.L MPI (L29)	454/V8	1999-01	OL010003- OM024330	REC802632T	REC9-33304	REC384375I	REC853678T	REC802630T01	REC861126A1	REC861249A1	REC8M0077616	REC805223T
	454/V8	1998-01	OF503052- OK147349		REC9-33303	REC3855194	REC8M0125617	REC805227A1		REC3850396	REC8M0077616	REC805223T
7.4L MPI MIE	454/V8	1995-96	OK147350- OK999999		REC9-33303	REC3855194	REC8M0125617	REC805227A1	REC860349A1	REC3850396	REC8M0077616	REC805223T
	454/V8	1997	OL010003- OL674613	REC802632T	REC9-33304	REC384375I	REC8M0125617	REC802630T01	REC861126A1	REC861249A1	REC8M0077616	REC805223T
7.4LX TBI	454/V8	1998-01	OF820000- OK999999			REC3855194	REC8M0125617		REC807952A1	REC3850396	REC8M0077616	REC805223T
	454/V8	1996-97	OF602010- OK147349		REC9-33303	REC3855194	REC8M0125617	REC805227A1		REC3850396	REC8M0077616	REC805223T
7.4LX MPI	454/V8	1996	OK147350- OK999999		REC9-33303	REC3855194	REC8M0125617	REC805227A1	REC860349A1	REC3850396	REC8M0077616	REC805223T
	496/V8	1997	OM025000- OW059999	REC881693002		REC862998	REC853678T	REC802630T01	REC861126A1			
496 MAG	496/V8	2001-04	OW060000+	REC881693002		REC862998	REC853678T	N.S.S.	REC892681	REC8M0054726		
	496/V8	2004-07	OM025000- OW059999	REC881693002				REC802630T01	REC861126A1			
496 MAG DTS	496/V8	2001-04	OW060000+	REC881693002				N.S.S.		REC8M0054726		
	496/V8	2004-07	OM025000- OW059999	REC881693002		REC862998	REC853678T	REC802630T01	REC861126A1			REC805223T
496 MAG HO	496/V8	2001-04	OW060000+	REC881693002		REC862998	REC853678T	N.S.S.		REC8M0054726		REC805223T
	496/V8	2004-07	OM025000- OW059999	REC881693002				REC802630T01	REC861126A1			REC805223T
496 MAG HO DTS	496/V8	2001-04	OW060000+	REC881693002				N.S.S.		REC8M0054726		REC805223T
	496/V8	2004-07	OM026000- OW059999	REC881693002		REC862998	REC853678T	REC802630T01	REC861126A1			REC805223T
8.1L MIE	496/V8	2001-04	OW090000+	REC881693002		REC862998	REC853678T	N.S.S.	REC892681	REC8M0054726		REC805223T
	496/V8	2004-07	OM026000- OW089999	REC881693002		REC862998	REC853678T	REC802630T01	REC861126A1			REC805223T
8.1L HO MIE	496/V8	2001-04	OW090000+	REC881693002		REC862998	REC853678T	N.S.S.	REC892681	REC8M0054726		REC805223T
	500/V8	2004-07	OL001477+		REC9-33304	REC3855194		REC849899	REC861126A1	REC3850396	REC8M0077616	
502 MAG MPI	502/V8	1999-05	OD840650- OK147349		REC9-33303	REC3855194	REC8M0125617	REC805227A1		REC3850396	REC8M0077616	
	502/V8	1993-96	OK147350- OL085432		REC9-33303	REC3855194	REC8M0125617	REC805227A1	REC860349A1	REC3850396	REC8M0077616	REC805223T
525 EFI	502/V8	1997-98	OL085432- OM024999		REC9-33302	REC3855194	REC8M0125617		REC861126A1	REC3850396	REC8M0077616	REC805223T
	502/V8	1999-01	OM900146+		REC9-33303		REC8M0125617		REC861126A1	REC854445		
575 SCI	502/V8	2003-07	OL306696- OM950526			REC3855194	REC8M0125617		REC807952A1	REC879150150	REC8M0077616	REC805223T
	502/V8	00-05	OF819620- OK147349		REC9-33303	REC3855194	REC8M0125617	REC805227A1		REC3850396	REC8M0077616	
8.2 MPI MIE	502/V8	1996	OK127350- OL086012		REC9-33303	REC3855194	REC8M0125617	REC805227A1	REC860349A1	REC3850396	REC8M0077616	
	502/V8	97-98	OL086013- OL674200		REC9-33303	REC3855194	REC8M0125617		REC861126A1	REC3850396	REC8M0077616	

# MOTORES DE ARRANQUE



# STARTERS

# MOTORINI AVVIAMENTO DEMARREUR

REF	OEM				
REC50-8M0095471	50-8M0095471	12V	11 CW	14"	4.5L MPI 2A441953+ 6.2L MPI 2A456613+

REF	OEM
REC10-861788	10-861788



new

Motor de arranque para substituir a todos los motores de tamaño pequeño con tornillos fijación en diagonal excepto los 7.4L

Starter to replace all the little engines with diagonally fixation screws excepting 7.4L

Motorino d'avviamento per sostituire tutti i motori V 6 e V 8 con motorini con viti di supporto trasversali eccetto i motori 7.4L

Démarrreur pour remplacer tous les moteurs de petite taille avec des vis de fixation diagonales sauf 7.4L

REF	OEM				
REC50-863007A1	50-863007A1	12V 1.4 kW	11	14"	REC3859054 4 cyl V6 Et V8 3.0L

REF	OEM
REC10-861788	10-861788



Motor de arranque Heavy Duty. Tornillos de fijación en diagonal.

Starter with diagonally fixation screws.



Motorino d'avviamento Heavy Duty con viti di supporto trasversali.

Démarrreur à usage intensif. Vis de fixation diagonale.

REF	OEM				
REC3885317	50-864340A2	12V 1.7 kW	11	14"	RECPG260 V6 Et V8 7.4L

REF	OEM
REC10-861788	10-861788

REF	OEM				
REC3854190	50-69865A1 50-12782 50-56886	12V	10	REC0987883	FORD 5.0 Et 5.8L



Tornillos de fijación en diagonal.

Starter with diagonally fixation screws.

Viti di supporto trasversali.

Vis de fixation diagonale.

REF	OEM				
REC50-99418A2	50-864340A2 50-99418A2	12V	9	14 <sup>1/4"</sup>	REC3853869 V6 Et V8

REF	OEM
REC10-861788	10-861788



Contrarrotación o montaje en campana. Starter counter clockwise.

Controrotante, posizionato nella campana.

Contre-rotation ou montage sur capot.

REF	OEM			
REC50-808011A05	50-808011A05 50-88671A1 50-80811A4	12V 1.4 kW	9	4, 6 Et 8 cyl 5.7 MIE / 6.2 MIE.



Motor de arranque pequeño 4 en línea.

Starter Clockwise for 4L.

Viti di supporto trasversali

Petit moteur de démarrage 4 en ligne.

REF	OEM					
REC50-806965A4	50-863007A1 50-806963A2 50-806965A4	12V 1.4 kW	11	12 <sup>3/4"</sup>	REC3859054	V6 & V8

	OEM
MP0180-001	10-812509184
REC10-861788	10-861788



REF	OEM					
REC50-8M0090697	50-812429A2 50-806965A2 50-806965A4 50-8M0090697	12V 1.4 kW	11	12 <sup>3/4"</sup>	REC3859054	3.0L

	OEM
MP0180-001	10-812509184
REC10-861788	10-861788



Modelo antiguo. Motor de arranque 4 en línea. Tornillos sujeción misma altura

Old style. Starter heavy duty standard rotation 4 in line. In line mounting holes.

Modello vecchio. Motorino d'avviamento 4 in linea. (Viti di supporto parallele)

Modèle plus ancien. Démarreur 4 en ligne. Vis de fixation de même hauteur.

REF	OEM					
	50-806965A4 50-99417A2	12V	9	REC3853869		V6 & V8

	OEM
MP0180-001	10-812509184
REC10-861788	10-861788



REF	OEM					
REC3916854	50-805991	12V	10			7.3L BRAVO & MIE DIESEL NAV444 V8 (1994-96) 6.9L



Motor de arranque 4 en línea modelo 470.

Starter clockwise 4 in line 470 mod. and engines with transmission.

Motorino d'avviamento 4 in linea modello 470.

Moteur de démarrage 4 en ligne modèle 470.

REF	OEM					
REC50-97499A2	50-72550A2 50-47454 50-65785A1 50-79604A3	12V 1.4 kW	9			4, 6 & 8 cyl



**PMGR** new

REF	OEM					
REC879194371	879194371 882481	12V 1.4 kW	13 CW			CMD 1.7 MI/MS D1.7L DTI

**PMGR** new

REF	OEM					
REC879172259	879172259 896332191	12V 2.3 kW	9 CW			CMD2.8 CMD QSD 2.8 & 4.2



## ALTERNADORES Y REGULADORES

## ALTERNATORS & VOLTAGE REGULATORS

## ALTERNATORI E REGOLATORI



## ALTERNATEURS ET REGULATEURS

### ALTERNADORES

### ALTERNATORS



### ALTERNATORI

### ALTERNATEURS



REF	OEM		 6	
REC898101505	898101505	12V 110A	SERPENTÍN GROOVE PULLEY SERPENTINA SERPENTINE	CMD QSD 2.0/2.8 & 4.2 2.0L EI



new

REF	OEM			REG.	
REC69729	78403A2 59755 69729 56045	12V 61A	SIMPLE SINGLE SINGOLA SIMPLE	AUTOEXCITANTE SELF-EXCITING AUTOECCITANTE AUTO-EXCITANT	CMD QSD 2.0/2.8 & 4.2 2.0L EI





REF	OEM			REG.	
REC78403A2	817119A4 78402 78403A1 78403A32 92497A3	12V 63A	SIMPLE SINGLE SINGOLA SIMPLE	AUTOEXCITANTE SELF-EXCITING AUTOECCITANTE AUTO-EXCITANT	3.0/V6 & V8





REF	OEM		 6 (65 mm)	REG.	
REC862031T1	862031T1 862031 862031T	12V 70A	SERPENTÍN GROOVE PULLEY SERPENTINA SERPENTINE	INTERNO INTERNAL INTERNO INTERNE	4.3 & 5.7L (1997+)



REF	OEM			REG.	
REC3860769	817119A4 98555 12449 19685 817119 817119A1	12V 55A	SIMPLE SINGLE SINGOLA SIMPLE	INTERNO INTERNAL INTERNO INTERNE	4.3 & 5.7L (1998+)



REF	OEM			REG.	
REC805884T	805884T 805884 805447T	12V 65A	SIMPLE SINGLE SINGOLA SIMPLE	INTERNO INTERNAL INTERNO INTERNE	EFI & diesel



REF	OEM	⚡	☪	REG.	🔧
REC862030T01	862030T01 862030T	12V 70A	SIMPLE SINGLE SINGOLA SIMPLE	INTERNO INTERNAL INTERNO INTERNE	3.0L (1999+)



REF	OEM	⚡	☪ 6	REG.	🔧
REC807653T	807653T 807653	12V 65A	SERPENTÍN GROOVE PULLEY SERPENTINA SERPENTINE	INTERNO INTERNAL INTERNO INTERNE	V6 Et V8 (MANDO)



REF	OEM	⚡	☪ 6	REG.	🔧
REC807652T	807652T 807652	12V 55A	SERPENTÍN GROOVE PULLEY SERPENTINA SERPENTINE	INTERNO INTERNAL INTERNO INTERNE	V6 Et V8 (MANDO)



REF	OEM	⚡	☪ 6 (50 mm)	REG.	🔧
REC863077T	863077T 86307AR01	12V 70A	SERPENTÍN GROOVE PULLEY SERPENTINA SERPENTINE	INTERNO INTERNAL INTERNO INTERNE	4.3L, 6.2L Et 5.7L (1995+) 4.5 MPI 8.1 Et 4.2L



REF	OEM	⚡	☪ 6 (50 mm)	REG.	🔧
REC882571	882571 8M0084523	12V 50A	SERPENTÍN GROOVE PULLEY SERPENTINA SERPENTINE	MCM 1.7L DTI. CMD 1.7 MI 120 L/L4 CMD 1.7 MS 120L/L4	



REF	OEM	⚡	☪ 4	REG.	🔧
REC8M0064021	834832 834832T2 857006A3	12V 50A	SERPENTÍN GROOVE PULLEY SERPENTINA SERPENTINE	RACE STERNDRIVE 500EFI, 575 SCI	





**KIT SUSTITUCIÓN ALTERNADOR**

**ALTERNATOR CONVERSION KIT**

**KIT SOSTITUZIONE ALTERNATORE**

**KIT ALTERNATEUR**

REF		
REC18-5953	12V 68A	470 (3.7L) 224 (3.7L)



**REGULADOR ALTERNADOR**

**VOLTAGE REGULATOR FOR ALTERNATORS**

**REGOLATORE ALTERNATORE**

**REGULATEUR ALTERNATEUR**

REF	OEM	
REC42785	42785	MANDO



**TRIM**

**MOTOR TRIM**

**TRIM ENGINES**

**MOTORI TRIM**

**MOTEUR TRIM**

Motor Trim completo con soporte inox. Incluye motor, solenoides, fusible y cableado.

Complete bracket assembly with Tilt/Trim motor, solenoids, fuse block and wiring. Stainless steel bracket.

Motore trim completo di supporto in acciaio inox. Include il motore, solenoide, fusibile e cablaggio.

Moteur de réglage complet avec support en acier inoxydable. Comprend le moteur, les solénoïdes, le fusible et le câblage.

REF	OEM	
REC865380A25	414336A6 14336A9 88183A12	(1983+) Quick connect



Motor Trim completo con depósito.



Oilayne Complete for late -MCM.

Motore trim completo con serbatoio.

Moteur trim complet avec réservoir.

REF	OEM	
REC865380A13	865380A13 865380A25 88183A12 14336A8 14336A20	12V



REF	OEM			
REC891736T	891736T 17649 17649T	12V	3	Alpha, II gen Et Bravo



**CONVERTIDOR DE 3 A 2 CABLES**

**3 TO 2 WIRE WIRED CONVERTER**

**CONVERTITORE CAVI DA 3 A 2 FILI**

**FAISCEAU CONVERTISSEUR 3 À 2 FILS**

REF	OEM
REC84-819514T26	

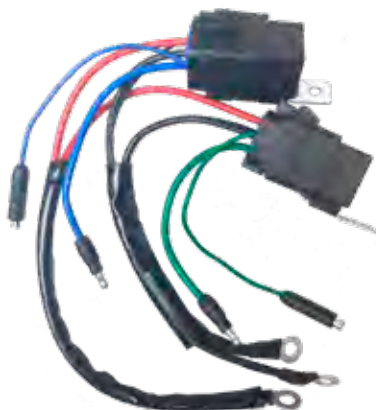

**SOPORTE CON PARTES ELECTRICAS**

**BRACKET ASSY**

**SUPPORTO TRIM**

**SUPPORT POMPE DE TRIM AVEC RELAIS**

Soporte motor Trim fabricado en acero inox. Incluye solenoides, fusible y cableado.

Bracket assembly with solenoids, fuse block and wiring. Stainless steel bracket.

Supporto motorino Trim in acciaio inox. Include i solenoidi, fusibile e cablaggio.

Le support du moteur de la garniture est en acier inoxydable. Comprend les solénoïdes, le fusible et le câblage.

REF	OEM
REC862548A1	865380A13



REF	OEM
REC42419A1	862548A1 42419A1



**VASCHETTA TRIM**

**RESERVOIR TRIM**

**DEPÓSITO TRIM**

**RESERVOIR TRIM**

REF	OEM	
REC18525A1	18525A1	1
REC883166A2	883166A2	4





**SOLENOIDES , RELÉS Y FUSIBLES**

**SOLENOID, RELAY & FUSES**

**SOLENOIDI, RELÉ E FUSIBILE**

**SOLÉNOÏDE, RELAIS ET FUSIBLES**

**SOLENOIDES**

**SOLENOID**

**SOLENOIDI**

**SOLÉNOÏDE**

REF	OEM	⚡
REC89-818999A2	89-818999A2 89-818999A1 89-805188A1	12V



**SOLENOIDE TRIM**

**TRIM SOLENOID**

**SOLENOIDI TRIM**

**SOLÉNOÏDE TRIM**

REF	OEM	⚡
REC89-96158T	89-96158T 89-96158	12V
REC852565	89-853654A1 89-68258A4	
REC89-818997A1	89-818997T1 89-818997A1	



REC852565



REC89-818997A1



REC89-96158T

**SOLENOIDE ARRANQUE**

**STARTER SOLENOID**

**SOLENOIDI AVVIAMENTO**

**SOLÉNOÏDE DE DEMARREUR**

REF	OEM	⚡
REC89-96054T	89-96054T 89-96054 89-91975	12V
REC89-96158T	89-818864T 89-818864	
REC3853839	87-76416A1	
REC378444	25661T1 25661	
REC65057T1	65057T1 65057A1	



REC89-96158T



REC3853839



REC378444



REC65057T1



REC89-96054T

**SOLENOIDE DELCO REMY**

**DELCO REMY SOLENOID**

**SOLENOIDI DELCO REMY**

**SOLÉNOÏDE DELCO REMY**

REF	OEM	⚡
REC13037	13037 8733261	9.5 cm
REC3853869	89-853654A1 89-18080	7.5 cm
REC3859054	89-99253 809463A1	12V



REC13037  
REC3853869



REC3859054

**EXTENSOR DE SOLENOIDE PARA TERMINALES**

**SOLENOID EXTENSOR FOR TERMINALS**

**PROLUNGA TERMINALE PER SOLENOIDE**









**EXTENSION POUR SOLÉNOÏDE**

REF	OEM
REC855314	







RELÉ	RELAY	RELÉ	RELAIS						
<table border="1"> <thead> <tr> <th>REF</th> <th>OEM</th> <th></th> </tr> </thead> <tbody> <tr> <td>REC876037</td> <td>8M0057697 8M0032176</td> <td>4.5L Et 6.2L MPI 40/30 A</td> </tr> </tbody> </table>	REF	OEM		REC876037	8M0057697 8M0032176	4.5L Et 6.2L MPI 40/30 A			
REF	OEM								
REC876037	8M0057697 8M0032176	4.5L Et 6.2L MPI 40/30 A							

RELÉ ARRANQUE Y BOMBA GASOLINA	RELAY FOR IGNITION & FUEL PUMP	RELÉ DI AVVIAMENTO, E POMPA BENZINA	RELAIS DE DEMARREUR ET POMPE D'ESSENCE				
<table border="1"> <thead> <tr> <th>REF</th> <th>OEM</th> </tr> </thead> <tbody> <tr> <td>REC86-865202T</td> <td>86-865202T</td> </tr> </tbody> </table>	REF	OEM	REC86-865202T	86-865202T			
REF	OEM						
REC86-865202T	86-865202T						

RELÉ PARA ACELERADOR Y EJE	RELAY FOR THROTTLE AND SHIFT	RELÉ DI ACCELERATORE E ASSE	RELAIS POUR L'ACCELERATION ET L'ARBRE												
<table border="1"> <thead> <tr> <th>REF</th> <th>OEM</th> <th></th> </tr> </thead> <tbody> <tr> <td>REC882751A04</td> <td>882751A04</td> <td>496 MAG (BASE Et H.O.) 8.1L INBOARD (BASE Et H.O.) 8.1L TOWSPORT</td> </tr> </tbody> </table> <p>Relay para cable mecánico Relay for mechanical wire Relé per cavo meccanico Relais de câble mécanique</p>	REF	OEM		REC882751A04	882751A04	496 MAG (BASE Et H.O.) 8.1L INBOARD (BASE Et H.O.) 8.1L TOWSPORT		<table border="1"> <thead> <tr> <th>REF</th> <th>OEM</th> <th></th> </tr> </thead> <tbody> <tr> <td>REC3854138</td> <td>882751A1 828151 828151A1 882751A2 882751</td> <td>8.2L INBOARD (BASE Et H.O.) EC 8.2L MAG V6 Et V8</td> </tr> </tbody> </table> <p>Relay para cable digital y mecánico Relay for digital &amp; mechanical cable Relé per cavo digitale e meccanico Relais pour câble digital et mécanique</p>	REF	OEM		REC3854138	882751A1 828151 828151A1 882751A2 882751	8.2L INBOARD (BASE Et H.O.) EC 8.2L MAG V6 Et V8	
REF	OEM														
REC882751A04	882751A04	496 MAG (BASE Et H.O.) 8.1L INBOARD (BASE Et H.O.) 8.1L TOWSPORT													
REF	OEM														
REC3854138	882751A1 828151 828151A1 882751A2 882751	8.2L INBOARD (BASE Et H.O.) EC 8.2L MAG V6 Et V8													

RELÉ PARA ALARMA Y VARIOS	RELAY FOR ALARM & OTHERS	RELÉ PER ALARMA E ALTRI	RELAIS POUR ALARME ET D'AUTRES						
<table border="1"> <thead> <tr> <th>REF</th> <th>OEM</th> <th></th> </tr> </thead> <tbody> <tr> <td>REC882751A04</td> <td>821509 821509T01</td> <td>CMD 2.8 EI, ES (165) CMD 4.2 EI, ES, MI, MS (200, 230, 250, 300) D2.8L/165 D-TRONIC D3.0L, D3.6L, D4.2L/(200, 220, 250, 300)</td> </tr> </tbody> </table>	REF	OEM		REC882751A04	821509 821509T01	CMD 2.8 EI, ES (165) CMD 4.2 EI, ES, MI, MS (200, 230, 250, 300) D2.8L/165 D-TRONIC D3.0L, D3.6L, D4.2L/(200, 220, 250, 300)			
REF	OEM								
REC882751A04	821509 821509T01	CMD 2.8 EI, ES (165) CMD 4.2 EI, ES, MI, MS (200, 230, 250, 300) D2.8L/165 D-TRONIC D3.0L, D3.6L, D4.2L/(200, 220, 250, 300)							

FUSIBLE MOTOR	CIRCUIT BREAKER	FUSIBILE MOTORE	FUSIBLE MOTEUR												
<table border="1"> <thead> <tr> <th>REF</th> <th>OEM</th> <th></th> </tr> </thead> <tbody> <tr> <td>BS2142</td> <td>88-11178A01</td> <td>50A</td> </tr> <tr> <td>BS2143</td> <td>88-93582</td> <td>60A</td> </tr> <tr> <td>BS2138</td> <td>88-8M2011907</td> <td>15A</td> </tr> </tbody> </table>	REF	OEM		BS2142	88-11178A01	50A	BS2143	88-93582	60A	BS2138	88-8M2011907	15A			
REF	OEM														
BS2142	88-11178A01	50A													
BS2143	88-93582	60A													
BS2138	88-8M2011907	15A													

FUSIBLE MOTOR TRIM	TRIM FUSE ASSY	FUSIBILE MOTORINI TRIM	FUSIBLE MOTEUR TRIM									
<table border="1"> <thead> <tr> <th>REF</th> <th>OEM</th> <th></th> </tr> </thead> <tbody> <tr> <td>REC88-79023T10</td> <td>88-79023T10</td> <td>110A</td> </tr> <tr> <td>RM88-79023A91</td> <td>88-79023A91</td> <td>90A</td> </tr> </tbody> </table>	REF	OEM		REC88-79023T10	88-79023T10	110A	RM88-79023A91	88-79023A91	90A			
REF	OEM											
REC88-79023T10	88-79023T10	110A										
RM88-79023A91	88-79023A91	90A										

**FUSIBLE ATM**                      **ATM FUSE**                      **FUSIBLE ATM**                      **FUSIBLE ATM**

REF	OEM	⚡	📄
AM603905	88-832969T05	5 A	
AM603910	88-832969T10	10 A	
AM603915	88-832969T15	15 A	2
AM603920	88-832969T20	20 A	
AM603930	88-832969T30	30 A	



**FUSIBLE ATC**                      **ATC FUSE**                      **FUSIBLE ATC**                      **FUSIBLE ATC**

REF	OEM	⚡	📄
BS5291		3 A	
BS5299		4 A	
BS5292	862646	5 A	
BS5293		7,5 A	
BS5294	862647	10 A	2
BS5295		15 A	
BS5296	88-212619	20 A	
BS5297		25 A	
BS5298		30 A	

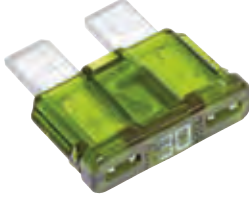

**FUSIBLE MAXI**                      **MAXI FUSE**                      **FUSIBLE MAXI**                      **FUSIBLE MAXI**

REF	OEM	⚡	📄
BS5138		30 A	
BS5139		40 A	
BS5140	88-79023A94	50 A	2
BS5141		60 A	
BS5142		70 A	
BS5143		80 A	



**FUSIBLE TERMINAL DE BATERIA**                      **BATTERY SWITCH FUSE**                      **FUSIBLE TERMINALE BATERIA**                      **FUSIBLE TERMINAL BATERIE**

REF	OEM	⚡
BS5175	88-8M0129533	30A
BS5177	88-8M0129534	50A
BS5181	88-8M0129535	80A
BS5182	88-8M0129560	90A
BS5183	88-8M0130941	100A
BS5185	88-8M0129528	150A
BS5187	88-8M0129530	200A
BS5189	88-8M0129531	250A

REF	OEM
BS5191	





**MERCATHODE**                      **MERCATHODE**                      **MERCATHODE**                      **MERCATHODE**



REF	OEM
REC42600A09	42600A09 42600A5 42600A3 42600A1



new

INTERRUPTORES TRIM	POWER TRIM SWITCH ASSY	INTERRUTTORE TRIM	COMMUTATEUR DE TRIM												
<table border="1"> <thead> <tr> <th>REF</th> <th>OEM</th> <th>⚡</th> </tr> </thead> <tbody> <tr> <td>REC87-18286A43</td> <td>87-18286A43</td> <td></td> </tr> <tr> <td>REC87-858679T2</td> <td>87-858679T2</td> <td>12V</td> </tr> <tr> <td>REC87-859032T02</td> <td>87-859032T02</td> <td></td> </tr> </tbody> </table>	REF	OEM	⚡	REC87-18286A43	87-18286A43		REC87-858679T2	87-858679T2	12V	REC87-859032T02	87-859032T02		 <p>REC87-18286A43</p>	 <p>REC87-859032T02</p>	 <p>REC87-858679T2</p>
REF	OEM	⚡													
REC87-18286A43	87-18286A43														
REC87-858679T2	87-858679T2	12V													
REC87-859032T02	87-859032T02														

INTERRUPTORES DE PARO	IGNITION KILL SWITCH	INTERRUTTORE DI STOP	INTERRUPTEUR DE STOP																					
<table border="1"> <thead> <tr> <th>REF</th> <th>OEM</th> <th>⚡</th> </tr> </thead> <tbody> <tr> <td>REC87-91941A8</td> <td>87-91941A8</td> <td>12V</td> </tr> </tbody> </table>	REF	OEM	⚡	REC87-91941A8	87-91941A8	12V	 <p>REC87-91941A8</p>	<table border="1"> <thead> <tr> <th>REF</th> <th>OEM</th> <th>🔑</th> </tr> </thead> <tbody> <tr> <td>REC803623001</td> <td>803623001</td> <td>D/CMD 2.8L</td> </tr> <tr> <td></td> <td>811406</td> <td>D/CMD 4.2L</td> </tr> <tr> <td></td> <td>803623</td> <td>D/CMD 1.7L</td> </tr> <tr> <td></td> <td></td> <td>D254TURBO</td> </tr> </tbody> </table>  <p>REC803623001</p>	REF	OEM	🔑	REC803623001	803623001	D/CMD 2.8L		811406	D/CMD 4.2L		803623	D/CMD 1.7L			D254TURBO	 <p>REC803623001</p>
REF	OEM	⚡																						
REC87-91941A8	87-91941A8	12V																						
REF	OEM	🔑																						
REC803623001	803623001	D/CMD 2.8L																						
	811406	D/CMD 4.2L																						
	803623	D/CMD 1.7L																						
		D254TURBO																						

<table border="1"> <thead> <tr> <th>REF</th> <th>OEM</th> </tr> </thead> <tbody> <tr> <td>REC87-19674A1</td> <td>87-19674A1</td> </tr> </tbody> </table>  <p>REC87-19674A1</p>	REF	OEM	REC87-19674A1	87-19674A1	<table border="1"> <thead> <tr> <th>REF</th> <th>OEM</th> </tr> </thead> <tbody> <tr> <td>REC8M0092849</td> <td>8M0092489</td> </tr> </tbody> </table>  <p>REC8M0092849</p>	REF	OEM	REC8M0092849	8M0092489
REF	OEM								
REC87-19674A1	87-19674A1								
REF	OEM								
REC8M0092849	8M0092489								

ALARMA	ALARM ASSY	KIT ALLARME	BUZZER D'ALARME				
<table border="1"> <thead> <tr> <th>REF</th> <th>OEM</th> </tr> </thead> <tbody> <tr> <td>REC8M0144930</td> <td>8M0144930</td> </tr> </tbody> </table>  <p>REC8M0144930</p>	REF	OEM	REC8M0144930	8M0144930			
REF	OEM						
REC8M0144930	8M0144930						



# SISTEMA ENCENDIDO IGNITION SYSTEM

# SISTEMA DI ACCENSIONE SYSTEME D'ALLUMAGE

BOBINAS	COILS	BOBINE	BOBINES
BOBINA DE ENCENDIDO	IGNITION COIL	BOBINA DI ACCENSIONE	BOBINE D'ALLUMAGE

REF	OEM	
REC300-8M0044991	300-8M0044991 8M0029482	4.5L MPI (3 UN.) 6.2L MPI (4 UN.)

DOBLE SALIDA  
TWIN OUT  
DOPPIA USCITA  
DOUBLE SORTIE



**new**

REF	OEM	
REC806673T1	806673T1 806673T	V8 (5.0 & 5.7L)



REF	OEM	
REC3854002	898253T27 817378 817378T	4 CIL. (V6 & V8)





REF	OEM	
REC3861267	392-881732	Motores 496 Magnum 8.1 Inboard



REF	OEM	
REC3859078	392-889925	8.1L & 496 Mag (OM315053 +)



REF	OEM	
REC3861985	392-863704T 8M0054588	2001+ 4.3, 5.0, 5.7 & 6.2L EMC OM300000+



ENCENDIDO ELECTRONICO	ELECTRONIC IGNITION	ACCESIONE ELETTRONICA	BOBINE D'ALLUMAGE ELECTRONIQUE
NO USA RESISTENCIA EXTERNA HEI Sistema de encendido Thunderbolt	USE WITHOUT EXTERNAL RESISTOR HEI Thunderbolt ignition system	NON UTILIZZA RESISTENZA ESTERNA HEI Sistema di accensione Thunderbolt	N'UTILISE PAS DE RESISTANCE EXTERNE HEI Système d'allumage Thunderbolt

REF	OEM
REC300-00879	392-805570A2 392-7803A4



MERCURISER | CUMMINS

RECAMBIO  
MARINOS

USA RESISTENCIA EXTERNA  
HEI  
DELCO 1115202

USE WITH EXTERNAL RESISTOR  
HEI  
DELCO 1115202

UTILIZZA RESISTENZA ESTERNA  
HEI  
DELCO 1115202

UTILISE UNE RÉSISTANCE EXTERNE  
HEI  
DELCO 1115202

REF	OEM
REC1463-9382	898253T24
	392-806529A1
	32193A2
	38547



## MÓDULOS IGNICIÓN

## IGNITION MODULES

## MODULI AVVIAMENTO

## MODULES D'ALLUMAGE

REF	OEM		BOBINA COIL BOBINA BOBINE
REC3858984	GM10482803	4.3, 5.0, 5.7 Et 6.2L MPI ECM555 (2001+) OM300000+	REC3861985



REF	OEM	
REC3854001	811639T	V4, V6, V8 Delco Voyager



REF	OEM	
REC3854003	811637T	4L, V6 Et V8 Delco Voyager
	811637001	
	81637002	
	811637	
	850487	
	804412 802464	





**BUJÍAS      SPARK PLUG      CANDELE      BOUGIES**

**BUJÍAS      SPARK      CANDELE      BOUGIES**

	CYL	SERIE SERIAL SERIE SERIE	REF
110	4, 153 CID		CHARN5C
110	4, 153 CID		CHARV15YC4
140	4, 181 CID	-3826282	CHARN5C
140	4, 181 CID	3826283	CHARV15YC4
3.0	4, 181 CID	-0F353100	CHARV15YC4
3.0	4, 181CID	0L010042+	CHARS12YC
3.0 LX	4, 181 CID		CHARS12YC
470, 165, 170, 485, 488, 180, 190,	4, 224 CID		CHARS12YC
3.7L, 3.7LX,	4, 224 CID		CHARS12YC
140, 150, 160,	4, 224 CID		CHARS12YC
165	6, 194, 230 & 292 CID	-2771483	CHARN5C
165	6, 194, 230 & 292 CID	2771484	CHARV15YC4
200	6, 194, 230 & 292 CID		CHARN5C
185	V6, 229 CID		CHARV15YC4
175, 185, 205	V6, 262 CID		CHARV15YC4
262 MAG EFI GEN+	V6, 262 CID	0F80800-0L000000	CHARS12YC
4.3L MPI	V6, 262 CID		CHARV15YC4
4.3L	V6, 262 CID	-0F802999	CHARV15YC4
4.3LX	V6, 262 CID	0F802999+	CHARV15YC4
4.3 GEN+	V6, 262 CID	0L010065+	CHARS12YC
4.3LL EFI GEN+	V6, 262 CID	0L012009+	CHARS12YC
4.3LH GEN+	V6, 262 CID	0L010044+	CHARS12YC
4.3LX GEN+	V6, 262 CID	0F803000-0L000000	CHARS12YC
4.3LXH GEN+	V6, 262 CID	0F803000-0L000000	CHARS12YC
888 Culata   Head   Testata   Tête : 14mm FORD V8	CHARV15YC4	4169597	CHARV15YC4
233 Culata   Head   Testata   Tête : 14mm FORD V8	FORD V8		CHARV15YC4
255 Culata   Head   Testata   Tête : 14mm FORD V8	CHARV15YC4	4175499	CHARV15YC4
190	V8 283, 327, 305, 350 CID		CHARJ12YC
898, 200	V8 283, 327, 305, 350 CID		CHARV9IMC
225	V8 283, 327, 305, 350 CID	2278647	CHARJ12YC
228, 230	V8 283, 327, 305, 350 CID		CHARV9IMC
250	V8 283, 327, 305, 350 CID	4768000	CHARV15YC4
255	V8 283, 327, 305, 350 CID		CHARV15YC4
260	V8 283, 327, 305, 350 CID		CHARV9IMC
280, 300 Tempest, 320 EFI	V8 283, 327, 305, 350 CID		CHARV15YC4
350 Mag (Carb)	V8 283, 327, 305, 350 CID		CHARV9IMC
350 Mag EFI/MP	V8 283, 327, 305, 350 CID	-0F602199	CHARV9IMC
350 Mag EFI GEN+ V8	CHARS12YC	0F800500+	CHARS12YC
350 Mag MPI GEN+ V8	CHARS12YC	0F602000+	CHARS12YC
350 Mag MPI GEN+ V8	CHARS12PYP	0L604000+	CHARS12PYP
377 Scorpion	V8 283, 327, 305, 350 CID	0L416146+	CHARS12YC
5.0L MPI	V8 283, 327, 305, 350 CID		CHARS12YC
5.0L	V8 283, 327, 305, 350 CID	- 0L000000	CHARV9IMC
5.0L GEN+	V8 283, 327, 305, 350 CID	0L015751	CHARS12YC
5.0L EFI GEN+	V8 283, 327, 305, 350 CID	0L012052	CHARS12YC
5.0LX	V8 283, 327, 305, 350 CID		CHARV9IMC
5.7L	V8 283, 327, 305, 350 CID	-0L000000	CHARV9IMC
5.7L EFI	V8 283, 327, 305, 350 CID	-0L000000	CHARV9IMC
5.7L GEN+	V8 283, 327, 305, 350 CID	0L010037+	CHARS12YC
5.7L EFI GEN+	V8 283, 327, 305, 350 CID	0L010035+	CHARS12YC
5.7LX, 5.7LX EFI	V8 283, 327, 305, 350 CID		CHARV9IMC
5.7LX EFI GEN+	V8 283, 327, 305, 350 CID		CHARS12YC
325	V8 427, 454 & 482 CID	3043030	CHAV63C
330, 330 (B-W), 370, 400, 400 Cyclone	V8 427, 454 & 482 CID		CHARV15YC4
420, HP425, 440 Cyclone, HP450	V8 427, 454 & 482 CID		CHARV15YC4
454 Mag Alpha, Bravo, EFI/MP/MPI	V8 427, 454 & 482 CID		CHARV15YC4
460 Cyclone, 475 Turbo, HP525 SC	V8 427, 454 & 482 CID		CHAV63C
7.4L Alpha, 7.4L Bravo	V8 427, 454 & 482 CID		CHARV15YC4
7.4L TR	V8 427, 454 & 482 CID	0B771113-0C407646	CHARV15YC4
7.4L MPI (L29)	V8 427, 454 & 482 CID	0L010003+	CHARS12YC
7.4LX EFI, 7.4LX MPI	V8 427, 454 & 482 CID		CHARV15YC4
HP465, HP500 (502 CID), HP500 EFI	V8 502, 540 & 572 CID		CHARV15YC4
HP500 Bulldog 540, HP525 SC 454	V8 502, 540 & 572 CID		CHAV63C
HP575, HP600SC Bobtail (502 CID)	V8 502, 540 & 572 CID		CHAV63C
HP800SC (572 CID)	V8 502, 540 & 572 CID		CHAV63C
502 MAG (CARB.), EFI/MA/MPI	V8 502, 540 & 572 CID		CHARV15YC4
600SC, 800SC	V8 502, 540 & 572 CID		CHAV63C



REF  
CHAPROSU

MERCUISER | CUMMINS

RECAMBIOS  
MARINOS



## BUJÍAS

## SPARK

## CANDELE

## BOUGIES

	CYL	IGNITION TYPE	year	SERIE	REF	S.P GAP
100 Vazer	98/L4	Delco- HEI	2007-09	1A035000 +	NGKBR9ES	.035
110	153/ L4	Delco	1963-66	1537370 - 2044033	NGKBR6ES	.035
120	153/ L4	Delco	1964-74	1666601 - 3825578	NGKBR6ES	.035
120	153/ L4	Delco	1974-86	3825579 - 0B531853	NGKBR6FS	.035
2.5L	153/ L4	Delco	1987-89	0B531854- 0C853255	NGKBR6FS	.035
140	181/ L4	Delco	1968-74	2508261 - 3826282	NGKBR6ES	.035
140	181/ L4	Delco	1974-86	3826283 - 0B450800	NGKBR6FS	.035
3.0L	181/ L4	Delco	1987-89	0B450801 - 0C856558	NGKBR6FS	.035
3.0L	181/ L4	Prestolite	1990-91	0C856559 - 00504541	NGKBR6FS	.035
3.0L	181/ L4	Delco Digital	1990-91	0C856559 - 00504541	NGKBR6FS	.035
3.0L	181/ L4	EST	1991-94	0D504542 - 0F603999	NGKBPR6EFS	.035
3.0L	181/ L4	EST	1998	0L010042 - 0L340999	NGKBPR6EFS	.035
3.0L	181/ L4	EST	1999-16	0L341000 - 2A506300	NGKBPR6EFS	.045
3.0L MPI	181/ L4	EST	2008-16	1A072812 - 2A502810	NGKBPR6EFS	.045
3.0LX	181/ L4	Prestolite	1990-91	0C856559 - 0D504541	NGKBR6FS	.035
3.0LX	181/ L4	Delco Oigital	1990-91	0C856559 - 0D504541	NGKBPR6EFS	.035
3.0LX	181/ L4	EST	1991-97	0D504542 - 0K999999	NGKBPR6EFS	.035
165	224/ L4	Delco	1987	0B434940 - 0B77451	NGKBPR6FS	.035
170	224/ L4	Delco	1985-86	6916779 - 0B434940	NGKBPR6FS	.035
180	224/ L4	Delco & Prestolite	1987	0B436391 - 0B775248	NGKBPR6FS	.035
190	224/ L4	Delco	1985-86	6916779 - 0B436390	NGKBPR6FS	.035
3.7L	224/ L4	Delco	1988-89	0B774252+	NGKBPR6FS	.035
3.7LX	224/ L4	Delco & Prestolite	1988-89	0B775249+	NGKBPR6FS	.035
470	224/ L4	Delco	1976-84	4208730 - 6916778	NGKBPR6FS	.035
485	224/ L4	Delco	1980-82	5685394 - 6218036	NGKBPR6FS	.035
488	224/ L4	Delco	1983-84	6170297 -6916778	NGKBPR6FS	.035
140	194/ L6	Delco	1963	1538930 - 1725960	NGKBR6ES	.035
150	230/ L6	Delco	1964-66	1666495 - 2048046	NGKBR6ES	.035
160	250/ L6	Delco	1967-69	2048022 - 2770031	NGKBR6ES	.035
165	250/ L6	Delco	1970	2770032 - 2771483	NGKBR6ES	.035
165	250/ L6	Delco	1971-81	2771484 - 5813433	NGKBR6FS	.035
200	292/ L6	Delco	1969	2453769 - 2712072	NGKBR6ES	.035
185 (4 bbl.)	229/ V-6	Prestolite	1983-84	6330183 - 6919655	NGKBR6FS	.035
175	262/ V-6	Thunderbolt IV	1987	0B527955 - 0B773242	NGKBR6FS	.035
185 (2 bbl.)	262/ V-6	Thunderbolt IV	1985-87	6919656 - 0B527954	NGKBR6FS	.035
205	262/ V-6	Thunderbolt IV	1985-87	0A331455-0B775129	NGKBR6FS	.035
262 Mag.(TBI)(Gen+)	262/ V-6	Delco -HEI	1996-97	0F803800 - 0K999999	NGKBPR6EFS	.045
4.3L	262/ V-6	Thunderbolt IV	1988-93	0B773243 - 0F000877	NGKBR6FS	.035
4.3L	262/ V-6	Thunderbolt IV	1993-96	0F000878 - 0F802999	NGKBR6FS	.040
4.3L (Gen +)	262/ V-6	Thunderbolt V	1998-04	0L010044- 0W300012	NGKBPR6EFS	.045
4.3L TKS	262/ V-6	Thunderbolt V	2004-15	0W300013- 2A454127	NGKBPR6EFS	.045
4.3L EFI (Gen+)(TBI)	262/ V-6	Delco & Mercury - HEI	1998-01	0L012009- 0M299999	NGKBPR6EFS	.045
4.3L MPI	262/ V-6	Delco - HEi	2002-16	0M300000 - 2A506375	NGKITR4A15	.060
4.3L MPI EC	262/ V-6	Delco -HEi	2011-16	1A637496 - 2A528897	NGKITR4A15	.060
4.3LH (Gen +)	262/ V-6	Thunderbolt IV	1998-02	0L010044- 0M614999	NGKBPR6EFS	.045
4.3LX	262/ V-6	Thunderbolt IV	1988-93	08775130-0F001219	NGKBR6FS	.035
4.3LX	262/ V-6	Thunderbolt IV	1993-96	0F001220 - 0F802999	NGKBR6FS	.040
4.3LX (Gen +)	262/ V-6	Thunderbolt IV	1996-97	0F803000 - 0K999999	NGKBPR6EFS	.045
4.3LXH (Gen +)	262/ V-6	Thunderbolt IV	1996-97	0F803000 - 0K999999	NGKBPR6EFS	.045
4.5L MPI	275/ V6	Mercury	2014-21	2A441953 and up	NGKBPR5EFS-13	.051
198 MIE	305/ V-8	Mallory	1977	4776402 - 4931099	NGKBR6FS	.035
200	305/ V-8	Thunderbolt IV	1985-87	6899058 - 0B774444	NGKBR6FS	.035
228	305/ V-8	Mallory	1977-82	4765100- 6218461	NGKBR6FS	.035
228	305/ V-8	Thunderbolt IV	1983-84	6218462 - 6899268	NGKBR6FS	.035
228 MIE	305/ V-8	Mallory	1977-80	4765100- 5907057	NGKBR6FS	.035
230	305/ V-8	Thunderbolt IV	1985-87	6899269 - 0B773739	NGKBR6FS	.035
230 MIE (LH)	305/ V-8	Thunderbolt IV	1981-87	5907058 - 0B788151	NGKBR6FS	.035
230 MIE (RH)	305/ V-8	Thunderbolt IV	1981-87	5907058 - 0B788151	NGKBR6FS	.035
5.0L	305/ V-8	Thunderbolt IV	1988-95	0B774445 - 0F600999	NGKBR6FS	.035
5.0L (Gen+)	305/ V-8	Thunderbolt V	1998-04	0L015751 - 0W300009	NGKBPR6EFS	.045
5.0L TKS	305/ V-8	Thunderbolt V	2004-10	0W300010-1A607561	NGKBPR6EFS	.060
5.0L EFI (Gen +)	305/ V-8	Delco & Mercury- HEi	1998-01	0L012052 - 0M299999	NGKBPR6EFS	.045



	CYL	IGNITION TYPE	year	SERIE	REF	S.P GAP
5.0L MIE (LH)	305/ V-8	Thunderbolt IV	1988	0B788152 - 0C396832	NGKBR6FS	.035
5.0L MIE (RH)	305/ V-8	Thunderbolt IV	1988	0B788152 - 0C396832	NGKBR6FS	.035
5.0L MPI	305/ V-8	Delco-HEI	2002-14	0M300000 - 2A445009	NGKITR4A15	.060
5.0L MPI EC	305/ V-8	Delco-HEI	2008-14	1A300000 - 2A444777	NGKITR4A15	.060
5.0LX	305/ V-8	Thunderbolt IV	1988-95	0B773740 - 0F600999	NGKBR6FS	.035
898	305/ V-8	Mallory	1977-82	4762210 - 6218461	NGKBR6FS	.035
898	305/ V-8	Thunderbolt IV	1983-84	6218462 - 6899057	NGKBR6FS	.035
250	350/ V-8	Mallory	1977	4768000 - 4908849	NGKBR6FS	.035
255 MCM & MIE (GM)	350/ V-8	Mallory & Mercury	1975-76	3258728 - 4767999	NGKBR6FS	.035
260	350/ V-8	Mallory	1978-82	4908850 - 6218461	NGKBR6FS	.035
260	350/ V-8	Thunderbolt IV	1982-87	6218462 - 0B773304	NGKBR6FS	.035
260 MIE (LH)	350/ V-8	Thunderbolt IV	1981-87	5907058 - 0B788151	NGKBR6FS	.035
260 MIE (RH)	350/ V-8	Thunderbolt IV	1981-87	5907058 - 0B788151	NGKBR6FS	.035
280 TRS	350/ V-8	Mercury	1975	4176250 - 4499390	NGKBR6FS	.035
280 TRS	350/ V-8	Mallory	1976	4499391 - 4770199	NGKBR6FS	.035
300	350/ V-8	Thunderbolt IV	1985-86	6668677 - 0B430367	NGKBR6FS	.035
320 EFI	350/ V-8	Thunderbolt IV	1987-89	0A543604-0C622418	NGKBR6FS	.035
350 Mag. Alpha	350/ V-8	Thunderbolt IV & V	1986-97	0A635178 - 0K999999	NGKBR6FS	.035
350 Mag. Alpha EFI (Gen+)	350/ V-8	Delco-HEI	1996	0K001509-0K999999	NGKBPR6EFS	.045
350 Mag. Bravo MPI	350/ V-8	Delco-HEI	1995	0F415189 - 0F601999	NGKBR6FS	.035
350 Mag. Bravo MPI (Gen+)	350/ V-8	Delco- HEI	1996-97	0F602000 - 0K999999	NGKBPR6EFS	.045
350 Mag. EFI Ski	350/ V-8	Delco- HEI	1994-97	0F215561-0K999999	NGKBPR6EFS	.045
350 Mag. MPI (Gen+)	350/ V-8	Delco- HEI	1998	0L010019 - 0L325952	NGKBPR6EFS	.045
350 Mag. MPI (Gen+)	350/ V-8	Mercury-HEI	1999-01	0L325953 - 0M299999	NGKBPR6EFS	.045
350 Mag. MPI	350/ V-8	Delco-HEI	2002-5	0M300000 - 2A455872	NGKITR4A15	.060
350 Mag. MPI EC	350/ V-8	Delco-HEI	2008-15	1A300000 - 2A455878	NGKITR4A15	.060
350 Mag. MPI Horizon	350/ V-8	Delco-HEI	2002-07	0M300000 +	NGKITR4A15	.060
350 Mag. MPI Horizon MIE	350/ V-8	Mercury-HEI	1999-01	0L304700 - 0M299999	NGKTR5IX	.045
350 Mag. MPI Horizon MIE	350/ V-8	Delco- HEI	2002-07	0M300000 - 1A089999	NGKITR4A15	.060
350 Mag. MPI MIE (Gen+)	350/ V-8	Delco- HEI	1998	0L002008 - 0L302199	NGKBPR6EFS	.045
350 Mag. MPI MIE (Gen+)	350/ V-8	Mercury-HEI	1998-01	0L302200 - 0M299999	NGKBPR6EFS	.045
350 Mag. MPI MIE	350/ V-8	Delco-HEI	2002-07	0M300000 - 1A089999	NGKITR4A15	.060
350 Mag. MPI Ski	350/ V-8	Delco-HEI	1995-96	0F350583 - 0F799999	NGKBR6FS	.035
350 Mag. MPI Ski (Gen+)	350/ V-8	Delco-HEI	1998	0L002600 - 0L304599	NGKBPR6EFS	.045
350 Mag. MPI Ski (Gen+)	350/ V-8	Mercury-HEI	1999-01	0L304600 - 0M299999	NGKBPR6EFS	.045
350 Mag. MPI Ski	350/ V-8	Delco-HEI	2002-07	0M300000 - 1A089999	NGKITR4A15	.060
350 Mag. Ski	350/ V-8	Thunderbolt IV& V	1991-97	0D505450 - 0K999999	NGKBR6FS	.035
5.7L	350/ V-8	Thunderbolt IV& V	1988-97	0B773305 - 0K999999	NGKBR6FS	.035
5.7L (Gen+)	350/ V-8	Thunderbolt V	1998-04	0L010037 - 0W300754	NGKBPR6EFS	.045
5.7L TKS	350/ V-8	Thunderbolt V	2004-09	0W300755-1A600136	NGKBPR6EFS	.060
5.7L EFI	350/ V-8	Delco-HEI	1995-97	0F225560 - 0K999999	NGKBR6FS	.035
5.7L EFI (Gen +)	350/ V-8	Delco & Mercury - HEI	1998-01	0L010035 - 0M299999	NGKBPR6EFS	.045
5.7L EFI MIE (Gen+)	350/ V-8	Delco- HEI	1997	0K040300 - 0K999999	NGKBPR6EFS	.045
5.7L MIE (LH)	350/ V-8	Thunderbolt IV	1988-93	0B788152 - 0F024999	NGKBR6FS	.035
5.7L MIE (RH)	350/ V-8	Thunderbolt IV	1988-93	0B788152 - 0F024999	NGKBR6FS	.035
5.7L MIE	350/ V-8	Thunderbolt IV	1993-95	0F025000 - 0K999999	NGKBR6FS	.035
5.7L MIE (Gen+)	350/ V-8	Thunderbolt V	1998-04	0L002003 - 0W090899	NGKBPR6EFS	.045
5.7L MIE TKS	350/ V-8	Thunderbolt V	2004-10	0W090900 - 1A092388	NGKBPR6EFS	.060
5.7L MPI Horizon MIE	350/ V-8	Delco-HEI	2008-15	1A090000- 2A455371	NGKITR4A15	.060
5.7L MPI MIE	350/ V-8	Delco-HEI	2008-15	1A090000 - 2A455523	NGKITR4A15	.060
5.7L MPI MIE EC	350/ V-8	Delco-HEI	2008-16	1A090000- 2A455371	NGKITR4A15	.060
5.7L MPI Tow Sports	350/ V-8	Delco-HEI	2008-16	1A090000 - 2A455977	NGKITR4A15	.060
5.7L MPI Tow Sports EC	350/ V-8	Delco-HEI	2008-15	1A090000 - 2A452508	NGKITR4A15	.060
5.7LSki	350/ V-8	Prestolite & Mallory	1985-95	0A338553-0F775199	NGKBR6FS	.035
5.7LSki	350/ V-8	Thunderbolt IV& V	1987-97	0B514627 - 0K999999	NGKBR6FS	.035
5.7LSki	350/ V-8	Thunderbolt V	1998-04	0L002005 - 0W090899	NGKBPR6EFS	.045
5.7L Ski TKS	350/ V-8	Thunderbolt V	2004-11	0W090900 - 1A092837	NGKBPR6EFS	.060
5.7LX	350/ V-8	Thunderbolt V	1996-97	0F601000 - 0K999999	NGKBR6FS	.035
5.7LX Bravo EFI (Gen +)	350/ V-8	Delco-HEI	1996-97	0F800300 - 0K999999	NGKBPR6EFS	.045
5.7LX EFI	350/ V-8	Delco- HEI	1996-97	0F752400 - 0K999999	NGKBR6FS	.035
Black Scorpion Ski (Gen+)	350/ V-8	Delco-HEI	1996-02	0F800000 - 0M391599	NGKBPR6EFS	.045
Black Scorpion Ski (Gen+)	350/ V-8	Delco-HEI	2003-07	0M391600 - 0W698432	NGKITR4A15	.060
Scorpion 350	350/ V-8	Delco- HEI	2008-15	0W698433 - 2A460164	NGKITR4A15	.060
Scorpion 350 EC	350/ V-8	Delco- HEI	2008-15	0W698433 - 2A460148	NGKITR4A15	.060

	CYL	IGNITION TYPE	year	SERIE	REF	S.P GAP
377 Mag	377/ V-8	Delco-HEI	2008-15	1A300000 - 2A455858	NGKITR4A15	.060
377 Mag EC	377/ V-8	Delco-HEI	2008-15	1A300000 - 2A455601	NGKITR4A15	.060
377 Scorpion MCM	377/ V-8	Delco- HEi	1999-05	0L416146 - 0M907201	NGKBPR6EFS	.045
377 Scorpion Ski	377/ V-8	Delco -HEi	1997-98	0K000656 - 0L600314	NGKBPR6EFS	.045
6.2L MPI (Mercury)	377/ V-8	Mercury	2015-21	2A456613 +	NGKBPR5EFS-13	.051
MX 6.2L MPI	377/ V-8	Mercury-HEI	2000-01	0L680003 - 0M299999	NGKBPR6EFS	.045
MX 6.2L MPI	377/ V-8	Delco -HEi	2002-07	0M300000 - 1A299999	NGKITR4A15	.060
MX 6.2L MPI Horizon	377/ V-8	Delco -HEi	2002-07	0M300000 +	NGKITR4A15	.060
MX 6.2L MPI Horizon MIE	377/ V-8	Delco -HEi	2002-15	0M300000 - 2A452368	NGKITR4A15	.060
MX 6.2L MPI MIE	377/ V-8	Mercury-HEI	1999-01	0L670000 - 0M299999	NGKBPR6EFS	.045
MX 6.2L MPI MIE	377/ V-8	Delco -HEi	2002-07	0M300000 +	NGKITR4A15	.060
6.2L MPI MIE EC	377/ V-8	Delco -HEi	2008-15	1A090000 - 2A455246	NGKITR4A15	.060
MX 6.2L MPI Ski	377/ V-8	Delco -HEi	2002-07	0M317000 - 0W689999	NGKITR4A15	.060
MX 6.2L Blk Scorpion Ski	377/ V-8	Delco -HEi	2001-02	0L670015- 0M391599	NGKBPR6EFS	.045
MX 6.2L Blk Scorpion Ski	377/ V-8	Delco -HEi	2003-07	0M391750 - 0W698432	NGKITR4A15	.060
Scorpion 377	377/ V8	Delco -HEi	2008-15	0W698433 - 2A460138	NGKITR4A15	.060
Scorpion 377 HO EC	377/ V-8	Delco-HEI	2009-10	1A091488-1A092170	NGKITR4A15	.060
330 MCM&t MIE	454/ V-8	Malklry	1977-81	4623115-6083144	NGKBR6FS	.035
330	454/ V-8	Thunderbolt IV	1982-87	6083145- 0B816540	NGKBR6FS	.035
340 MIE	454/ V-8	Thunderbolt IV	1981-87	5889914 - 0B788365	NGKBR6FS	.035
370 TRS	454/ V-8	Halley	1978-85	4883520 - 6721527	NGKBR6FS	.035
370 TRS	454/ V-8	Thunderbolt IV	1985-87	6721528 - 0B714586	NGKBR6FS	.035
400 TRS	454/ V-8	Halley	1980-86	5668232 - 0B457644	NGKBR6FS	.035
420	454/ V-8	Thunderbolt IV	1987-89	0A398941 - 0B622418	NGKBR6FS	.035
425	454/ V-8	Thunderbolt IV	1990-93	0B622419- 0D937011	NGKBR6FS	.035
440 TRS	454/ V-8	Halley	1983-86	6181070- 0B485220	NGKBR6FS	.035
450	454/ V-8	Thunderbolt IV	1995-96	0F347100- 0F347277	NGKBR6FS	.035
454 Mag. Alpha	454/ V-8	Thunderbolt IV	1986-88	0A631894- 0B785148	NGKBR6FS	.035
454 Mag. Bravo	454/ V-8	Thunderbolt IV	1988-97	0B721206- 0K999999	NGKBR6FS	.035
454 Mag. EFI	454/ V-8	Delco- HEi	1994-96	0F115700 - 0F802349	NGKBR6FS	.035
454 Mag. EFI Ski	454/ V-8	Delco- HEi	1995-96	0F215800 - 0F820099	NGKBR6FS	.035
454 Mag. MPI	454/ V-8	Delco- HEi	1996-01	0F802350 - 0M024999	NGKBR6FS	.040
454 Mag. MPI Horizon MIE	454/ V-8	Delco- HEi	1998-01	0L002200 - 0L674000	NGKBR6FS	.040
454 Mag. MPI Ski	454/ V-8	Delco- HEi	1996-97	0F820100 - 0K999999	NGKBR6FS	.040
525 SC	454/ V-8	Thunderbolt IV	1991-99	0D456000- 0L415623	NGKBR6FS	.035
7.4L Bravo	454/ V-8	Thunderbolt IV	1988-97	0B771113- 0K999999	NGKBR6FS	.035
7.4L EFI MIE	454/ V-8	Delco- HEi	1996-97	0F874815 - 0K999999	NGKBR6FS	.035
7.4L MIE	454/ V-8	Thunderbolt IV & V	1981-97	5889914 - 0K999999	NGKBR6FS	.035
7.4L MPI (L29)	454/ V-8	Delco- HEi	1998-01	0L010003 - 0M024330	NGKBPR6EFS	.045
7.4L MPI MIE	454/ V-8	Delco-HEI	1995-97	0F563052 - 0K999999	NGKBR6FS	.035
7.4L MPI MIE (L29)	454/ V-8	Delco- HEi	1998-01	0L002006 - 0L674613	NGKBPR6EFS	.045
7.4LX Bravo EFI	454/ V-8	Delco- HEi	1996-97	0F820000 - 0K999999	NGKBR6FS	.035
7.4LX Bravo MPI	454/ V-8	Delco-HEI	1996-97	0F602010 - 0K999999	NGKBR6FS	.035
496 Mag &t HO EC	496/ V-8	Delco	2001-10	0M025000 - 1A352731	NGKPZTR5A-15	.060
496 Mag &t HO EC	496/ V-8	Delco	2008-10	1A066166 - 1A350440	NGKPZTR5A-15	.060
8.1S&t HO MIE	496/ V-8	Delco	2001-10	0M026000 - 1A380318	NGKPZTR5A-15	.060
8.1S&t HO MIE EC	496/ V-8	Delco	2008-10	0W697154-1A380251	NGKPZTR5A-15	.060
500	502/ V-8	Thunderbolt IV	1994-98	0F213293-0L001772	NGKBR6FS	.035
500 (Gen+)	502/ V-8	Thunderbolt IV	1999	0L414639 - 0L601036	NGKBR6FS	.035
500 EFI	502/ V-8	Delco- HEi	1998-05	0L001477 +	NGKBR6FS	.035
502 Mag.	502/ V-8	Thunderbolt IV	1990-93	0C878221 - 0F114528	NGKBR6FS	.035
502 Mag. EFI	502/ V-8	Delco-HEI	1993-96	0D840650 - 0F802599	NGKBR6FS	.035
502 Mag. MPI	502/ V-8	Delco- HEi	1996-01	0F802600 - 0M024999	NGKBR6FS	.040
525 EFI	502/ V-8	Mercury- HEi	2003-21	0M900146 +	NGKBPR6ES	.035
600 SC	502/ V-8	Thunderbolt IV	1991-93	0D456489 - 0D763875	NGKBR6FS	.035
8.2L Mag	502/ V-8	Mercury- HEi	2010-21	1A351597 +	NGKBPR6ES	.060
8.2L Mag EC	502/ V-8	Mercury- HEi	2010-21	1A350340 +	NGKBPR6ES	.060
8.2L MIE	502/ V-8	Thunderbolt IV &t V	1990-96	0C878221 - 0F819629	NGKBR6FS	.035
8.2L MIE	502/ V-8	Mercury - HEI	2010-21	1A350802+	NGKBPR6ES	.060
8.2L MIE EC	502/ V-8	Mercury - HEI	2010-21	1A350802 +	NGKBPR6ES	.060
8.L MPI MIE	502/ V-8	Delco- HEi	1996-01	0F819620 - 0L674200	NGKBR6FS	.040
500 Bulldog	540/ V-8	Thunderbolt IV	1990-96	0C577003 - 0F745405	NGKBR6FS	.035
500 Bulldog	540/ V-8	Thunderbolt IV	1997-01	0K000248 - 0M050281	NGKBR6FS	.040



## JUEGOS DE CABLES, ALTO RENDIMIENTO

Núcleo del cable de Kevlar de 8 mm antimagnético. Funda de silicona amarilla. Terminales bujías con muelle de acero inox. Terminal del distribuidor de cobre. Terminales bobina. Silicona resistente a altas temperaturas. Garantía de 5 años.

## HD SPARK PLUG WIRE SET

Antimagnetic Kevlar core. Yellow silicone boot Et jacket. SS snaplock. Brass distributor terminal. Coil terminals. High resistant silicone. 5 year warranty.

## KIT CAVI CANDELE, ALTE PRESTAZIONI

Nucleo del cavo di Kevlar da 8 mm antimagnético. Copertura di silicone gialla. Terminali candele con molle di acciaio inox. Terminale lato spinterogeno in rame. Terminale Bobine. Silicone resistente alle alte temperature. Garanzia di 5 anni.

## KIT FAISCEAU DE BOUGIE

Noyau en Kevlar antimagnétique. Gaine en silicone jaune. Bornes de bougie d'allumage avec ressort en acier inoxydable. Terminal de distribution en laiton. Bornes de bobine. Silicone haute résistance. Garantie de 5 ans.

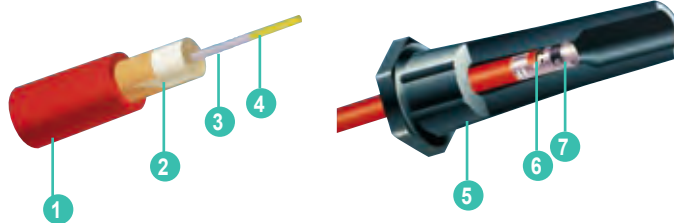

1	Camisa de silicona de 8 mm	8 mm silicone jacket	Rivestimento in silicone da 8 mm	Gaine silicone de 8mm
2	Látex resistente altas temperaturas	Heat resistant latex	Latex resistente alle alte temperature	Latex résistant à haute température
3	Acero inox	Stainless Steel	Acciaio inox	Acier inox
4	Núcleo de Kevlar	Kevlar core	Nucleo de Kevlar	Noyau de Kevlar
5	Capuchón de silicona	Silicone jacket	Rivestimento in silicone	Capuchon en silicone
6	Trenzado especial fibra de vidrio	Fiberglass braiding	Fibra di vetro	Tresse en fibre de verre
7	Terminal de acero inox	Stainless Steel terminal	Terminale di acciaio inox	Terminal en acier inox

Cyl	ARRANQUE IGNITION AVVIAMENTO DEMARRAGE				OEM
	CONVEN.	ELECT.	REF		
110/120/2.5L 140/3.0L	4	✓	REC15-401	84-813720A5	
120/2.5L 140/3.0L 3.0LX	4	✓	REC15-405	84-813720A13	
140-185(EN LINEA 6)	6	✓	MAG15-602	84-813720A8 84-816761Q8	
165-180 LX/470- 485 190 (3.7L)	4	✓	REC15-402	84-813720A5	
175/185 (228, 262) 4.3L (GENI)	6	✓	REC15-601	84-813720A11	
185 (229)	6	✓	REC15-604	84-813720A7 84-816761Q7 84-813720A8	
180 (GM)	8	✓	REC15-801	84-813720A10 84-813720A4 84-818781A4 84-8167681A17 84-813720A3	
200/5.0L (GM)	8	✓	REC15-804	84-813720A8 84-813720A10 84-813720A4 84-816761A4 84-816878A17 84-813720A3 84-813720A8 84-813720A10	
4.3L 2002 + MPI 215-225S 223FORD 225-228GM	6 8	✓	REC15-606 REC15-801	84-813720A8 84-813720A10 84-813720A4 84-816761A4 84-816878A17 84-813720A3 84-813720A8 84-813720A10	
228-230/5.0L LX (GM)	8	✓	REC15-804	84-813720A3 84-813720A8 84-813720A10	
255 (FORD) 250-225- 225-280(GM)	8	✓	REC15-801	84-813720A10	
5.0L GENE+ 2002+ MPI	8	✓	REC15-815	84-816608A1 84-813720A2 84-816781A4 84-816761A17 84-813720A3	
350 (5.7L) MAG., SKI	8	✓	REC15-804	84-816608A1 84-813720A8 84-813720A10 84-816761A2	
5.7L GENE+ 2002+ MPI	8	✓	REC15-815	84-816608A1 84-813720A8 84-813720A10 84-816761A2	
270/280/350 (GM)	8	✓	REC15-801	84-813720A10 84-816761A2	
300MR/TRS (GM)	8	✓	REC15-804	84-816781A15 84-816761A6 84-816761A15 84-813720A4 84-816781A4 84-816761A17 84-813720A3 84-813720A8 84-813720A10 84-816761A2	
260/320/325 /330/340 (GM)	8	✓	REC15-804	84-816781A15 84-816761A6 84-816761A15 84-813720A4 84-816781A4 84-816761A17 84-813720A3 84-813720A8 84-813720A10 84-816761A2	
370/380/400/ 440/460 TRS	8	✓	REC15-801	84-816781A15 84-816761A8 84-816761A15 84-816761A2	
420/425/486 /525/575	8	✓	REC15-804	84-816781A15 84-816761A8 84-816761A15 84-816761A2	
454/500/502 MAG BRAVO	8	✓	REC15-804	84-816781A15 84-816761A8 84-816761A15	

Cyl	ARRANQUE IGNITION AVVIAMENTO DEMARRAGE				OEM
	CONVEN.	ELECT.	REF		
888 (FORD) 898,198 (GM)	8	✓	REC15-801	84-813720A8 84-813720A10 84-816761A2	
888 (GM) 5.7 BRAVO	8	✓	REC15-804	84-816781A15 84-816761A8 84-816761A15 84-813720A9 84-813720A10 84-816761A2	
5.7 SKI	8	✓	REC15-801	84-813720A9 84-813720A10 84-816761A2	
7.4L BRAVO	8	✓	REC15-804	84-816781A15 84-816761A8 84-816761A15 84-816761A2	
7.4L 8.2L CON HURTH	8	✓	REC15-804	84-816781A15 84-816761A8 84-816761A15 84-816761A2	
300 MR/TRS (GM)	8	✓	REC15-804	84-816781A15 84-816761A6 84-816761A15 84-816761A2	
330-340 (GM)	8	✓	REC15-804	84-816781A15 84-816761A6 84-816761A15 84-816761A2	
454 MAG BRAVO 420/425/465 /525/575	8	✓	REC15-804	84-816781A15 84-816761A6 84-816761A15 84-816761A2	
898 (GM) 5.7 BRAVO	8	✓	REC15-804	84-816781A15 84-816761A6 84-816761A15 84-816761A2	
500/502 BRAVO	8	✓	REC15-804	84-816781A15 84-816761A6 84-816761A15 84-816761A2	
500/502 BRAVO	8	✓	MAG15-803	84-816781A15 84-816761A6 84-816761A15 84-816761A2	
7.4L BRAVO 7.4L-8.2L CON HURTH	8	✓	REC15-804	84-816781A15 84-816761A6 84-816761A15 84-816761A2	
7.4L BRAVO 7.4L-8.2L CON HURTH	8	✓	REC15-804	84-816781A15 84-816761A6 84-816761A15 84-816761A2	
6.2L MPI MIE 454 MAGNUM 8.1L 496	8	✓	REC15-813 MAG15-809 REC15-808	84-863656A1	

DISTRIBUIDOR

DISTRIBUTOR

SPINTEROGENO

ALLUMEUR

TAPA DISTRIBUIDOR

DISTRIBUTOR CAPS

CALOTTE SPINTEROGENO

TÊTE D'ALLUMEUR

REF	OEM	
REC33708	33708	Delco V8



REF	OEM	
REC393-4988	393-4988 393-3230 393-4988T 393-4988T2	Autolite 8 Cyl



REF	OEM	
REC33765T	33765T 33765	Delco 6 Cil



REF	OEM	
REC805759Q01	805759Q01 805759A2 805759A1 90746A1 805759A5 805759T2 805759T1 16457A4 805759T2 43557A1 43557	Merc. V8



REF	OEM	
REC982209	391-5075 391-5075Q1 F16900148	Mallory V8

Tapa alta  
High cap  
Calotta alta  
Couvercle haute



REF	OEM	
REC815407A2	815407A2 13753A2 815407Q02	Merc. V6



REF	OEM	
REC392-9086T	392-9086 392-9086T	Prestolite V6



REF	OEM	
REC985218	(1987-90) Ford 2.3L Mallory	



REF	OEM	
REC835702	392-6318 392-6318T F16900184	Prestolite V8

Con clip  
with clip  
con clip  
Avec clip



REF	OEM		ROTOR ROTOR ROTORE DOIGT D'ALLUMEUR
REC3854331	850484T2 850484T 850484	Delco V6 E. elect.	REC3854311



REF	OEM	
REC392-9766	392-9766 392-9766Q1 392-9766T F16900185	Prestolite V8

Con tornillo  
with nut  
con chiusura a vite  
Avec vis



REF	OEM		ROTOR ROTOR ROTORE DOIGT D'ALLUMEUR
REC3854260	811635T3	Delco 4 cil 3.0LX	REC3854261



REF	OEM		ROTOR ROTOR ROTORE DOIGT D'ALLUMEUR
REC3854548	808483T3 808483 804483T 804418	Delco V8 E. elect.	REC3854549



REF	OEM	
REC393-9459Q1	393-9459Q1 393-3230 393-4988T 393-4988T2	Delco 4 Cil





REF	OEM	ROTOR ROTOR ROTORE DOIGT D'ALLUMEUR
REC898253T23	888731 898253T23	4.3L Vortec V6 MPI REC898253013



REF	OEM	ROTOR ROTOR ROTORE DOIGT D'ALLUMEUR
REC898253T22	884792 898253T22	Vortec V8 MPI Modernos   Late   Moderna   Modernes REC898253013



ROTORES	ROTORS	ROTORI	DOIGT D'ALLUMEUR
---------	--------	--------	------------------

REF	OEM	ROTOR ROTOR ROTORE DOIGT D'ALLUMEUR
REC898253013	898253013 884790 8M6001222	Vortec V6 & V8 MPI



REF	OEM	ROTOR ROTOR ROTORE DOIGT D'ALLUMEUR
REC58217	58217 898253008 58217Q 8M6001251	Delco 4 & 6 Cil



REF	OEM	ROTOR ROTOR ROTORE DOIGT D'ALLUMEUR
REC8M6001252	898253009 8M6001252	GM V8 HEI 1998+ MPI 555 ECM



REF	OEM	ROTOR ROTOR ROTORE DOIGT D'ALLUMEUR
REC89825302	391-5088 391-7057 898253029 391-7057T 8M6001224 FI6901224	Mallory V8



REF	OEM	ROTOR ROTOR ROTORE DOIGT D'ALLUMEUR
REC834975	392-6326 392-6326T FI6900044	Prestolite V8



REF	OEM	ROTOR ROTOR ROTORE DOIGT D'ALLUMEUR
REC65864	65864 78016	Autolite V8 Mercury



REF	OEM	ROTOR ROTOR ROTORE DOIGT D'ALLUMEUR
REC3854311	850485 8504851 898253012 8M0062084 804424	Delco V6



REF	OEM	ROTOR ROTOR ROTORE DOIGT D'ALLUMEUR
REC3853801	392-9089 392-9767 392-9089T 392-9089Q FI6900186 FI6900190	Presolite V6 & V8



REF	OEM	ROTOR ROTOR ROTORE DOIGT D'ALLUMEUR
REC3854261	811636 8M6001254 8116361 898253011	Delco 4 cil. 3.0LX



REF	OEM	ROTOR ROTOR ROTORE DOIGT D'ALLUMEUR
REC3854549	8M6001253 808484 8084841 898253010	Delco V8 E. eléc.













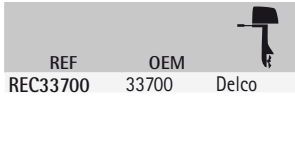

TRIGGERS (ROTOR + SENSOR)	TRIGGERS (ROTOR + SENSOR WHEEL)	TRIGGER (ROTORE + SENSORE)	KIT DOIGT D'ALLUMAGE
------------------------------	------------------------------------	-------------------------------	----------------------



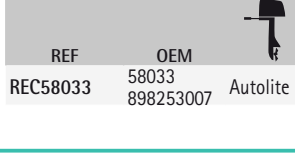



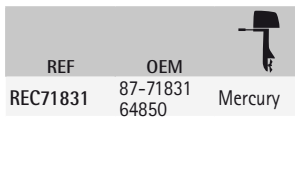



REF	OEM	TRIGGER TRIGGER TRIGGERS KIT DOIGT D'ALLUMAGE
REC13524A6	13524A6 13524Q06 13524A4 19405A4 90576A4	Merc. V6

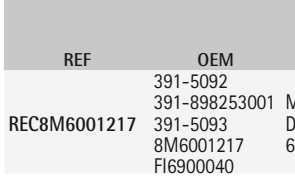

REF	OEM	TRIGGER TRIGGER TRIGGERS KIT DOIGT D'ALLUMAGE
REC13524A1	13524A1 13524T1 13524A5	Merc. V8

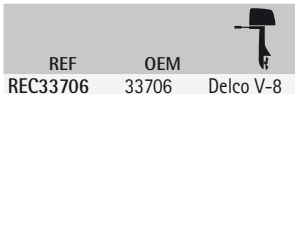

PLATINOS		POINTS	PUNTINE	VIS PLATINEES				
REF	OEM		REF	OEM				
REC8M6001219	392-898253005 392-6325 8M6001219 FI6900031	Prestolite	REC33700	33700	Delco			
REF	OEM		REF	OEM				
REC34235T	34235 34235T	Delco	REC58033	58033 898253007	Autolite			
REF	OEM		REF	OEM				
REC391-5090	391-5090 391-898253004 8M6001250	Mallory	REC71831	87-71831 64850	Mercury			

CONDENSADORES		CONDENSERS	CONDENSATORI	CONDENSATEUR				
REF	OEM		REF	OEM				
REC8M6001249	392-6324 392-898223002 8M6001249 FI6900023 FI6900032 FI6900083 FI6900189	Prestolite V8	REC8M6001217	391-5092 391-898253001 391-5093 8M6001217 FI6900040	Mallory V8, Delco 4 Et 6 Cil.			
REF	OEM		REF	OEM				
REC33662	33662 898253003 6325 898253005 33662Q 8M6001218 FI6900031	Delco 4 & 6 Cil.	REC33706	33706	Delco V-8			
REF	OEM		REF	OEM				
REC64851	81-64851 58034	Autolite						

KITS DE ENCENDIDO		TUNE UP KITS	KIT D'ACCENSIONE	KITS D'ALLUMAGE			
REF	OEM		REF	OEM			
REC3423A1	34235A1 34235Q1	Delco 4 & 6 cil.	REC391-5090Q1	391-5090A1 391-5090Q1	Mallory V8		

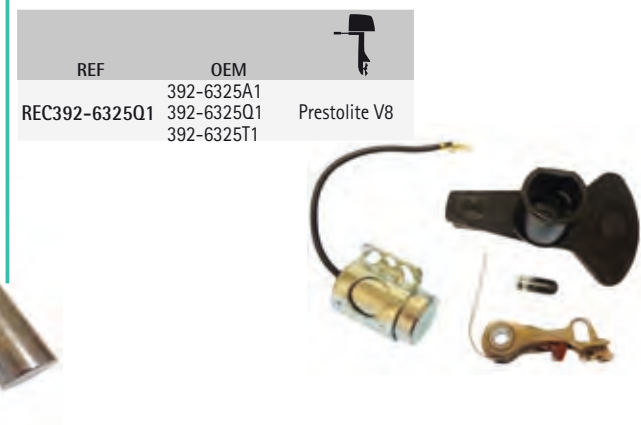
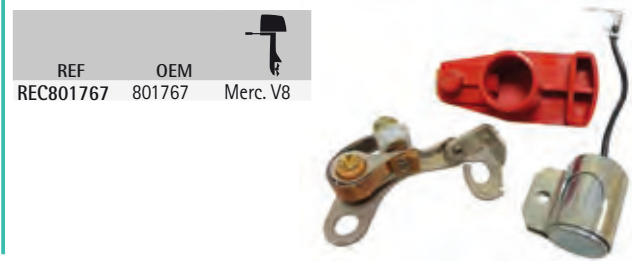
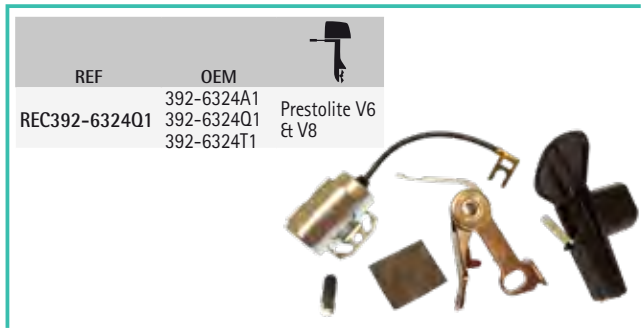

**GUÍA KITS DE ENCENDIDO IGNITION APPLICATION GUIDA KIT ACCENSIONE GUIDE KITS D'ALLUMAGE**

MOD.	CYL	AÑO YEAR ANNO ANNEE	SERIE SERIAL SERIE SERIE	ARRANQUE IGNITION ACCENSIONE ALLUMAGE	KIT	PLATINO POINT PUNTINE VIS PLATINÉES	CONDENSADOR CONDENSER CONDENSATORE CONDENSATEURS	ROTOR ROTOR ROTORE DOIGT D'ALLUM.
<b>L4</b>								
110	L-4	1963-66	1537370-2044033	Delco	REC3423A1	REC34235T	REC33662	REC1396-5238
120	L-4	1964-74	1666601-3825578	Delco	REC3423A1	REC34235T	REC33662	REC1396-5238
120/2.5L	L-4	1974-89	3825579-0C853255	Delco	REC3423A1	REC34235T	REC33662	REC1396-5238
140	L-4	1968-74	2508261-3826282	Delco	REC3423A1	REC34235T	REC33662	REC1396-5238
140/3.0L	L-4	1974-89	3826283-0C856558	Delco	REC3423A1	REC34235T	REC33662	REC1396-5238
3.0L/LX	L-4	1990-95	0C856559-0F603999	Prestolite	REC392-6324Q1	REC8M6001219	REC8M6001249	REC3853801
165/3.7L	L-4	1987-89	0B434940+	Delco	REC3423A1	REC34235T	REC33662	REC1396-5238
170	L-4	1985-86	6916779-0B434940	Delco	REC3423A1	REC34235T	REC33662	REC1396-5238
180/3.7LX	L-4	1987-89	0B436391+	Delco	REC3423A1	REC34235T	REC33662	REC1396-5238
180/3.7LX	L-4	1987-89	0B436391+	Prestolite	REC392-6324Q1	REC8M6001219	REC8M6001249	REC3853801
190	L-4	1985-86	6916779-0B436390	Delco	REC3423A1	REC34235T	REC33662	REC1396-5238
470	L-4	1976-84	4208730-691778	Delco	REC3423A1	REC34235T	REC33662	REC1396-5238
485	L-4	1980-82	5685394-6218036	Delco	REC3423A1	REC34235T	REC33662	REC1396-5238
488	L-4	1983-84	6170297-6916778	Delco	REC3423A1	REC34235T	REC33662	REC1396-5238
Prestolite	L-4				REC392-6324Q1	REC8M6001219	REC8M6001217	REC3853801
<b>L6</b>								
140	L-6	1963	1538930-1725960	Delco	REC3423A1	REC34235T	REC33662	REC1396-5238
150	L-6	1964-66	1666495-2048046	Delco	REC3423A1	REC34235T	REC33662	REC1396-5238
160	L-6	1967-69	2048022-2494926	Delco	REC3423A1	REC34235T	REC33662	REC1396-5238
160	L-6	1969	2494927-2770031	Delco	REC3423A1	REC34235T	REC33662	REC1396-5238
165	L-6	1971-81	2771484-5813433	Delco	REC3423A1	REC34235T	REC33662	REC1396-5238
165	L-6	1970	2770032-2771483	Delco	REC3423A1	REC34235T	REC33662	REC1396-5238
200	L-6	1969	2453769-2712072	Delco	REC3423A1	REC34235T	REC33662	REC1396-5238
Prestolite	L-6				REC392-6324Q1	REC8M6001219	REC8M6001249	REC3853801
V6								
185 (4 BBL.) (3.8L)	V-6	1983-84	6330183-6919655	Prestolite	REC392-6324Q1	REC8M6001219	REC8M6001249	REC3853801
<b>V8</b>								
190 (GM 283)	V-8	1963-64	1564539-1730903	Delco	REC801766			
215 MCM y MIE (Ford 302)	V-8	1970-72	2781153-3563181	Autolite	REC801768	REC3302-804844002	REC64851	REC65864
215 MCM y MIE (Ford 302)	V-8	1970-72	2781153-3562181	Mallory	REC391-5090Q1	REC391-5090	REC8M6001217	REC89825302
225 MCM y MIE	V-8	1973-74	3385721-4166999	Autolite	REC801768	REC3302-804844002	REC64851	REC65864
225 MCM y MIE	V-8	1973-74	3385721-4166999	Mallory	REC391-5090Q1	REC391-5090	REC8M6001217	REC89825302
225 MCM y MIE	V-8	1973-74	3385721-4166999	Mercury	REC801767	REC71831	REC64851	REC65864
888 (Ford 302)	V-8	1971-77	3108723-4887829	Mercury	REC801767	REC71831	REC8M6001217	REC65864
888 (Ford 302)	V-8	1971-77	3108723-4887829	Prestolite	REC392-6325Q1	REC8M6001219	REC8M6001249	REC834975
888 (Ford 302)	V-8	1971-77	3108723-4887829	Mallory	REC391-5090Q1	REC391-5090	REC8M6001217	REC89825302
888 (Ford 302)	V-8	1971-77	3108723-4887829	Autolite	REC801768	REC3302-804844002	REC64851	REC65864
225 (GM 327)	V-8	1963-69	1539620-2694014	Delco	REC801766			
228 MCM & MIE	V-8	1977-82	4765100-6218461	Mallory	REC391-5090Q1	REC391-5090	REC8M6001217	REC89825302
898/198 MCM & MIE	V-8	1977-82	4762210-6218461	Mallory	REC391-5090Q1	REC391-5090	REC8M6001217	REC89825302



MOD.	CYL	AÑO YEAR ANNEE	SERIE SERIAL SERIE	ARRANQUE IGNITION ACCENSIONE ALLUMAGE	KIT	PLATINO POINT PUNTINE VIS PLATINÉES	CONDENSADOR CONDENSER CONDENSATEUR CONDENSATEURS	ROTOR ROTOR ROTORE DOIGT D'ALLUM.
233 MCM & MIE	V-8	1975-77	4173000-4902304	Mercury	REC801767	REC71831	REC64851	REC65864
233 MCM & MIE	V-8	1975-77	4173000-4902304	Prestolite	REC392-6325Q1	REC8M6001219	REC8M6001249	REC834975
233 MCM & MIE	V-8	1975-77	4173000-4902304	Prestolite	REC392-6324Q1	REC8M6001219	REC8M6001249	REC3853801
250 (GM 350)	V-8	1977	4768000-4908849	Mallory	REC391-5090Q1	REC391-5090	REC8M6001217	REC89825302
255 MIE y MCM (Ford 351)	V-8	1973-80	3258728-5907057	Mallory	REC391-5090Q1	REC391-5090	REC8M6001217	REC89825302
255 MCM y MIE (Ford 351)	V-8	1973-80	3258728-5907057	Mercury	REC801767	REC71831	REC64851	REC65864
255 (GM 350)	V-8	1975-76	3258728-4501254	Mallory	REC391-5090Q1	REC391-5090	REC8M6001217	REC89825302
255 (GM 350)	V-8	1976	4498701-4767999	Mercury	REC801767	REC71831	REC64851	REC65864
260	V-8	1978-82	4908850-6128461	Mallory	REC391-5090Q1	REC391-5090	REC8M6001217	REC89825302
5.7L Ski	V-8	1985-95	0A338533-0F775199	Mallory	REC391-5090Q1	REC391-5090	REC8M6001217	REC89825302
5.7L Ski	V-8	1985-95	0A338533-0F775199	Prestolite	REC392-6324Q1	REC8M6001219	REC8M6001249	REC3853801
280 TRS	V-8	1975	4176250-4499390	Mercury	REC801767	REC71831	REC64851	REC65864
280 TRS	V-8	1976	4499391-4770199	Mallory	REC391-5090Q1	REC391-5090	REC8M6001217	REC89825302
330 MCM y MIE	V-8	1977-81	4623115-6083144	Mallory	REC391-5090Q1	REC391-5090	REC8M6001217	REC89825302
370 TRS	V-8	1978-85	4179554-6721527	Mallory	REC391-5090Q1	REC391-5090	REC8M6001217	REC89825302
370 TRS	V-8	1978-85	4883520-6721527	Holley	REC801767	REC71831	REC64851	REC65864
400 TRS	V-8	1980-86	5668232-0B457644	Mallory	REC391-5090Q1	REC391-5090	REC8M6001217	REC89825302
400 TRS	V-8	1980-86	5668232-0B457644	Holley	REC801767	REC71831	REC64851	REC65864
440 TRS	V-8	1983-86	6181070-0B485220	Mallory	REC391-5090Q1	REC391-5090	REC8M6001217	REC89825302
440 TRS	V-8	1983-86	6181070-0B485220	Holley	REC801767	REC71831	REC64851	REC65864
460 TRS	V-8	1983-86	6180970-6181046	Mallory	REC391-5090Q1	REC391-5090	REC8M6001217	REC89825302
460 TRS	V-8	1983-86	6180970-6181046	Holley	REC801767	REC71831	REC64851	REC65864

**KITS DE CONVERSIÓN  
ELECTRÓNICO**

Sustituyen condensadores y contactos por componentes electrónicos. Usa bobina, tapa y rotor estándar. Fácil instalación, una pieza y dos cables. Precisión entre 1/4" calibrado de 0 a 8000 rpm.

**ELECTRONIC  
CONVERSION KITS**

To substitute condensers for electronic devices. Uses standard coil, cap & rotor. Easy installation; one piece, two cables. Precisely calibrated between 1/4" from 0 to 8000.

**KIT DI CONVERSIONE  
ELETTRICO**

Sostituiscce condensatori e contatti per componenti elettronici. Utilizza bobina, calotta e rotore standard. Facile installazione, una pz e due cavi. Precisione 1/4" calibrato da 0 a 8000.

**KITS DE CONVERSION  
ÉLECTRONIQUE**

Remplace les condensateurs et les contacts par des composants électroniques. Utilisez une bobine, un couvercle et un rotor standard. Installation facile, une seule pièce et deux fils. Précision de 1/4" calibrée de 0 à 8000 rpm.

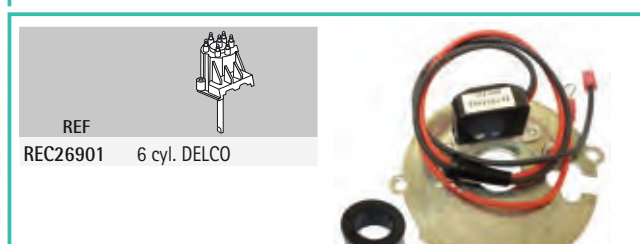

**GUÍA KITS DE CONVERSIÓN  
ELECTRÓNICO**

**ELECTRONIC CONVERSION  
KIT APPLICATION**

**GUIDA KIT CONVERSIONE  
ELETTRICO**

**GUIDE KITS DE CONVERSION  
ÉLECTRONIQUE**

MOD.	CYL	SERIE SERIAL SERIE	ARRANQUE IGNITION ACCENSIONE ALLUMAGE	KIT
470R	4	6218037	Delco	REC26900
485	4	5685394	Delco	REC26900
488R	4	6170297	Delco	REC26900
140	6	1538930 - 1725960	Delco	REC26901
150	6	1666495 - 2048046	Delco	REC26901
160	6	2048022 - 2770031	Delco	REC26901
165	6	2770032	Delco	REC26901
Alpha 1/120-140	6	6229718	Delco	REC26901
200	6	2453769 - 2712072	Delco	REC26901
198	8	4776402	Mallory YL670AV	REC26904
215	8	2781153	Mallory YL670AV	REC26904
225	8	3385721	Mallory YL670AV	REC26904
228	8	4765100 - 6218461	Mallory YL670AV	REC26904
233	8	4173000	Prestolite	REC26905

MOD.	CYL	SERIE SERIAL SERIE	ARRANQUE IGNITION ACCENSIONE ALLUMAGE	KIT
233	8	4173000	Prestolite (tornillo   screw   vite   vis)	REC26905
198	8	4776402	Mallory	YL670AV REC26904
250	8	4768000 - 4908849	Mallory	YL670AV REC26904
255	8	3258728	Mallory	YL670AV REC26904
260	8	4908850 - 6218461	Mallory	YL670AV REC26904
260	8	A338553+	Mallory	YL670AV REC26904
280	8	4499391	Mallory	YL670AV REC26904
330	8	4623115	Mallory	YL670AV REC26904
370, 400, 440, 460TRS	8	4179554	Mallory	YL670AV REC26904
888	8	3108723	Mallory	YL670AV REC26904
888	8	3108723	Prestolite	REC26905
888	8	4762210 - 6218461	Mallory	YL670AV REC26904
5.7	8	85B14627+	Ski Mallory	YL670AV REC26904



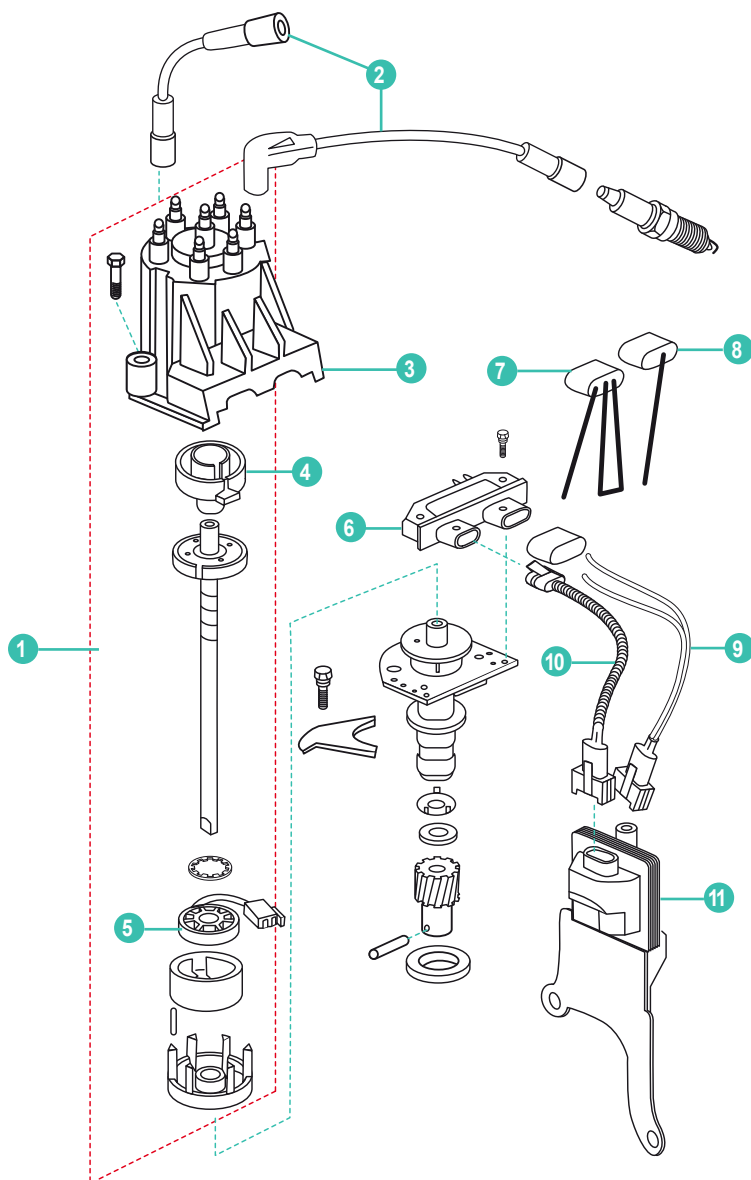

REF	OEM				
REC817377	817377	DISTRIBUIDOR 4 CYL	DISTRIBUTOR 4 CYL	DISTRIBUTORE 4 CYL	DISTRIBUTEUR 4 CYL
<b>1</b> REC807964A1	807964A1	DISTRIBUIDOR 6 CYL	DISTRIBUTOR 6 CYL	DISTRIBUTORE 6 CYL	DISTRIBUTEUR 6 CYL
REC805222A1	805222A1	DISTRIBUIDOR 8 CYL	DISTRIBUTOR 8 CYL	DISTRIBUTORE 8 CYL	DISTRIBUTEUR 8 CYL
REC15-405	84-816761Q13	KIT CABLE ARRANQUE: 3.0L	IGNITION WIRE SET: 3.0L	KIT CAVI INIEZIONE: 3.0L	KIT CÂBLE ALLUMAGE 3.0L
<b>2</b> REC15-601	84-816761Q16	KIT CABLE ARRANQUE: V6	IGNITION WIRE SET: V6	KIT CAVI INIEZIONE: V6	KIT CÂBLE ALLUMAGE V6
REC15-804	84-816761Q17	KIT CABLE ARRANQUE: V8	IGNITION WIRE SET: V8	KIT CAVI INIEZIONE: V8	KIT CÂBLE ALLUMAGE V8
REC3854260	3854260	TAPA 4 CYL	CAP 4 CYL	COPERCHIO 4 CYL	COUVERCLE 4 CYL
<b>3</b> REC3854331	3854331	TAPA 6 CYL	CAP 6 CYL	COPERCHIO 6 CYL	COUVERCLE 6 CYL
REC3854548	3854548	TAPA 8 CYL	CAP 8 CYL	COPERCHIO 8 CYL	COUVERCLE 8 CYL
REC3854311	850485	ROTOR V6	ROTOR V6	ROTORE V6	DOIGT D'ALLUMAGE V6
<b>4</b> REC3854549	8M6001253	ROTOR V8	ROTOR: V8	ROTORE: V8	DOIGT D'ALLUMAGE V8
REC3854261	8M6001254	ROTOR 4 CYL	ROTOR 4 CUL	ROTORE 4 CYL	DOIGT D'ALLUMAGE 4 CYL
<b>5</b> REC3854001	811639T	MÓDULO IMPULSOS	MODULE	MODULO	MODULE
<b>6</b> REC3854003	811637001	MÓDULO DISTRIBUIDOR	MODULE: DISTRIBUTOR	MODULO DISTRIBUZIONE	MODULE DISTRIBUTEUR
<b>7</b> REC91-888863	91-888863	HERRAMIENTA DISTRIBUIDOR	TOOL: TIMING	STRUMENTO DISTRIBUZIONE	TIMING JUMPER ALLUMAGE
<b>8</b> REC294005		CABLE: INTERRUPTOR	WIRE: SHIFT INTERRUPTER	CAVO: INTERRUPTORE	FAISCEAU POUR SHIFT INTERRUPTEUR
<b>9</b> REC500442		CABLE: BOBINA	WIRE LEAD: COIL HARNESS	CAVO BOBINA	FAISCEAU POUR BOBINE
<b>10</b> REC84-817376T01	84-817376T01	CABLE: DISTRIBUIDOR - BOBINA	WIRE LEAD: DISTRIBUTOR - COIL	CAVO: DISTRIBUZIONE - BOBINA	FAISCEAU DISTRIBUTEUR - BOBINE
<b>11</b> REC3854002	898253T27	BOBINA ARRANQUE	COIL: IGNITION	BOBINA INIEZIONE	BOBINE D'ALLUMAGE

THUNDERBOLT IV & V

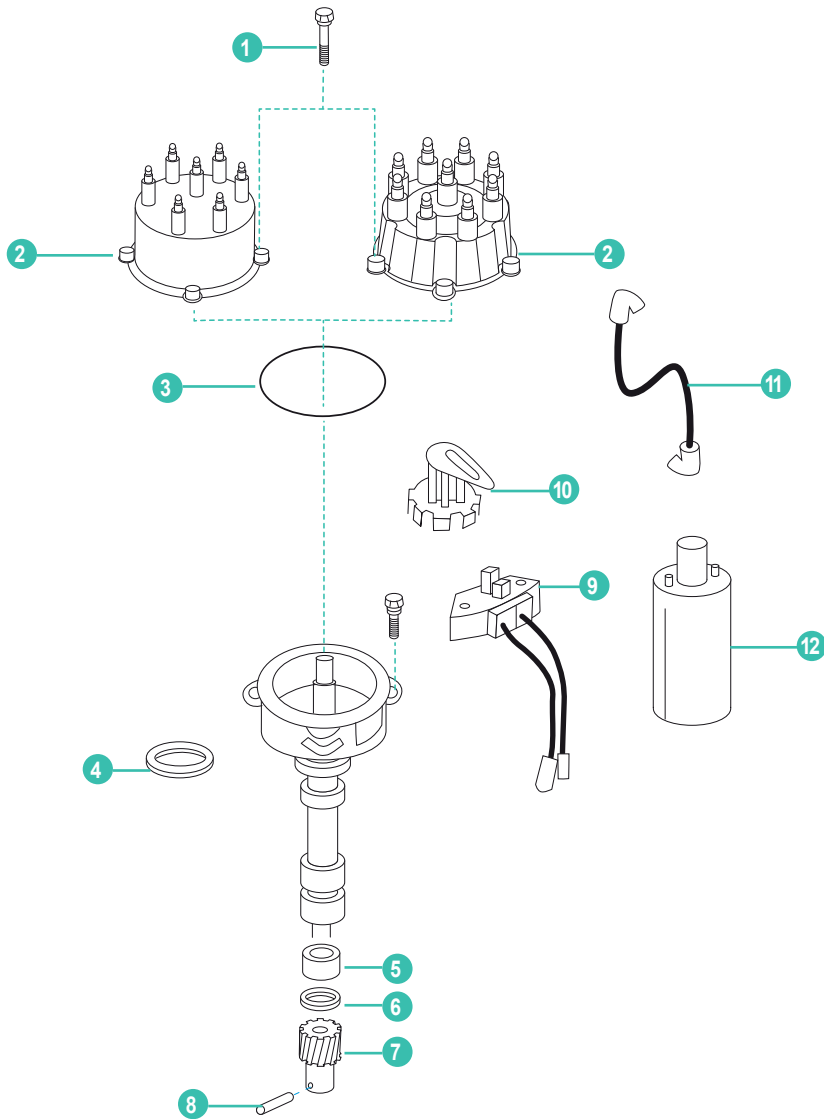

REF	OEM				
REC805185A3	805185A37	DISTRIBUIDOR V6 CON TERMINAL	DISTRIBUTOR ASSY. V6 W/BULLET	SPINTEROGENO V6 CON TERMINALI	DISTRIBUTEUR V6 AVEC TERMINAL
REC805185A36	805185A36	DISTRIBUIDOR V8 CON TERMINAL	DISTRIBUTOR ASSY. V8 W/BULLET	SPINTEROGENO V8 CON TERMINALI	DISTRIBUTEUR V8 VEC TERMINAL
1 REC10-90926	10-90926	TORNILLO	SCREW	VITE	VIS
2 REC815407A2	815407Q02	TAPA DISTRIBUIDOR V6	DISTRIBUTOR CAP V6	CALOTTA V6	TÊTE D'ALLUMEUR V6
REC805759Q01	805759Q01	TAPA DISTRIBUIDOR V8	DISTRIBUTOR CAP V8	CALOTTA V6	TÊTE D'ALLUMEUR V8
3 REC27-805760	27-805760	JUNTA	GASKET	GUARNIZIONE	JOINT
4 REC27-344861	27-34486-3	JUNTA	GASKET	GUARNIZIONE	JOINT
5 REC23-90915	23-90915	CASQUILLO	BUSHING	BOCCOLA	BAGUE
6 REC12-90931	12-90931	ARANDELA	WASHER	RONDELLA	RONDELLE
7 REC43-818807	43-818807	PIÑÓN DELCO	DRIVE GEAR	PIGNONE DELCO	PIGNON D'ALLUMEUR
8 REC17-47617	17-47617	PASADOR	PIN	CHIAVISTELLO	PIN
9 REC87-892150Q02	87-892150Q02	MÓDULO DISTRIBUIDOR	SENSOR ASSEMBLY	MODULO SPINTEROGENO	MODULE DISTRIBUTEUR
10 REC13524A6	13524Q06	ROTOR V6	ROTOR ASSEMBLY V6	ROTORE V6	DOIGT D'ALLUMAGE V6
REC13524A1	13524T1	ROTOR V8	ROTOR ASSEMBLY V8	ROTORE V8	DOIGT D'ALLUMAGE V8
11 REC15-601	84-816761Q16	KIT CABLES BUJÍAS V6	WIRES KIT V6	KIT CAVI V6	FAISCEAU BOUGIES V6
REC15-804	84-816761Q17	KIT CABLES BUJÍAS V8	WIRES KIT V8	KIT CAVI V8	FAISCEAU BOUGIES V8
12 REC300-00879	392-805570A2	BOBINA	COIL	BOBINA	BOBINE

## MPI V6 & V8

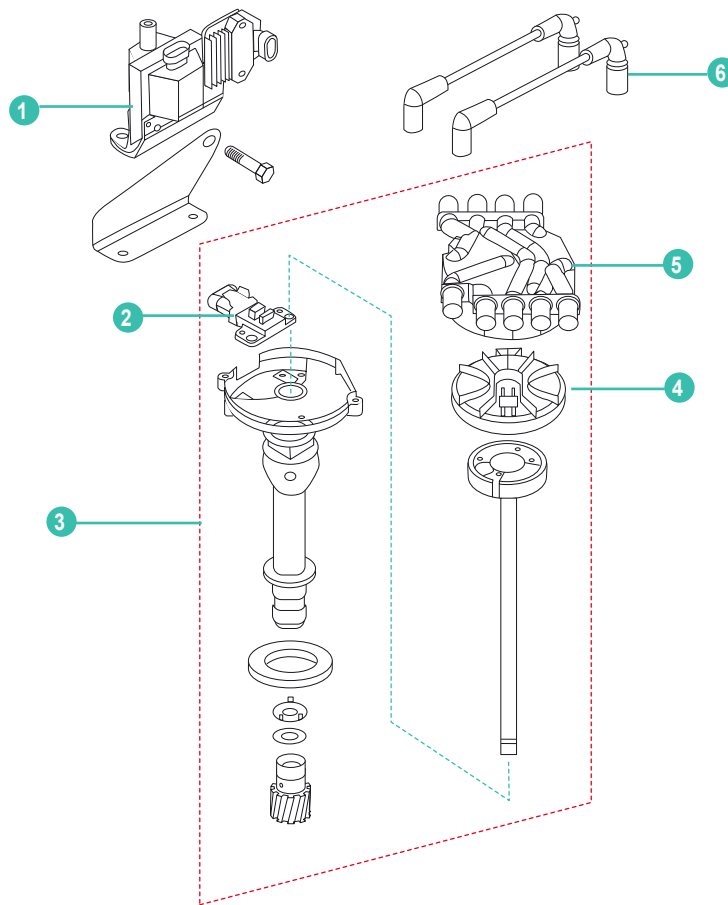



	REF	OEM				
1	REC3861985	392-8M0054588	BOBINA ENCENDIDO	IGNITION COIL	BOBINA INIEZIONE	BOBINE D'ALLUMAGE
2	REC3863130	898141	SENSOR POSICIÓN ÁRBOL DE LEVAS	DISTRIBUTOR PICK-UP	SENSORE POSIZIONE ALBERO A CAMME	SONDE POSITION ARBRE A CAMES
3	REC40005334	888751A03	DISTRIBUIDOR V6	DISTRIBUTOR V6	DISTRIBUTORE V6	DISTRIBUTEUR V6
	REC21622232	879150A87	DISTRIBUIDOR V8	DISTRIBUTOR V8	DISTRIBUTORE V8	DISTRIBUTEUR V8
4	REC898253013	8M6001222	ROTOR	ROTOR	ROTORE	DOIGT D'ALLUMAGE
5	REC898253T23	898253T23	TAPA V6	CAP V6	COPERCHIO V6	COUVERCLE V6
	REC898253T22	898253T22	TAPA V8	CAP V8	COPERCHIO V8	COUVERCLE V8
	REC15-606	84-863656A2	KIT CABLES V6	WIRES KIT V6	KIT CAVI V6	FAISCEAU V6
6	REC15-815	84-816608A1	KIT CABLES V8 (5.0L, 5.7L)	WIRES KIT V8 (5.0L, 5.7L)	KIT CAVI V8 (5.0L, 5.7L)	FAISCEAU V8 (5.0, 5.7L)
	REC15-813	84-863656A1	KIT CABLES V8 (6.2L)	WIRES KIT V8 (6.2L)	KIT CAVI V8 (6.2L)	FAISCEAU V8 (6.2L)

### DISTRIBUIDOR

### DISTRIBUTOR

### SPINTEROGENO

### DISTRIBUTEUR

REF	OEM		
REC40005334	888751A03 88751A02 888751A1	Vortec V6 4.3l MPI (2002+) (OM3000000+)	REC15-606





REF	OEM		
REC17177A1	17177A1 91823A3 816148A1 74905A3 68521A4 68521A3 13447A1	GM V8. (Small & large block) MALLORY YL 624 AV	REC15-801





REF	OEM		
REC21622232	884794A02 879150A87 884794A1	Vortec V8 2001+ 5.0L, 5.7L, 6.2L MPI (OM300000 +)	REC15-815





REF	OEM		
REC392-6316	392-6316	FORD 302 CID V8 MALLORY YL512CV	REC15-801



REF	OEM		
REC195141	87581T 195141 87581 62424 58231 52352 33266	GM 4 CIL. (120 & 140) MALLORY YL673AV	REC15-401



REF	OEM		
REC392-6330	392-6330	FORD 351 CID V8 MALLORY YL554CV	REC15-801

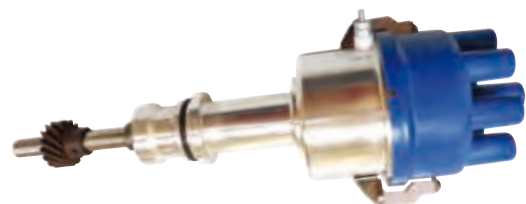

**DISTRIBUIDOR ELECTRONICO**      **ELECTRONIC DISTRIBUTOR**



**SPINTEROGENO ELETTRICO**      **DISTRIBUTEUR ELECTRONIQUE**

REF	OEM		
REC805185A3	805185A3	Vortec V6 4.3I MPI 20A V6. HEI Modernos   Late   Moderno   Modernes	REC15-604







REF	OEM		
REC805185A36	805185A36	V8. (HEI Modernos   Late   Moderno   Modernes)	REC15-801





REF	OEM		
REC817377	817377 817377T	181 RX (LX - MPI) Delco est ignition	REC15-405



REF	OEM			
REC805222A1	805222A1	V8 (EFI - TBI - MPI) 262-454 & 452	384 / 409	REC15-804









REF	OEM		
REC807964A1	807964A1 907964A1	V6 (EFI - TBI)	REC15-601



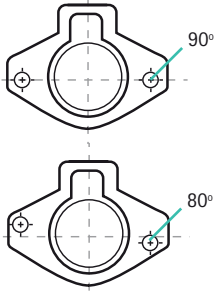

# SISTEMA DE REFRIGERACIÓN COOLING SYSTEM

# SISTEMA DI RAFFREDDAMENTO SYSTÈME DE REFROIDISSEMENT

TERMOSTATO	THERMOSTAT	TERMOSTATO	THERMOSTAT									
<b>KIT CUERPO DE TERMOSTATO</b>	<b>THERMOSTAT HOUSINGS KIT</b>	<b>KIT CORPO TERMOSTATO</b>	<b>KIT CORPS DE THERMOSTAT</b>									
<table border="1"> <thead> <tr> <th>REF</th> <th>OEM</th> <th></th> </tr> </thead> <tbody> <tr> <td>REC87290A23</td> <td>87290A26</td> <td>V6 &amp; V8 BLOQUE PEQUEÑO SMALL BLOCKS BLOCCO PICCOLO BLOQUE PETIT</td> </tr> <tr> <td>REC90736A24</td> <td>90736A24</td> <td>V6 &amp; V8 BLOQUE GRANDE BIG BLOCKS BLOCCO GRANDE BLOQUE GRAND</td> </tr> </tbody> </table>	REF	OEM		REC87290A23	87290A26	V6 & V8 BLOQUE PEQUEÑO SMALL BLOCKS BLOCCO PICCOLO BLOQUE PETIT	REC90736A24	90736A24	V6 & V8 BLOQUE GRANDE BIG BLOCKS BLOCCO GRANDE BLOQUE GRAND			
REF	OEM											
REC87290A23	87290A26	V6 & V8 BLOQUE PEQUEÑO SMALL BLOCKS BLOCCO PICCOLO BLOQUE PETIT										
REC90736A24	90736A24	V6 & V8 BLOQUE GRANDE BIG BLOCKS BLOCCO GRANDE BLOQUE GRAND										
 <p>NOTA: reemplaza a este cuerpo NOTE: replaces this housing NOTA: sostituisce questo modello REMARQUE : remplace ce corps</p>												

CUERPOS TERMOSTATO	THERMOSTATO HOUSING	CORPO TERMOSTATO	CORPS DE THERMOSTAT												
<table border="1"> <thead> <tr> <th>REF</th> <th>OEM</th> <th></th> </tr> </thead> <tbody> <tr> <td>BAMC29-47587</td> <td>861493A07 47587A2 47587 861493A3</td> <td>GM 153, 181, 250, 292, 120, 140, 2.5L, 3.0, 3.0LX (4 cyl) (1964-97) 160, 165, 200 (6 cyl) (1967-81)</td> </tr> </tbody> </table>	REF	OEM		BAMC29-47587	861493A07 47587A2 47587 861493A3	GM 153, 181, 250, 292, 120, 140, 2.5L, 3.0, 3.0LX (4 cyl) (1964-97) 160, 165, 200 (6 cyl) (1967-81)		<table border="1"> <thead> <tr> <th>REF</th> <th>OEM</th> <th></th> </tr> </thead> <tbody> <tr> <td>REC78984A08</td> <td>78984A08 78984A1</td> <td>198 MIE (2 bbl) GM 305 V8 (1977) 228, 228 MIE (4 bbl) GM 305 V8 (1977-80) 225 MIE GM 350 V-8 (1979-80) 260 (4 bbl) GM 350 V-8 (1978-82) 898 (2 bbl) GM 350 V-8 (1977-82)</td> </tr> </tbody> </table>	REF	OEM		REC78984A08	78984A08 78984A1	198 MIE (2 bbl) GM 305 V8 (1977) 228, 228 MIE (4 bbl) GM 305 V8 (1977-80) 225 MIE GM 350 V-8 (1979-80) 260 (4 bbl) GM 350 V-8 (1978-82) 898 (2 bbl) GM 350 V-8 (1977-82)	
REF	OEM														
BAMC29-47587	861493A07 47587A2 47587 861493A3	GM 153, 181, 250, 292, 120, 140, 2.5L, 3.0, 3.0LX (4 cyl) (1964-97) 160, 165, 200 (6 cyl) (1967-81)													
REF	OEM														
REC78984A08	78984A08 78984A1	198 MIE (2 bbl) GM 305 V8 (1977) 228, 228 MIE (4 bbl) GM 305 V8 (1977-80) 225 MIE GM 350 V-8 (1979-80) 260 (4 bbl) GM 350 V-8 (1978-82) 898 (2 bbl) GM 350 V-8 (1977-82)													

REF	OEM	
REC87290A4	87290A4	4.3L V6 (1983-92) 5.0 & 5.7L V8 (1981-95) Race sterndrive GM454, 502 & 540 (1986-96)

REF	OEM	
BAMC29-78985	78985A1	330 GM454 V8 (1977-81)

REF	OEM	
RM863457A2	863457A2	4.3L, 350 MAG, 5.0L, 6.2L (MPI & MX)

Todos los motores de inyección con 1 o 3 puntos de drenaje.  
All Injection with 1 or 3 point drain system.  
Tutti i motori ad iniezione con 1 o 3 punti di drenaggio.  
Tous les moteurs à injection avec 1 ou 3 points de vidange.

REF	OEM	
REC55131A5	55131A5	V6 & V8 con circuito de agua cerrado. with raw water cooling system. con circuito di acqua chiuso. avec circuit d'eau fermé.

REF	OEM	
BAMC29-63588	889333 63588A1	FORD V8 302 (1971-77) 351 (1973-77)

**ACERO INOXIDABLE**

Con cola Bravo. Incluye kit de casquillos para adaptarse a cualquier colector.

**STAINLESS STEEL**

With Bravo sterndrive. Includes bushing kit to fit any manifold.

**ACCIAIO INOX**

Con piede Bravo. Il kit include boccole per adattarsi a qualsiasi collettore.

**ACIER INOXYDABLE**

Avec l'embase Bravo. Comprend un kit de bagues pour s'adapter à n'importe quel collecteur.

REF	OEM	
REC8M0061381	861006A1 8M0061381 860256A4	GM V6 & V8 (305, 350, 357, 383) 4.3, 5.0, 5.7, 6.2L 7.4 & 8.2L (1998+)



**CASQUILLO TERMOSTATO**

**THERMOSTAT SLEEVE**

**BOCCOLA TERMOSTATO**

**CALE DE THERMOSTAT**

REF	OEM	
REC23-806922	23-806922	Para la mayoría de 3.0L, V6, V8 Fits most 3.0L, V6, V8 Si adatta maggiormente 3.0L, V6, V8 Pour la plupart des 3.0L, V6, V8



VÁLVULA "T" TERMOSTATO	TEE VALVE ASSY	VALVOLA "T" TERMOSTATO	TE VALVE THERMOSTAT
------------------------	----------------	------------------------	---------------------

REF	OEM		CUERPO DE TERMOSTATO THERMOSTAT HOUSING CORPO TERMOSTATO CORPS THERMOSTAT
REC22-98477A2	22-98477A2	GM V6 & V8	REC87290A4



EJE VÁLVULA TERMOSTATO	CHECK BALL KIT	ASSE VALVOLA TERMOSTATO	AXE VALVE THERMOSTATIQUE
------------------------	----------------	-------------------------	--------------------------

REF	OEM		MCM R/MR/ALPHA ONE (1983-90)
REC30-98475T1	30-98475T1		



MÓDULO DISTRIBUCIÓN DE AGUA	WATER DISTRIBUTION MODULE	MODULO DISTRIBUZIONE ACQUA	MODULE DE DISTRIBUTION D'EAU
-----------------------------	---------------------------	----------------------------	------------------------------

REF	OEM		GM 4.3, 5.0, 5.7 & 6.2L (MPI)
RM863631T1	863631T1		

Drenaje manual  
Manual drain  
Drenaggio manuale  
Drainage manuel

REF	OEM		GM 4.3, 5.0, 5.7 & 6.2L (MPI)
RM863444T1	863444T1		

Varilla accionada  
Rod actuated  
Asta azionata  
Tige motrice

REF	OEM		V6 & V8 AIR ACTUATED DRAIN
REC863802T2	863802T2		

*new*

CONECTOR RÁPIDO	FITTING	CONNETTORE	RACCORD VIDANGE
-----------------	---------	------------	-----------------

REF	OEM		4 CYL INLINE V6 & V8
REC22-862225	22-862225		

*new*

CUBIERTAS TERMOSTATO THERMOSTATO COVER

REF	OEM	CUERPO HOUSING CORPO CORPS	
BAMC29-60372	60372A1 60372A2 861493A07	BAMC29-47587	4 Et 6 cyl inline



COPERCHIO TERMOSTATO COUVERCLE DE THERMOSTAT

REF	OEM	CUERPO HOUSING CORPO CORPS	
REC8M0061068	47442A1	BAMC29-78985	454, 502, V8 BIG BLOCK



REF	OEM	CUERPO HOUSING CORPO CORPS		
BAMC29-62898	62898A1 62898	BAMC29-63588		Con colas With sterndrive Con Piede Avec embases
BAMC29-59498	59498 59498A1	BAMC29-63588		Con Eje With Shaft Con asse Avec arbre



REF	OEM	CUERPO HOUSING CORPO CORPS	
REC47441A1	47441A1	REC87290A4	262 V6 / 305, 350 V8 SMALL BLOCK



JUNTAS TERMOSTATO

THERMOSTATO GASKETS

GUARNIZIONI TERMOSTATO

JOINTS DE THERMOSTAT

REF	OEM	CASQUILLO SLEEVE BOCCOLA BAGUE
REC25-30224	25-30224	REC23-806922
REC27-47510Q	27-47510Q	REC23-47508T



REC25-30224



REC27-47510Q

CUERPO TERMOSTATO --> CULATA

THERM. HOUSING --> CYLINDER HEAD

CORPO TERMOSTATO --> TESTATA

CORPS THERMOSTAT --> TÊTE MOTEUR

REF	OEM	CUERPO HOUSING CORPO CORPS	
REC27-8146801	27-8146801	BAMC29-47587	4 Et 6 cyl inline



JUNTA TAPA --> CUERPO TERM.

COVER --> THERMOSTAT HOUSING

COPERCHIO --> CORPO TERM.

JOINT COUVERCLE --> CORPS THERM.

REF	OEM
REC27-33179Q02	27-33179Q02



REF	OEM
REC17494A1	17494A1

Tapa y junta  
Cover Et gasket  
Coperchio e guarnizione  
couvercle et joint



DEPOSITO --> CUERPO TERM.

TANK --> THERMOSTAT HOUSING

SERBATOIO --> CORPO TERM.

DEPOSIT --> CORPS THERM.

REF	OEM	
REC27-74830	27-74830	MCM 470 3.7L (1976-82)





BY-PASS --> TERMOSTATO      BY-PASS --> THERMOSTAT HOUSING      BY-PASS --> TERMOSTATO      BY-PASS --> THERMOSTAT

REF	OEM	
REC27-41812Q	27-41812Q 27-41812	GM V6 / V8 SMALL BLOCK
REC27-418122	27-418122	GM 454 / 502 V8 BIG BLOCK
REC27-48818Q01	27-48818Q01	GM V8, SMALL & BIG BLOCK
REC27-475901	27-47590-1	4 & 6 cyl inline
REC27-60208Q	27-60208	Ford 302 / 351

REC27-41812Q      REC27-418122      REC27-48818Q01

REC27-475901      REC27-60208Q

CUERPO TERM. --> COL. ADMISIÓN      THERM. HOUSING --> INTAKE MANIFOLD      CORPO TERM. --> COL. ASPIRAZIONE      CORPS THERM. --> COL. ADMISION

REF	OEM	
REC27-53045Q01	27-53045Q01 53051	GM V6 & V8
REC27-33918	27-8M2021920	GM 4 & 6 cyl inline
REC27-54506	27-5450	FORD 302/351
REC27-89656-1	27-89656-1	MCM 470 3,7 L (1976-82)

REC27-53045Q01      REC27-33918      REC27-54506      REC27-89656-1

**D DIESEL**      TERMOSTATO      THERMOSTATO      TERMOSTATO      THERMOSTAT

REF	OEM	
REC8M0093561	8M0093561 879194215 879194233 879194231 896332148	CMD 2,8 / 4.2

new

REF	OEM	
REC8M0093480	8M0093480 8M0067292 8M0066646	TDI 3.0L

new

**GAS**      KITS TERMOSTATO      THERMOSTATO KIT      KIT TERMOSTATO      KITS THERMOSTAT

REF	OEM		°C
REC59078Q3	59078Q3	4 & 6 CYL INLINE	60°

REF	OEM		°C
REC864493	864493	4.3L CARB ALPHA / BRAVO 4.3L MPI ALPHA / BRAVO 4.5L MPI (FRESH WATER) 350 MAG MPI ALPHA / BRAVO 357 HRZ 377 MAG MPI 5.0L MPI ALPHA / BRAVO 5.7L MPI 6.2L MPI	80°

REF	OEM		°C
REC8M0091470	807252T2 8M0091470	GM V6 Et V8, 181° Modelos modernos Late models Modelli moderni Modèles modernes	70°



REF	OEM		°C
REC99155T2	99155T2	4 cyl 224 (3.7L)	70°

Motores con colector escape de aluminio y circuito de refrigeración cerrado.  
Engines with closed cooling & aluminum exhaust manifold  
Motori con circuito di refrigerazione chiuso e colettore di scarico in alluminio  
Moteurs avec collecteur d'échappement en aluminium et circuit de refroidissement fermé.





REF	OEM		°C
REC807252Q5	807252Q5	GM V6 Et V8° Modelos modernos Late models Modelli moderni Modèles modernes	70°



REF	OEM		°C
REC8M0089715	807252T1 8M0089715	GM V6 Et V8, Ford V8 4.5L MPI (RAW WATER) 6.2L MPI (RAW WATER)	60°



REF	OEM		°C
REC807252Q3	807252Q3	FORD V8	60°



REF	OEM		°C
REC807252Q4	807252Q4 807252T4	GM V6 Et V8 4.5L MPI (RAW WATER) 6.2L MPI (RAW WATER)	60°



# INTERCAMBIADOR DE CALOR

# HEAT EXCHANGER

# SCAMBIATORE DI CALORE

# ÉCHANGEUR DE CHALEUR

Para saber cual es la ref. que comprende a su motor, informar del modelo de motor y nº de serie

To know which is the model you need, please inform the model and serial number of the engine.

Per sapere il modello corretto, fornire all'assistenza clienti il numero di serie del motore.

Pour savoir quelle est la référence de votre moteur, veuillez indiquer le modèle et le numéro de série du moteur.

REF	OEM
RM99438A1	99438A1



## KITS INTERCAMBIADOR

## HEAT EXCHANGER KITS

## KIT SCAMBIATORI

## KITS ÉCHANGEUR

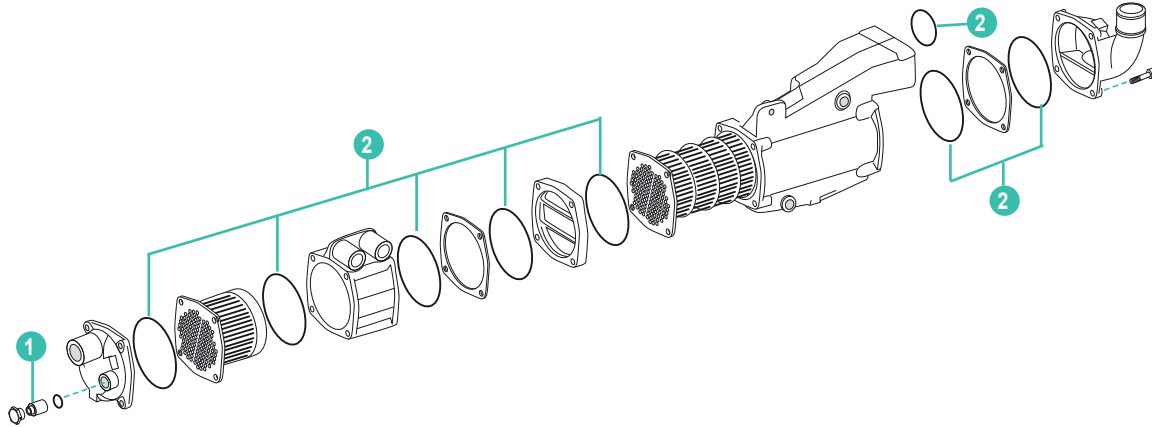

2	OEM	new
REC32126	25-896332126 25-89633	CMD, CMQSD 2.8 CMQSD4.2

1	OEM
TEN01320T	

3	OEM	new
REC25-8M0084884	8M0084884 25-8M0039163 25-8071341 25-26802	4.5L MPI, 4.3 MPI 350 MPI / 5.0L MPI 383 MAG/MPI 6.2L MPI

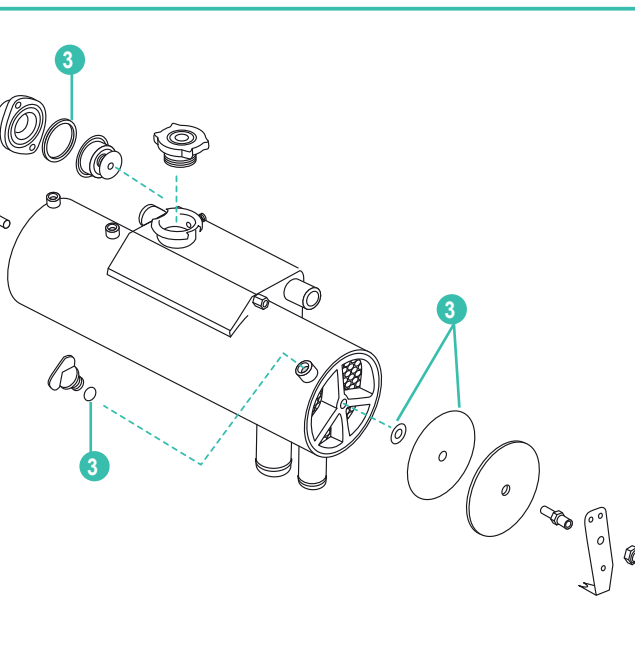

## ENFRIADOR DE ACEITE

## OIL COOLER

## RAFFREDDAMENTO DELL'OLIO

## REFROIDISSEUR D'HUILE

Para saber cual es la ref. que comprende a su motor, informar del modelo de motor y n° de serie

To know which is the model you need, please inform the model and serial number of the engine.

Per sapere il modello corretto, fornire all'assistenza clienti il numero di serie del motore.

Pour savoir quelle est la référence de votre moteur, veuillez indiquer le modèle et le numéro de série du moteur.

REF	OEM
RM807371T1	807371T1
REC99356A2	99356A2
RM99356A1	99356A1
REC89690T	89690T



### KITS ENFRIADOR DE ACEITE

### OIL COOLER KITS

### KIT GUARNIZIONE RAFFREDDAMENTO OLIO

### KIT JOINT REFROIDISSEUR D'HUILE

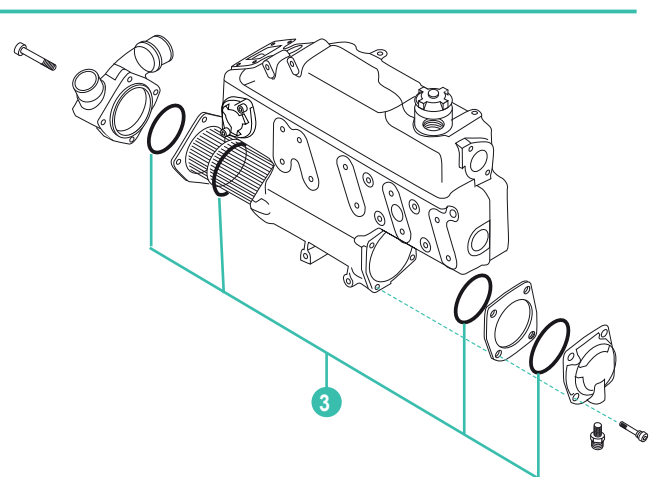
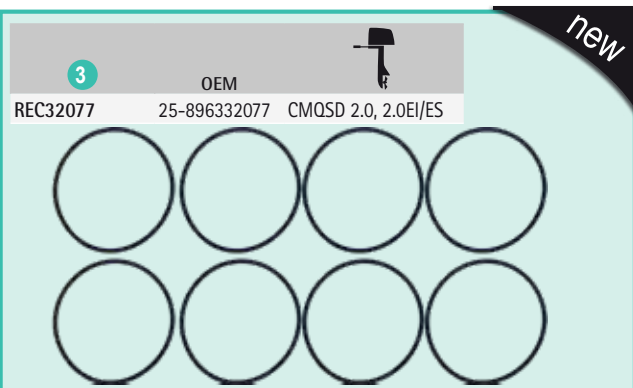
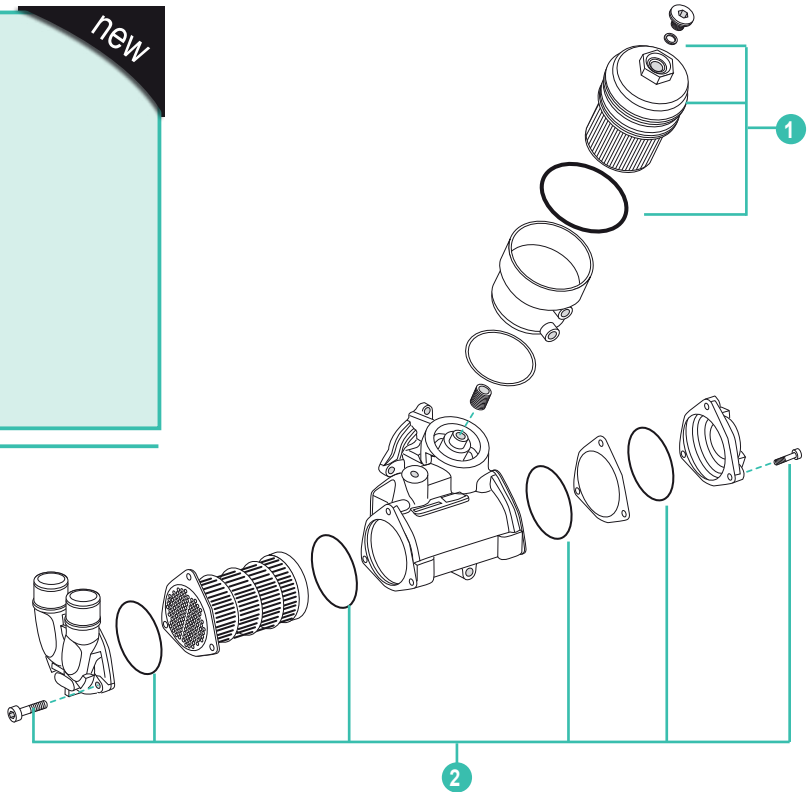
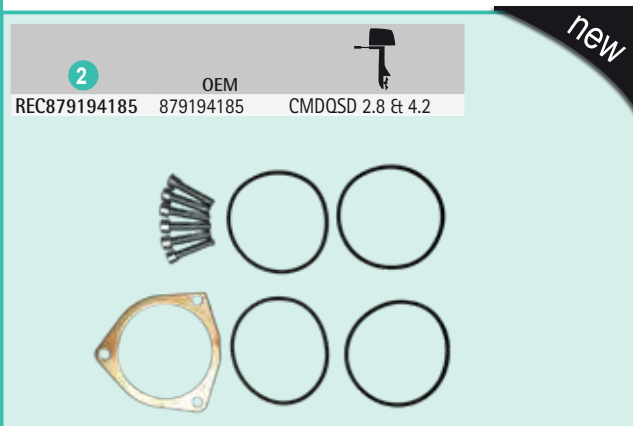



KITS BOTELLAS DE ACEITE RESERVOIR ASSY KITS

REF	OEM
RM806193A48	806193A48
	806193A38
	806193A20
	19742A1
	19742A3



KIT BOTTIGLIA OLIO

REF	OEM
REC22-861150T02	22-861150T02
	22-861150A1
	22-861150A2
<hr/>	
REF	OEM
RM22-861163	22-861163
<hr/>	
REF	OEM
RM53-87843	53-87843



KIT RESERVOIR D'HUILE

BOMBAS DE AGUA

WATER PUMPS

POMPE ACQUA

POMPE D'EAU

BOMBAS DE AGUA

WATER PUMPS

POMPE ACQUA

POMPE D'EAU

REF	OEM	
REC46-8M0113733	884727 8M0113733	GM 4 Et 6 CYL INLINE





REF	OEM	
REC879194401	46-879194401 8M0094406 8M6005225	V6 (2007+) (Sin bypass   without water bypass hole   senza bypass   sans bypass) MCM MPI (OW658583+) MCM Carb. (1A063240+)



REF	OEM	
REC46-8M0113734	8503991 8M0113734	GM 4 Et 6 CYGM V6 Et V8 SMALL BLOCK





REF	OEM		
RM46-807151A8	46-807151A8 46-72774A69	MerCruiser 454 Magnum 7.4 Et 502 Con acople bomba gasolina. Includes fuel pump adapter. Con accoppiamento pompa benzina. Avec accouplement de la pompe à carburant. GEN V Et VI (1992-99)	REC47-59362Q01





REF	OEM	
REC46-8M0113735	8504541	GM V8 BIG BLOCK





REF	OEM	
REC46-8M0113736	883925 8M0113736	GM 8.1L





REF	OEM	
REC3853796	883885	FORD V8 302,351





REF	OEM			KIT
SHEG155	806152	Mercruiser 7.3L Diesel 7.3L (BRAVO & MIE) DIESEL NAV 444 V-8 (1994-96) (OF060000+)	REC47-59362Q01	SHE15979





REF	OEM		
SHEG151	805835	7.3L (BRAVO & MIE) DIESEL NAV444 V-8 (1994-96) D7.3L D-TRONIC 260LD (1999) D 7.3L D-TRONIC 300 (1999)	SHE15000K



REF	OEM		
SHEG2603X	CUMMINS Diesel		SHE26000K



REF	OEM			PORTS
REC8M0155633	8M0155633 897345016 8M0129714	CUMMINS 4.2QSD (270,320,350) 3.0L VM V6 IB/SD (150, 230, 270)	REC15000K SHE15000K	39.75 mm





new

REF	OEM			PORTS
REC8M0148530	8M0148530 854179001	MERCURISER CUMMINS MARINE CMD 2.8 EI, ES (170/200)	REC10615K SHE10615K	40.5 mm
SHEP1016	879312023 8M0148530	CMD QSD 2.8 EI, ES (170/210/220/230) CMD QSD 2.0 EI, ES (115/130/150)		



new



<b>BOMBAS DE AGUA BRONCE CON TORNILLERIA DE INOX</b>	<b>WATER PUMPS BRASS WITH STAINLESS STEEL FITTINGS</b>	<b>POMPE ACQUA IN BRONZO CON VITERIA INOX.</b>	<b>POMPES À EAU BRONZE AVEC VIS EN ACIER INOXYDABLE</b>
--	--	--	---

REF	OEM				OEM
REC46-807151A9	46-807151A9	V6 & V8 con correa serpentin. with serpentine belt. con cinghia serpentina avec courroï serpentine	REC47-59362Q01	REC861579	861579 807731T



REF	OEM				OEM
REC46-862914T10	46-862914T10	4.3L MPI, 5.0L MPI, 350 MAG MPI Et MX, 8.2L MAG 6.2L MPI (ECM 555)	REC47-862232A2	REC862351T	862351T



REF	OEM			kit 
REC46-72774A32	46-807151A12 46-72774A32 46-59112A2 46-63450A2 46-72774A11 46-73823A7	V6 Et V8 con correa V. with V belt. con cinghia V avec courroie V	REC47-59362Q01	REC47-59362A4

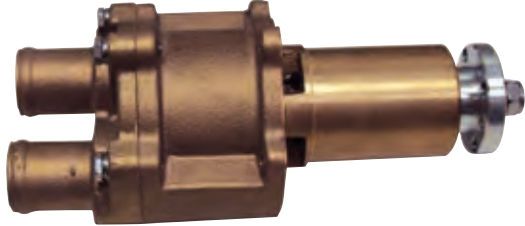



### JUNTAS BOMBAS DE AGUA

### WATER PUMPS GASKETS

### GUARNIZIONE POMPE DELL'ACQUA

### JOINTS DE POMPE D'EAU

REF	OEM		BOMBA PUMP POMPA POMPE
REC27-803192A2	24-803192A2	454-502 CHEVY	REC46-8M0113735



REF	OEM		BOMBA PUMP POMPA POMPE
REC27-34897	27-34897	GM V6 Et V8 (Bloque pequeño   Small block   blocco piccolo   Bloque petit)	REC879194401 REC46-8M0113734





REF	OEM		BOMBA PUMP POMPA POMPE
REC27-56880	27-56880	Ford V8 (302, 351)	REC3853796



REF	OEM		BOMBA PUMP POMPA POMPE
REC27-49110	27-49110	V-8 (Bloque grande   big block   blocco grande   bloque grand) 454-502 CHEVY	REC46-8M0113735



REF	OEM		BOMBA PUMP POMPA POMPE
REC27-33956	27-33956	4 Et 6 Cyl.	REC46-8M0113733



		OEM	SHERWOOD	CEF	JOHNSON	JABSCO	RECMAR	A (mm)	B (mm)	C (mm)
1	CUMMINS (SHERWOOD pump) G2601 Y G2603X. Núcleo estriado   Fluted core   Nucleo scanalato   Noyau strié.	3972366	SHE26000K	CEF500183G				20	94,5	79,8
2	DIESEL 7.3 L	47-853126 3349198 3916720	SHE15000K	CEF500167			REC15000K	16	65	51,2
3	MC-1/R/MR/ALPHA ONE	47-89984T4		CEF500313G			REC47-89984T4	22,3	60	33,8
4	ALPHA GENE II	47-43026Q02		CEF500301			REC47-43026Q02	22,4	89	32,5
5	530DTA, 636DTA, D219, D183, D281, D4.2L	47-801332602		CEF500106GT	JOH09-1028B		REC3841697	14,29	65	50,2
6	BRAVO (inyección   injection   iniezione   injection)	47-862232A2 47-8M0104229		CEF500159G			REC47-862232A2	11,4	66,5	50,6
7	HINO DIESEL	47-809866T 47-831311350		CEF500161			REC47-809866T	14,29	65	68,2
8	D254, D3.6L, D4.2L	47-816814T		CEF500177GT		JAB17018-0001	REC3593573	14,29	65,2	75,65
9	BRAVO	47-59362Q01		CEF500109			REC47-59362Q01	16,85	66,5	50,6
10	CMD QSD 2.0 & 2.8 SHERWOOD PUMP	47-879312025	SHE10615K	CEF500120T			REC10615K	15,9	65,2	41,3
11	CMD QSD 2.0 & 2.8 JABSCO PUMP	47-896332063		CEF500155		JAB11979-0001	REC11979-0001	14,29	58,65	36,65
12	CMD QSD 4.2 JABSCO PUMP	47-879194186		CEF500114T		JAB17937-0001-P	REC17937-0001	14,29	65	50,1
13	CMD QSD 4.2 SHERWOOD PUMP	8M0056956	SHE15000K	CEF500167			REC15000K	16	65	51,2

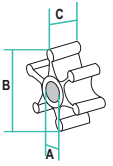



**KITS DE REPARACIÓN  
BOMBA DE AGUA**

**WATER PUMP  
SERVICE KITS**

**KIT RICAMBI  
POMPA ACQUA**

**KIT REPARATION DE  
POMPE À EAU**

1 | R | MR | ALPHA ONE

REF	OEM	
REC46-44292Q03	46-44292Q03	MR1 Alpha one (1984-90)



REF	OEM	
REC46-48748T1	46-48748A1 2495186 2763441	MR1 Alpha one (1967-69)





REF	OEM	
REC12120	46-96148A8	MR / ALPHA I (6225577+)





REF	OEM	
REC46-64141A11	46-64141A11	MC-1 (2062141-2791956)



REF	OEM	
REC46-48748T1	46-48748T1	MC-1 (1969+)



REF	OEM		NO
REC12110	MC-1 (2791957-6225576) (1970-83)		MR   ALPHA ONE



**KITS COMPLETOS**

**FULL KITS**

REF	OEM	
RECMC00002		MR Et ALPHA ONE (622557+)





**KIT COMPLETI**

**KITS COMPLETS**

REF	OEM	
RECMC00001		MC-1 (2663442-6225576)



REF	OEM	
REC46-96148A8	46-60367A1 46-96148A8 46-96148A5	Parte superior. Upper water pump housing. Parte superiore. Partie supérieur MC-1 & ALPHA-ONE



OEM				
324351	TAPA BOMBA	PUMP COVER	COPERCHIO POMPA	COUVERCLE POMPE
12-191833	JUNTA	GASKET	GUARNIZIONE	JOINT
23-29804T	TUBO AGUA	WATER TUBE	TUBO ACQUA	TUYAU
25-30224Q	ARO	O-RING	ANELLO	JOINT SPI
25-30271	ARANDELA	WASHER	RONDELLA	RONDELLE
25-30613	ARO	O-RING	ANELLO	JOINT SPI
25-33145	ARO	O-RING	ANELLO	JOINT SPI
25-90011	ARO	O-RING	ANELLO	JOINT SPI
26-455771	RETÉN	SEAL	TENUTA	JOINT SPI
27-32438	JUNTA	GASKET	GUARNIZIONE	JOINT
27-426311	JUNTA	GASKET	GUARNIZIONE	JOINT
27-856081	JUNTA	GASKET	GUARNIZIONE	JOINT
27-856091	JUNTA	GASKET	GUARNIZIONE	JOINT
27-856704	JUNTA	GASKET	GUARNIZIONE	JOINT
48-96148T1	CUERPO BOMBA	PUMP HOUSING	CORPO POMPA	CORPS
47-89984T4	IMPULSOR	IMPELLER	GIRANTE	TURBINE

REF	OEM	
REC47-89984Q5	47-89984Q5	MC-1 & ALPHA-ONE



OEM				
324351	TAPA BOMBA	PUMP COVER	COPERCHIO POMPA	COUVERCLE POMPE
12-191833	JUNTA	GASKET	GUARNIZIONE	JOINT
23-29804T	TUBO AGUA	WATER TUBE	TUBO ACQUA	TUYAU
25-30224Q	ARO	O-RING	ANELLO	JOINT SPI
25-30271	ARANDELA	WASHER	RONDELLA	RONDELLE
25-30613	ARO	O-RING	ANELLO	JOINT SPI
25-33145	ARO	O-RING	ANELLO	JOINT SPI
25-90011	ARO	O-RING	ANELLO	JOINT SPI
26-455771	RETÉN	SEAL	TENUTA	JOINT SPI
27-32438	JUNTA	GASKET	GUARNIZIONE	JOINT
27-426311	JUNTA	GASKET	GUARNIZIONE	JOINT
27-856081	JUNTA	GASKET	GUARNIZIONE	JOINT
27-856091	JUNTA	GASKET	GUARNIZIONE	JOINT
27-856704	JUNTA	GASKET	GUARNIZIONE	JOINT
47-89984T4	IMPULSOR	IMPELLER	GIRANTE	TURBINE
26-38970	ACOPLE GOMA	COUPLING	ACCOPIAMENTO	ACCOUPLMENT
25-38099	ARO	O-RING	ANELLO	JOINT SPI
25-26722	ARO	O-RING	ANELLO	JOINT SPI

### ALPHA ONE GEN II

REF	OEM	
REC47-43026Q06	47-43026Q06	



OEM				
47-43026Q2	IMPULSOR	IMPELLER	GIRANTE	TURBINE
8172761	PLACA	WEAR PLATE	PIASTRA	PLAQUE
27-8172771	JUNTA	GASKET	GUARNIZIONE	JOINT
27-430331	JUNTA	GASKET	GUARNIZIONE	JOINT
12-191833	JUNTA	GASKET	GUARNIZIONE	JOINT
28-8M0032833	CHAVETA	KEY	CHIAVE	CLAVETTE
26-816575A2	RETÉN	FACE SEAL	TENUTA	JOINT SPI
816597A1	ACOPAMIENTO	COUPLIN	ACCOPIAMENTO	ACCOUPLMENT

REF	OEM	
RECMC00004	47-89984Q5 (1991+)	



OEM				
8172761	PLACA	WEAR PLATE	PIASTRA	PLAQUE
27-430331	JUNTA	GASKET	GUARNIZIONE	JOINT
47-43026Q02	IMPULSOR	IMPELLER	GIRANTE	TURBINE
807929A1	RETÉN	PUMP SEAL CARRIER	TENUTA	JOINT SPI
27-8172772	JUNTA	GASKET	GUARNIZIONE	JOINT

REF	OEM	
REC817275Q05	817275Q05	D469859+



OEM				
46-96148T1	TAPA BOMBA	WATER PUMP HOUSING	COPERCHIO POMPA	COUVERCLE POMPE
27-430331	JUNTA	GASKET	GUARNIZIONE	JOINT
47-43026Q02	IMPULSOR	IMPELLER	GIRANTE	TURBINE
807929A1	RETÉN	SEAL	TENUTA	JOINT SPI
27-817272	JUNTA	GASKET	GUARNIZIONE	JOINT
8172761	PLACA	WEAR PLATE	PIASTRA	PLAQUE

## BRAVO I, II, III

REF	OEM	BOMBA PUMP POMPA POMPE
REC47-59362Q08	47-59362Q08	2 p, Plast.

REF	OEM
REC59503	59503

REF	OEM	
SHE15979	47-808145T	Diesel 7.3L

REF	OEM	BOMBA PUMP POMPA POMPE
REC47-59362T6	47-59362T6	1 p.

REF	OEM	BOMBA PUMP POMPA POMPE	
REC47-59362T5	47-59362T5	bronce brass bronzo Bronze	(-1982)

REF	OEM	BOMBA PUMP POMPA POMPE
REC46-807151A14	807151A14	1 p. Plast.

REF	OEM	
REC98-8M0121940	98-8M0121940	4.5 & 6.2L

REF	OEM	BOMBA PUMP POMPA POMPE
REC47-59362A4	47-59362A4	2 p.

DESPIECE BOMBA DE AGUA

WATER PUMP ASSY

ESPLOSO POMPA ACQUA

PIÈCES DE POMPE À EAU

BOMBA CON 2 PIEZAS DE PLÁSTICO  
2 PCS. PLASTIC PUMP  
POMPA CON 2 PZ IN PLASTICA  
POMPE A 2 PIÈCES EN PLASTIQUE

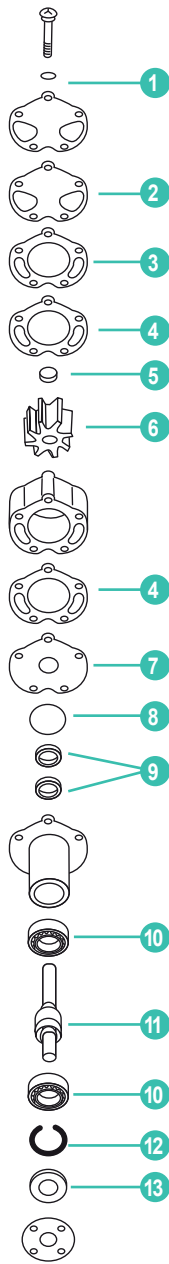

BOMBA CON 1 PIEZAS DE PLÁSTICO  
1 PCS. PLASTIC PUMP  
POMPA CON 1 PZ IN PLASTICA  
POMPE A 1 PIÈCE EN PLASTIQUE

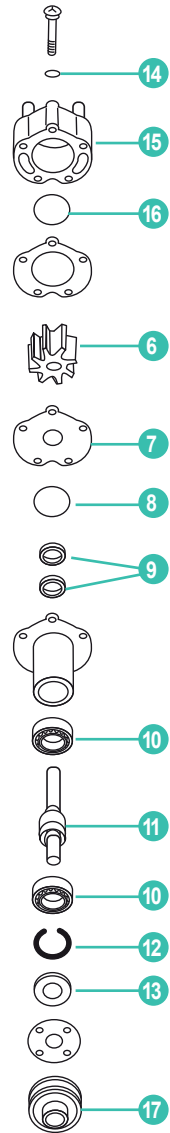

	REF	OEM					UN.
1	REC12-20084	12-20084	ARANDELA	WASHER	RONDELLA	RONDELLE	5
2	REC27-8052151	27-8052151	JUNTA	GASKET	GUARNIZIONE	JOINT	1
3	REC94916	94916	TAPA	WEAR PLATE	COPERCHIO	COUVERCLE	1
4	REC27-94914	27-94914	JUNTA	GASKET	GUARNIZIONE	JOINT	1
5	REC19-59504	19-59504	TAPÓN	PLUG	TAPPO	BOUCHON	1
6	REC47-59362Q01	47-59362Q01	IMPULSOR	IMPELLER	GIRANTE	TURBINE	1
7	REC94576	94576	TAPA	WEAR PLATE	PIASTRA	PLAQUE	1
8	REC25-94288	25-94288	ARO TÓRICO	O-RING	TENUTA	JOINT SPI	1
9	REC26-90562	26-90562	RETÉN	OIL SEAL	PARAOLIO	JOINT SPI	2
10	REC30-72961	30-72961	COJINETE	BEARING	CUSCINETTO	ROULEMENT	2
11	REC59501A1	59501A1	EJE	SHAFT	ASSE	ARBRE	1
12	REC53-23720	53-23720	ARO RETENEDOR	RETAINER RING	TENUTA	CLIPS	1
13	REC26-72785	26-72785	RETÉN ACEITE	OIL SEAL	PARAOLIO	JOINT SPI	1
14	PAGB/T97.1-8	12-36001	ARANDELA	WASHER	RONDELLA	RONDELLE	5
15	REC46-807151A14	46-807151A14	CUERPO BOMBA	PUMP HOUSING	CORPO POMPA	CORPS POMPA	1
16	REC25-33465	25-33465	ARANDELA	O-RING	RONDELLA	RONDELLE	1
17	REC861579	861579	POLEA	PULLEY	PULEGGIA	POULIE	1



POLEA BOMBA DE AGUA		WATER PUMPS PULLEY		PULIGGIA POMPE DELL'ACQUA		POULIE DE POMPE D'EAU	
POLEA CIGÜEÑAL		CRANKSHAFT PULLEY		PULIGGIA ALBERO MOTORE		POULIE VILEBREQUIN	
REF	OEM		Ø				
MP514693	33863 33863T	2	173 mm				
MP514720		2	6-3/4"				

MP514693

MP514720

POLEA BOMBA AGUA		WATER PUMP PULLEY		PULIGGIA POMPE DELL'ACQUA		POULIE DE POMPE D'EAU	
REF	OEM			Ø	BOMBA PUMP POMPA POMPE		
REC8M0153706 MP514516	8M0153706 807729T	V6 & V8 (SERPENTIN)	2	150 mm	REC46-8M0113734 REC46-8M0113735		

REC8M0153706

MP514516

POLEA PLANA SERPENTÍN		IDLER PULLEY		PULIGGIA PIANA SERPENTINA		POULIE PLANE SERPENTINE	
REF	OEM						
REC896332057	896332057	CMD 2.8 DMQSD 2.8 CMQSD 4.2					

POLEA GUÍA DE CORREA SERPENTÍN		GUIDE PULLEY		PULIGGIA DI GUIDA		POULIE DE GUIDE	
REF	OEM		Ø				
REC8M6500024	8M6500024	V6 & V8	80,96 mm				

TENSOR CORREA SERPENTÍN		BELT TENSIONER		TENDINGHIA		TENDEUR DE COURROIE	
REF	OEM		Ø				
REC8M0111642 REC807757T	8M0111642 898101425 807757T	CMQSD 2.8/4.2 V6 & V8					

REC807757T

REC8M0111642

TENSOR CORREA V6 & V8

V6 & V8  
BELT TENSIONER

TENDICINGHIA V6 E V8

TENDEUR DE COURROIE  
V6 ET V8

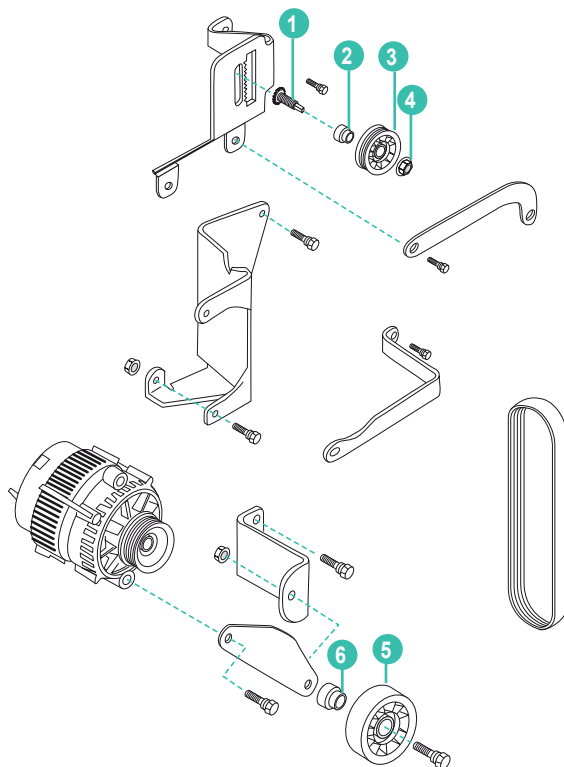

	REF	OEM				
1	REC8M0113182	8183812	PIÑÓN TENSOR	PINION STUD. SS	PIGNONE	PIGNON
2	REC865193	865193	CASQUILLO	BUSHING	BOCCOLA	BAGUE
3	REC864625T	864625T	POLEA	PULLEY (4.25" Ø)	PULEGGIA	POULIE
4	REC11-859135	859135	TUERCA	NUT	DADO	ÉCROU
5	REC8M6500024	865598	POLEA	PULLEY	PULEGGIA	POULIE
6	REC865193	865193	CASQUILLO	BUSHING	BOCCOLA	BAGUE

CORREAS

BELTS

CINGHIA

COURROIES

ALPHA

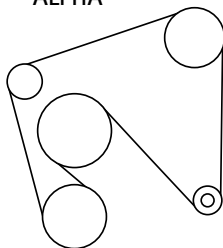

POWER STEERING

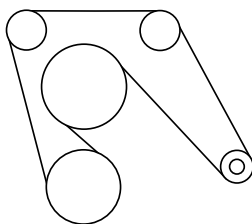

CLOSED COOLING

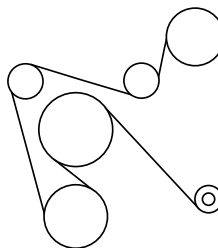

CLOSED COOLING &  
POWER STEERING

BRAVO

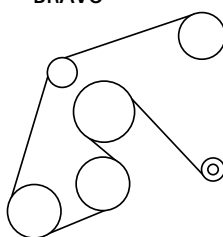

POWER STEERING

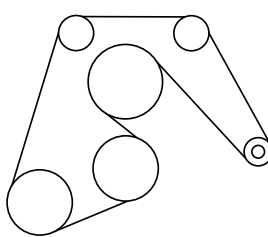

CLOSED COOLING

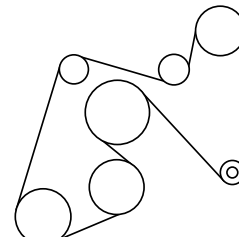

CLOSED COOLING &  
POWER STEERING

**GUÍA DE CORREAS  
BOMBA AGUA****V-BELTS GUIDE  
WATER POMPE****GUIDA CINGHIA MOTORE  
POMPA ACQUA****GUIDE DE COURROIES  
POMPE A EAU**

	SERIE	ALTERN.	DIRECCIÓN POWER STEERING IDROGUIDA DIRECTION	BOMBA AGUA SALADA SEA WATER PUMP POMPA ACQUA SALATA POMPE A EAU
CMD 1.7MS 120 I/L4	8810800	RM57-862054Q	RM57-862054Q	
CMD 1.7MI 120 L/L4	88109041	RM57-862054Q	RM57-862054Q	
CMD QSD 2.0 2.0EI, ES			REC57-879150023	
CMD QSD 2.8 & 4.2			REC57-898101580	

**GUÍA DE CORREAS  
BOMBA AGUA****V-BELTS GUIDE  
WATER POMPE****GUIDA CINGHIA MOTORE  
POMPA ACQUA****GUIDE DE COURROIES  
POMPE A EAU**

	SERIE	ALTERN.	DIRECCIÓN POWER STEERING IDROGUIDA DIRECTION	BOMBA AGUA SALADA SEA WATER PUMP POMPA ACQUA SALATA POMPE EAU
110	63-66	1537370 - 2044033	REC57-49043A1	
120	64-73	1666601-3770649	REC57-49043A1	
120	74-82	3770650-6229717	REC57-49043A1	REC57-65607Q (37")
120	74-82	3770650-6229717	REC57-49043A1	REC3852106 (40")
120(2.5L)	82-89	6229718 - C853255	REC57-49043A1	
120(2.5L)	82-89	6229718 - C853255 W/P/S	REC3852106	REC57-65607Q
140	68-73	2508261-3770649	REC57-49043A1	
140	74-82	3770650-6229717	REC57-49043A1	REC57-65607Q (37")
140	74-82	3770650-6229717	REC57-49043A1	REC3852106 (40")
140/3.0L/3.0LX	1982	6229718	REC57-49043A1	
140/3.0L/3.0LX	1982	6229718+ W/P/S	REC3852106	REC57-65607Q
150	64-66	1666495-2048646	REC57-49043A1	
160	67-69	2048022-2770031	REC57-49043A1	
165	70-73	2770032 - 3774864	REC57-49043A1	
165	74-81	3774865 - 5813433	REC57-49043A1	REC57-65607Q (37")
165	74-81	3774865 - 5813433	REC57-49043A1	REC3852106 (40")
165/170/180/190/3.7L	85-89	6916779 - C762299	REC57-49043A1	REC57-49043A1
470 (170HP)	83-84	6218037 - 6916778	REC57-49043A1	REC57-49043A1
488	83-84	6170297 - 6916778	REC57-49043A1	REC57-49043A1
175	1987	0B527955-0B773242	REC57-816295Q	REC57-816295Q
175/185/4.3L	85-92	A331455 - D714106	REC3858462	REC57-34359 REC966903
3.0L GM 181 I/L4		OW302000+	RM57-862054Q	
3.0 MPI EC		1A072812+	RM57-862054Q	
3.0 TKS Pus		1G404114+	RM57-862054Q	
4.3L	92-96	D714107 - F802999	REC829207	REC57-13457Q
4.3L (2bbl)	88-32	0B773243-0D714106	REC57-816295Q	
4.3L (GenII) (2 bbl)	92-96	0D714107-0F802999	REC57-816295Q	
4.3LX (4bbl)	88-92	0B775130-0D714369	REC57-816295Q	
4.3LX (Gen II)	92-96	0D714370-0F802999	REC57-816295Q	
888	71-77	3108723 - 4887829	REC3858462	
888	71-77	3108723 - 4887829	REC3858462	REC57-13457Q (30") REC3858462
898 W/O HIGH MT P/S	77-84	4762210 - 6218461	REC829207	REC966900 REC966903
898 W/ HIGH MT P/S	77-84	4762210 - 6218461	REC3858462	REC57-91035Q1 REC966903
898/200/5.0L	85-95	6218462 - F600999	REC3858462	REC57-91035Q1 REC966903
898/200/5.0L	85-95	6218462 - F600999	REC829207	REC57-34359 REC57-13457Q
200	1969	2453769 - 2712072	REC57-49043A1	
205	85-91	A331455 - D714369	REC3858462	REC57-34359 REC966903
215	70-72	2781153 - 3563181	REC3858462	
215 MIE	70-72	2781153 - 3563181	REC3858462	
225	73-74	3385721 - 4166999	REC3858462	REC57-34359 REC966903
225 MIE	73-74	3385721 - 4166999	REC3858462	
225 MCM/MIE	67-69	2278647 - 2694014	REC829207	
228 W/O HIGH MT P/S	77-82	4765100-6218461	REC829207	REC966900 REC966903
228 W/ HIGH MT P/S	77-82	4765100-6218461	REC3858462	REC57-91035Q1 REC966903
228/230/5.0L	83-95	6218462 - F600999	REC3858462	REC57-91035Q1 REC966903
228/230/5.0L	83-95	6218462 - F600999	REC829207	REC57-34359 REC57-13457Q
228 MIE	1977	4765100 - 4929030	REC829207	REC966900
228/230/5.0L MIE	78-87	4929030 - B788151	REC3858462	REC57-91035Q1 REC966903
228/230/5.0L MIE	78-87	4929030 - B788151	REC829207	REC57-34359 REC57-13457Q
233	75-77	4173000 - 4902304	REC3858462	
233	75-77	4173000 - 4902304	REC3858462	REC57-13457Q REC966903
233 MIE	75-76	4173000 - 4775784	REC3858462	
250	68-69	2314301 - 2639854	REC829207	
250	1977	4768000 - 4908849	REC3858462	REC966903 REC966903
255 MCM/MIE	73-74	3258728 - 4175499	REC3858462	
255	75-76	4175500 - 4498700	REC829207	
255	1976	4498701-4499060	REC829207	
255	1976	4499061-4767999	REC829207	
255 MIE	75-77	4175500 - 4498700	REC829207	
255 MIE	77-78	4498701 - 4924564	REC829207	REC966903

		SERIE	ALTERN.	DIRECCIÓN POWER STEERING IDROGUIDA DIRECTION	BOMBA AGUA SALADA SEA WATER PUMP POMPA ACQUA SALATA POMPE EAU
255/260/5.7L MIE Et Ski	78-86	4924565 - B522505	REC3858462		REC966903
260/5.7L MIE Et Ski	87-93	B522506 - F024999	REC3858462		REC966903
260/5.7L MIE Et Ski	87-93	B522506 - F024999	REC829207		REC57-13457Q
5.7L MIE Et Ski	94-96	F025000 - K040306	REC829207		REC57-13457Q
260 W/HM P/S	78-82	4908850 - 6218461	REC3858462	REC57-91035Q1	REC966903
260 W/LM P/S	1978-82	4908850 - 6218461	REC829207		REC966903
260/5.7L	1983-95	6218462 - F600999	REC3858462	REC57-91035Q1	REC966903
260/5.7L	1983-95	6218462 - F600999	REC829207	REC57-34359	REC57-13457Q
5.7L/5.7LX	1996	F601000 - K001526	REC829207	REC57-816295Q	REC57-13457Q
350 MAG	1986-95	A635178 - F600999	REC3858462	REC57-34359	REC966903
350 MAG	1986-95	A635178 - F600999	REC829207		REC57-13457Q
350 MAG	1996	F601000 - K001500	REC829207		REC57-13457Q
350 MAG Ski	1991-96	D505450 - K040005	REC829207		REC57-13457Q
Black Scorpion Ski	1996	F800000 - K040000	REC829207		REC57-13457Q
270 MCM/MIE	1969-72	2851074 - 3385720	REC829207		
280	1975	4176250 - 4176468	REC829207		
280	1975-76	4176469 - 4499390	REC829207		
280	1976	4499391 - 4499780	REC829207		
280	1976	4499781 - 4770199	REC829207		
5.7L	1988-96	0B525982-0F600999		REC57-816295Q	
5.7LEFI (2bbl)	1996	0F752400-0K001505		REC57-816295Q	
5.7L Alpha EFI (TBI)	1995	0F355305-0F752389		REC57-816295Q	
5.7L Bravo EFI (TBI)	1995	0F225560-0F752399		REC57-816295Q	
5.7LX Bravo EFI (Gen+)	1996	0F800300-0K001508		REC57-816295Q	
5.7LX EFI (4bbl TBI)	1996	0F752400-0K001505		REC57-816295Q	
320(EFI)	1987-89	A543604 - C622418	REC3858462	REC57-34359	
325 MCM/MIE	1968-74	2278747 - 3780449	REC57-48122Q		
330	1977-81	4623115-6083144	REC57-78200Q1		REC966903
330	1982-87	6083144 - B816540	REC57-78200Q1	REC57-96834Q (50")	REC966903
330	1982-87	6083144 - B816540	REC57-78200Q1	REC966931 (55")	REC57-13457Q
340 (7.4L)	1981-92	5889914 - D715493	REC57-78200Q1		REC966903
340 (7.4L)	1981-92	5889914 - D715493	REC57-78200Q1		REC57-13457Q
350 MIE	1974-75	3780450-4501640	REC57-48122Q		
350 MIE	1976	4501641 - 4623109	REC57-48122Q		REC966903
350 Mag Alpha	1987-95	0B525982-0F600999		REC57-816295Q	
350Mag Alpha (4bbl)	1996	0F601000-0K001526		REC57-816295Q	
350Mag Alpha EFI (Gen+)	1996	0F800300-0K001508		REC57-816295Q	
350Mag Bravo MPI	1995	0F415189-0F601999		REC57-816295Q	
350Mag Bravo MPI (Gen+)	1996	0F602000-0K001500		REC57-816295Q	
7.4L BRAVO	1988-91	B771113 - D603117	REC57-78200Q1	REC966931	REC57-13457Q
7.4L BRAVO	1988-91	B771113 - D603117	REC57-48122Q		REC57-13457Q
7.4L/LX BRAVO	1992-97	D603118 - K999999	REC57-48122Q		REC3852106
7.4LX Bravo (TBI)	1996-97	F820000 - K999999	REC57-48122Q		REC57-13457Q
7.4LX Bravo (MPI)	1996-97	F602010 - K147349	REC57-48122Q		REC3852106
7.4LX Bravo (MPI)	1997	K147350 - K999999	REC57-48122Q		REC57-13457Q
7.4L MIE	1989-92	C391564 - D715493	REC57-78200Q1		REC57-13457Q
7.4L MIE	1989-92	C391564 - D715493	REC57-48122Q		REC57-13457Q
7.4L MIE	1992-97	C391564 - K999999	REC57-48122Q		REC3852106
454 MAG Alpha	1986-88	A631894 +	REC57-78200Q1	REC57-96834Q (50")	
454 MAG Alpha	1986-88	A631894+	REC57-78200Q1	REC966931 (55")	
454 MAG	1988-92	B721206 - D805068	REC57-78200Q1	REC966931	REC57-13457Q
454 MAG	1988-92	B721206 - D805068	REC57-48122Q		REC57-13457Q
454 MAG	1992-97	D805069 - K999999	REC57-48122Q		REC3852106
454 MAG (MPI)	1994-97	F115700 - K147349	REC57-48122Q		REC3852106
454 MAG (MPI)	1997	K147350 - K999999	REC57-48122Q		REC57-13457Q
454 MAG Ski	1995-97	F215800 - K999999	REC57-48122Q		REC3852106
370(TRS)	1978-85	4179554 - 6721527	REC57-48122Q		
370(TRS)	1985-87	6721528 - B714586	REC57-48122Q	REC57-96834Q	
390 MCM/MIE	1969-70	2781129 - 3042731	REC57-48122Q		
400 (TRS)	1980-86	4179554 - B457644	REC57-48122Q		
420/425	1987-92	A398941 - D725499	REC57-48122Q	REC57-96834Q	
420/425	1992	D725500 - D937011	REC57-48122Q		REC3852106
440 (TRS)	1983-86	4179554 - B485220	REC57-48122Q		
450	1995-96	F347100 - F347227	REC57-48122Q		REC3852106
460 (TRS)	1983-86	4179554 - 6181046	REC57-48122Q		
502 MAG	1990-97	C878221 - D824588	REC57-48122Q		REC57-13457Q
502 MAG	1990-97	C824589 - K999999	REC57-48122Q		REC3852106
502 MAG (MPI)	1994-97	D840650 - K147349	REC57-48122Q		REC3852106
502 MAG (MPI)	1997	K147350 - K999999	REC57-48122Q		REC57-13457Q
8.2L MIE	1990-93	C878221 - D857199	REC57-48122Q		REC57-13457Q
8.2L MIE	1993-97	D857200 - K999999	REC57-48122Q		REC3852106
8.2L MPI MIE	1996-97	F819620 - K147349	REC57-48122Q		REC3852106
8.2L MPI MIE	1997	K147350 - K999999	REC57-48122Q		REC57-13457Q



## GUÍA DE CORREAS SERPENTIN

## SERPENTINE BELTS GUIDE

## GUIDA CINGHIA SERPENTINA MOTORE

## GUIDE DE COURROIS SERPENTINES



REF	OEM	LARGO LENGHT LUNGHEZZA LONGUEUR	ANCHO WIDHT LARGHEZZA LARGE
REC57-865615Q03	57-865615Q03	270,4 cm	
REC57-865615Q04	57-865615Q04	194,1 cm	
REC57-865615Q06	57-865615Q06	266,7 cm	
REC57-865615Q07	57-865615Q07	246,7 cm	
REC57-865615Q08	57-865615Q08	253,5 cm	2.06 cm
REC57-807755Q04	57-807755Q04	224,0 cm	
REC57-807755Q05	57-807755Q05	193,0 cm	
REC57-861049Q	57-861049Q	264,9 cm	
REC57-861757Q	57-861757Q	247,1 cm	

REF	OEM	LARGO LENGHT LUNGHEZZA LONGUEUR	ANCHO WIDHT LARGHEZZA LARGE
REC57-861758Q	57-861758Q	219,7 cm	
REC57-861759Q	57-861759Q	235,2 cm	
REC57-865615Q01	57-865615Q01	283,0 cm	
REC57-865615Q02	57-865615Q02	228,5 cm	
REC57-865615Q05	57-865615005	223,3 cm	2.06 cm
REC57-865615Q10	57-865615010	219,5 cm	
REC57-817113	57-817113	138,9 cm	
REC57-8M0097728	57-8M0097728 57-8M0074767	171,3 cm	
REC57-8M0088876	57-8M0088876	168,7 cm	



		SERIE	REF	NOTA FOOTNOTE NOTA NOTE
4.3L Alpha	1996-99	OF803000-OL618999	REC57-807755Q05	4
4.3L Alpha	1996-99	OF803000-OL618999	REC57-861758Q	2, 6
4.3L Alpha	1996-99	OF803000-OL618999	REC57-861759Q	2, 5
4.3L Alpha	2000-04	OL619000 +	REC57-865615Q04	3, 6, 7
4.3L Alpha	2000-04	OL619000+	REC57-865615Q08	4, 5, 7
4.3L Alpha	2000-04	OL619000+	REC57-865615Q03	3
4.3L Bravo	1996-99	OF803000-OL618999	REC57-861049Q	2, 5
4.3L Bravo	1996-99	OF803000-OL618999	REC57-861757Q	2, 6
4.3L Bravo	2000-04	OL619000+	REC57-865615Q08	4, 7
4.3L Bravo	2000-04	OL619000+	REC57-865615Q03	3
4.5 Et 6.2L Bravo Raw system			REC57-8M0097728	
4.5 Et 6.2L Bravo Fresh system			REC57-8M0088876	
5.0L Bravo	2002-04	OM600000+	REC57-865615Q06	3, 5, 7
5.0L Alpha	1998-99	OL012052-OL618999	REC57-807755Q05	4, 6
5.0L Alpha	1998-99	OL012052-OL618999	REC57-861049Q	5
5.0L Alpha	1998-99	OL012052-OL618999	REC57-861758Q	2, 6
5.0L Alpha	2000-04	OL619000+	REC57-865615Q06	3, 6, 7
5.0L Alpha	2000-04	OM600000+	REC57-865615Q06	3, 5, 7
5.0L Alpha	2001-04	OL619000+	REC57-865615Q08	4, 5, 7
5.0L Alpha	2001-04	OL619000+	REC57-865615Q03	3
5.0L Bravo	1998-99	OL012052-OL618999	REC57-861049Q	2, 5
5.0L Bravo	1998-99	OL012052-OL618999	REC57-861757Q	2, 6
5.0L Bravo	2000-04	OL619000+	REC57-865615Q08	4, 7
5.0L Bravo	2000-04	OL619000+	REC57-865615Q03	3
350 Mag, Alpha	1997-04	OK001501-OL618999	REC57-807755Q05	4, 6
350 Mag, Alpha	1997-04	OK001501-OL618999	REC57-861049Q	2, 5
350 Mag, Alpha	1997-04	OK001501-OL618999	REC57-861758Q	2, 6
350 Mag, Alpha	2000-04	OL619000+	REC57-865615Q07	3, 6, 7
350 Mag, Alpha	2002-04	OM600000+	REC57-865615Q06	3, 5, 7
350 Mag, Alpha	2000-04	OL619000+	REC57-865615Q08	4, 5, 7
350 Mag, Alpha	2000-04	OL619000+	REC57-865615Q03	3
350 Mag, Bravo	1997-04	OK001501-OL618999	REC57-861049Q	2, 5
350 Mag, Bravo	1997-04	OK001501-OL618999	REC57-861757Q	2, 6
350 Mag, Bravo	2002-04	OM600000+	REC57-865615Q06	3, 5, 7
350 Mag, Bravo	2000-04	OL619000+	REC57-865615Q08	4, 7
350 Mag, Bravo	2000-04	OL619000+	REC57-865615Q03	3
5.7L Alpha	1997-99	OK001501-OL618999	REC57-807755Q05	4, 6
5.7L Alpha	1997-99	OK001501-OL618999	REC57-861049Q	2, 5
5.7L Alpha	1997-99	OK001501-OL618999	REC57-861758Q	2, 6
5.7L Alpha	2000-04	OL619000+	REC57-865615Q08	3, 6, 7
5.7L Alpha	2000-04	OL619000+	REC57-865615Q03	3
5.7L Alpha	2000-04	OM600000+	REC57-865615Q06	3, 5, 7
5.7L Alpha	2000-04	OL619000+	REC57-865615Q08	3, 6, 7

### NOTA

- Usar con polea bomba de plástico Ø 4-3/4"
- Usar con polea bomba de metal Ø 4-3/4"
- Para motores con dirección hidráulica
- Para motores sin dirección hidráulica
- Para motores con circuito de refrigeración cerrado
- Para motores con refrigeración standard
- Para motores con alternadores montados en alto
- Intercambiador
- Alternador

### FOOTNOTE

- Use w/ plastic 4-3/4" Ø p/s pump pulley
- Use with metal 5-3/4" Ø p/s pump pulley
- For engines with power steering
- For engines without power steering
- For engines with closed cooling
- For engines with standard cooling
- Engines with high mounted alternators
- Blower
- Alternator

		SERIE	REF	NOTA FOOTNOTE NOTA NOTE
5.7L Alpha	2000-04	OL619000+	REC57-865615Q03	3
5.7L Bravo	1997-99	OK001501-OL618999	REC57-861049Q	2, 5
5.7L Bravo	1997-99	OK001501-OL618999	REC57-861757Q	2, 6
5.7L Bravo	2002-04	OM600000+	REC57-865615Q06	3, 5, 7
5.7L Bravo	2000-04	OL619000+	REC57-865615Q08	4, 7
5.7L Bravo	2000-04	OL619000+	REC57-865615Q03	3
5.7L Ski	1997-02	K040004-M316999	REC57-807755Q04	
377 Scorpion MCM	1999-04	OL416146+	REC57-861757Q	
377 Scorpion Ski	1997-98	K000656+	REC57-807755Q04	
454 Mag MPI	1998-01	OL010029-OM024999	REC57-861049Q	1
454 Mag MPI	1998-01	OL010029-OM024999	REC57-865615Q06	2
454 Mag MPI	1998-01	OL010029-OM024999	REC57-865615Q07	4
454 Mag MPI Horizon MIE	1998-01	OL002200-OL674000	REC57-865615Q07	
496 Mag Et HO	2000-04	OM025000+	REC57-865615Q01	
500 EFI	1999-04	L001477+	REC57-807755Q04	
502 Mag MPI	1998-01	OL017000-OM024999	REC57-861049Q	1
502 Mag MPI	1998-01	OL017000-OM024999	REC57-865615Q07	4
502 Mag MPI	1998-01	OL017000-OM024999	REC57-865615Q06	2
525 EFI	2003-04	OM900146+	REC57-865615Q02	
525 SC	1991-96	OD456000-745215	REC57-817113	
575 SCI	2000-04	OL306696+	REC57-807755Q04	9
575 SCI	2000-04	OL306696+	REC57-817113	8
600 SC	1991-96	OD456489 - OF877462	REC57-817113	
600 SC	1998	OK000227+	REC57-817113	
7.4L MPI	1998-01	OL010003-OM024330	REC57-861049Q	1
7.4L MPI	1998-01	OL010003-OM024330	REC57-865615Q06	2
7.4L MPI	1998-01	OL010003-OM024330	REC57-865615Q07	4
7.4L MPI MIE	1998-01	OL002006-OM025999	REC57-865615Q07	
Black Scorpion Ski	1997-01	K040004-M316999	REC57-807755Q04	
MX 6.2L Black Scorpion Ski	2001	L670015-M391599	REC57-807755Q04	
MX 6.2L MPI	2002-04	OM600000+	REC57-865615Q06	3, 5
MX 6.2L MPI	2000-04	OL680003+	REC57-865615Q08	4, 7
MX 6.2L MPI Horizon	2002-04	OM600000+	REC57-865615Q06	3
MX 6.2L MPI Horizon	2001-04	OM300000+	REC57-865615Q08	4
MX 6.2L MPI Horizon MIE	2001	M300000-M310099	REC57-807755Q04	
MX 6.2L MPI MIE Et HO	1999-01	L670000-M310099	REC57-807755Q04	
8.1S MPI MIE Et HO	2000-04	OM025000+	REC57-865615Q02	
8.2L MPI MIE	1998-01	OL002450-OL674200	REC57-865615Q07	

### NOTA

- Usare con puleggia pompa in plastica Ø 4-3/4"
- Usare con puleggia pompa in metallo Ø 4-3/4"
- Per motori con pompa idroguida
- Per motori senza pompa idroguida
- Per motori con circuito d'acqua chiuso
- Per motori con circuito aperto
- Per motori con alternatori montati nella parte superiore
- Scambiatore
- Alternatore

### NOTA

- Utilisation avec poulie de pompe en plastique Ø 4-3/4"
- Utilisation avec poulie de pompe métallique Ø 4-3/4"
- Pour les moteurs avec direction hydraulique
- Pour les moteurs sans direction hydraulique
- Pour les moteurs avec circuit de refroid. fermé
- Pour les moteurs avec refroid. standard
- Pour les moteurs avec alternateurs montés en tête
- Echangeur
- Alternateur

**GUÍA DE CORREAS SERPENTIN****SERPENTINE BELTS GUIDE****GUIDA CINGHIA SERPENTINA MOTORE****GUIDE COURROIES SERPENTIN**

	REF	OEM	
CMD / D1.7L	REC57-882531	57-882531 57-882531T	ALT
CMD QSD 2.0 115/130/150/170	REC57-879172120	57-879172120	
CMD QSD 2.8 170/210/220/230	REC57-879194425	57-879194425 57-898101624	
CMD QSD 4.2 270/320/350	REC57-898101579	57-898101579	
TDI 3.0L V6	REC57-8M0093495	57-8M0093495 8M0067268	ALT & POWER STEERING

**GUÍA DE CORREAS MOTOR****V-BELTS GUIDE****GUIDA CINGHIA MOTORE****GUIDE COURROIES DE MOTEUR**

REF	OEM
REC57-13457Q	57-13457Q
REC966931	57-13458Q
REC3852106	57-32850 57-69143Q
REC57-34359	57-34359 57-37619T, Q
REC57-36356	57-36356
REC3858462	57-45856 57-49213A1
REC829207	57-93658Q
REC57-48122Q	57-48120Q1
REC57-48122Q	57-48122Q

REF	OEM
REC57-49043A1	57-49043A1 57-64032Q1
REC57-64416	57-49211 57-64416
REC57-52692	57-52692
REC57-65607Q	57-65607T 940 mm
REC966903	57-74271Q
REC966900	57-77274
REC57-78200Q1	57-78200Q1
REC57-816295Q	57-816295Q
REC57-91035Q1	57-91035Q1

**MANGUITOS DE MOTOR HOSES****MANICOTTO MOTORE****TUYAU MOTEUR****TOMA DE AGUA****WATER SYSTEM****PRESA ACQUA****ENTRÉE D'EAU**

REF	OEM	Ø	
REC32-4172533	32-4172533 32-8M0062309	3/4"	13 <sup>7/8</sup> "
REC32-32461	32-32461 32-32461A1	5/8"	13 <sup>7/8</sup> "



REF	OEM	
REC32-52481	32-52481	GM 4 & 6 CYL Inline



REF	OEM	
REC32-43437	32-43437	Bravo Design I

















REF	OEM	
REC8M0062102	32-8M0062102	Bravo Design II

**CULATA --> COLECTOR ESCAPE****CYLINDER HEAD --> EXHAUST MANIFOLD****TESTATA --> COLLECTORE DI SCARICO****CUJASSE --> COLLECTEUR D'ÉCHAPPEMENT**

REF	OEM	
REC32-89653	32-89653	1 1/4" ID 5"



BOMBA DE AGUA	WATER PUMP	POMPA ACQUA	POMPE D'EAU												
<table border="1"> <tr><th>REF</th><th>OEM</th></tr> <tr><td>RM32-805375</td><td>32-805375</td></tr> </table> 	REF	OEM	RM32-805375	32-805375		<table border="1"> <tr><th>REF</th><th>OEM</th></tr> <tr><td>REC32-33189</td><td>32-33189</td></tr> </table>  <table border="1"> <tr><th>REF</th><th>OEM</th></tr> <tr><td>REC32-897181</td><td>32-897181</td></tr> </table> 	REF	OEM	REC32-33189	32-33189	REF	OEM	REC32-897181	32-897181	
REF	OEM														
RM32-805375	32-805375														
REF	OEM														
REC32-33189	32-33189														
REF	OEM														
REC32-897181	32-897181														
<b>BOMBA DE AGUA --&gt; ENFRIADOR DE ACEITE</b>	<b>MOLDED SEAWATER PUMP --&gt; OIL COOLER</b>	<b>POMPA DELL' ACQUA --&gt; SCAMBIATORE DELL'OLIO</b>	<b>POMPE D'EAU --&gt; ÉCHANGEUR D'HUILE</b>												
<table border="1"> <tr><th>REF</th><th>OEM</th></tr> <tr><td>REC32-88795</td><td>32-88795</td></tr> </table> 	REF	OEM	REC32-88795	32-88795		<table border="1"> <tr><th>REF</th><th>OEM</th></tr> <tr><td>REC32-860205</td><td>32-860205</td></tr> </table> 	REF	OEM	REC32-860205	32-860205					
REF	OEM														
REC32-88795	32-88795														
REF	OEM														
REC32-860205	32-860205														
<table border="1"> <tr><th>REF</th><th>OEM</th></tr> <tr><td>REC32-887952</td><td>32-887952</td></tr> </table> 	REF	OEM	REC32-887952	32-887952		<table border="1"> <tr><th>REF</th><th>OEM</th></tr> <tr><td>REC32-8080441</td><td>32-808044-1</td></tr> </table> 	REF	OEM	REC32-8080441	32-808044-1					
REF	OEM														
REC32-887952	32-887952														
REF	OEM														
REC32-8080441	32-808044-1														
<b>ENFRIADOR DE ACEITE --&gt; ENFRIADOR DE ACEITE</b>	<b>OIL COOLER --&gt; OIL COOLER</b>	<b>SCAMBIATORE DELL'OLIO --&gt; SCAMBIATORE DELL'OLIO</b>	<b>REFROIDISSEUR D'HUILE--&gt; REFROIDISSEUR D'HUILE</b>												
<table border="1"> <tr><th>REF</th><th>OEM</th></tr> <tr><td>REC32-8600891</td><td>32-8600891</td></tr> </table> 	REF	OEM	REC32-8600891	32-8600891											
REF	OEM														
REC32-8600891	32-8600891														
<b>TRANSOM --&gt; ENFRIADOR DE ACEITE</b>	<b>TRANSOM --&gt; OIL COOLER</b>	<b>TRANSOM --&gt; SCAMBIATORE DELL'OLIO</b>	<b>TRANSOM --&gt; REFROIDISSEUR D'HUILE</b>												
<table border="1"> <tr><th>REF</th><th>OEM</th></tr> <tr><td>REC32-807661</td><td>32-807661</td></tr> </table> 	REF	OEM	REC32-807661	32-807661		<table border="1"> <tr><th>REF</th><th>OEM</th></tr> <tr><td>REC32-96246A4</td><td>32-96246A4</td></tr> </table> 	REF	OEM	REC32-96246A4	32-96246A4					
REF	OEM														
REC32-807661	32-807661														
REF	OEM														
REC32-96246A4	32-96246A4														
<b>ENFRIADOR --&gt; CUERPO DE TERMOSTATO</b>	<b>COOLER --&gt; THERMOSTAT HOUSING</b>	<b>SCAMBIATORE --&gt; CORPO TERMOSTATO</b>	<b>REFROIDISSEUR --&gt; CORPS THERMOSTAT</b>												
<table border="1"> <tr><th>REF</th><th>OEM</th></tr> <tr><td>REC32-806856</td><td>32-806856</td></tr> </table> 	REF	OEM	REC32-806856	32-806856		<table border="1"> <tr><th>REF</th><th>OEM</th></tr> <tr><td>RM32-806209-1</td><td>32-806209-1</td></tr> </table> 	REF	OEM	RM32-806209-1	32-806209-1					
REF	OEM														
REC32-806856	32-806856														
REF	OEM														
RM32-806209-1	32-806209-1														
<table border="1"> <tr><th>REF</th><th>OEM</th></tr> <tr><td>REC32-807407</td><td>32-807407</td></tr> </table> 	REF	OEM	REC32-807407	32-807407		<table border="1"> <tr><th>REF</th><th>OEM</th></tr> <tr><td>REC32-16012</td><td>32-16012</td></tr> </table> 	REF	OEM	REC32-16012	32-16012					
REF	OEM														
REC32-807407	32-807407														
REF	OEM														
REC32-16012	32-16012														
<table border="1"> <tr><th>REF</th><th>OEM</th></tr> <tr><td>REC32-808033</td><td>32-808033</td></tr> </table> 	REF	OEM	REC32-808033	32-808033											
REF	OEM														
REC32-808033	32-808033														

**CUERPO TERMOSTATO  
--> COLECTOR ESCAPE  
ESTRIBOR**

REF	OEM
REC32-871171	32-87117 1 32-87117



**THERMOSTAT HOUSING  
--> STARBOARD  
EXHAUST MANIFOLD**

REF	OEM
REC32-807697	32-807697



REF	OEM
REC32-897401	32-897301



**CORPO TERMOSTATO -->  
COLLETTORE SCARICO  
DESTRO**

REF	OEM
REC32-8066351	32-8066351



REF	OEM
RM32-861057	32-861057



REF	OEM
REC32-8066361	32-8066361



**CUERPO TERMOSTATO  
--> COLECTOR ESCAPE  
BABOR**

REF	OEM
REC32-160211	32-16021 1



**THERMOSTAT HOUSING  
--> PORT EXHAUST  
MANIFOLD**

REF	OEM
REC32-33220	32-33220 32-3322070 32-8M0062614



**CORPO TERMOSTATO -->  
COLLETTORE SCARICO  
SINISTRO**

REF	OEM
REC32-52481	32-52481



REF	OEM
REC32-862124	32-862124



REF	OEM
RM32-860144	32-860144

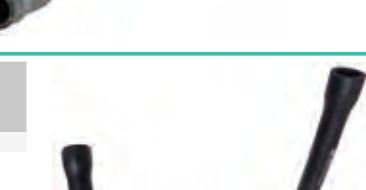

REF	OEM
REC32-897491	32-89749-1



REF	OEM
REC32-862139	32-862139



REF	OEM
RM32-860331	32-860331



**CORPS THERMOSTAT -->  
COLLECTEUR EPUISEUR  
TRIBORD**



**CORPS THERMOSTAT  
--> COLLECTEUR EPUISEUR  
BABORD**

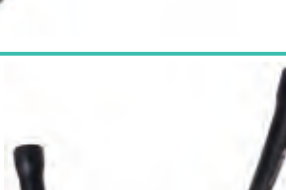



**CUERPO TERMOSTATO  
--> COLECTOR  
DELANTERO**

**THERMOSTAT HOUSING  
--> FRONT MANIFOLD**

**CORPO TERMOSTATO -->  
COLLETTORE FRONTALE**

**CORPS THERMOSTAT -->  
COLLECTEUR FRONTAL**

REF	OEM
REC32-48132	32-48132



**GUÍA MANGUITOS (COLA)**

**HOSES FUEL GUIDE  
(STERN DRIVES)**

**GUIDA MANICOTTO  
(PIEDE)**

**GUIDE DE LA DOUILLE  
(EMBASES)**

MOD	SERIE	TERMOS. --> BOMBA THERMOS. --> PUMP THERMOS. --> POMPA THERMOS. --> POMPE	ESTRIBOR STB DESTRO TRIBORD	TERMOS. --> COLECTOR. THERMOS. --> MANIFOLD THERMOS. --> COLLETTORE THERMOS. --> COLLECTEUR	BABOR PORT SINISTRO BABORD	ESCAPE EXHAUST SCARICO ÉCHAPPEMENT	TRANSOM TRANSOM TRANSOM TRANSOM	ENFRIADOR ACEITE OIL COOLER SCAMBIATORE DELL'OLIO REFROIDISSEMENT D'HUILE	TERMOSTATO THERMOSTAT THERMOSTATO THERMOSTAT	BOMBA WATER PUMP POMPA POMPE
120	1666601-3377340	REC32-8M0071007				REC32-52481				
120	3377341-5192048	REC32-8M0071007				REC32-52481				
120	5192049-6229717	REC32-8M0071007				REC32-52481				
120/2,5L	6229718-0B531853	REC32-8M0071007				REC32-52481				
140	2508261-3332137	REC32-8M0071007				REC32-52481				
140	3332138-5157669	REC32-8M0071007				REC32-52481				
140	5157669-6229717	REC32-8M0071007				REC32-52481				
140/3.0L	6229718-0C856558	REC32-8M0071007				REC32-52481				
3.0L/LX	0C856559-0F603999	REC32-8M0071007				REC32-52481				
3.0LX	0G604000+	REC32-8M0071007				REC32-52481				
140	1538930-1725960	REC32-8M0071007				REC32-52481				
488 (4bbl)	6170297-6916778							REC32-33220		
190 (4bbl)	6916779							REC32-33220		
180/3.7LX (4bbl)	6916779							REC32-33220		
185 (4bbl)	6330183-6919655	REC32-33189								
165	2770032-5178958					REC32-52481				
165	5178959-5813433					REC32-52481				
185 (2bbl)	0A331455-0B527954	REC32-33189						REC32-33220		
175/4.3 (2bbl)	0B527955-0D714106	REC32-33189						REC32-33220		
4.3L (GEN II) (2bbl)	0D714107-0F00877	REC32-33189	REC32-871171	REC32-160211				REC32-806856		
4.3L (GEN II) (2bbl)	0F000878-0F601126		REC32-8066361	REC32-8066351			REC32-806856			
4.3L (GEN II) (2bbl)	0F601127-0F802999	REC32-33189	REC32-8066361	REC32-8066351			REC32-806856		REC27-68714A6	
4.3LX (GEN+) (2bbl)	0F803000+	REC32-33189	REC32-807697	RM32-860144				REC32-16012	REC27-68714A6	
205 (4bbl)	0A331455-0B527954	REC32-33189	REC32-871171					REC32-16012		
205/4.3LX (4bbl)	0B527955-0D714639	REC32-33189						REC32-16012		
4.3L (GEN II) (2bbl)	0D714370-0F001219	REC32-33189					REC32-807661	REC32-16012		
4.3L (GEN II) (2bbl)	0F001220-0F601126	REC32-33189	REC32-8066361	REC32-8066351	REC32-807661	REC32-16012				
4.3L (GEN II) (2bbl)	0F601127-0F802999	REC32-33189	REC32-8066361	REC32-8066351	REC32-807661	REC32-16012				
4.3LX (GEN+) (4bbl)	0F803114+	REC32-33189	REC32-807697	RM32-860144			REC32-807661	REC32-16012	REC32-860205	
200	2453769-2712072					REC32-52481				
225 (4bbl)	3385721-4166999	REC32-33189								
225-S (4bbl)	3385721-416999	REC32-33189								
200 (2bbl)	6218462-0B525981	REC32-33189	REC32-871171	REC32-160211			REC32-96246A4	REC32-806856	REC27-68714A6	
200/5.0L (2bbl)	0B525982-0F600999	REC32-33189	REC32-8066361	REC32-8066351	REC32-96246A4	REC32-96246A4	REC32-806856	REC32-887952		
230 (4bbl)	6218462-0B525981	REC32-33189	REC32-871171	REC32-160211			REC32-96246A4	REC32-806856	REC27-68714A6	
230/5.0LX (4bbl)	0B525982-0F600999	REC32-33189	REC32-8066361	REC32-8066351	REC32-96246A4	REC32-96246A4	REC32-806856	REC32-887952		
250	4768000-4908849	REC32-33189	REC32-871171							
260	6218462-0B525981	REC32-33189					REC32-96246A4	REC32-806856	REC27-68714A6	
260	6218462-0B525981	REC32-33189					REC32-96246A4			
260/5.7L	0B525982-0F600999	REC32-33189	REC32-8066361	REC32-8066351	REC32-96246A4	REC32-96246A4	REC32-806856	REC32-887952		
5.7 ALPHA (2bbl)	0F601000+	REC32-33189	REC32-8066361	REC32-8066351	REC32-807661	REC32-807661	REC32-806856	REC32-887952		
5.7L ALPHA (EF) TBI	0F355305-0F752399	REC32-33189	REC32-8066361	REC32-8066351	REC32-96246A4	REC32-96246A4	REC32-806856	REC32-887952		
5.7L ALPHA (2bbl. -TBI)	0F752400+	REC32-33189	REC32-8066361	REC32-8066351	REC32-807661	REC32-807661	REC32-806856	REC32-887952		
5.7LX ALPHA (4bbl)	0F601000+	REC32-33189	REC32-8066361	REC32-8066351			REC32-806856	REC32-887952		
5.7LX ALPHA (4bbl. -TBI)	0F752400+	REC32-33189	REC32-807697	REC32-8066351			REC32-806856	REC32-887952		
5.7L BRAVO	0B525982-0F600999								REC32-887952	
5.7L BRAVO (2bbl)	0F601000+								REC32-887952	
5.7L BRAVO (EF) TBI	0F225560-0F752399		REC32-8066361	REC32-8066351			REC32-96246A4	REC32-806856	REC32-887952	
5.7L BRAVO (2bbl. -TBI)	0F752400+	REC32-33189	REC32-807697	REC32-8066351					REC32-887952	

MOD	SERIE	TERMOS. --> BOMBA THERMOS. --> PUMP TERMOS. --> POMPA THERMOS. --> POMPE	ESTRIBOR STB DESTRO TRIBORD	BATOR PORT SINISTRO BORD	ESCAPE EXHAUST SCARICO ÉCHAPPEMENT	ENFRIADOR ACEITE OIL COOLER SCAMBIATORE DELL'OLIO REFROIDISSEMENT D'HUILE		
						TRANSOM TRANSOM TRANSOM TRANSOM	TERMOSTATO THERMOSTAT TERMOSTATO THERMOSTAT	BOMBA WATER PUMP POMPA POMPE
5.7LX BRAVO (4bb)	0F601000+		REC32-8066361	REC32-8066351				REC32-887952
5.7LX BRAVO (4bb)-TBI)	0F752400+	REC32-33189	REC32-807697	REC32-8066351				REC32-887952
5.7LX BRAVO (TBI)(GEN +)	0F800300+	REC32-33189	REC32-8066351	REC32-8066351			REC32-806856	REC32-887952
350 Mag. ALPHA	0A635178-0B525981	REC32-33189	REC32-871171	REC32-160211		REC32-96246A4		REC32-887952
350 Mag. ALPHA	0B525982-0F600999	REC32-33189	REC32-8066361	REC32-8066351		REC32-96246A4	REC32-806856	REC32-887952
350 Mag. ALPHA (4bb)	0F601000+	REC32-33189	REC32-8066361	REC32-8066351		REC32-807661	REC32-806856	REC32-887952
350 Mag. ALPHA (TBI) (Gen+)	0F800300+	REC32-33189	REC32-8066361	REC32-8066351		REC32-807661	REC32-806856	REC32-887952
350 Mag. BRAVO (MPI)	0F415189-0F601999	REC32-33189	REC32-8066361	REC32-8066351		REC32-807661	REC32-806856	REC32-887952
350 Mag BRAVO (MPI)(GEN+)	0F602000+	REC32-33189	REC32-8066361	REC32-8066351		REC32-807661	REC32-806856	REC32-887952
270	2851074-3385720							
300 TEMPEST	6668677-0B430367	REC32-33189				REC32-96246A4		
320 (EFI)	0A543604-0B157602	REC32-33189				REC32-96246A4		
320 (EFI)	0B157603-0C622418	REC32-33189				REC32-96246A4		
325	2278747-3780449				REC32-48132			
330	4623115-6083144				REC32-48132			
330	6083145-0B816540			REC32-897491				
7.4L BRAVO	0B771113-0D603117		REC32-52481	REC32-897491				
7.4LX BRAVO (Gen.V)	0D603118-0F800699	REC32-897181		REC32-897491				
7.4LX BRAVO (MP)	0F602010+	REC32-897181	REC32-807697	REC32-897491				
450 Mag. ALPHA	0A631894-0B785148					REC32-96246A4		
454 Mag. BRAVO	0B721206-0D805068			REC32-897491				
454 Mag. BRAVO (Gen.V)	0D805069-0F304999	REC32-897181	REC32-807697	REC32-897491				
454 Mag. BRAVO (Gen.V)	0F305000-0F801699	REC32-897181		REC32-897491				
454 EFI (Gen.V)	0F115700-0F802349	REC32-897181						
370TRS	4179554-6721527				REC32-48132			
370TRS	6721528-0B714586		REC32-807697	REC32-897491				
400TRS	4179554-0B457644				REC32-48132			
420	0A398941-0B622418	REC32-897181						
425	0A398941-0B622418	REC32-897181						
425 (Gen.V)	0A398941-0B622418	REC32-897181						
440TRS	4179554-0B485220				REC32-48132			
450 (Gen.V)	0F347100-0F615761	REC32-897181		REC32-897491				
460 TRS	4179554-6181046				REC32-48132			
465	0C84992-0F213244	REC32-897181						
465 (Gen.V)	0C84992-0F213244	REC32-897181						
500 (Gen.V)	0F213293+	REC32-897181		REC32-897491				
502 Mag. BRAVO	0C878221-0D824588	REC32-897181		REC32-897491				
502 Mag. BRAVO (Gen.V)	0D824589-0F114528	REC32-897181		REC32-897491				
502 EFI (Gen.V)	0D840650-0F802599	REC32-897181		REC32-897491				

GUÍA MANGUITOS      HOSES FUEL GUIDE      GUIDA MANICOTTO      GUIDE TUYAUX



MOD	SERIE	TERMOS. --> BOMBA THERMOS. --> PUMP TERMOS. --> POMPA THERMOS. --> POMPE
530D-TA(BRAVO)	0B993002-0D725151	RM32-805375
D183 Turbo AC (BRAVO)	0B993002-0D725151	RM32-805375
D3.0L (BRAVO)	0D725152+	RM32-805375
636D-TA (BRAVO)	0B993002-0D850127	RM32-805375
D219 Turbo AC (BRAVO)	0B993002-0D850127	RM32-805375
D3.6L (BRAVO)	0D850128+	RM32-805375
D4.2L (BRAVO)	0D554732+	RM32-805375
D3.0L	0D725152+	RM32-805375

**GUÍA MANGUITOS  
(EJE - GASOLINA)**
**HOSES FUEL GUIDE  
(SHAFT - FUEL)**
**GUIDA MANICOTTO  
(ASSE - BENZINA)**
**GUIDE TUYAUX  
(ARBRE - ESSENCE)**

MOD	SERIE	TERMOS. --> BOMBA THERMOS. --> PUMP TERMOS. --> POMPA THERMOS. --> POMPE	TERMOS. --> COLECTOR. THERMOS. --> MANIFOLD TERMOS. --> COLLETORE THERMOS. --> COLLECTEUR			ENFRIADOR ACEITE OIL COOLER SCAMBIATORE DELL'OLIO REFROIDISSEMENT D'HUILE		
			ESTRIBOR STB DESTRO TRIBORD	BABOR PORT SINISTRO BABORD	ESCAPE EXHAUST SCARICO ÉCHAPPEMENT	TRANSOM TRANSOM TRANSOM TRANSOM	TERMOSTATO THERMOSTAT TERMOSTATO THERMOSTAT	BOMBA WATER PUMP POMPA POMPE
198 MIE (2bbl.)	4762210-6218461	REC32-33189			REC32-48132			
228 MIE (4bbl.)	4765100-5170008	REC32-33189			REC32-48132			
228 MIE (4bbl.)	5170009-5907057	REC32-33189						
230 MIE (4bbl.)	5907058-0B522505	REC32-33189			REC32-48132		REC27-68714A6	
230/5.0L MIE (4bbl.)	0B522506-0B788151	REC32-33189			REC32-48132		REC27-68714A6	
225MIE	2278647-2694014				REC32-33189			
250 MIE	2314301-2639854	REC32-33189			REC32-33189			
255 MIE	4175500-5195908	REC32-33189			REC32-33189			
255 MIE	5195909-5907057	REC32-33189			REC32-48132			
260 MIE	5900758-0B522505	REC32-33189			REC32-48132		REC27-68714A6	
260/5.7 MIE	0B522506-0F024999	REC32-33189			REC32-48132		REC27-68714A6	
5.7L MIE	0F025000+	REC32-33189	REC32-871171		REC32-33189	REC32-806856		
5.7L (SKI) MIE	0A338533-0B514626	REC32-33189						
5.7L (COMP. SKI)	0B514627-0F775199	REC32-33189	REC32-871171					
5.7L (COMP. SKI) (2bbl.)	0F775200+	REC32-33189	REC32-8066361	REC32-8066351		REC32-806856		
350 Mag. (SKI) CARB	0D505450+	REC32-33189	REC32-871171			REC32-806856	REC32-860205	
350 Mag. (SKI) (9EFI)TBI	0F215561+	REC32-33189	REC32-8066361	REC32-8066351		REC32-806856	REC32-860205	
350 Mag. (SKI) (9EFI)MPI	0F350583+	REC32-33189	REC32-8066361	REC32-8066351			REC32-860205	
BLACK SCORPION (GEN+)	0F800000+		REC32-807697	REC32-8066351		REC32-806856	REC32-860205	REC32-8600891
270 MIE	2851074-3077735	REC32-33189						
325 MIE	2278747-3780449				REC32-48132			
330 MIE	4623115-5889913				REC32-48132			
7.4L MIE w/hurth	0C391564-0D715493	REC32-897181		REC32-897491				
7.4L MIE (Ih) Gen.V	0D715494-0F820141	REC32-897181		REC32-897491				
7.4L EFI MIE (LH) Gen.V	0F563052-0F820103	REC32-897181						
390 MIE	2781129-2820559				REC32-48132			
8.2L MIE w/hurth	0C878221-0D857199	REC32-897181		REC32-897491				
8.2L MIE (Gen.V)	0D857200-0F819619	REC32-897181		REC32-897491				

# PARTES DEL MOTOR ENGINE PARTS

# PARTI MOTORE PIECES MOTEUR

## JUNTAS PARA BASES GM Y FORD

Los Kits están diseñados y catalogados específicamente para aplicaciones marinas. Su calidad es superior a las juntas originales.

## MARINE GASKETS TO GM & FORD ENGINES

The gaskets kits are designed and cataloged specifically for marine engine applications. Their quality is even better than the oem's.

## GUARNIZIONI PER MOTORI GM E FORD



I kit di guarnizioni sono disegnati e fabbricati specificatamente per applicazioni marine. La qualità è assolutamente paragonabile a quelle originali.

## JOINTS POUR MOTEURS GM ET FORD

Les kits sont spécifiquement conçus et catalogués pour les applications marines. Leur qualité est supérieure à celle des joints d'origine.

SERIE SERIAL				
1700-17099	KIT JUNTAS DE CULATA (pack individual)	CYLINDER HEAD GASKET (single-packed)	GUARNIZIONI TESTATA (quantità 1)	KIT JOINTS DE CULASSE (paquet individuel)
17100-17199	JUEGOS DE CONVERSIÓN Todas las juntas y retenes de aceite que no se encuentran en los juegos de culata. Incluye las juntas del cárter y los retenes.	CONVERSION KITS All gaskets and oil seals not found in a Head Set. This includes timing cover gaskets and seals, oil pan gaskets, and rear main bearing seals.	KIT PARTE BASSA Include tutte le guarnizioni ed i paraoli della parte bassa del motore, viene fornita anche la guarnizione della coppa dell'olio.	KITS DE CONVERSION Tous les joints d'étanchéité et joints d'huile qui ne sont pas contenus dans les kits de culasse. Comprend les joints de carter et les joints d'huile.
17200-17299	KIT DE DESCARBONIZACIÓN Todas las juntas y retenes necesarios para el trabajo de las válvulas, incluyendo la culata, la tapa de la válvula y juntas de colector de admisión y colector de escape. (Los juegos de 4 cyl no contienen las juntas del colector de admisión/escape. Deben pedirse por separado).	HEAD SETS SERIES All gaskets and seals necessary for a valve grinding job, including cylinder head gaskets, valve cover gaskets, intake & exhaust manifold gaskets (except 4 cyl intake set), and valve stem seals.	KIT PARTE ALTA (SMERIGLIO) Include tutte le guarnizioni ed i paraoli della parte alta del motore, testate, carter distribuzione, aspirazione e scarico. (Motori a 4 cyl. la guarnizione aspirazione è da ordinare separatamente).	KIT DE DÉCARBONISATION Tous les joints requis pour le travail sur les soupapes, y compris les joints de culasse, de couvercle de soupape, de collecteur d'admission et d'échappement (les kits 4 cylindres ne contiennent pas de joints de collecteur d'admission/échappement). Ils doivent être commandés séparément.
17300-17399	KIT DE COLECTOR DE ADMISIÓN Juntas de la parte de admisión del colector, retenes y juntas de la base del distribuidor.	INTAKE MANIFOLD SETS Intake manifold side gaskets, intake manifold end seals, and distributor mounting gasket.	KIT GUARNIZIONE ASPIRAZIONE Guarnizioni laterali del collettore di aspirazione, guarnizioni e guarnizioni della base del distributore.	KIT DE COLLECTEUR D'ADMISSION Joints de collecteur d'admission, joints d'étanchéité et joints de base de distributeur.
17400-17499	KIT DE COLECTOR DE ESCAPE (de colector a culata)	EXHAUST MANIFOLD (manifold-to-cylinder head gaskets)	KIT GUARNIZIONE SCARICO (dalla testata al collettore)	KIT COLLECTEUR D'ÉCHAPPEMENT (collecteur à la culasse)
17700-17749	KIT DE CONTRARROTACIÓN RETÉN TRASERO DEL CIGÜENAL Retenes traseros del cigüeñal diseñados para motores de rotación opuesta a la normal. (Retenes de rotación normal incluidos en el set de conversión)	REVERSE ROTATION REAR MAIN BEARING SEAL SETS Rear main bearing seals designed to seal a crankshaft which rotates in the opposite direction from normal (Standard rotation seal is included in conversion set)	PARAOLIO MOTORI CONTROROTANTI ALBERO MOTORE Nei motori rotazione STD il paraolio viene già incluso nel kit della parte bassa. (Guarnizioni a rotazione normale incluse nel set di conversione)	KIT CONTRE-ROTATION JOINTS D'HUILE DE VILEBREQUIN ARRIÈRE Joints de vilebrequin arrière conçus pour les moteurs à contre-rotation (joints à rotation normale inclus dans le kit de conversion).
17750-17799	KIT DE RETENES TAPA DEL CIGÜENAL DE CONTRARROTACIÓN Retenes de la tapa del cigüeñal diseñados para motores de rotación opuesta a la normal. (Retenes de rotación normal incluidos en el set de conversión).	REVERSE ROTATION TIMING COVER SEAL SETS SERIES Timing cover seals designed to seal crankshaft which rotates in the opposite direction from normal (standard rotation seal is included in Conversion set and Timing cover set)	PARAOLIO CARTER DISTRIBUZIONE CONTROTOTANTI Guarnizioni del coperchio dell'albero a gomiti progettate per motori controrotanti (le guarnizioni per la rotazione normale sono incluse nel set di conversione).	KIT DE JOINTS DE COUVERCLE DE VILEBREQUIN CONTRE-ROTATIF Joints de couvercle de vilebrequin conçus pour les moteurs à contre-rotation (joints à rotation normale inclus dans le kit de conversion).
17900-17949	KIT DE TAPA VÁLVULA Todas las juntas de las tapas de las válvulas para sellar el motor.	VALVE COVER SET SERIES All valve cover or push rod cover gaskets (and grommets if required) required to seal one engine.	KIT COPERCHIO PUNTERIE Tutte le guarnizioni del coperchio della valvola per sigillare il motore.	KIT DE COUVERCLE DE SOUPAPE Tous les joints de couvercle de soupape pour l'étanchéité du moteur.
17950-17999	KIT DE CÁRTER Todas las juntas y retenes del cárter de aceite, o la junta del cárter de aceite de goma moldeada de una pieza, necesarias para sellar un motor.	OIL PAN SETS SERIES All oil pan gaskets & seals, or one-piece molded rubber oil pan gasket, required to seal one engine.	GUARNIZIONE COPPA DELL'OLIO Tutte le guarnizioni e le tenute della coppa dell'olio, o la guarnizione in gomma stampata in un unico pezzo, necessarie per sigillare un motore.	KIT DE CARTER D'HUILE Tous les joints de carter d'huile, ou un joint de carter d'huile en caoutchouc moulé d'une seule pièce, nécessaires à l'étanchéité d'un moteur.

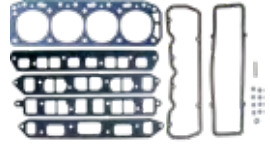





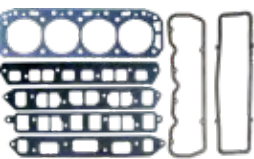
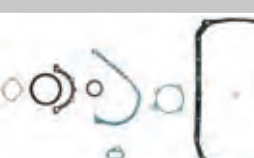

## 120 / 205L (120 HP)

REF	CULATA	CYLINDER HEAD	TESTATA	CULASSE
	REC17000 JUNTA CULATA	CYLINDER HEAD	GUARNIZIONE TESTATA	JOINT DE CULASSE
	REC17200 KIT JUNTAS SUPERIOR	GASKET HEAD SET	KIT PARTE ALTA	KIT DE JOINTS SUPÉRIEURS
REF	INFERIOR	CONVERSION	PARTE BASSA	PARTIE BASSE
	REC17100 KIT JUNTAS INFERIOR (2361802+) Retén 2 piezas, 4 piezas junta cárter.	CONVERSION GASKET SET (2361802+) 2 piece rear main bearing seal & 4 piece oil pan gasket	KIT PARTE BASSA (2361802+) Paraolio in 2 px, 4 pz guarnizione coppa dell'olio.	KIT DE JOINTS INFÉRIEURS (2361802+) Joint d'huile 2 pièces, joint de carter 4 pièces.
REF	COLECTOR ADMISIÓN-ESCAPE	MANIFOLD INTAKE & EXHAUST	COLLETTORE ASPIRAZIONE-SCARICO	COLLECTEUR ADMISION ET ÉCHAPPEMENT
	REC27-52546 Junta admisión-escape (1666601 - 6229717)	Intake-Exhaust gasket (1666601 - 6229717)	Guarnizione aspirazione - scarico (1666601 - 6229717)	Joint admision et échappement (1666601 - 6229717)



	REC27-96429	Junta admisión-escape (6229718+)	Intake-Exhaust gasket (6229718+)	Guarnizione aspirazione - scarico (6229718+)	Joint admision et échappement (6229718+)
	REF	CARTER	OIL PAN	COPPA DELL'OLIO	CARTER
	REC17950	KIT JUNTAS CARTER Retén trasero dos piezas, 4 piezas junta cárter.	GASKET OIL PAN SET Two piece rear main bearing seal & 4 piece oil pan gasket	KIT GUARNIZIONE Paraolio posteriore in 2, guarnizione coppa in 4 pz.	KIT DE JOINTS CARTER Joint arrière en deux parties, Joint de carter 4 pièces.
	REF	TAPA VÁLVULAS	VALVE COVER	COPERCHIO VALVOLE	COUVERCLE
	REC17900	Junta	Gasket	Guarnizione	Joint
	REF	TAPA EMPUJADORES	PUSH ROD COVER	COPERCHIO ASTE PUNTERIE	COUVERCLE
	REC17903	Junta	Gasket	Guarnizione	Joint







### 140 / 3.0L, 140 / 3.0LX (115,130, 135, 140 HP)

	REF	CULATA	CYLINDER HEAD	TESTATA	CULASSE
	REC17000	JUNTA CULATA	CYLINDER HEAD	GUARNIZIONE TESTATA	JOINT DE CULASSE
	REC17200	KIT JUNTAS SUPERIOR	GASKET HEAD SET	KIT PARTE ALTA	KIT DE JOINTS SUPÉRIEURS
	REF	INFERIOR	CONVERSION	PARTE BASSA	PARTIE BASSE
	REC17102	KIT JUNTAS Retén 1 pieza. Junta cárter 1 pieza.	GASKET SET 1 piece rear main bearing seal 1 piece oil pan gasket	KIT Paraolio in 1 pz. Guarnizione coppa dell'olio in 1 pz.	KIT JOINTS INFÉRIEURS Joint spi 1 pièce. Joint de carter 1 pièce.
	REC17100	KIT JUNTAS INFERIOR (2361802+) Retén 2 piezas, 4 piezas junta cárter.	CONVERSION GASKET SET (2361802+) 2 piece rear main bearing seal & 4 piece oil pan gasket	KIT PARTE BASSA (2361802+) Paraolio in 2 pz, 4 pz guarnizione coppa dell'olio.	KIT PARTIE INFÉRIEURE (2361802+) Joint d'huile 2 pcs, 4 pièces de joint de carter.
	REF	COLECTOR ADMISIÓN-ESCAPE	MANIFOLD INTAKE & EXHAUST	COLLECTORE ASPIRAZIONE-SCARICO	COLLECTEUR ADMISION ET ÉCHAPPEMENT
	REC27-96429	Junta (6229718+) excepto 3.0 LX	Gasket (6229718+) excl. 3.0 LX	Guarnizione (6229718+) eccetto 3.0 LX	Joint (6229718+) sauf 3.0 LX seulement
	REC27-815528	Junta (6229718+) sólo 3.0 LX	Gasket (6229718+) only 3.0 LX	Guarnizione (6229718+) solo 3.0 LX	Joint (6229718+) 3.0 LX uniquement
	REC27-53354	Junta (-9229717)	Gasket (-9229717)	Guarnizione (9229717)	Joint (-9229717)
	REF	CARTER	OIL PAN	COPPA DELL'OLIO	CARTER
	REC17950	KIT JUNTAS Retén trasero dos piezas, 4 piezas junta cárter.	GASKET SET Two piece rear main bearing seal & 4 piece oil pan gasket	KIT GUARNIZIONE Paraolio posteriore in 2, guarnizione coppa in 4 pz.	KIT DE JOINTS Joint arrière en deux parties, Joint de carter 4 pièces.
	REF	TAPA VÁLVULAS	VALVE COVER	COPERCHIO VALVOLE	COUVERCLE SOUPAPES
	REC17900	Junta	Gasket	Guarnizione	Joint
	REF	TAPA EMPUJADORES	PUSH ROD COVER	COPERCHIO ASTE PUNTERIE	COUVERCLE
	REC17903	Junta	Gasket	Guarnizione	Joint

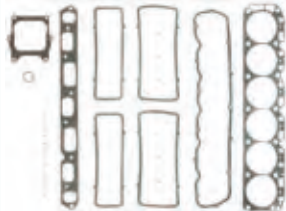

### 165, 170, 180, 190, 470, 485, 488









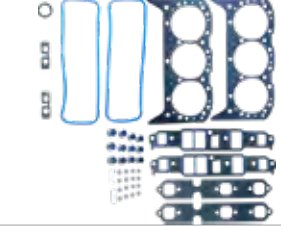
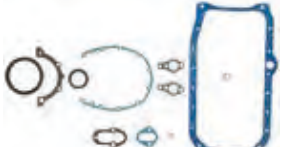

	REF	CULATA	CYLINDER HEAD	TESTATA	CULASSE
	FEL17069	JUNTA CULATA	CYLINDER HEAD	GUARNIZIONE TESTATA	JOINT DE CULASSE

160 HP, 165 HP (2770032 - 6916778)

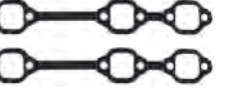

REF	CULATA	CYLINDER HEAD	TESTATA	CULASSE	
	FEL17019	JUNTA CULATA	CYLINDER HEAD	GUARNIZIONE TESTATA	JOINT DE CULASSE
	FEL17219	KIT JUNTAS SUPERIOR SIN juntas colector escape-admisión	GASKET HEAD SET WITHOUT Intake & Exhaust manifold gasket not included	KIT PARTE ALTA SENZA guarnizioni collettore scarico- aspirazione	KIT JOINTS SUPÉRIEUR SANS joints de collecteur d'échappement - admission
REF	INFERIOR	CONVERSION	PARTE BASSA	PARTIE BASSE	
	FEL17119	KIT JUNTAS INFERIOR Solo cárter 24 tornillos	CONVERSION GASKET SET 24 bolt oil pan only	KIT PARTE BASSA Solo coppa con 24 viti.	KIT JOINTS INFÉRIEUR Seulement carter avec 24 vis
REF	COLECTOR ADMISIÓN-ESCAPE	MANIFOLD INTAKE & EXHAUST	COLLETTORE ASPIRAZIONE-SCARICO	COLLECTEUR ADMISION ET ÉCHAPPEMENT	
	FEL17302	Junta	Gasket	Guarnizione	Joint
REF	CARTER	OIL PAN	COPPA DELL'OLIO	CARTER	
	FEL17975	KIT JUNTAS Solo cárter 24 tornillos	GASKET SET 24 bolt oil pan only	KIT GUARNIZIONE Solo coppa con 24 viti.	KIT DE JOINTS Seulement carter avec 24 vis
REF	TAPA VÁLVULAS	VALVE COVER	COPERCHIO VALVOLE	COUVERCLE SOUPAPES	
	FEL17925	Junta	Gasket	Guarnizione	Joint
REF	TAPA EMPUJADORES	PUSH ROD COVER	COPERCHIO ASTE PUNTERIE	COUVERCLE	
	FEL17926	Junta	Gasket	Guarnizione	Joint

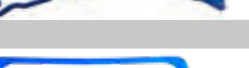

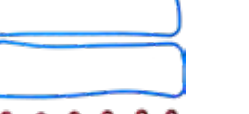
4.3L: 155, 175 HP • 4.3LX: 175, 180, 205 HP • 175 & 185 HP 2 BBL. • 205 HP 4 BBL

REF	CULATA	CYLINDER HEAD	TESTATA	CULASSE	
	REC17010	Se necesitan dos	2 required	Necessarie 2	Deux sont nécessaires
	REC17210	Motor sin eje equilibrado. Incluye juntas tapa válvulas y retenes.	Engine without balance shaft. Valve cover gaskets and premium valve stem seals included.	Motore senza asse bilanciato. Include guarnizione coperchio punterie e paraoli valvole.	Moteur sans arbre d'équilibrage. Comprend les joints de cache culbuteur et les joints d'étanchéité.
	REC17211	Motor con eje equilibrado. Incluye juntas tapa válu- las y retenes.	Engine with balance shaft. Valve cover gaskets and premium valve stem seals included.	Motore con asse bilanciato. Include guarnizione coperchio punterie e paraoli valvole.	Moteur avec arbre d'équilibrage. Comprend les joints de cache culbuteur et les joints d'étanchéité.
REF	INFERIOR	CONVERSION	PARTE BASSA	PARTIE BASSE	
	REC17115	KIT JUNTAS INFERIOR Motor sin eje equilibrado con retén de una pieza y 1 pieza junta cárter. Incluye Junta de cárter.	CONVERSION GASKET SET Engine without balance shaft with one-piece rear main bearing seal & 1 piece oil pan gasket; oil pan gasket incl.	KIT PARTE BASSA Motore senza asse bilanciato. Paraolio post in 1 pz e guarnizione coppa in 1 pz. Include la guarnizione del carter.	KIT DE JOINTS INFÉRIEURS Moteur équilibré sans arbre, avec joint d'huile en une pièce et joint de carter en une pièce, y compris le joint de carter.



	REC17110	KIT JUNTAS INFERIOR Motor sin eje equilibrado con retén de 2 piezas y 4 piezas junta cárter. Incluye Junta de cárter.	CONVERSION GASKET SET Engine without balance shaft with 2 piece rear main bearing seal & 4 pieces oil pan gasket; oil pan gasket incl.	KIT PARTE BASSA Motore senza asse bilanciato. Paraolio post in 2 pz e guarnizione coppa in 4 pz. Include la guarnizione del carter.	KIT DE JOINTS INFÉRIEURS Moteur équilibré sans arbre avec joint d'huile 2 pièces et joint de carter 4 pièces. Comprend un joint de carter.
	REC17116	KIT JUNTAS INFERIOR Motor con eje equilibrado con retén de 1 pieza y 1 pieza junta cárter. Incluye Junta de cárter.	CONVERSION GASKET SET Engine without balance shaft with one-piece rear main bearing seal & 1 piece oil pan gasket; oil pan gasket incl.	KIT PARTE BASSA Motore con asse bilanciato. Paraolio post in 1 pz e guarnizione coppa in 1 pz. Include la guarnizione del carter.	KIT DE JOINTS INFÉRIEURS Moteur avec arbre équilibré avec joint d'arbre 1 pièce et joint de carter 1 pièce. Comprend un joint de carter.
	REF	COLECTOR ADMISION-ESCAPE	MANIFOLD INTAKE & EXHAUST	COLLETTORE ASPIRAZIONE-SCARICO	COLLECTEUR ADMISSION ET ECHAPPEMENT
	REC17310	Junta Admisión-Escape	Intake-Exhaust Gasket	Guarnizione aspirazione	Joint d'admission et d'échappement
	REC824326002	Junta Admisión Vortec (2 unid.)	Intake Gasket Vortec (2 units)	guarnizione aspirazione Vortec (2 unità)	Joint d'admission Vortec (2 pièces)
	REC27-99757	Kit juntas colector - escape	Exhaust gasket set	Kit guarnizione scarico	Kit joints collecteur d'échappement
	REF	CARTER	OIL PAN	COPPA DELL'OLIO	CARTER
	REC17970	KIT JUNTAS CARTER 4 piezas junta cárter. (Retén 2 piezas)	GASKET OIL PAN SET 4 piece oil pan gasket (2 piece Seal)	KIT GUARNIZIONE Guarnizione coppa in 4 pz. (paraolio 2 pz)	KIT JOINTS 4 pièces carter.
	REC17971	1 junta carter (Retén 1 pieza)	1 piece oil pan gasket (1 piece seal)	Guarnizione coppa in 1 pz (paraolio 1 pz)	1 joint carter (Joint d'huile 1 pièce)
	REC27-142471	1 Junta Carter de goma (-2008)	1 rubber oil pan gasket (-2008)	Guarnizione 1 pz (-2008)	1 Joint de carter en caoutchouc (-2008)
	REC21124852	1 Junta Carter de goma (2008+)	1 rubber oil pan gasket (2008+)	Guarnizione 1 pz (2008+)	1 Joint de carter en caoutchouc (2008+)
	REF	TAPA VÁLVULAS	VALVE COVER	COPERCHIO VALVOLE	COUVERCLE SOUPAPES
	REC17920	Motor sin eje equilibrado.	Engine without balance shaft	Motore senza asse equilibrato.	Moteur sans arbre équilibré.
	REC17921	Motor con eje equilibrado.	Engine with balance shaft	Motore con asse equilibrato.	Moteur avec arbre équilibré

### 5.0L: 215 HP, 225 HP , 888 (198 HP) FORD





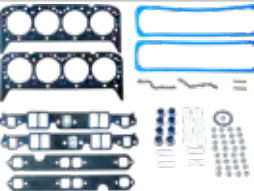
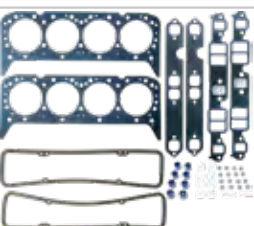



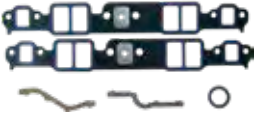

REF	CULATA	CYLINDER HEAD	TESTATA	CULASSE	
	FEL17060	JUNTA CULATA Se necesitan dos	CYLINDER HEAD 2 required	GUARNIZIONE TESTATA Necessarie 2	JOINT DE CULASSE Deux sont nécessaires
	FEL17260	KIT JUNTAS SUPERIOR Incluye retenes válvulas.	GASKET HEAD SET Premium valve stem seals incl.	KIT PARTE ALTA include paraoli valvole	KIT DE JOINTS SUPÉRIEURS Comprend les joints de valve.

REF	INFERIOR	CONVERSION	PARTE BASSA	PARTIE BASSE
	FEL17160	KIT JUNTAS	CONVERSION GASKET SET	KIT GUARNIZIONE KIT JOINTS
REF	COLECTOR ADMISION-ESCAPE	MANIFOLD INTAKE & EXHAUST	COLLETORE ASPIRAZIONE-SCARICO	COLLECTEUR ADMISION ET ECHAPPEMENT
	FEL17360	KIT JUNTAS ADMISION-ESCAPE	INTAKE-EXHAUST GASKET SET	KIT GUARNIZIONI ASPIRAZIONE - SCARICO KIT JOINTS ADMISION - ECHAPPEMENT
	REC3852455	JUNTA COLECTOR -ESCAPE	OIL PAN - EXHAUST GASKET	GUARNIZIONE COPPA OLIO - SCARICO JOINT COLLECTEUR D'ECHAPPEMENT
REF	CARTER	OIL PAN	COPPA DELL'OLIO	CARTER
	FEL17995	Retén 2 piezas	2 pieces seal	Paraolio 2 pz Joint spi 2 pièces
REF	TAPA VÁLVULAS	VALVE COVER	COPERCHIO VALVOLE	COUVERCLE SOUPAPES
	FEL17945	Con tapa de válvulas de acero	With iron valve cover	Con coperchio valvole in acciaio Cache culbuteur en acier



**5.0L: 180, 190, 200, 228, 230 HP  
5.0LX: 205, 230 HP; 198/888 (198HP)**









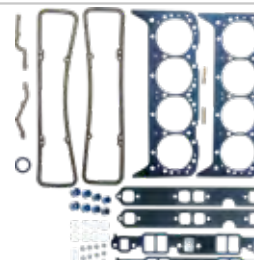

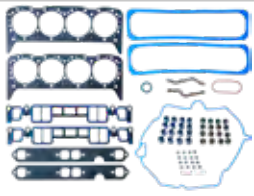

REF	CULATA	CYLINDER HEAD	TESTATA	CULASSE
	REC17020	Se necesitan dos	2 required	Ne servono 2 2 sont nécessaires
	REC17224	Tornillo centro tapa válvulas. Incluye retenes válvulas.	With center bolt desing valve covers. Premium valve stem seals included.	Viti coperchio punterie al centro. Include paraoli valvole. Cache culbuteur avec les vis centrales. Comprend les joints de queue de soupapes.
	REC17220	Tornillo en el lateral tapa válvulas. Incluye retenes válvulas.	Rim bolt desing valve covers. Premium valve stem seals included.	Viti coperchio punterie nel perimetro. Include paraoli valvole. Cache culbuteur avec les vis laterales. Comprend les joints de queue de soupapes.
REF	INFERIOR	CONVERSION	PARTE BASSA	PARTIE BASSE
	REC17125	Retén de 1 pieza y junta cárter de 1 pieza. Incluye junta de cárter.	One-piece rear main bearing seal & 1 piece oil pan gasket. Oil pan gasket included.	Paraolio in 1 peze e guarnizione coppa in 1 peze. Include paraolio coppa. Joint spi 1 pièce. Joint de carter 1 pièce. Comprend le Joint spi.
	REC17120	Retén de 2 piezas y junta cárter de 4 piezas	Two-piece rear main bearing seal & 4 pieces oil pan gasket.	Paraolio in 2 peze e guarnizione coppa in 4 pezi. Joint spi 2 pièces et joint de carter 4 pièces.

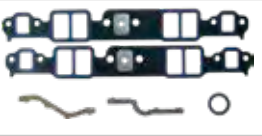

REF	COLECTOR ADMISIÓN-ESCAPE	MANIFOLD INTAKE & EXHAUST	COLLETTORE ASPIRAZIONE-SCARICO	COLLECTEUR ADMISION ET ÉCHAPPEMENT
 REC17320	Kit junta admisión-escape.	Intake-exhaust gasket set.	Kit guarnizioni aspirazione - scarico.	Kit joints d'admission.
 REC27-807473A1	JUNTA ADMISIÓN Vortec (2 unid.) Junta de plástico.	INTAKE GASKET Vortec (2 units). Gasket in plastic.	GUARNIZIONE ASPIRAZIONE Vortec necessita 2 pz. Guarnizione in plastica	JOINT ADMISION Vortec (2 unités). Joint en plastique.
 REC27-33395	Kit juntas colector escape	Oil pan - exhaust gasket set.	Kit guarnizione Coppa olio - scarico.	Kit joints collecteur d'échappement.
REF	CARTER	OIL PAN	COPPA DELL'OLIO	CARTER
 REC17982	Junta cárter 1 pieza. Junta de cárter incluida.	1 piece oil pan gasket. Molded rubber oil pan gasket included.	Guarnizione in 1 pz. Guarnizione coppa included.	Joint de carter 1 pièce.
 FEL17983	Junta 1 pieza. Para motores con retén trasero de 2 piezas.	1 piece molded rubber gasket for engines with Two-piece rear main bearing sea.	Guarnizione in 1 pz, paraolio posteriore in 2 pz.	Joint de carter 1 pièce pour moteurs avec Joint spi arrière 2 pièces.
 REC17980	Varilla aceite de BABOR con retén trasero de 2 piezas y junta cárter de 4 piezas.	PORT dipstick with 2-piece rear main bearing seal & 4-piece oil pan gasket.	Asticella olio a SINISTRO con paraolio posteriore in 2 pz. e guarnizione coppa da 4 pz.	Jauge d'huile à BABORD avec Joint spi arrière en 2 pièces et joint de carter en 4 pièces.
 REC17981	Varilla aceite de ESTRIBOR con retén trasero de 2 piezas y junta cárter de 4 piezas.	STARBOARD dipstick with 2-piece rear main bearing seal & 4-piece oil pan gasket	Asticella olio DESTRO con paraolio posteriore in 2 pz e guarnizione coppa da 4 pz.	Jauge d'huile à TRIBORD avec Joint spi arrière en 2 pièces et joint de carter en 4 pièces.
REF	RETÉN TRASERO CIGÜEÑAL	CRANKSHAFT REAR SEAL	PARAOLIO POSTERIORE ALBERO MOTORE	JOINT ARRIÈRE DE VILEBREQUIN
 FEL17725	Retén partido. Contrarrotación. De goma; dos piezas.	Split seal Rev. rotation, rubber; two-piece	Controrotazione in 2 pz. in gomma.	Joint contre-rotation en 2 pièces, en caoutchouc.
REF	TAPA VÁLVULAS	VALVE COVER	COPERCHIO VALVOLE	COUVERCLE SOUPAPE
 REC17931	Tornillo centro tapa válvulas con juntas.	Molded rubber gaskets incl.	Coperchio punterie con viti centrali.	Fixation par vis centrale
 REC17930	Tornillo en el canto.	Rim bolt desing	Coperchio punterie con viti nel perimetro.	Fixation par 4 vis laterales.

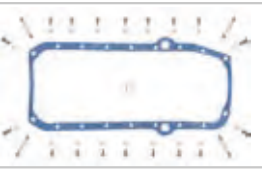





**BLACK SCORPION (315 HP) 5.7L: 230, 235, 260 HP • 5.7L BLUE WATER INBOARD 250, 260 HP  
5.7L BRAVO, 240, 250, 270 HP • 5.7L COMP SKI, 250, 260 HP, 255 HP, 300, 300 MR/TR  
350 MAGNUM, 350 MAGNUM TOURNAMENT SKI (240, 250, 265, 270 HP)**

REF	CULATA	CYLINDER HEAD	TESTATA	CULASSE
 REC17030	Se necesitan dos	2 required	Ne servono 2	2 sont nécessaires
 REC17214	Tornillo centro tapa válvulas. Incluye retenes válvulas.	With center bolt desing valve covers. Premium valve stem seals included.	Viti coperchio punterie al centro. Include paraoli valvole.	Cache culbuteur avec les vis centrales. Comprend les joints de queue de soupapes.
 REC17230	Tornillo en el lateral tapa válvulas. Incluye retenes válvulas.	Rim bolt desing valve covers. Premium valve stem seals included.	Viti coperchio punterie nel perimetro. Include paraoli valvole.	Cache culbuteur avec les vis laterales. Comprend les joints de queue de soupapes.

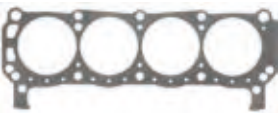

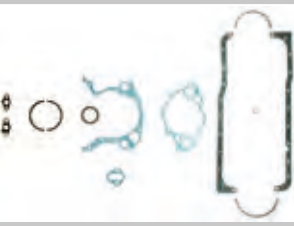





	REC17232	Juntas del colector admisión de plástico. Retenes válvulas incluidos.	Gasket head set with plastic intake manifold gaskets. Premium valve stem. Seals incl.	Kit con guarnizione aspirazione in plastica. Paraoli valvole inclusi.	Kit joint collecteur aspiration de plastique. Comprend les joints de queue de soupapes.
REF	INFERIOR	CONVERSION	PARTE BASSA	PARTIE BASSE	
	REC17125	Retén de 1 pieza y junta cárter de 1 pieza Incluye junta de cárter.	One-piece rear main bearing seal & 1 piece oil pan gasket. Oil pan gasket included.	Paraolio in 1 peze e guarnizione coppa in 1 peze. Include paraolio coppa.	Joint spi 1 pièce. Joint de carter 1 pièce. Comprend le Joint spi.
	FEL17124	Con tapa de distribución de plástico, retén de 1 pieza y junta cárter de 1 pieza.	Engine with plastic timing cover, with 1 piece bearing seal & 1 piece oil pan gasket.	Cárter distribuzione in plastica, paraolio in 1 pz e guarnizione coppa olio in 1 pz.	Pour carter de distribution en plastique, joint arrière monobloc et joint de carter monobloc. Joint de carter inclus.
	REC17120	Retén de 2 piezas y junta cárter de 4 piezas	Two-piece rear main bearing seal & 4 pieces oil pan gasket.	Paraolio in 2 peze e guarnizione coppa in 4 pezi.	Joint spi 2 pièces et joint de carter 4 pièces.
REF	COLECTOR ADMISION-ESCAPE	MANIFOLD INTAKE & EXHAUST	COLLETORE ASPIRAZIONE-SCARICO	COLLECTEUR ADMISSION ET ECHAPPEMENT	
	REC17320	Kit Juntas Admisión-Escape	Intake-Exhaust Gasket Set	Kit guarnizioni aspirazione - SCARICO	Kit joints d'admission
	REC27-807473A1	JUNTA ADMISION Vortec (2 unid.) Junta de plástico.	INTAKE GASKET Vortec (2 units) Gasket in plastic.	GUARNIZIONE Vortec necessita 2 pz guarnizione in plastica	JOINT ADMISSION Vortec (2 pièces). Joint en plastique.
	FEL17420	Kit juntas colector -escape	Oil pan - Exhaust gasket set	Kit guarnizione coppa olio - SCARICO	Kit joints collecteur-d'échappement
REF	CARTER	OIL PAN	COPPA DELL'OLIO	CARTER	
	REC17982	Junta cárter 1 pieza. Incluye Junta de cárter.	1 piece oil pan gasket. Molded rubber oil pan gasket included.	Guarnizione in 1 pz. Include guarnizione coppa.	Joint de carter 1 pièce. Comprend joint de carter.
	FEL17983	1 pieza junta para motores con retén trasero de 2 piezas.	1 piece molded rubber gasket for engines with 2-piece rear main bearing seal.	Guarnizione in 1 pz, paraolio posteriore in 2 px.	Joint 1 pièce pour moteurs avec Joint spi arrière 2 pièces.
	REC17980	Varilla aceite de BABOR con retén trasero de 2 piezas y junta cárter de 4 piezas.	PORT dipstick with 2-piece rear main bearing seal & 4-piece oil pan gasket.	Asticella olio a SINISTRO con paraolio posteriore in 2 pz. e guarnizione coppa da 4 pz.	Jauge d'huile à BABORD avec Joint spi arrière en 2 pièces et joint de carter en 4 pièces.
	REC17981	Varilla aceite de ESTRIBOR con retén trasero de 2 piezas y junta cárter de 4 piezas.	STARBOARD dipstick with 2-piece rear main bearing seal & 4-piece oil pan gasket	Asticella olio DESTRO con paraolio posteriore in 2 pz e guarnizione coppa da 4 pz.	Jauge d'huile à TRIBORD avec Joint spi arrière en 2 pièces et joint de carter en 4 pièces.
REF	RETÉN TRASERO CIGÜEÑAL	Crankshaft rear seal	PARAOLIO POSTERIORE ALBERO MOTORE	JOINT D'HUILE DE VILEBREQUIN ARRIERE	
	FEL17725	Retén partido. Contrarrotación. De goma; dos piezas.	Split seal Rev. rotation, rubber; two-piece	Controrotazione in 2 pz. in gomma.	Joint en caoutchouc en 2 pièces pour moteur en contre rotation.

	REF	TAPA VÁLVULAS	VALVE COVER	COPERCHIO VALVOLE	COUVERCLE DE SOUPE
	REC17931	Tornillo centro tapa válvulas con juntas.	Molded rubber gaskets incl.	Coperchio punterie con viti centrali.	Cache culbuteur avec vis centrales.
	REC17930	Tornillo en el canto.	Rim bolt desing	Coperchio punterie con viti nel perimetro.	Cache culbuteur avec vis latérales.
	REF	RETÉN DISTRIBUCIÓN	OIL SEAL TIMING COVER	PARAOLIO DISTRIBUZIONE	JOINT D'HUILE DE DISTRIBUTION
	REC3853341	Reten contrarotación Motor sin tapa distribución de plástico.	Reverse rotation oil seal Engines w/o plastic timing cover.	Paraolio controrotante. Motore senza carter distribuzione in plastica.	Joint de contre-rotation du moteur sans cache-souape en plastique.

**5.8L 233 (3258728 - 4175499) (233 HP)  
255 (3258728 - 4175499) (255 HP)  
FORD**

	REF	CULATA	CYLINDER HEAD	TESTATA	CULASSE
	FEL17060	Se necesitan dos.	2 required.	Ne servono 2.	2 sont nécessaires.
	FEL17260	Con retenes valvula.	Premium valve stem.	Include paraolio valvole.	Comprend les joints de queue de soupapes.
	REF	INFERIOR	CONVERSION	PARTE BASSA	PARTIE BASSE
	FEL17165	Retén 2 piezas, 4 piezas junta cárter.	2 piece rear main bearing seal Et 4 piece oil pan gasket,	Paraolio in 2 pz, 4 pz guarnizione coppa dell'olio.	KIT JOINTS
	REF	COLECTOR ADMISIÓN-ESCAPE	MANIFOLD INTAKE & EXHAUST	COLLETORE ASPIRAZIONE-SCARICO	COLLECTEUR ADMISSION ET ÉCHAPPEMENT
	FEL17360	Kit Juntas Admisión.	Intake gasket set.	Kit guarnizioni aspirazione	Kit joints admission
	REC3852455	Junta escape.	Exhaust gasket.	Guarnizione scarico.	Joints de collecteur d'échappement.
	REF	CARTER	OIL PAN	COPPA DELL'OLIO	CARTER
	FEL17996	Cárter 4 piezas.	4 piece oil pan gasket.	4 pz coppa.	Joint de carter en 4 pièces.
	REF	TAPA VÁLVULAS	VALVE COVER	COPERCHIO VALVOLE	COUVERCLE
	FEL17945	Con tapa de válvulas de acero	With iron valve cover	Con coperchio valvole in acciaio	Cache culbuteur en acier

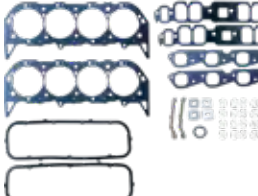

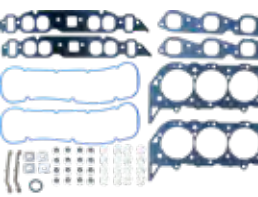







7.4L 454 V8: 420 HP GEN IV & V • 425 (385, 400, 425 HP GEN IV & V) • 525 SC (500 HP GEN V)  
 7.4L BLUE WATER INBOARD (-D715493) (310, 340 HP GEN IV)  
 7.4L BLUE WATER INBOARD (D715494+) (310 HP GEN V)  
 7.4L BRAVO (-D603117) (300, 330 HP GEN. IV)  
 7.4L BRAVO I (D603118+) (300, 330 HP GEN V)  
 7.4L BRAVO II (D603118+) (300, 330 HP GEN V)  
 7.4L BRAVO III (D603118+) (3350 HP GEN V)  
 7.4L EFI (F215800+) (310 HP GEN V), 330, 340, 350, 370TRS, • 400 TRS GEN IV, 450 HP GENE V  
 454 MAGNUM ALPHA (A631894 - B785148) (330 HP GEN IV)  
 454 MAGNUM BRAVO (B721206 - D805068) (350, 365 HP GENE IV)  
 454 MAGNUM BRAVO (D805069+) (350 HP GENE V)

	REF	CULATA	CYLINDER HEAD	TESTATA	CULASSE
	REC17040	Gen IV exc. H.O. Se necesitan dos	Gen IV exc. H.O. 2 required	Gen IV escluso H.O. Necessarie 2	Gen IV exc. H.O. Deux sont nécessaires.
	FEL17049	JUNTA CULATA Gene IV sólo H.O. super medida. Se necesitan 2.	CYLINDER HEAD Gene IV H.O. only super bore 2 required	GUARNIZIONE TESTATA Gene IV solo H.O. maggiorata. Necessarie 2	JOINT DE CULASSE Gene IV seulement H.O. super taille. 2 sont nécessaires.
	REC17046	JUNTA CULATA Gene IV sólo H.O. Se necesitan 2.	CYLINDER HEAD Gene IV H.O. only 2 required	GUARNIZIONE TESTATA Gene IV solo H.O. Necessarie 2	JOINT DE CULASSE Gene IV seulement H.O. 2 sont nécessaires.
	REC17042	Gen IV & V. Se necesitan 2.	Gen IV & V. 2 required	Gen IV e V. Necessarie 2	Gen IV et V. Deux sont nécessaires.
	REC17240	Gen IV exc. H.O. con admisión ovalada. Se incluye retenes de válvula.	Gen IV exc. H.O. with oval intake ports. Premium valve stem seals included.	Gen IV escluso H.O. con aspirazione ovale. Inclusi paraoli valvole.	Gen IV exc. H.O. avec admission ovale. Joints de queue de soupape inclus.
	REC17241	KIT JUNTAS SUPERIOR Gene IV exc. H.O. con admisión rectangular. Se incluye retenes de válvula	GASKET HEAD SET Gen IV exc. H.O. w/ rectangular intake ports; premium valve stem seals incl.	KIT PARTE ALTA Gene IV escluso H.O. con aspirazione rettangolare. Inclusi paraoli valvole.	KIT DE JOINTS SUPÉRIEURS Gene IV exc. H.O. avec admission rectangulaire. Joints de soupape inclus
	REC17246	KIT JUNTAS SUPERIOR Gene V sólo H.O. con admisión rectangular. Se incluye retenes de válvula	GASKET HEAD SET Gen IV only H.O. w/ rectangular intake ports; premium valve stem seals incl.	KIT PARTE ALTA Gene IV solo H.O. con aspirazione rettangolare. Inclusi paraoli valvole.	KIT DE JOINTS SUPÉRIEURS Gene IV uniquement H.O. avec admission rectangulaire. Joints de soupape inclus
	REC17242	KIT JUNTAS SUPERIOR Gene V & VI H.O. con admisión ovalada. Se incluye retenes de válvula.	GASKET HEAD SET Gen V & VI or H.O. w/oval intake ports; premium valve stem seals incl.	KIT PARTE ALTA Gene V e VI H.O. con aspirazione ovale. Include paraoli valvole.	KIT DE JOINTS SUPÉRIEURS Gene V et VI et H.O. avec admission ovale. Joints de soupape inclus.
	REC17243	Gen V & VI solo H.O. con admisión rectangular, juntas tapa válvulas y retenes incluidos.	Gen V & VI, H.O. only, with rectangular intake ports valve cover gaskets and premium valve stem seals incl.	Gen V e VI solo H.O. con aspirazione rettangolare, guarnizione coperchio punterie e paraoli inclusi.	Gen V et VI H.O. uniquement avec admission rectangulaire, joints de cache culbuteur et joints de queue de soupape inclus.

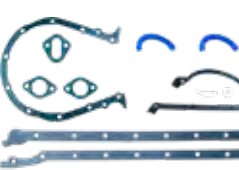

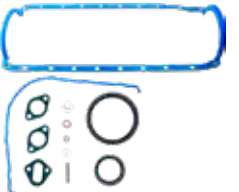
	FEL17205	Gen VI sólo EFI Juntas de tapa válvulas y retenes incluidos.	Gen VI, EFI only, valve cover gaskets and premium valve stem seals incl.	Gen VI, solo EFI guarnizione rettangolare, guarnizione coperchio punterie e paraoli inclusi.	Gen V EFI uniquement. Joints de cache culbuteur et joints de queue de soupape inclus.
	REF	INFERIOR	CONVERSION	PARTE BASSA	PARTIE INFÉRIEUR
	REC17140	Gene IV con retén trasero de dos piezas y junta cárter de 4 piezas.	Gene IV w/two piece rear main bearing seal & four piece oil pan gasket.	Gene IV con paraolio posteriore in 2 pz. e guarnizione coppa dell'olio in 4 pz.	Gene IV avec joint arrière en deux parties et joint de carter en 4 parties.
	FEL17145	Gene V con retén trasero de una pieza y junta cárter incluida.	Gene V w/one piece rear main bearing seal & one piece oil pan gasket. oil pan gasket. incl.	Gene V con paraolio posteriore in 1 pz. e guarnizione coppa dell'olio in 1 pz.	Gene V avec joint arrière monobloc et joint de carter monobloc. Joint de carter inclus.
	REC17146	Gene VI con retén trasero de una pieza y junta cárter incluida.	Gene VI w/one piece rear main bearing seal & one piece oil pan gasket. oil pan gasket. incl.	Gene VI con paraolio posteriore in 1 pz. e guarnizione coppa dell'olio in gomma in 1 pz.	Gene VI avec joint à lèvres arrière en une seule pièce et joint de carter en une seule pièce. Joint de carter inclus.
	REF	COLECTOR ADMISION-ESCAPE	MANIFOLD INTAKE & EXHAUST	COLLETTORE ASPIRAZIONE-SCARICO	COLLECTEUR ADMISION ET ECHAPPEMENT
	REC17341	KIT JUNTA ADMISION Gene IV, V y VI sólo H.O. con admisión rectangular. Gene IV, excl. H.O. con admisión rectangular.	INTAKE GASKET SET Gene IV, V & VI, H.O. only w/rectangular intake ports Gene IV excl. H.O. w/rect. intake ports	KIT GUARNIZIONI ASPIRAZIONE Gene IV, V e VI sólo H.O. con aspirazione rettangolare Gene IV escluso H.O. con aspirazione rettangolare	KIT DE JOINTS D'ADMISSION Gènes IV, V et VI uniquement H.O. avec admission rectangulaire. Gene IV, excl. H.O. avec admission rectangulaire.
	REC17340	KIT JUNTA ADMISION Gene IV, excl. H.O. con admisión oval. Gene V y VI exc. EFI y H.O. con admisión ovalada.	INTAKE GASKET SET Gene IV excl. H.O. w/oval intake ports Gene V & VI, excl. EFI & H.O. w/oval intake ports	KIT GUARNIZIONI ASPIRAZIONE Gene IV escluso H.O. con aspirazione ovale. Gene V e VI escluso EFI e H.O. con aspirazione ovale	KIT DE JOINTS D'ADMISSION Gene IV, excl. H.O. avec prise ovale. Gène V et VI exc. EFI et H.O. avec admission ovale.
	REC17342	KIT JUNTA ADMISION Gene V y VI sólo EFI	INTAKE GASKET SET Gene V & VI, EFI only	KIT GUARNIZIONI ASPIRAZIONE Gene V e VI, solo EFI	KIT DE JOINTS D'ADMISSION Gene V et VI EFI uniquement
	REC27-46820	KIT JUNTA ESCAPE Gene IV, V y VI.	EXHAUST GASKET SET Gene IV, V & VI	KIT GUARNIZIONI SCARICO Gene IV, V e VI	KIT DE JOINTS D'ECHAPPEMENT Gene IV, V et VI.
	REF	RETÉN TRASERO CIGÜEÑAL	Crankshaft rear seal	PARAOLIO POSTERIORE ALBERO MOTORE	JOINT D'HUILE DE VILEBREQUIN ARRIÈRE
	REC26-14756	Gene IV Retén Contrarrotación dos piezas	Gene IV Reverse rotation oil seal Two- pieces	Gene IV Controrotante in 2 pz.	Gene IV Joint d'huile contre-rotatif en deux parties
	REF	TAPA VÁLVULAS	VALVE COVER	COPERCHIO VALVOLE	COUVERCLE SOUPAPES
	REC17935	Gen IV	Gen IV	Gen IV	Gen IV
	REC17937	Gen V & VI	Gen V & VI	Gen V e VI	Gen V et VI

8.2L 502 V8 HP465 (465 HP GEN. V) HP 600 SC (550HP GEN. V)  
 8.5L (-D857199) (400 HP GEN. IV)  
 8.2L (D857200 - F819619) (400 HP GEN.V) 500 (470 HP GEN V)  
 502 MAGNUM BRAVO (-D824588) (390HP GEN IV)  
 502 MAGNUM BRAVO (D824589+) (390 & 415 HP GEN. V)

REF	CULATA	CYLINDER HEAD	TESTATA	CULASSE
 FEL17049	Gen IV sólo H.O. super medida. Se necesitan 2.	Gen IV H.O. only super bore 2 required	Gen IV solo H.O. maggiorata. Necessarie 2	Gen IV seulement H.O. super taille. 2 sont nécessaires.
 REC17048	Gen IV, V & VI. Se necesitan 2.	Gen IV, V & VI. 2 required	Gen IV, V e VI. Necessita 2	Gen IV, V et VI. 2 sont nécessaires.
 REC17248	Gen IV & Gene V exc. EFI. Se incluye retenes de válvula y juntas tapa válvulas.	Gen IV & Gen V exc. EFI Premium valve stem seals & valve cover gaskets included.	Gen IV e Gene V escluso EFI. Include paraolio e guarnizione del coperchio valvola	Gen IV et Gen V exc. EFI. Les joints de cache culbuteur et de queue de soupape sont inclus.
 REC17207	Gen V & VI solo EFI. Se incluye retenes de válvula y juntas tapa válvulas.	Gen V & VI EFI only. Premium valve stem seals & valve cover gaskets included.	Gen V e VI solo EFI. Include paraolio e guarnizione del coperchio valvola	Gen V & VI EFI uniquement. Les joints de cache culbuteur et de queue de soupape sont inclus.
REF	INFERIOR	CONVERSION	PARTE BASSA	PARTIE BASSE
 REC17140	Gene IV con retén trasero de dos piezas y junta cárter de 4 piezas.	Gene IV w/two piece rear main bearing seal & four piece oil pan gasket.	Gene IV con paraolio posteriore in 2 pz. e guarnizione coppa dell'olio in 4 pz.	Gene IV avec joint arrière en deux parties et joint de carter en 4 parties.
 FEL17145	Gene V con retén trasero de una pieza y junta cárter de 1 pieza. Junta cárter incluida.	Gene V w/one piece rear main bearing seal & one piece oil pan gasket. oil pan gasket. incl.	Gene V con paraolio posteriore in 1 pz. e guarnizione coppa dell'olio in 1 pz.	Gene IV avec joint arrière en deux parties et joint de carter en 4 parties.
 REC17146	Gene VI con retén trasero de una pieza y junta cárter de 1 pieza. Junta cárter incluida.	Gene VI w/one piece rear main bearing seal & one piece oil pan gasket. oil pan gasket. incl.	Gene VI con paraolio posteriore in 1 pz. e guarnizione coppa dell'olio in gomma in 1 pz.	Gene VI avec joint arrière monobloc et joint de carter monobloc. Joint de carter inclus.
REF	COLECTOR ADMISIÓN-ESCAPE	MANIFOLD INTAKE & EXHAUST	COLLETORE ASPIRAZIONE-SCARICO	COLLECTEUR ADMISION ET ÉCHAPPEMENT
 REC17341	Gen IV, V y VI sólo H.O. con admisión rectangular. Gene IV, excl. H.O. con admisión rectangular.	Gen IV, V & VI, H.O. only with rectangular intake ports. Gen IV excl. H.O. with rect. intake ports.	Gen IV, V e VI solo H.O. con aspirazione rettangolare. Gen IV escluso H.O. con aspirazione rettangolare.	Gen IV, V et VI uniquement H.O.: avec admission rectangulaire. Gen IV, exc. H.O. avec admission rectangulaire.
 REC17340	JUNTA ADMISIÓN Gen V & VI sólo EFI.	INTAKE GASKET Gen V & VI only EFI.	GUARNIZIONE ASPIRAZIONE Gen V & VI solo EFI.	Joint d'admission Gen V et VI uniquement EFI.
REF	RETÉN TRASERO CIGÜEÑAL	CRANKSHAFT REAR SEAL	PARAOLIO POSTERIORE ALBERO MOTORE	JOINT D'HUILE DE VILEBREQUIN ARRIERE
 REC26-14756	Gen IV. Retén Contrarrotación dos pieza.	Gen IV. Reverse rotation oil seal Two- pieces	Gen IV. Controrotante in 2 pz.	Gen IV. Joint spi contre-rotatif en 2 parties.

	REF	TAPA VÁLVULAS	VALVE COVER	COPERCHIO VALVOLE	COUVERCLE SOUPPES
	REC17935	Gen IV	Gen IV	Gen IV	Gen IV
	REC17937	Gen V & VI	Gen V & VI	Gen V e VI	Gen V et VI

## JUNTAS DISTRIBUCIÓN TIMING GASKETS GUARNIZIONE DISTRIBUZIONE JOINTS DISTRIBUTION

### JUNTA TAPA DISTRIBUCION TIMING CHAIN COVERS GASKETS GAURNIZIONE CARTER JOINT COUVERCLE DISTRIBUTION

REF	OEM	
REC27-49953	27-49953	4 & 6 Cyl. GM120, 140, 160/165, 2.5L, 3.0LX/L (1963+)

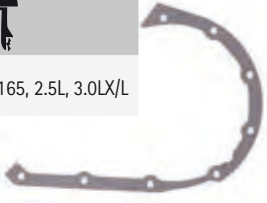

REF	OEM	
REC27-56108	27-56108	FORD V8 302, 351 (1970-77)



REF	OEM	
REC27-54529	27-54529	454 CID 427, 454, 482, 502 (-1992)



REF	OEM	
REC27-850456	27-85046	454, 502 / 7.4 & 8.2L GEN V & VI (1996+) Race Sterndrive 500, 520, 525, 540, 565, 575, 600, 662, 700



REF	OEM	
REC27-68714A6	27-68714	224 CID 165, 170, 180, 190, 470, 485 & 488

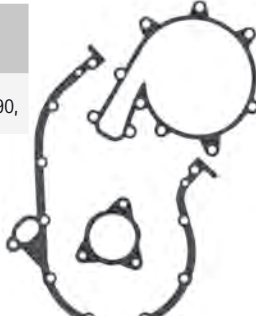

REF	OEM	
REC27-14250	27-14250	V6 & V8 (-1997)



## RETENES SEALS TENUTE JOINTS D'HUILE

### GUÍA TÓRICAS O-RING GUIDE GUIDA O-RING GUIDE JOINT SPI

REF	OEM	REF	OEM	REF	OEM	REF	OEM
REC25-20081	25-20081	REC25-30613	25-30613	REC25-38099	25-38099	REC25-62705	25-62705
REC25-16524	25-20415	REC553126	25-31305	REC25-38101	25-38101	REC25-62706	25-62707
REC25-16524	25-16524	REC3852866	25-31986	REC25-38933	25-38933	REC25-823683	25-823683
REC308627	25-20826	REC304174	25-32509	REC326849	25-39695	REC333572	25-64068
REC25-80863	25-20863	REC25-32546	25-32546	REC25-457101	25-457101	REC331188	25-65936
REC25-21836	25-21836	REC25-33145	25-33145	REC326649	25-45711	REC313175	25-67202
REC25-25439	25-25439	REC25-33465	25-33465	REC310414	25-47254	REC25-67202	25-67202
REC333572	25-26543	REC302537	25-33466	REC25-48171	25-48171	REC25-70937	25-70937
REC302588	25-26722	REC0307239	25-33504	REC302035	25-48452	REC3852865	25-805331
REC303347	25-26802	REC305123	25-33756	REC25-33465	25-54029	REC25-89497	25-89497
REC3852928	25-26855	REC25-35029	25-35029	REC25-55801	25-55801	REC25-90011	25-90011
REC309731	25-29439	REC310584	25-35276	REC909140	25-58390	REC25-97387	25-97387
REC25-30224	25-30224Q	REC321921	25-35480	REC25-62700	25-62700		
REC25-30529	25-30529	REC301967	25-36318	REC3852045	25-62704		

GUÍA RETENES ACEITE

OIL SEALS GUIDE

GUIDA PARAOLIO

GUIDE JOINTS D'HUILE

REF	OEM	Ø EJE SHAFT Ø Ø ASSE Ø ARBRE (*)	Ø EXTERIOR OUTER Ø Ø ESTERNO Ø EXTERIEUR (*)	REF	OEM	Ø EJE SHAFT Ø Ø ASSE Ø ARBRE (*)	Ø EXTERIOR OUTER Ø Ø ESTERNO Ø EXTERIEUR (*)	REF	OEM	Ø EJE SHAFT Ø Ø ASSE Ø ARBRE (*)	Ø EXTERIOR OUTER Ø Ø ESTERNO Ø EXTERIEUR (*)
REC26-12224	26-12224	1.1875	1.6875	REC26-455771	26-45577 1	0.3125	0.4375	REC26-8164641	26-8164641	0.3750	0.7500
REC26-12709	26-12709	0.5000	0.6875	REC26-45587	26-45587	0.3750	0.6250	REC26-821092	26-821092	1.5000	2.2500
REC26-76868	26-14077	1.1875	1.6875	REC26-55682	25-55682	1.0000	1.2500	REC26-823894	26-823894	2.2500	3.0000
REC26-14240	26-14240	3.8125	4.5000	REC26-56397	26-56397	0.7500	1.1250	REC26-24590	26-892361	0.3750	0.7500
REC26-16977	26-16977	0.8750	1.2500	REC26-56788	26-56788	0.8750	1.2500	REC26-89238	26-89238	0.8750	1.5000
REC908855	26-20070	0.6250	1.0000	REC26-62818	26-62818	1.6250	2.2500	REC26-90562	26-90562	0.7500	1.2500
REC310599	26-26226	1.0000	1.5000	REC26-66302	26-66302	1.2500	1.8750	REC26-94038	26-94038	1.0000	1.5000
REC26-30913	26-30913	0.5000	1.1875	REC26-69188	26-69188	0.8750	1.2500	REC26-897153	26-96063	0.4375	0.8750
REC26-24590	26-31249	0.3750	0.5625	REC26-69189	26-69189	0.8750	1.3125	REC26-965031	26-965031	0.8750	1.3750
REC26-32511	26-32511	1.2500	2.0000	REC26-70081	26-70081	1.1875	1.7500	REC26-43993	26-43993	1640	2132
REC26-32911	26-32911	1.1250	1.2500	REC26-72785	26-72785	0.7500	1.8750	REC26-67388	26-67388	1800	3100
REC26-33467	26-33467	0.6250	1.1250	REC26-76868	26-76868	1.1875	1.6875	REC26-33467	26-33467	625	1125
REC26-419533	26-41953	1.1875	1.8750	REC26-79831	26-79831	0.7500	1.1250	REC26-16977	26-16977	875	1250
REC26-43035	26-43035	1.0625	1.4375	REC26-861694	26-805080	2.5000	3.1875	REC26-24590	26-24590	400	566
REC26-43036	26-43036	1.0312	1.4687	REC26-807006	26-807006	1.6875	2.2500	REC26-55682	26-55682	1000	1253

VÁLVULA ADMISIÓN

INTAKE VALVE

VALVOLA ASPIRAZIONE

SOUPAPE ADMISSION

REF	OEM	Ø EJE SHAFT Ø Ø ASSE Ø ARBRE (*)	Ø EXTERIOR OUTER Ø Ø ESTERNO Ø EXTERIEUR (*)
REC70817B	26-97664 26-976641 26-8M0050563	4.3L, 5.0L, Et 5.7L old Et MPI (1983-97)	



RETENES VÁLVULAS

VALVE STEM SEAL

PARAOLIO VALVOLE

JOINT DE QUEUE DE SOUPAPE

REF	OEM	Ø EJE SHAFT Ø Ø ASSE Ø ARBRE (*)	Ø EXTERIOR OUTER Ø Ø ESTERNO Ø EXTERIEUR (*)
REC26-34217	26-34217	4 en línea y 6 cil, GM antiguos   early   vecchio   ancienes V6/V8	



REF	OEM	Ø EJE SHAFT Ø Ø ASSE Ø ARBRE (*)	Ø EXTERIOR OUTER Ø Ø ESTERNO Ø EXTERIEUR (*)
REC26-75988	26-75988	330 (4623115+) 340 (5889914+) 454 Mag (A631894+)	



RETÉN VÁLVULA ESCAPE

VALVE STEM SEAL

GUARNIZIONE DELLO STELO DELLA VALVOLA

JOINT DE TIGE DE SOUPAPE

new

REF	OEM	Ø EJE SHAFT Ø Ø ASSE Ø ARBRE (*)	Ø EXTERIOR OUTER Ø Ø ESTERNO Ø EXTERIEUR (*)
REC26-8M0150312	26-8M0150312 26-804507	V6 Et V8 small Vortec Et MPI	



RETÉN ADMISIÓN Y ESCAPE

INTAKE & EXHAUST VALVE

PARAOLIO ASPIRAZIONE E ESCARICO

JOINT D'HUILE ADMISSION ET ECHAPPEMENT

REF	OEM	Ø EJE SHAFT Ø Ø ASSE Ø ARBRE (*)	Ø EXTERIOR OUTER Ø Ø ESTERNO Ø EXTERIEUR (*)
REC26-75624	26-75624 26-75413	165, 170, 180, 190 4 CIL. (224 cid) (6916779+) 888 (2bbl) Ford 302 V8 (1971-77) 3.7 L, LX (1980-89) 470 (1976-81) 488 (1983-84)	



RETENES CIGÜENAL

CRANKSHAFT SEAL

PARAOLIO ALBERO MOTORE

JOINTS D'HUILE VILEBREQUIN

REF	OEM	Ø EJE SHAFT Ø Ø ASSE Ø ARBRE (*)	Ø EXTERIOR OUTER Ø Ø ESTERNO Ø EXTERIEUR (*)
FELBS40013	26-814622	5.0, 5.7L (-1986)	



REF	OEM	Ø EJE SHAFT Ø Ø ASSE Ø ARBRE (*)	Ø EXTERIOR OUTER Ø Ø ESTERNO Ø EXTERIEUR (*)
REC3853341	36-97335		
REC26-8219471	26-8219471		
REC26-67388	26-67388		
REC26-8219471	26-8219471		



REF	OEM	Ø EJE SHAFT Ø Ø ASSE Ø ARBRE (*)	Ø EXTERIOR OUTER Ø Ø ESTERNO Ø EXTERIEUR (*)
REC26-14240	26-14240	4.3, 5.0, 5.7L Standard Rot.	



REF	OEM	Ø EJE SHAFT Ø Ø ASSE Ø ARBRE (*)	Ø EXTERIOR OUTER Ø Ø ESTERNO Ø EXTERIEUR (*)
REC26-14240	26-14240		
REC26-811554	26-811554		
REC26-90925	26-90925		
RM26-879194364			
FEL17725			



REF	OEM	Ø EJE SHAFT Ø Ø ASSE Ø ARBRE (*)	Ø EXTERIOR OUTER Ø Ø ESTERNO Ø EXTERIEUR (*)
REC26-14756	26-14756	7.4, 8.2L (1991+)	



REF	OEM	Ø EJE SHAFT Ø Ø ASSE Ø ARBRE (*)	Ø EXTERIOR OUTER Ø Ø ESTERNO Ø EXTERIEUR (*)
FEL17740	26-75980		





GUÍA RETENES CIGÜEÑAL		CRANKSHAFT SEAL GUIDE		GUIDA PARAOLIO ALBERO MOTORE		GUIDE JOINTS D'HUILE DU VILEBREQUIN	
MOD.	SERIE SERIAL SERIE	TRASERO REAR POSTERIORE DERRIERE	DELANTERO FRONT ANTERIORE DAVANT	MOD.	SERIE SERIAL SERIE	TRASERO REAR POSTERIORE DERRIERE	DELANTERO FRONT ANTERIORE DAVANT
120/2.5L	1666601		REC3853341	5.0L, 5.7L, 4.3L, 3.0L (Rot. STD 1 p.)		REC26-14240	REC3853341
120/2.5L	2786857	FELBS40013	REC3853341	340 (7.4L)	4623115	FEL17740	REC26-8219471
140/3.0L & LX	2508261		REC3853341	370 TRS	5889914		REC26-8219471
140/3.0L & LX	6229718	FELBS40013	REC3853341	400 TRS	4179554		REC26-8219471
150, 160, 165, 200 (I/L-6)	1666495		REC3853341	420	A398941+		REC26-8219471
150, 160, 165, 200 (I/L-6)	2770032	FELBS40013	REC3853341	440 TRS	4179554		REC26-8219471
175, 185, 205, 262 4.3L (V-6)	6330183	FELBS40013	REC3853341	454 MAGNUM	A631894+		REC26-8219471
200, 228, 225, 230, 250,				460 TRS	4179554		REC26-8219471
255, 260, 270, 280, 300, 320	2453769	FELBS40013	REC3853341	7.4, 8.2L, 454, 502 (Rot. STD 1 p.)		REC26-811554	REC26-8219471
5.0L/5.7L/898 (V-8)				7.4 BRAVO	B771113+		REC26-8219471
224I/L4		REC26-90925	REC26-67388				

## JUNTAS MOTOR ENGINE GASKETS GUARNIZIONE MOTORE JOINTS DE MOTEUR

470, 485, 488, 165, 170, 180 & 190 HP  
4 CYL EN LINEA | IN LINE | IN LINEA | EN LIGNE

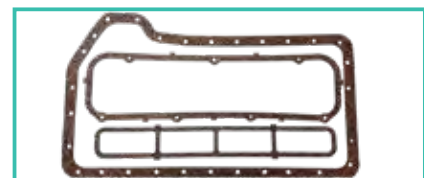
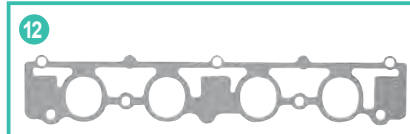
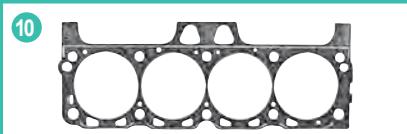
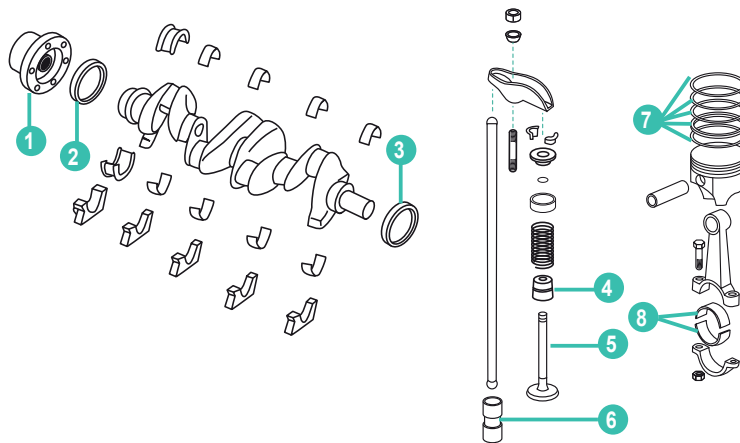

REF	OEM
REC27-72479A5	27-72479A5

	REF	OEM	MOD.				UN.	
1	REC97432A2	97432A2	470 (1983-89), 165, 170, 3.7L	ACOPLAMIENTO MOTOR	ENGINE COUPLER ASSEMBLY	GIUNTO PARASTRAPPI	COUPLING	1
	REC69354A2	69354A2	470 & 485 (1976-82)					
2	REC26-90925	26-90925		RETÉN TRASERO	REAR MAIN SEAL	PARAOLIO POSTERIORE	JOINT SPI VILEBREQUIN	1
3	REC26-67388	26-67388		RETÉN DELANTERO	FRONT CRANKSHAFT SEAL	TENUTA ALBERO MOTORE	JOINT D'HUILE	1
4	REC26-75624	26-75624		RETÉN VÁLVULA	VALVE STEM SEAL	PARAOLIO VALVOLA	JOINT QUEUE DE SOUPEPE	8
	FEDV-3929	75416	470	VÁLVULA ADMISIÓN	INTAKE VALVE	VALVOLA ASPIRAZIONE	SOUPEPE ADMISSION	4
5	RM44181A1	44181A1	485					
	FEDV-1984	44182A1	470	VÁLVULA ESCAPE	EXHAUST VALVE	VALVOLA SCARICO	SOUPEPE ÉCHAPPEMENT	4
	RM44182A1	44182A1	485					
6	REC3853847	56153		LIFTER	TAPPET	LIFTER	POUSSOIR HYDRAULIQUE	8
7	REC39-74381A1	39-74381A1		AROS PISTON STD.	PISTON RINGS STD.	FASCE PISTONE STD.	KIT SEGMENTS STD	4
8	REC23-853853002	23-853853002		COJINETES BIELA STD.	ROD BEARING STD.	BRONZINE DI BIELLA STD.	COUSSINET DE BIELLE STD	4
	REC23-853855001	23-853855001		COJINETES BIELA 010	ROD BEARING 010	BRONZINE DI BIELLA 0.10	COUSSINET DE BIELLE 0.10	4
9	REC27-73666	27-73666	224 CID (3.7 L)	JUNTA TAPA VÁLVULAS	VALVE COVER GASKET	GUARNIZIONE COPERCHIO PUNTERIE	JOINTS COUVERCLE SOUPEPE	
10	REC27-13709	27-13709	224 CID (3.7 L) CID Model 470	JUNTA CULATA	HEAD GASKET	GUARNIZIONE TESTATA	JOINT CULASSE	
11	REC27-68715	27-68715	460 CID	JUNTA COLECTOR ESCAPE	EXHAUST MANIFOLD GASKET	GUAR. COLLETTORE SCARICO	JOINT COLLECTEUR ÉCHAP.	
12	REC27-70905	27-70905	3.7 L	JUNTS COLECTOR ADMISION	INTALKE MANIFOLD GASKET	GUAR. COLLETTORE ASPIRAZIONE	JOINT COLLECTEUR ADMI.	

# SISTEMA DE ESCAPE Y ADMISIÓN EXHAUST & INTAKE SYSTEM

# SISTEMA DI SCARICO E ASPIRAZIONE SYSTEME D'ÉCHAPPEMENT ET D'ADMISSION

120HP GM 153  
4CYL

COLECTOR ESCAPE

EXHAUST MANIFOLD

COLLETTORE SCARICO

COLLECTEUR  
D'ÉCHAPPEMENT

REF	OEM
BAMC-1-63122	63122A14 63122A10 63122A13



JUNTA COLECTOR

MANIFOLD GASKET

GUARNIZIONE  
COLLETTORE

JOINT COLLECTEUR

REF	OEM
REC27-52546	27-52546
REC27-35898T	27-35898T



REC27-52546

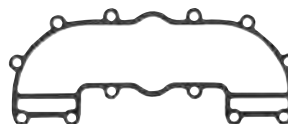

REC27-35898T

TAPA COLECTOR

END CAP

COPERCHIO COLLETTORE

COVERCLE COLLECTEUR

REF	OEM
BA1-47638	47638A1
HGE4870	73813A1



BA1-47638



HGE4870

JUNTA TAPA COLECTOR

END CAP GASKET

GUARNIZIONE  
COPERCHIO COLLETTORE

JOINT COVERCLE  
COLLECTEUR

REF	OEM
REC27-39917	27-39917
BAMC47-27-39923	27-39923

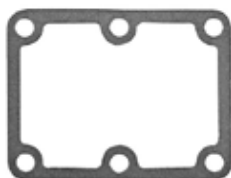

REC27-39917

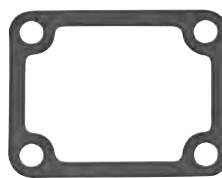

BAMC47-27-39923

CODO ESCAPE

ELBOW MANIFOLD

GOMITO DI SCARICO

COUDE D'ÉCHAPPEMENT

REF	OEM
BAMC-20-55538	55538A2



JUNTA CODO ESCAPE

ELBOW MANIFOLD  
GASKET

GUARNIZIONE GOMITO DI  
SCARICO

JOINT COUDE  
D'ÉCHAPPEMENT

REF	OEM
REC27-39915	27-39915

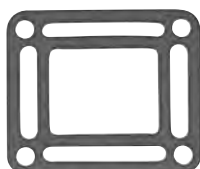

DESPIECES COLECTORES Y CODOS    MANIFOLDS & ELBOWS PARTS    PARTI COLLETTORI E GOMITI    PIÈCES COLLECTEURS ET COUDES

140HP GM181  
4 CYL (1968-82)

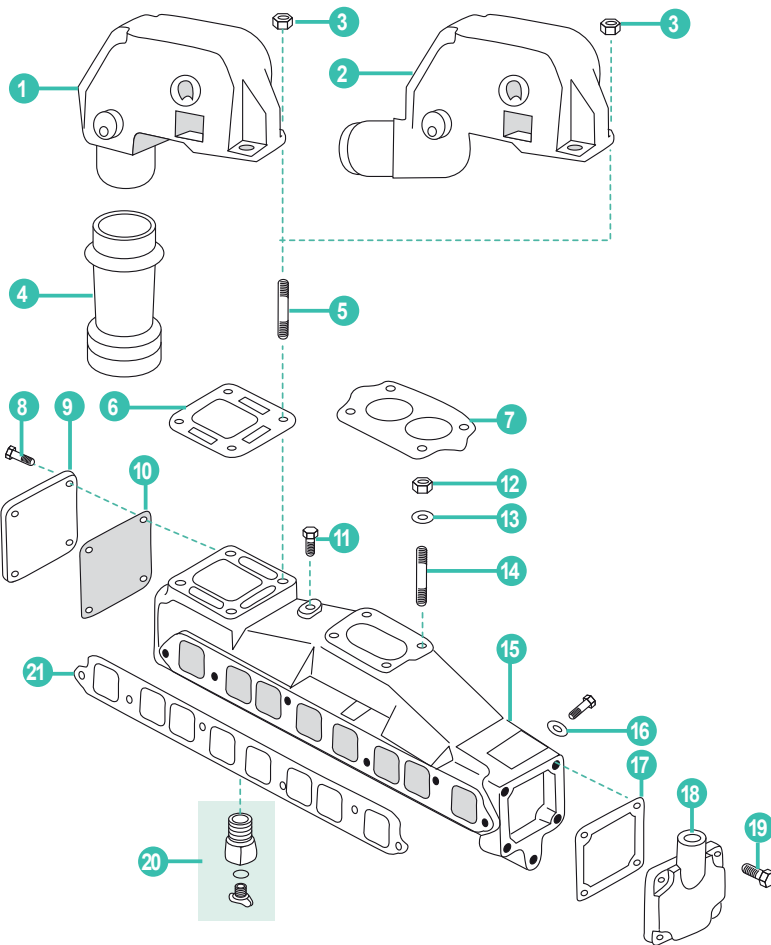

REF    OEM  
REC18-8549



REF    OEM  
HOT26371-MK

	REF	OEM					UN.
1	HOT20971	76351A04	CODO ESCAPE 3"	EXHAUST ELBOW ASSY 3"	GOMITO DI SCARICO	COUDE D'ÉCHAPPEMENT 3"	1
2	HOT20978 REC76771A2	76771A2	CODO ESCAPE 3"	EXHAUST ELBOW ASSY 3"	GOMITO DI SCARICO 3"	COUDE D'ÉCHAPPEMENT 3"	1
3	REC46335	46335	TUERCA	FLANGE SERRATED NUT	DADO	ÉCROU	4
4	REC53114A1 CEF500524	53114A1	FUELLE ESCAPE	EXHAUST ELBOW BELOW	MANICOTTO SCARICO COLLETTORE	SOUFFLET D'ÉCHAPPEMENT	6
5	REC16-49545	16-49545	ESPARRAGO CODO	STUD	PRIGIONIERO	GOUJON DE COLLECTEUR	4
6	REC27-99777Q02	27-99777Q02	JUNTA CODO	GASKET EXHAUST MANIFOLD TO ELBOW	GUARNIZIONE INTERMEDIA	JOINT COUDE	1
7	REC27-64692	27-64692	JUNTA BASE CARB.	GASKET CARBURETOR BASE	GUARNIZIONE BASE CARB.	JOINT BASSE DU CARBURATEUR	1
8	RM10-25299	10-824941	TORNILLO TAPA	SCREW END CAP	VITE COPERCHIO	VIS COUVERCLE	4
9	HGE4870	73813A1	TAPA COLECTOR	END CAP EXHAUST MANIFOLD	COPERCHIO	COUVERCLE	1
10	REC27-807218	27-807218	JUNTA TAPA	GASKET END CAP	GUARNIZIONE COPERCHIO	JOINT COUVERCLE	1
11	REC22-36382	22-36382	TAPON	PLUG	TAPPO	BOUCHON	1
12	REC11-862902	11-862902	TUERCA	LOCKNUT CARBURETOR	DADO	ÉCROU	4
13	REC12-20084	12-20084	ARANDELA	WASHER CARBURETOR	RONDELLA	RONDELLE	4
14	REC16-70236	16-70236	ESPARRAGO CARBURADOR	STUD CARBURETOR	PRIGIONIERO CARBURATORE	GOUJON CARBURATEUR	4
15	REC96705A1	96705A1	COLECTOR ESCAPE	EXHAUST MANIFOLD ASSEMBLY	COLLETTORE	COLLECTEUR	1
16	REC13-35048	21-20553	ARANDELLA	WASHER	RONDELLA	RONDELLE	6
17	REC27-480431	27-480431	JUNTA TAPA	GASKET END CAP	GUARNIZIONE COPERCHIO	JOINT COUVERCLE	1
18	REC60252A2	60252A2	TAPA COLECTOR	END CAP EXHAUST MANIFOLD	COPERCHIO COLLETTORE	COUVERCLE COLLECTEUR	1
19	REC10-35386	10-35386	TORNILLO TAPA	SCREW END CAP	VITE COPERCHIO	VIS COUVERCLE	4
20	REC13980	22-806608A1	TORNILLO DRENAJE	STRAIGHT FITTING	VITE DI DRENAGGIO	VIS DE VIDANGE	1
21	REC27-53354	27-53354	JUNTA COLECTOR	GASKET-EXHAUST MANIFOLD	GUARNIZIONE COLLETTORE	JOINT COLLECTEUR	1

2.5L GM 153 4 CYL  
3.0L 4 CYL (1983-89)

MODELO ANTIGUO  
OLD STYLE OPTION  
MODELLO VECCHIO  
MODEL ANCIEN

MODELO MODERNO  
NEW STYLE OPTION  
MODELLO MODERNO  
MODEL MODERN

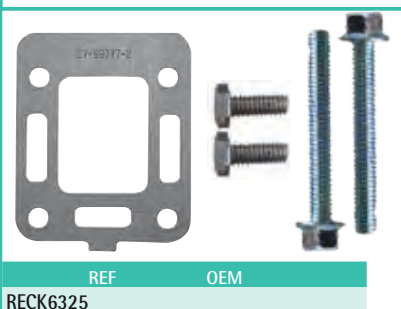
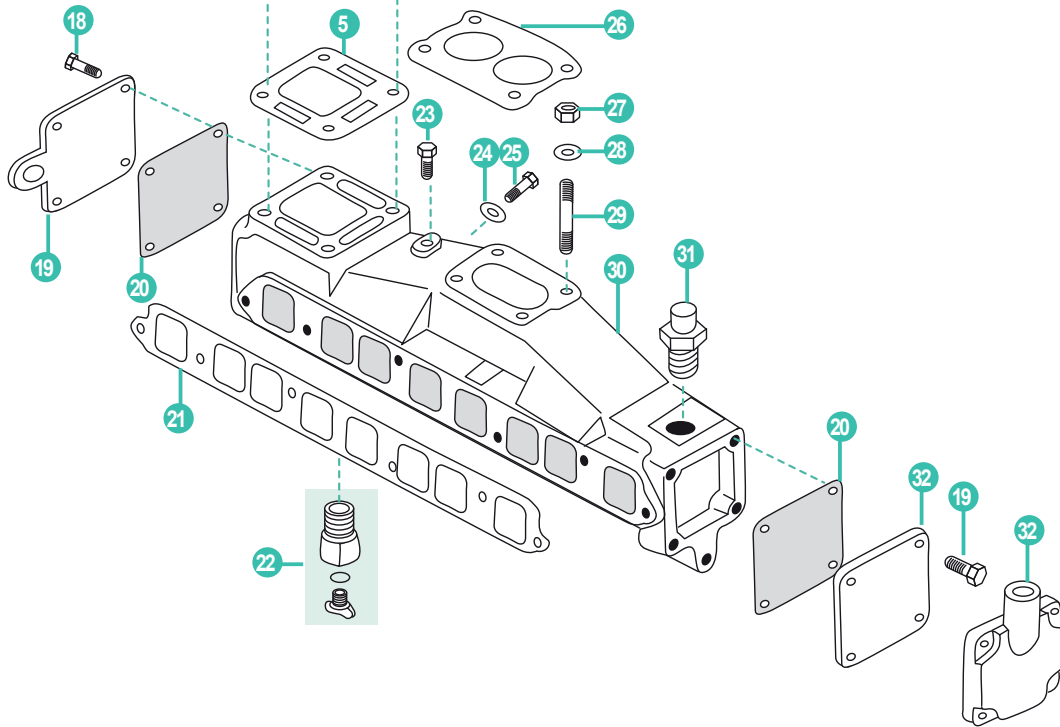
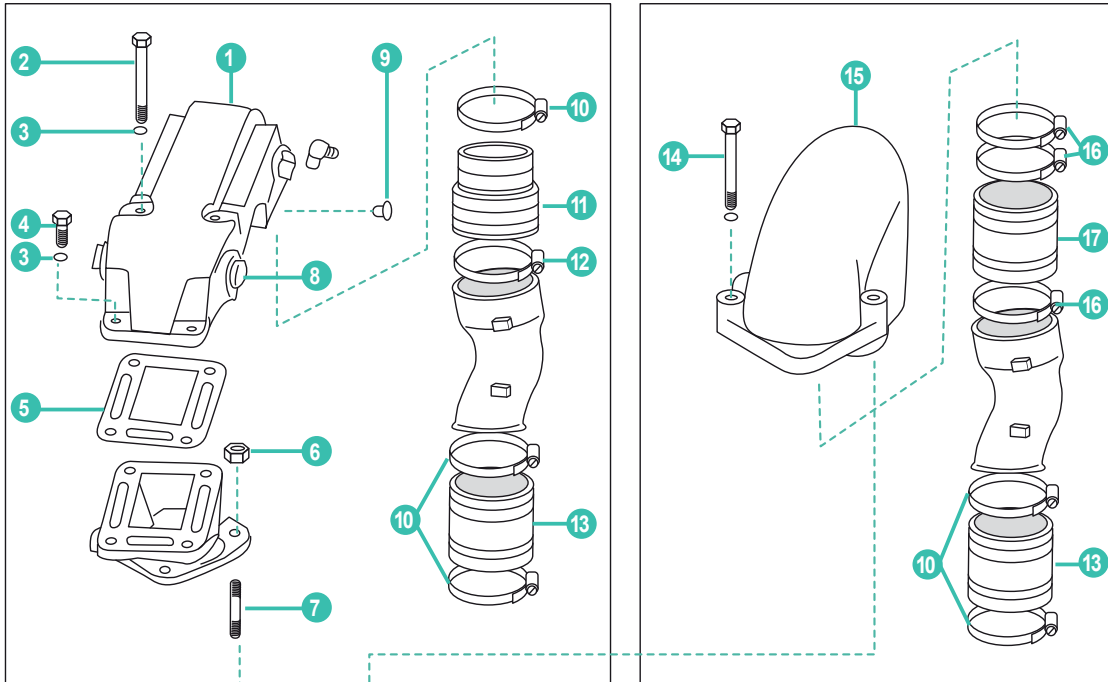



	REF	OEM					UN.
1	REC76325A2	76325A2	CODO ESCAPE	EXHAUST ELBOW ASSEMBLY	GOMITO SCARICO	COUDE D'ÉCHAPPEMENT	1
2	REC10-72094	10-72094	TORNILLO CODO ESCAPE	SCREW EXHAUST ELBOW	VITE GOMITO SCARICO	VIS COUDE D'ÉCHAPPEMENT	2
3	REC13-35048	13-35048	ARANDELA	LOCKWASHER	RONDELLA	RONDELLE	4
4	REC10-34354	10-34354	TORNILLO CODO ESCAPE	SCREW EXHAUST ELBOW	VITE GOMITO SCARICO	VIS	2
5	REC27-99777Q02	27-99777Q02	JUNTA COLECTOR ESCAPE A CODO	GASKET EXHAUST MANIFOLD TO ELBOW OR ADAPTOR	GUARNIZIONE COLLETTORE SCARICO E RISER	JOINT COUDE D'ÉCHAPPEMENT	2
6	REC46335	46335	TUERCA	FLANGE SERRATED NUT	DADO	ÉCROU	4
7	REC16-56826	16-56826	ESPARRAGO	STUD	PRIGIONIERO	GOUJON	4
8	REC22-41622	22-41622	TAPON	PLUG EXHAUST ELBOW	TAPPO	BOUCHON	4
9	REC22-328022	22-328022	TAPÓN	PLUG	TAPPO	BOUCHON	1
10	GS38320	54-815504256	ABRAZADERA	HOSE CLAMP	FASCETTA	COLLIER INOX	3
11	REC70981A3	70981A3	FUELLE ESCAPE	EXHAUST BELLOW (USE WITH 2-PIECE EXHAUST ELBOW)	MANICOTTO SCARICO	DURITE D'ÉCHAPPEMENT	1
12	GS38322	54-815504372	ABRAZADERA	HOSE CLAMP	FASCETTA	COLLIER	1
13	REC32-90949T	32-90949T	FUELLE	EXHAUST TUBE	CUFFIA	SOUFFLET	1
14	REC10-668631	10-668631	TORNILLO	SCREW	VITE	VIS	2
15	SED3092610	12076A2	CODO ESCAPE INOX	STAINLESS STEEL EXHAUST ELBOW	GOMITO SCARICO INOX	COUDE D'ÉCHAPPEMENT INOX	1
	MAR076		CODO ESCAPE	EXHAUST ELBOW ASSEMBLY	GOMITO SCARICO	COUDE D'ÉCHAPPEMENT	1
16	GS38320	54-815504372	ABRAZADERA 4"	CLAMP BELLOW 4"	FASCETTA 4"	COLLIER 4"	2
17	REC32-44348001	32-44348001	FUELLE ESCAPE 4"	EXHAUST BELLOW EXHAUST ELBOW 4"	CUFFIA SCARICO 4"	SOUFFLET D'ÉCHAPPEMENT 4"	1
18	RM10-25299	10-824941	TORNILLO COLECTOR ESCAPE	SCREW END CAP TO EXHAUST MANIFOLD	VITE COLLETTORE SCARICO	VIS COLLECTEUR D'ÉCHAPPEMENT	8
19	REC805629A1	805629A1	TAPA COLECTOR ESCAPE	END CAP EXHAUST MANIFOLD	COPERCHIO COLLETTORE SCARICO	COUVERCLE COLLECTEUR D'ÉCHAPPEMENT	1
20	REC27-807218	27-807218	JUNTA	GASKET END CAP	GUARNIZIONE COPERCHIO COLLETTORE	JOINT COUVERCLE COLLECTEUR	2
21	REC27-96429	27-96429	JUNTA CODO ESCAPE	GASKET EXHAUST MANIFOLD	GUARNIZIONE GOMITO SCARICO	JOINT COUDE D'ÉCHAPPEMENT	1
22	REC13980	22-806608A1	RACORD COLECTOR	STRAIGHT DRAIN KIT	RACCORDO COLLETTORE	RACCORD COLLECTEUR	1
23	REC22-36382	22-36382	TAPÓN	PLUG	TAPPO	BOUCHON	1
24	REC13-35048	21-20553	ARANDELA	WASHER	FASCETTA	RONDELLE	2
25	REC10-53728	10-53728	TORNILLO	SCREW (NEW DESIGN)	VITE	VIS	3
26	REC27-8079821	27-8079821	JUNTA BASE CARBURADOR (MERCAB)	GASKET CARBURETOR BASE (MERCAB)	GUARNIZIONE BASE CARBURATORE (MERCAB)	JOINT DE BASE CARBURATEUR (MERCAB)	1
	REC27-64692	27-64692	JUNTA BASE CARBURADOR (ROCHESTER)	GASKET CARBURETOR BASE (ROCHESTER)	GUARNIZIONE BASE CARBURATORE (ROCHESTER)	JOINT DE BASE CARBURATEUR (ROCHESTER)	1
27	REC11-862902	11-862902	TUERCA	LOCK NUT CARBURETOR	CHIUSURA	ÉCROU	4
28	REC12-20084	12-20084	ARANDELA	WASHER CARBURETOR	RONDELLA	RONDELLE	4
29	REC16-70236	16-70236	ESPARRAGO	STUD CARBURETOR	PRIGIONIERO	GOUJON	4
30	BAMC-1-95862	95862A5	COLECTOR ESCAPE (ROCHESTER)	EXHAUST MANIFOLD (ROCHESTER)	COLLETTORE SCARICO (ROCHESTER)	COLLECTEUR D'ÉCHAPPEMENT (ROCHESTER)	1
	HOT20956	860235A04	COLECTOR ESCAPE (MERCAB)	EXHAUST MANIFOLD (MERCAB)	COLLETTORE SCARICO (MERCAB)	COLLECTEUR D'ÉCHAPPEMENT (MERCAB)	1
31	REC22-866725	22-866725	ENTRONQUE 3/4-14x1 (LATÓN)	STRAIGHT FITTING 3/4-14 x 1 (BRASS)	RACCORDO 3/4-14x1 (OTTONE)	RACCORD COLLECTEUR (LAITON)	1
32	HGE4870	73813A1	TAPA COLECTOR ESCAPE	END CAP - EXHAUST MANIFOLD	COPERCHIO COLLETTORE SCARICO	COUVERCLE COLLECTEUR D'ÉCHAPPEMENT	1
	REC60252A2	60252A2	TAPA COLECTOR PIPA	MANIFOLD CAP PIPE	COPERCHIO COLLETTORE SCARICO	PLAQUE A/TUYAU	1

Para determinar el tipo de carburador (Rochester / Mercab) ver medida de junta:  
 To determine the type of carburetor (Rochester / Mercab) see joint measurement:  
 Per determinare il tipo di carburatore (Rochester / Mercab) vedi misurazione di guarnizione:  
 Pour déterminer le carburateur (Rochester / Mercab) voir la mesure de joint:



3.0L & 3.0LX GM 181  
4 CYL (1990+)



REF  
HOT20975-MK

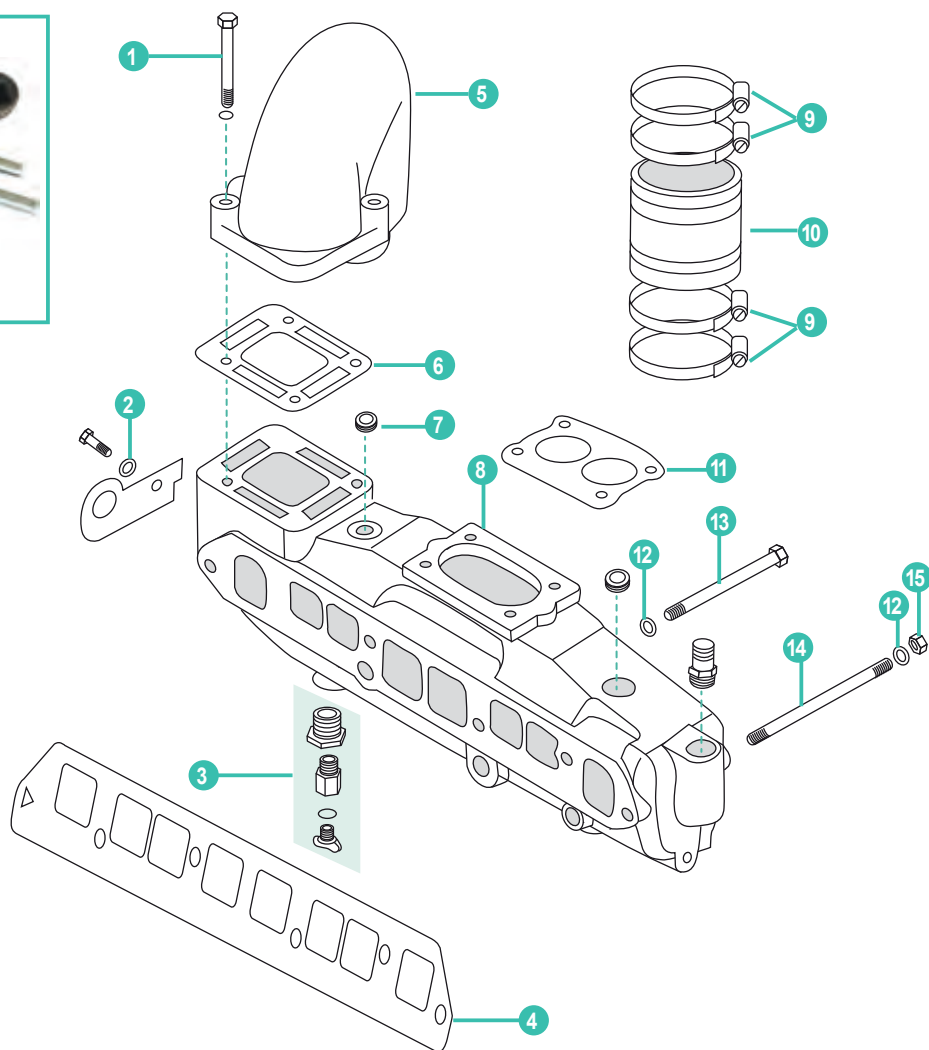

	REF	OEM					UN.
1	REC10-668631	10-668631	TORNILLO	SCREW	VITE	VIS	2
2	REC12-20084	12-20084	ARANDELA	WASHER	RONDELLA	RONDELLE	1
3	REC13980	22-806608A1	RACORD COLECTOR	STRAIGHT DRAIN KIT	RACCORDO COLLETTORE	RACCORD COLLECTEUR	1
4	REC27-815528	27-815528	JUNTA COLECTOR	GASKET EXHAUST MANIFOLD	GUARNIZIONE COLLETTORE	JOINT COLLECTEUR	1
	MAR076	12076A2	CODO ESCAPE	EXHAUST ELBOW	GOMITO DI SCARICO	COUDE D'ÉCHAPPEMENT	1
5	SED3092610	12076A2	CODO ESCAPE INOX	EXHAUST ELBOW STAINLESS STEEL	GOMITO DI SCARICO INOX	COUDE D'ÉCHAPPEMENT INOX.	1
6	REC27-99777Q02	27-99777Q02	JUNTA CODO ESCAPE A COLECTOR	GASKET EXHAUST MANIFOLD TO ELBOW	GUARNIZIONE COLLETTORE A GOMITO	JOINT COLLECTEUR À COUDE D'ÉCHAPPEMENT	1
7	REC22-32803	22-32803	TAPÓN	CAP	TAPPO	BOUCHON	1
8	REC860235A03	860235A03	COLECTOR ESCAPE	EXHAUST MANIFOLD	COLLETTORE DI SCARICO	COLLECTEUR D'ÉCHAPPEMENT	1
9	GS38320	54-815504256	ABRAZADERA FUELLE 4"	CLAMP 4"	FASCETTA 4"	COLLIER 4"	2
10	REC32-44348001	32-44348001	FUELLE CODO ESCAPE 4"	EXHAUST BELLOW 4"	CUFFIA GOMITO DI SCARICO 4"	SOUFFLET COUDE D'ÉCHAPPEMENT 4"	1
11	REC27-8079821	27-8079821	JUNTA CARBURADOR MERCAB (NO TKS)	CARBURATOR GASKET MERCAB (NO TKS)	GUARNIZIONE CARBURATORE MERCAB (NO TKS)	JOINT CARBURATEUR MERCAB (NO TKS)	1
12	REC13-35048	21-20553	ARANDELA	WASHER	RONDELLA	RONDELLE	5
13	REC10-53728	10-53728	TORNILLO	SCREW	VITE	VIS	2
14	REC16-806300	16-806300	ESPARRAGO	STUD	PRIGIONIERO	GOIJON	3
15	REC46335	46335	TUERCA	FLANGE SERRATED NUT	DADO	ÉCROU	3
16	HOT20975-MK		KIT MONTAJE	MOUNTING KIT	KIT DI MONTAGGIO	KIT DE MONTAGE	

### 3.0L MPI

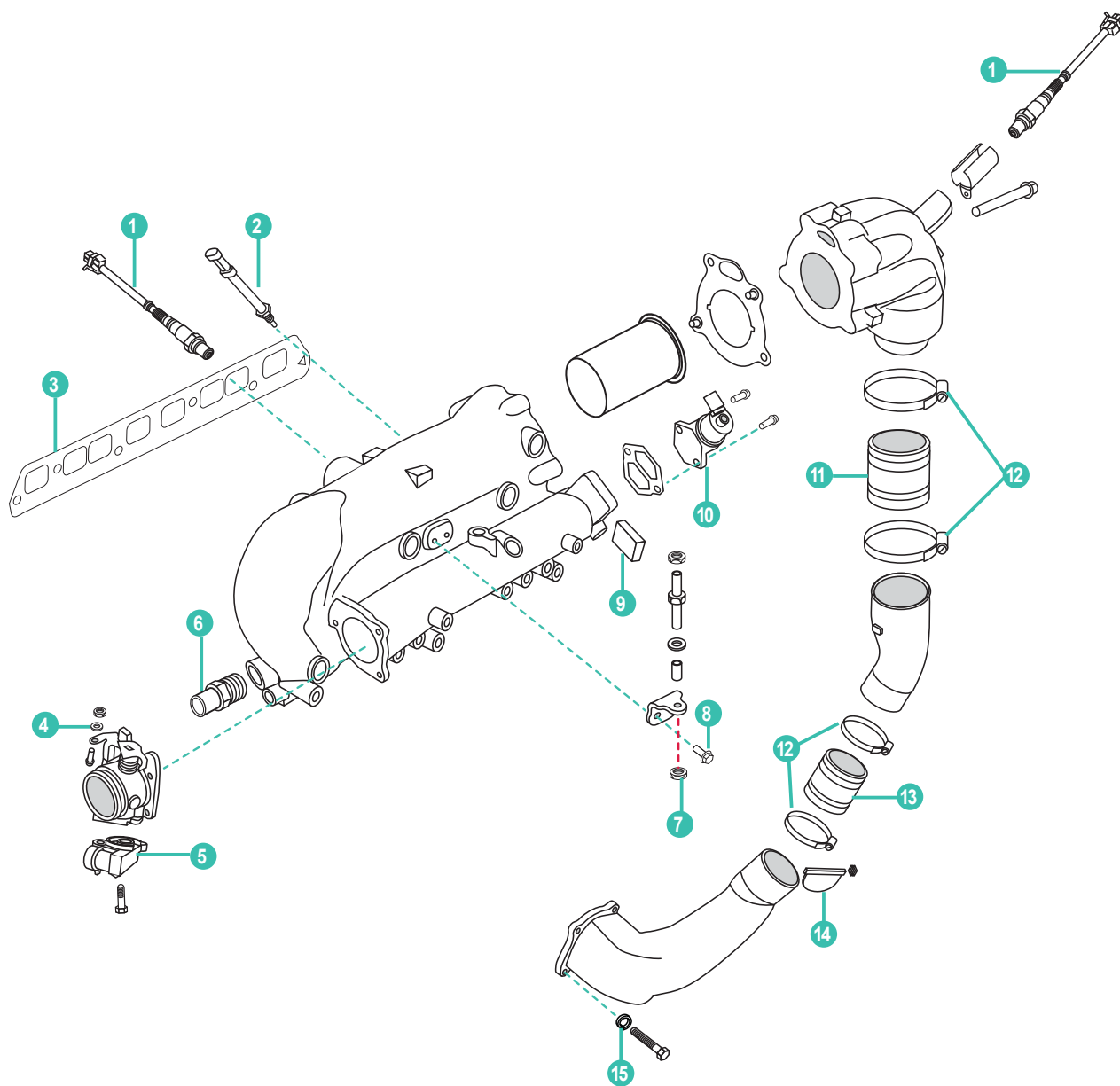

	REF	OEM				UN.	
1	REC8M2003959	8M2003959	SENSOR DE OXÍGENO	OXIGEN SENSOR	SENSORE OSSIGENO	SENSEUR OXIGENE	2
2	REC8M0148668	8M0148668	SENSOR TEMPERATURA	TEMPERATURE SENSOR	SENSORE TEMPERATURA	SONDE TEMPERATURE	1
3	REC27-815528	27-815528	JUNTA COLECTOR ESCAPE	MANIFOLD GASKET	GUARNIZIONE COLLETTORE SCARICO	JOINT DE COLLECTEUR D'ÉCHAPPEMENT	1
4	REC13-35048	13-35048	ARANDELA	WASHER	RONDELLA	RONDELLE	1
5	REC8M0125617	8M0125617	SENSOR DE POSICIÓN	POSITION SENSOR	SENSORE POSIZIONE	SENSEUR POSITION	1
6	REC22-866725	22-866725	RACORD COLECTOR	STRAIGHT FITTING	RACCORDO COLLETTORE	RACCORD COLLECTEUR	1
7	REC11-8267089	11-8267089	TUERCA	NUT	DADO	ÉCROU	1
8	REC10-816928	10-816928	TORNILLO M6X16	SCREW M6X16	VITE M6X16	VIS M6X16	2
9	REC35-865266	35-865266	FILTRO	FILTER	FILTRO	FILTRE	1
10	REC862998	862998	VÁLVULA AIRE IDLE	VALVE IDLE AIRE	VALVOLA IDLE ARIA	SOUPEAU IDLE AIR	1
11	REC32-44348001	32-44348001	TUBO ESCAPE	TUBE EXHASUT	TUBO SCARICO	TUYAU ÉCHAPPEMENT	1
12	GS38320	54-815504272	ABRAZADERA	CLAMP	FASCETTA	COLLIER	8
13	REC32-90949T	32-90949T	TUBO ESCAPE	TUBE EXHAUST	TUBO SCARICO	TUYAU ÉCHAPPEMENT	1
14	REC60930	60930	PALOMILLA ESCAPE	SHUTTER WATER EXHAUST	FARFALLA SCARICO	CLAPET ÉCHAPPEMENT	1
15	PAGB/T93-10	13-41471	ARANDELA	LOCKWASHER	RONDELLA	RONDELLE	4

165, 170, 180, 190, 470, 485, 488  
3.7L & 3.7LX MCM 224 CID 4 CYL (1980-89)

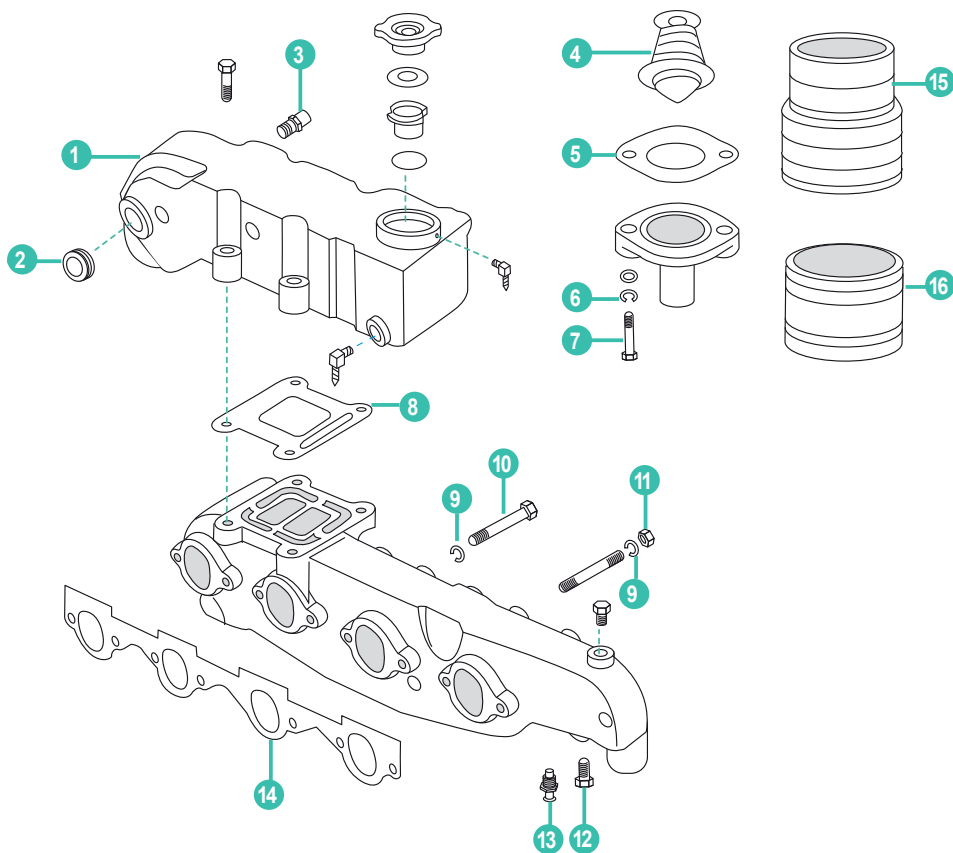
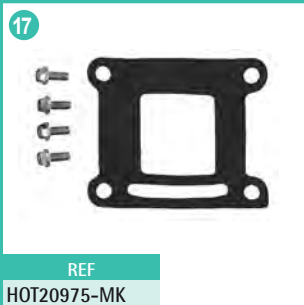

	REF	OEM				UN.	
1	HOT20937	98562A6	CODO PARA COLECTOR ALUMINIO	EXHAUST ELBOW FOR ALUM. MANIFOLD	GOMITO PER COLLETTORI IN ALLUMINO	COUDE D'ÉCHAPPEMENT AL	1
	HOT20905	90880A2	CODO PARA COLECTOR HIERRO	ELBOW FOR CAST. MANIFOLD	GOMITO PER COLLETTORI IN GHISA	COUDE D'ÉCHAPPEMENT FE	1
2	REC22-428611	22-428611	TAPÓN	CAP	TAPPO	BOUCHON	1
3	REC22-866725	22-866725	RACOR COLECTOR	HOSE FITTING	RACCORDO COLLETORE	RACCORD COLLECTEUR	1
4	REC99155T2	99155T2	TERMOSTATO	THERMOSTAT	TERMOSTATO	THERMOSTAT	1
5	REC27-89656-1	27-896561	JUNTA	GASKET	GUARNIZIONE	JOINT	1
6	REC13-39107	13-39107	ARANDELA	LOCKWASHER	CHIUSURA	RONDELLE	2
7	REC10-73657	10-73657	TORNILLO	SCREW	VITE	VIS	2
8	REC27-18272	27-18272	JUNTA CODO A COLECTOR	GASKET - ELBOW TO MANIFOLD	GUARNIZIONE COLLETORE GOMITO	JOINT COUDE À COLLECTEUR	1
	REC27-856705	27-856705	JUNTA COLECTOR DE HIERRO	GASKET FOR IRON MANIFOLD	GUARNIZIONE PER COLLETORE IN GHISA	JOINT COLLECTEUR FE	1
9	REC13-35048	13-35048	ARANDELA	LOCKWASHER	RONDELLA	RONDELLE	3
10	REC22-73379	10-74727	TORNILLO	SCREW	VITE	VIS	3
11	REC46335	46335	TUERCA	FLANGE SERRATED NUT	DADO	ÉCROU	1
12	REC22-32803	22-32803	TAPÓN	PLUG	TAPPO	BOUSCHON	1
13	REC15995	15995	SENSOR TEMPERATURA	TEMPERATURE SENDER	SENSORE TEMPERATURA	SONDE TEMPÉRATURE	1
14	REC27-68715	27-68715	JUNTA COLECTOR ESCAPE	GASKET - EXHAUST MANIFOLD	GUARNIZIONE COLLETORE SCARICO	JOINT COLLECTEUR D'ÉCHAPPEMENT	1
15	REC70981A3	70981A3	FUELLE ESCAPE	EXHAUST BELLOW	CUFFIA SCARICO	SOUFFLET D'ÉCHAPPEMENT	1
16	REC32-90949T	32-90949T	FUELLE ESCAPE	EXHAUST BELLOW	CUFFIA SCARICO	SOUFFLET D'ÉCHAPPEMENT	1
17	HOT20975-MK		KIT PARA COLECTOR DE FUNDICIÓN	KIT FOR CAST IRON MANIFOLD	KIT VITERIA PER COLLETTORI IN GHISA	KIT DE MONTAGE FE FORGÉ	
18	HOT20905-MK		KIT MONTAJE CODO	MOUNTING KIT ELBOW	KIT DI MONTAGGIO GOMITO	KIT DE MONTAGE COUDE	
			HOT20905	HOT20905	HOT20905	HOT20905	
19	HOT20937-MK		KIT MONTAJE CODO	MOUNTING KIT ELBOW	KIT DI MONTAGGIO GOMITO	KIT DE MONTAGE COUDE	
			HOT20937	HOT20937	HOT20937	HOT20937	



GM 160, 165, 200CID, 250, 292CID  
6 CYL IN LINE

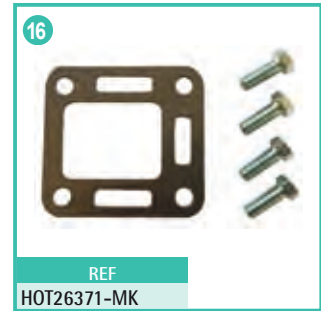
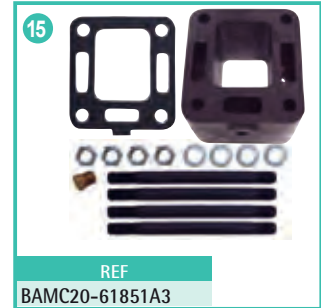
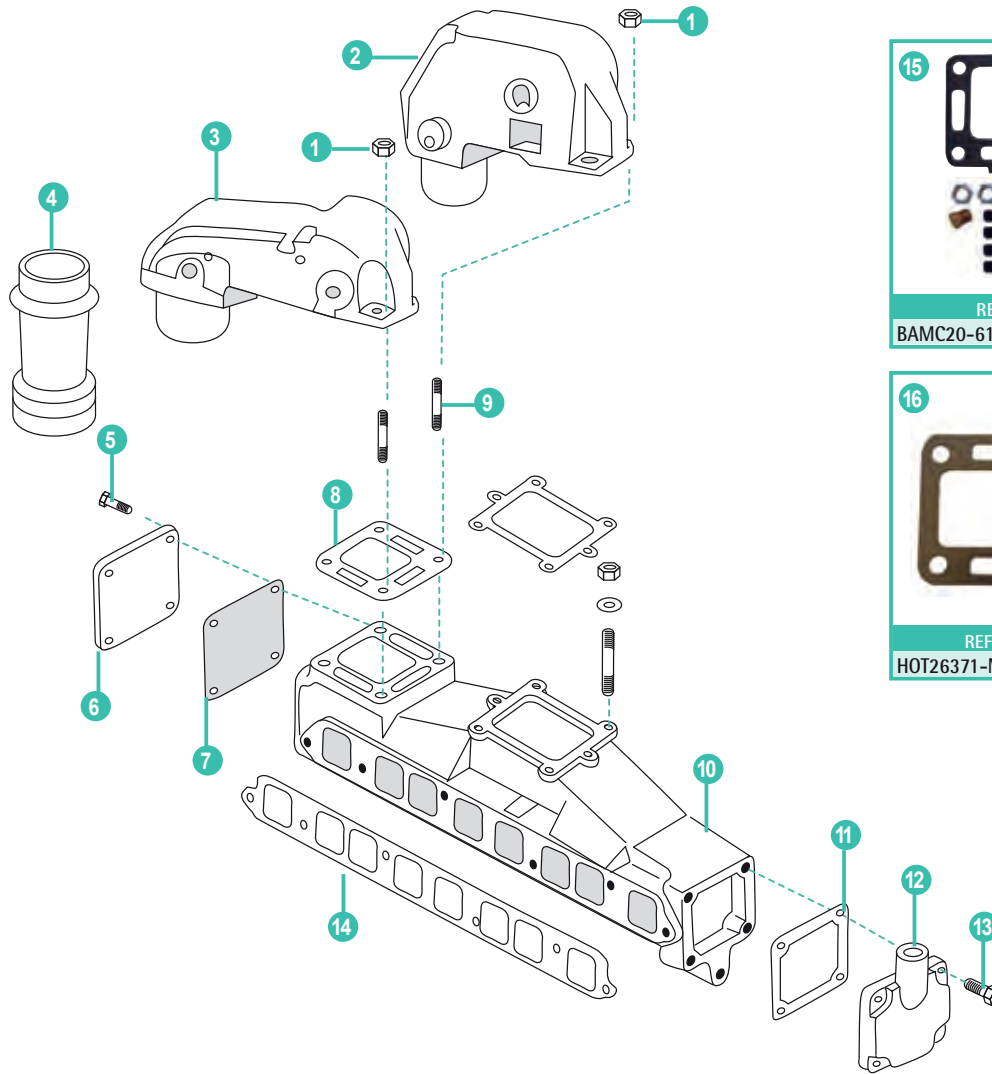

	REF	OEM				UN.	
1	REC46335	46335	TUERCA	NUT	DADO	ÉCROU	4
2	HOT20971	76351A04	CODO ESCAPE 90° 3"	EXHAUST ELBOW ASSY 3" 90°	GOMITO DI SCARICO 90° 3"	COUDE D'ÉCHAPPEMENT 90° 3"	1
3	REC76325A2	76325A2	CODO ESCAPE 90° 3"	EXHAUST ELBOW ASSY 3" 90°	GOMITO DI SCARICO 90° 3"	COUDE D'ÉCHAPPEMENT 90° 3"	1
4	REC53114A1	53114A1	FUELLE ESCAPE	EXHAUST BELLOW	CUFFIA DI SCARICO	SOUFFLET D'ÉCHAPPEMENT	1
5	RM10-25299	10-824941	TORNILLO	SCREW END CAP	VITE	VIS	4
6	HGE4870	73813A1	TAPA COLECTOR ESCAPE	END CAP EXHAUST MANIFOLD	COPERCHIO COLLETORE SCARICO	COUVERCLE COLLECTEUR D'ÉCHAPPEMENT	1
7	REC27-807218	27-807218	JUNTA TAPA	GASKET END CAP	GUARNIZIONE COPERCHIO	JOINT DE COUVERCLE	1
8	REC27-99777Q02	27-99777Q02	JUNTA COLECTOR A CODO	GASKET EXHAUST MANIFOLD TO ELBOW	GUARNIZIONE INTERMEDIA	JOINT COLLECTEUR À COUDE	1
9	REC16-49545	16-49545	ESPÁRRAGO	STUD	PRIGIONIERO	GOUJON	4
10	BAMC-1-58759	58759A14	COLECTOR ESCAPE	EXHAUST MANIFOLD ASSEMBLY	COLLETORE SCARICO	COLLECTEUR D'ÉCHAPPEMENT	1
11	REC27-480431	27-480431	JUNTA TAPA	GASKET END CAP	GUARNIZIONE COPERCHIO	JOINT COUVERCLE	1
12	REC60252A2	60252A2	TAPA COLECTOR	END CAP EXHAUST MANIFOLD	COPERCHIO COLLETORE	COUVERCLE COLLECTEUR	1
13	REC10-37562	10-37562	TORNILLO	SCREW	VITE	VIS	4
14	FEL17319	27-46401	JUNTA COLECTOR ADMISION/ESCAPE	GASKET INTAKE/EXHAUST MANIFOLD	GUARNIZIONE COLLETORE ASPIRAZIONE / SCARICO	JOINT COLLECTEUR ADMISSION/ÉCHAPPEMENT	1
15	BAMC20-61851A3		KIT SUPLEMENTO CODO DE 76mm	RISE MOUNTING KIT 3"	KIT DISTANZIALI GOMITO DA 76 mm	KIT REHAUSSE 3"	
16	HOT26371-MK		KIT MONTAJE CODO HOT26371	MOUNTING KIT ELBOW HOT26371	KIT DI MONTAGGIO GOMITO HOT26371	KIT MONTAGE COUDE HOT20371	

175, 185, 205, 262 MAG, 4.3L, 4.3LX, 4.3LH, 4.3LXH, 4.3 EFI, 4.3 MPI, GM 262 CID V6

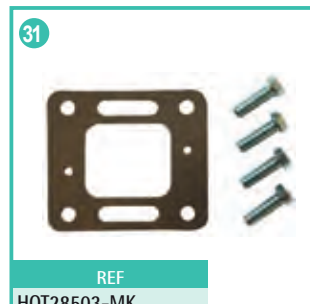
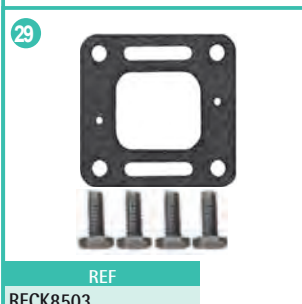
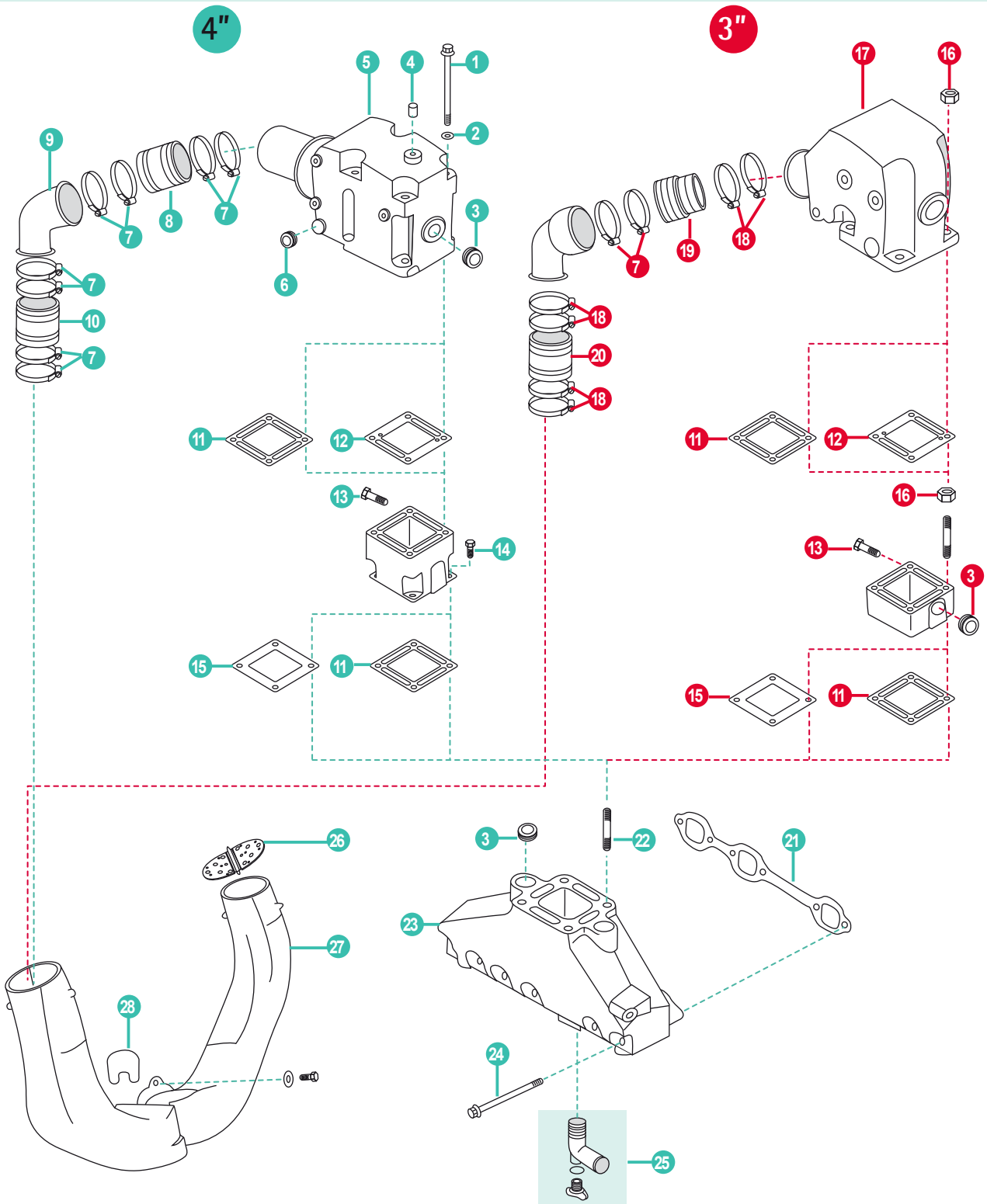

	REF	OEM					UN.
1	REC10-43749	10-43749	TORNILLO	SCREW	VITE	VIS	4
2	REC13-35048	13-35048	ARANDELA CIERRE	LOCKWASHER	CHIUSURA	RONDELLE	4
3	REC22-41622	22-41622	TAPÓN ACERO	PLUG (STEEL)	TAPPO IN ACCIAIO	BOUCHON EN ACIER	2
	REC22-428611	22-428611	TAPÓN BRONCE	PLUG (BRASS)	TAPPO IN BRONZO	BOUCHON EN BRONZE	2
4	REC22-73379	22-73379	TAPÓN	PLUG	TAPPO	BOUCHON	1
5	MAR988	807988A03	CODO 4" 7°	ELBOW 4" 7°	GOMITO 4" 7°	COUDE 4" 7°	1
	SED3092600	807988A3	CODO INOX	ELBOW INOX	GOMITO INOX	COUDE INOX	1
6	REC22-36382	22-36382	TAPÓN	PLUG	TAPPO	BOUCHON	1
7	GS38322	54-815504372	ABRAZADERA	CLAMP	FASCETTA	COLLIER	8
8	REC32-44348001	32-44348001	FUELLE ESCAPE 4"	EXHAUST BELLOW 4"	CUFFIA DI SCARICO 4"	SOUFFLET D'ÉCHAPPEMENT 4"	1
9	BAMC-20-14478	14478T01	TUBO 4"	TUBE 4"	TUBO 4"	TUYAU 4"	1
10	REC32-14358001	32-14358001	FUELLE ESCAPE	EXHAUST BELLOW	CUFFIA DI SCARICO	SOUFFLET D'ÉCHAPPEMENT	1
11	REC27-863726	27-863726	JUNTA	GASKET MANIFOLD	GUARNIZIONE	JOINT COLLECTEUR	1
12	REC27-863724Q	27-863724Q	JUNTA COLECTOR REESTRICTOR	GASKET MANIFOLD FOR RAW WATER	GUARNIZIONE PER CIRCUITO	JOINT DE COUDE D'ÉCHAPPEMENT	1
13	REC22-328022	22-328022	TAPÓN	PLUG	TAPPO	BOUCHON	1
14	REC10-865982005	10-865982005	TORNILLO	SCREW	VITE	VIS	4
15	REC27-8637251	27-8637251	JUNTA COLECTOR CIRCUITO AGUA DULCE	GASKET MANIFOLD FOR FRESH WATER COOLING	GUARNIZIONE PER CIRCUITO CHIUSO	JOINT DE COUDE D'ÉCHAPPEMENT	1
16	REC46335	46335	TUERCA CODO	NUT FLANGE SERRATED NUT	DADO GOMITO	ÉCROU COUDE	4
17	REC98504A3	98504A3	CODO 3" 15°	ELBOW 3" 15°	GOMITO 3" 15°	COUDE 3" 15°	1
18	GS38320	54-815504256	ABRAZADERA	CLAMP	FASCETTA	COLLIER	6
19	REC70981A3	70981A3	FUELLE ESCAPE 3"	EXHAUST BELLOW 3"	CUFFIA DI SCARICO 3"	SOUFFLET D'ÉCHAPPEMENT 3"	1
20	REC32-90949T	32-90949T	FUELLE ESCAPE 3"	EXHAUST BELLOW 3"	CUFFIA DI SCARICO 3"	SOUFFLET D'ÉCHAPPEMENT 3"	1
21	REC27-99757	27-99757	JUNTA COLECTOR	GASKET EXHAUST MANIFOLD	GUARNIZIONE COLLETORE	JOINT COLLECTEUR D'ÉCHAPPEMENT	1
22	REC16-49545	16-49545	ESPARRAGO DE ACERO	STUD (STEEL)	PRIGIONIERO IN ACCIAIO	GOUJON EN ACIER	4
23	MAR746	99746A17	COLECTOR	MANIFOLD	COLLETORE	COLLECTEUR	1
24	REC10-53728	10-53728	TORNILLO	SCREW	VITE	VIS	6
25	REC862210A01	22-862210A01	KIT TAPÓN Y CONDUCTO	HOSE FITTING WITH DRAIN PLUG KIT	KIT TAPPO E CONDOTTO	KIT BOUCHON ET TUBE	1
26	REC807166A1	807166A1	PALOMILLA ESCAPE	WATER SHUTTER	FARFALLA SCARICO	CLAPET ÉCHAPPEMENT	1
27	RM807130A4	807130A4	CUERNOS DE ESCAPE	EXHAUST PIPE	CORNA DI SCARICO	CORNE D'ÉCHAPPEMENT	1
28	REC41802	41802	JUNTA	GASKET	GUARNIZIONE	JOINT	1
29	RECK8503		KIT TORNILLOS CODO	EXHAUST ELBOW MOUNTING KIT	KIT VITI GOMITO	KIT VITI GOMITO	
30	HOT20952-MK		KIT MONTAJE PARA HOT20952	MOUNTING KIT ELBOW HOT20952	KIT MONTAGGIO GOMITO HOT20952	KIT DE MONTAGE HOT20952	
31	HOT28503-MK		KIT MONTAJE PARA HOT20970	MOUNTING KIT ELBOW HOT20970	KIT MONTAGGIO GOMITO HOT20970	KIT DE MONTAGE HOT20970	
32	HOT20976-MK		KIT MONTAJE PARA MAR988	MOUNTING KIT ELBOW MAR988	KIT MONTAGGIO GOMITO MAR988	KIT DE MONTAGE MAR988	
33	REC32175		KIT TORNILLOS Y JUNTAS COLECTOR V6	EXHAUST MANIFOLD MOUNTING KIT	KIT VITE E GUARNIZIONI COLLETORE V6	KIT VISSERIE COLLECTEUR V6 + JOINT	
34	REC53400		KIT TORNILLOS CODO Y JUNTA	EXHAUST ELBOW MOUNTING KIT	KIT VITI GOMITO	KIT VISSERIE POUR COUDE	
35	HOT20985	93322A12AV	KIT ELEVADOR 152 mm	6" RISER KIT	KIT DISTANZIALE 152mm	KIT REHAUSSE 6"	
36	MAR3320PAR	93320A13	KIT ELEVADOR 76 mm	3" RISER KIT	KIT DISTANZIALE 76 mm	KIT REHAUSSE 3"	

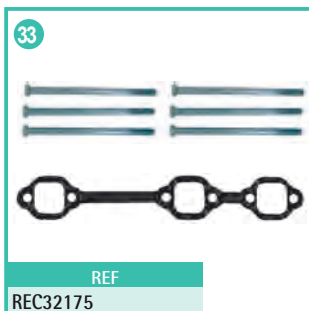

4.3L CARB MPI ALPHA/BRAVO

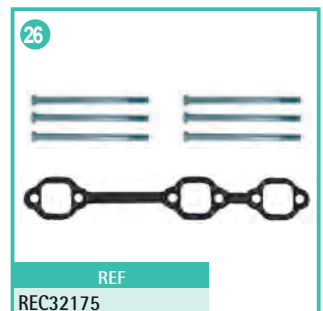
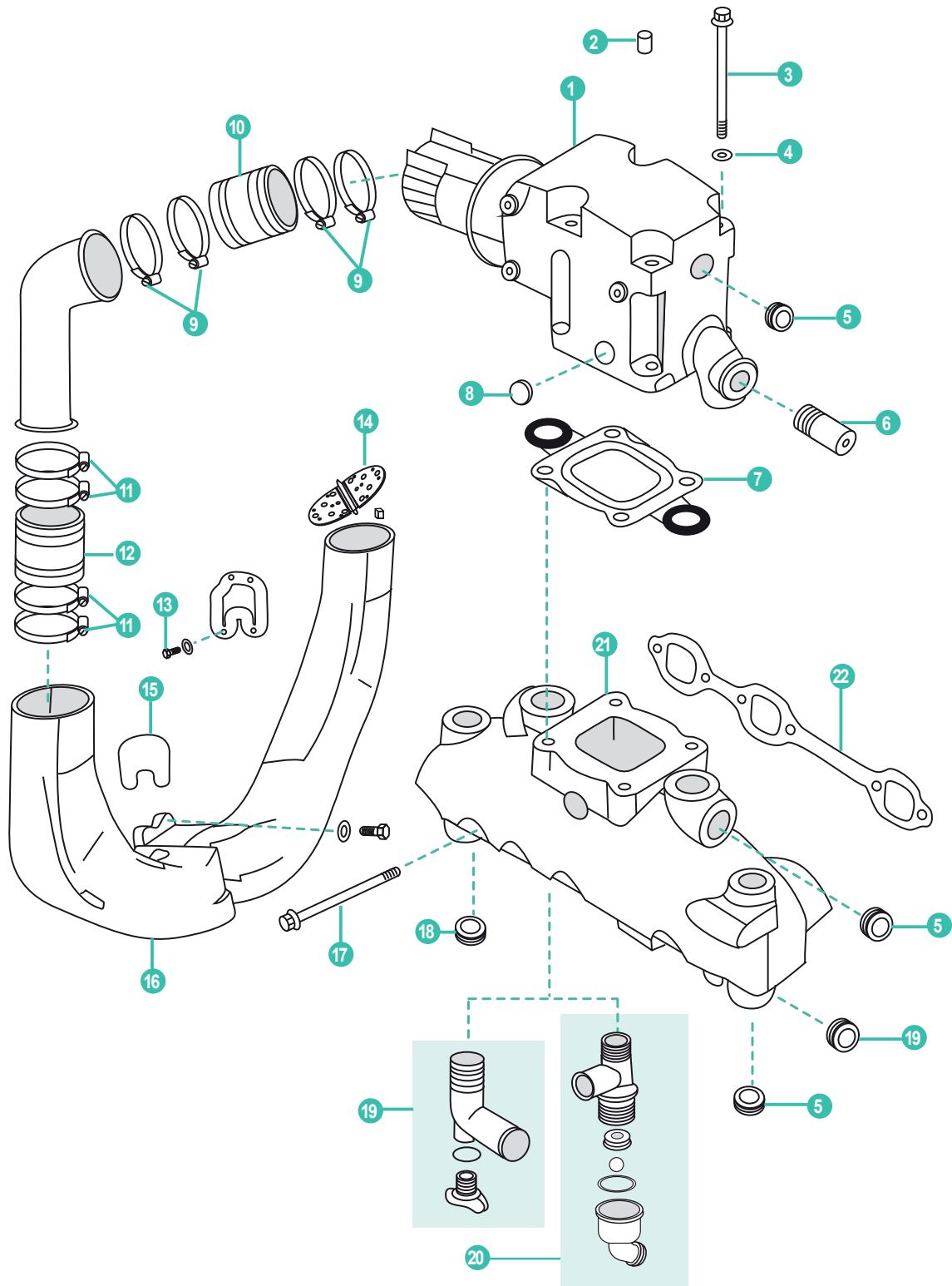



	REF	OEM					UN.
	MAR309	864309T02	CODO BAJO 17 cm	ELBOW LOW 17 cm	GOMITO BASSO 17 cm	COUDE BASSE 17 cm	2
1	MAR591	864591T02	CODO ALTO 20,5 cm	ELBOW HIGH 20,5 cm	GOMITO ALTO 20,5 cm	COUDE HAUT 20,5 cm	2
	SED3095400	864309T02	CODO BAJO INOX	ELBOW LOW SS	GOMITO BASSO INOX	COUDE BASSE INOX	2
	SED3095500	864591T02	CODO ALTO INOX	ELBOW HIGH SS	GOMITO ALTO INOX	COUDE HAUT INOX	2
2	REC22-73379	22-73379	TAPÓN	PLUG	TAPPO	BOUCHON	1
3	REC10-43749	10-43749	TORNILLO	SCREW	VITE	VIS	8
4	REC13-35048	13-35048	ARANDELA	LOCK WASHER	RONDELLA	RONDELLE	8
5	REC22-428611	22-428611	TAPÓN	FITTING	TAPPO	BOUCHON	8
6	REC22-866725	22-866725	RACORD COLECTOR	STRAIGHT FITTING	RACCORD COLLETTORE	RACCORD COLLECTEUR	1
7	REC270	27-684547A02	JUNTA CODO - COLECTOR	ELOW-MANIFOLD GASKET	GUARNIZIONE INTERMEDIA	JOINT DE COUDE ECHAPPEMENT	1
8	REC19-864689	19-864689	TAPÓN	PLUG	TAPPO	BOUCHON	2
9	GS38310	54-815504456	ABRAZADERA	CLAMP	FASCETTA	COLLIER	8
10	REC32-44348001	32-44348001	FUELLE ESCAPE	EXHAUST BELLOW	MANICOTTO SCARICO	SOUFFLET D'ÉCHAPPEMENT	2
11	GS38320	54-815504456	ABRAZADERA	CLAMP	FASCETTA	COLLIER	8
12	REC32-14358001	32-14358001	FUELLE ESCAPE COLECTOR	EXHAUST BELLOW	MANICOTTO SCARICO COLLETTORE	SOUFFLET D'ÉCHAPPEMENT COLLECTEUR	2
13	REC10-98794	10-98794	TORNILLO	SCREW COVER	VITE	VIS	4
14	REC807166A1	807166A1	PALOMILLA ESCAPE	WATER SHUTTER	FARFALLA SCARICO	CLAPET ÉCHAPPEMENT	2
15	REC41802	41802	RETÉN TRANSON	TRANSON GASKET	GUARNIZIONE TRANSON	JOINT DE TRANSON	1
16	RM807130A4	807130A4	CUERNOS DE ESCAPE	EXHAUST PIPE	CORNA DI SCARICO	CORNE D'ÉCHAPPEMENT	1
17	REC10-53728	10-53728	TORNILLO	SCREW	VITE	VIS	6
18	PAF15-07010004	479452	TAPÓN 1/8"	PLUG 1/8"	TAPPO 1/8"	BOUCHON 1/8"	1
19	REC862210A01	22-862210A01	KIT TAPÓN Y CONDUCTO	ELBOW AND PLUG KIT	KIT TAPPO E TUBO	COUDE DRAIN POUR COLLECTEUR	1
20	REC22-863786A1		CONECTOR	DRAIN FITTING	CONNETTORE	CONNECTEUR T	
21	MAR612	864612T01	COLECTOR	MANIFOLD	COLLETTORE	COLLECTEUR	2
22	REC27-99757	27-99757	JUNTA COLECTOR	MANIFOLD GASKET	GUARNIZIONE COLLETTORE	JOINT COLLECTEUR	2
23	RECK309		KIT TORNILLOS CODO Y JUNTA	ELBOW GASKET & BOLT KIT	KIT VITERIA GOMITO E GUARNIZIONE	KIT DE MONTAGE	
24	REC270		KIT JUNTA CODO-COLECTOR	ELBOW-MANIFOLD GASKET	GUARNIZIONE GOMITO- COLLETTORE	JOINT DE COUDE ÉCHAPPEMENT	
25	RECK591		KIT PARA MAR591	KIT FOR MAR591	KIT PER MAR591	KIT POUR MAR591	
26	REC32175		KIT TORNILLOS COLECTOR Y JUNTA	MANIFOLD GASKET & ELBOW KIT	KIT VITERIA COLLETTORE E GUARNIZIONE	KIT VISSERIE COLLECTEUR V6 + JOINT	
27	MAR929 HGE4929	864929A3	KIT RISER 3"	KIT RISER 3"	KIT GOMITO 3"	KIT REHAUSSE 3"	
28	BAMC-20-864908A1	864908A1	KIT RISER 6"	KIT RISER 6"	KIT GOMITO 6"	KIT REHAUSSE 6"	

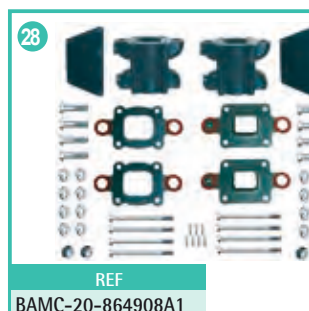

262 MAG (TBI), 4.3L (GEN+), 4.3 L EFI (GEN+), 4.3 LH (GEN+), 4.3LX (GEN+), GM 262 V6 (1996-01)

PIEZAS NECESARIAS PARA  
SUBSTITUIR EL COLECTOR-CODO  
PARA V6

NEEDS PARTS TO REPLACE V6  
MANIFOLD-ELBOW

PEZZI NECESSARI PER SOSTITUIRE IL  
COLLETTORE PER V6

PIÈCES NÉCESSAIRES POUR  
REMPLENER LE COLLECTEUR-COUDE  
POUR V6

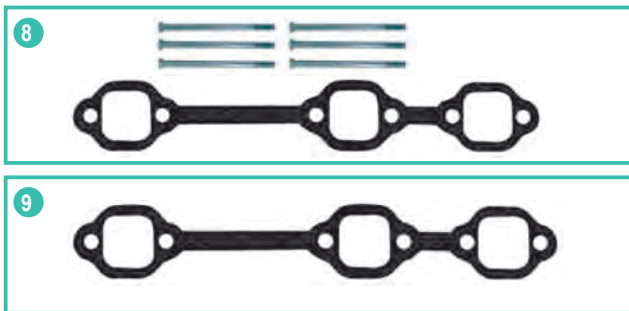

	REF	OEM					UN.
1	MAR988	807988A03	CODO 4"	ELBOW 4"	GOMITO 4"	COUDE 4"	2
2	REC32-44348001	32-44348001	FUELLE ESCAPE SUPERIOR	UPPER EXHAUST BELLOW	CUFFIA SCARICO SUPERIORE	SOUFFLET ECHAPPEMENT SUPERIEUR	2
3	REC32-14358001	32-14358001	FUELLE ESCAPE INFERIOR	LOWER EXHAUST BELLOW	CUFFIA SCARICO INFERIORE	SOUFFLET ECHAPPEMENT INFÉRIEUR	2
4	MAR746	99746A17	COLECTOR	MANIFOLD	COLLETTORE	COLLECTEUR	2
5	BAMC-20-14478	14478T01	CURVA ESCAPE V6	EXHAUST ELBOW ASSY	CURVA SCARICO V6	COUDE DE CONVERSION V6/262	2
6	REC862210A01	22-862210A01	KIT TAPÓN Y CONDUCTO	HOSE FITTING W/DRAIN PLUG KIT	KIT RUBINETTO	COUDE DRAIN POUR COLLECTEUR	2
7	GS38322	54-815504372	ABRAZADERA INOX	INOX CLAMP	FASCETTA INOX	COLLIER INOX	8
8	REC32175		KIT JUNTA Y TORNILLOS	GASKETS & BOLTS KIT	KIT VITERIA E GUARNIZIONI	KIT VISSERIE COLLECTEUR V6 + JOINT	2
9	REC27-99757	27-99757	JUNTA COLECTOR (X1)	MANIFOLD'S GASKET (X1)	GUARNIZIONE (X1)	KIT JOINTS COLLECTEUR ECHAPPEMENT (X1)	2
10	REC53400		KIT JUNTAS CODOS Y TORNILLOS	BOLTS & ELBOWS GASKETS KITS	KIT VITERIA E GUARNIZIONI	KIT VISSERIE POUR COUDE MAR988	2

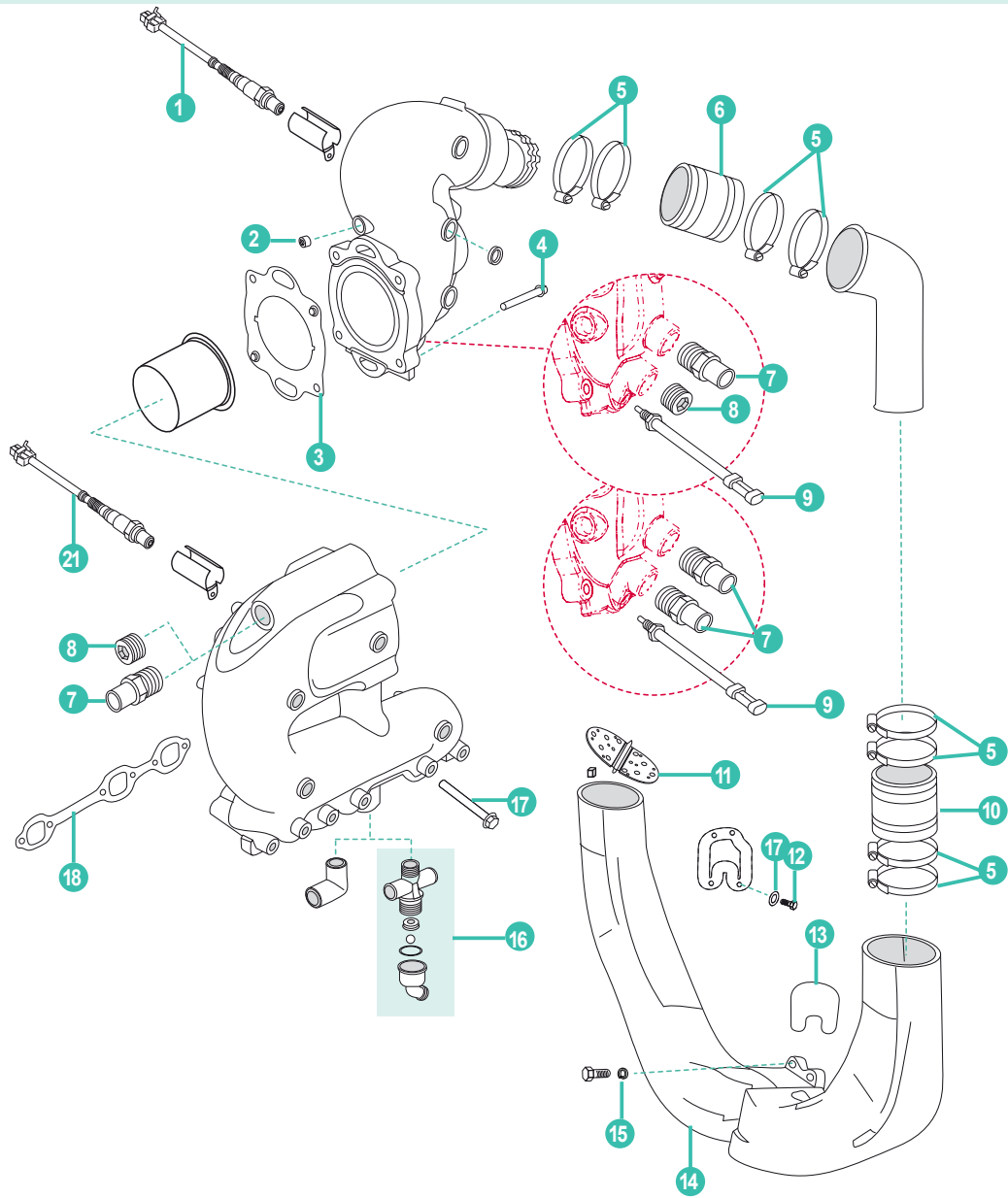

	REF	OEM				UN.	
1	REC8M2003959	8M2003959	SENSOR OXÍGENO	OXYGEN SENSOR	SENSORE O2	SENSEUR O2	2
2	REC22-73379	73379	TAPÓN	PLUG	TAPPO	BOUCHON	
3	REC8M2004414	8M2004414	JUNTA (STANDARD COOLING)	GASKET	GUARNIZIONE	JOINT	2
4	REC10-668631	668631	TORNILLO	SCREW	VITE	VIS	4
5	GS38320	815504272	ABRAZADERA	CLAMP	FASCETTA	COLLIER	16
6	REC32-44348001	44348001	TUBO ESCAPE	EXHAUST TUBE	TUBO SCARICO	DURITE D'ÉCHAPPEMENT	2
7	REC22-866725	866725	RACOR COLECTOR	FITTING STRAIGHT	RACCORDO COLLETTORE	RACCORD COLLECTEUR	2 (3)
8	REC22-428611	428611	TAPON CODO LATON	FITTING PIPE. BRASS	TAPPO GOMITO OTTONE	BOUCHON DE COUDE EN LAITON	2
9	REC8M0148668	885342002	SENSOR	SENDER	SENSORE	SENSEUR	2
10	REC32-14358001	14358001	TUBO ESCAPE	EXHAUST TUBE	TUBO SCARICO	DURITE D'ÉCHAPPEMENT	2
11	REC807166A1	807166A1	PALOMILLA	SHUTTER ASSY WATER	FARFALLA	CLAPET	2
12	REC10-98794	98794	TORNILLO	SCREW	VITE	VIS	4
13	REC41802		JUNTA	GASKET	GUARNIZIONE	JOINT	1
14	RM807130A4	8M0115149	CUERNO ESCAPE	PIPE EXHAUST	CORNA DI SCARICO	CORNE D'ÉCHAPPEMENT	1
15	PAGB/T93-10	41471	ARANDELA	LOCKWASHER	RONDELLA	RONDELLE	8
16	REC8M0095953	8M0095953	CONECTOR	FITTING ASSY (STD COOLING)	CONNECTOR	CONNECTEUR	2
17	REC10-53728	8M2000229	TORNILLO	SCREW	VITE	VIS	6
18	REC27-99757	99757	JUNTA	GASKET	GUARNIZIONE	JOINT	1
19	REC8M0142695	8M0095468	SENSOR OXÍGENO	OXYGEN SENSOR	SENSORE O2	SENSEUR O2	2

305, 350, 377, 383, 385, (6.2L)  
MAG MPI HORIZON ALPHA/BRAVO

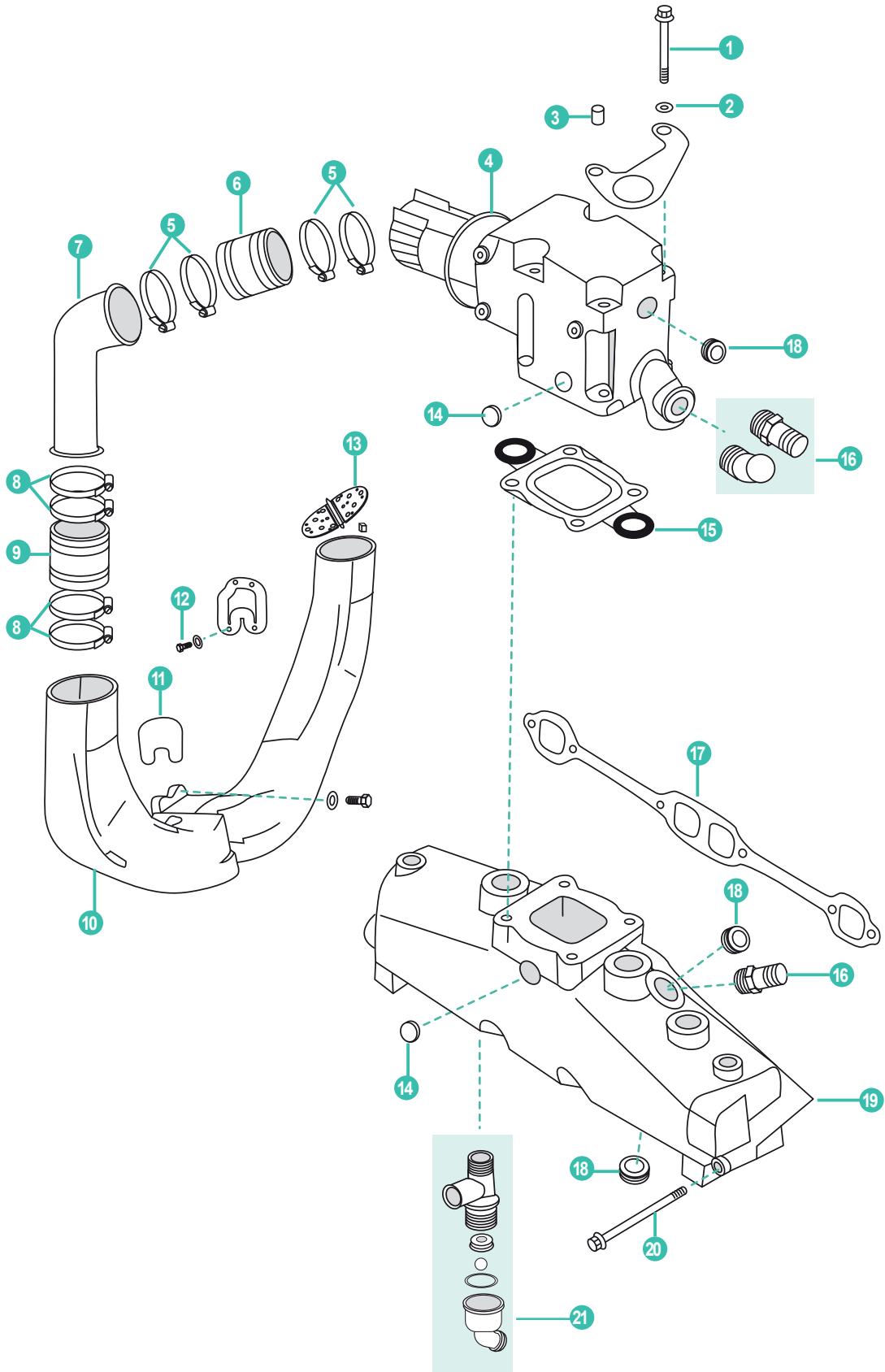



	REF	OEM					UN.
1	REC10-43749	10-43749	TORNILLO	SCREW	VITE	VIS	8
2	REC13-35048	13-35048	ARANDELA	WASHER	RONDELLA	RONDELLE	8
3	REC22-73379	22-73379	TAPÓN	PLUG	TAPPO	BOUCHON	1
	MAR309	864309T02	CODO BAJO 17 cm	ELBOW LOW 17 cm	GOMITO BASSO 17 cm	COUDE BASSE 17 cm	2
4	MAR591	864591T02	CODO ALTO 20,5 cm	ELBOW HIGH 20,5 cm	GOMITO ALTO 20,5 cm	COUDE HAUTE 20,5cm	2
	SED3095400	864309T02	CODO BAJO INOX	ELBOW LOW SS	GOMITO BASSO INOX	COUDE BASSE INOX	2
	SED3095500	864591T02	CODO ALTO INOX	ELBOW HIGH SS	GOMITO ALTO INOX	COUDE HUATE INOX	2
5	GS38310	54-815504456	ABRAZADERA	CLAMP	FASCETTA	COLLIER	8
6	REC32-44348001	32-44348001	FUELLE ESCAPE	EXHAUST BELLOW	MANICOTTO SCARICO	SOUFFLER ÉCHAPPEMENT	2
7	RM14801A1	14801A1	KIT SUPLEMENTOS	KIT RISER	KIT DISTANZIALE	KIT HAUSSEUR	1
8	GS38320	54-815504272	ABRAZADERA	CLAMP	FASCETTA	COLLIER	8
9	REC32-14358001	32-14358001	FUELLE ESCAPE COLECTOR	EXHAUST BELLOW	MANICOTTO SCARICO COLLETORE	SOUFFLET ÉCHAPPEMENT COLLECTEUR	2
10	RM807130A4	807130A4	CUERNOS DE ESCAPE	EXHAUST PIPE	CORNA DI SCARICO	CORNE D'ÉCHAPPEMENT	1
11	REC41802	41802	RETÉN TRANSOM	TRANSOM GASKET	GUARNIZIONE TRANSOM	JOINT TRANSOM	1
12	REC10-98794	10-98794	TORNILLO	SCREW COVER	VITE	VIS	4
13	REC807166A1	807166A1	PALOMILLA ESCAPE	WATER SHUTTER	FARFALLA SCARICO	CLAPET ÉCHAPPEMENT	2
14	REC19-864689	19-864689	TAPÓN	PLUG	TAPPO	BOUCHON	6
15	REC270		JUNTA CODO - COLECTOR	ELBOW-MANIFOLD GASKET	GUARNIZIONE INTERMEDIA	JOINT COUDE - COLLECTEUR	1
16	REC22-866725	22-866725	RACORD COLECTOR	STRAIGHT FITTING	RACCORD COLLETORE	RACCORD COLLECTEUR	1
	REC27-33395	27-33395	JUNTA COLECTOR	MANIFOLD GASKET	GUARNIZIONE COLLETORE	JOINT COLLECTEUR	2
17	FEL17420	27-33395	KIT JUNTAS COLECTOR	MANIFOLD GASKET KIT	KIT GUARNIZIONE COLLETORE	KIT JOINTS COLLECTEUR	1
18	REC22-428611	22-428611	TAPÓN	PLUG	TAPPO	BOUCHON	4
19	MAR735	865735A02	COLECTOR	MANIFOLD	COLLETORE	COLLECTEUR	2
20	REC10-53728	10-53728	TORNILLO	SCREW	VITE	VIS	8
21	REC22-863786A1	22-863786A1	CONECTOR	FITTING	CONNECTOR	CONNECTEUR	
22	RECK309		KIT TORNILLOS CODO Y JUNTA	ELBOW GASKET & BOLT KIT	KIT VITERIA GOMITO E GUARNIZIONE	KIT DE MONTAGE	
23	REC270	27-864547A02	KIT JUNTA CODO-COLECTOR	ELBOW-MANIFOLD GASKET	GUARNIZIONE GOMITO-COLLETORE	JOINT DE COUDE ÉCHAPPEMENT	
24	RECK591		KIT PARA MAR591	KIT FOR MAR591	KIT PER MAR591	KIT POUR MAR591	
25	MAR929 HGE4929	864929A3	KIT RISER 3"	KIT RISER 3"	KIT GOMITO 3"	KIT REHAUSSE 3"	
26	BAMC-20-864908A1	864908A1	KIT RISER 6"	KIT RISER 6"	KIT GOMITO 6"	KIT REHAUSSE 6"	

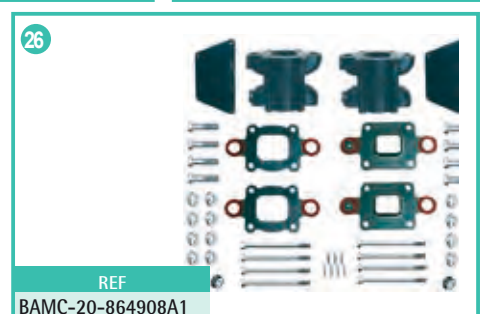

# V8 SMALL BLOCK

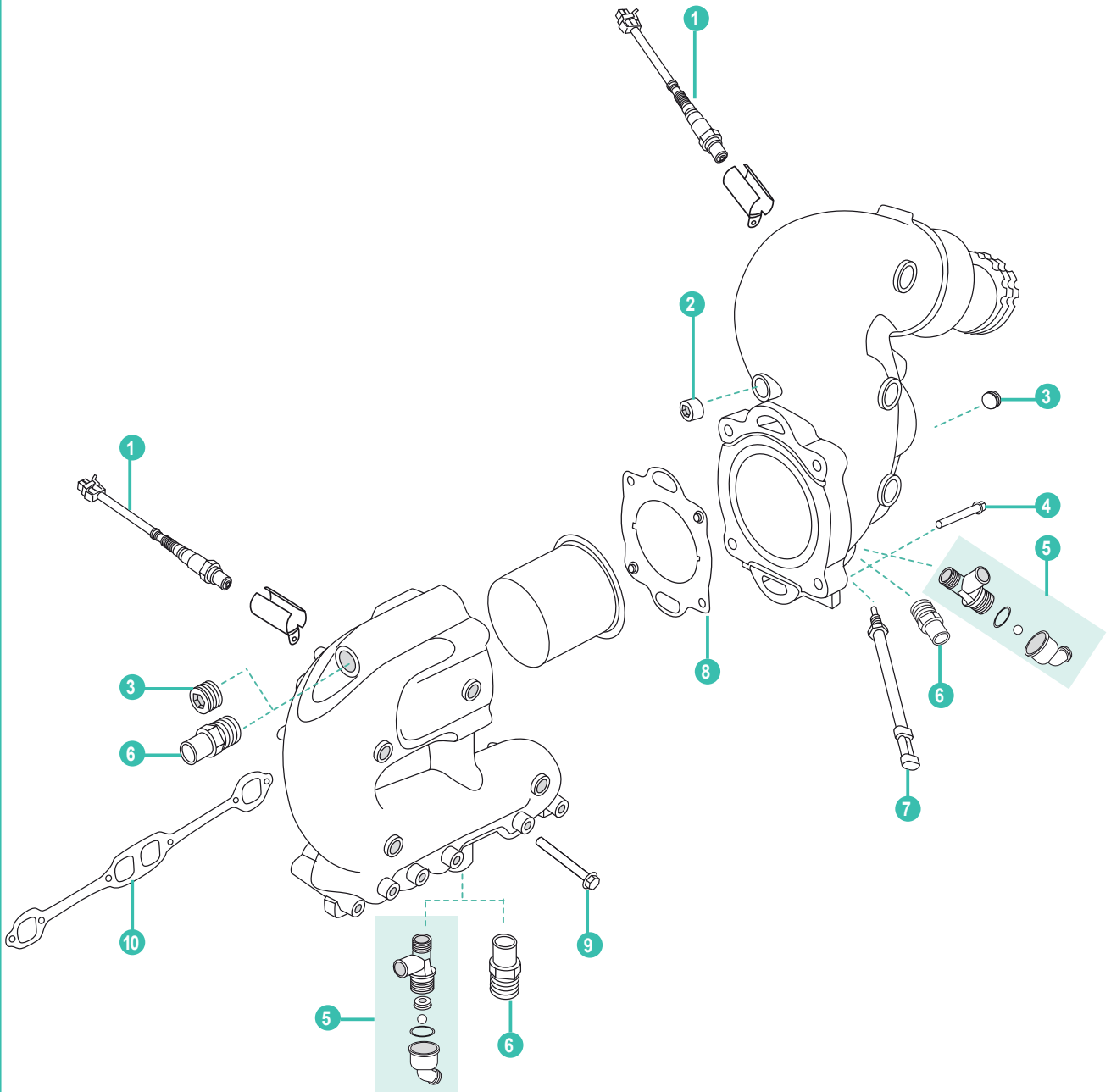

	REF	OEM					UN.
1	REC8M2003959	8M2003959	SENSOR OXÍGENO	O2 SENSOR	SENSORE O2	SENSEUR O2	4
2	REC22-73379	73379	TAPON	PLUG	TAPPO	BOUCHON	
3	REC22-428611	428611	TAPON CODO LATON	FITTING PIPE-BRASS	TAPPO GOMITO OTTONE	BOUCHON DE COUDE EN LAITON	2
4	REC10-668631	668631	TORNILLO	SCREW	VITE	VIS	8
5	REC22-863786A1	863786A1	CONECTOR	T FITTING ASSY	CONNETTORE	CONNECTEUR T	2
6	REC22-866725	866725	RACORD COLECTOR	FITTING STRAIGHT	RACCORD COLLETORE	RACCORD COLLECTEUR	2
7	REC8M0148668	885342002	SENSOR	SENSOR ASSY	SENSORE	SENSEUR	2
8	REC8M2004414	8M2004414	JUNTA CODO -COLECTOR	GASKET ELBOW-MAIFOLD	GUARNIZIONE GOMITO - COLLETORE	JOINT COUDE - COLLECTEUR	2
9	REC10-53728	8M2000229	TORNILLO	SCREW	VITE	VIS	12
10	REC27-33395	8M2000819	JUNTA COLECTOR ESCAPE	MANIFOLD GASKET	GUARNIZIONE COLLETORE SCARICO	JOINT DE COLLECTEUR D'ECHAPPEMENT	1

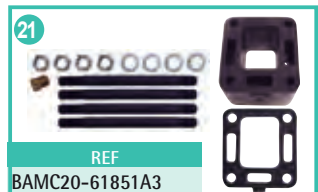
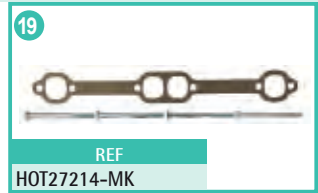
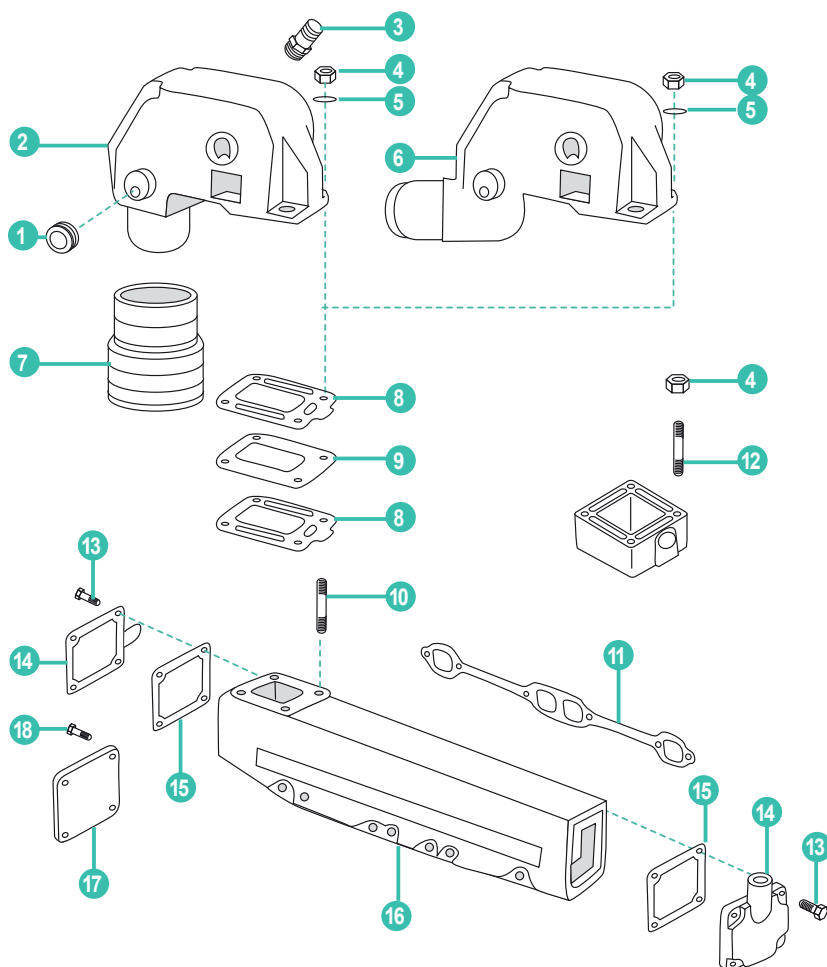

	REF	OEM				UN.	
1	REC22-41622	22-41622	TAPON CODO	ELBOW PLUG	TAPPO GOMITO	BOUCHON COUDE	2
2	HOT20971	76351A04	CODO 90°	EXHAUST ELBOW ASSY. 3" 90°	GOMITO 90°	COUDE 90°	1
3	REC22-866725	22-866725	RACORD COLECTOR	STRAIGHT FITTING	RACCORDO COLLETTORE	RACCORD COLLECTEUR	2
4	REC46335	46335	TUERCA CODO	FLANGE SERRATED NUT	DADO	ÉCROU	4
5	REC13-35048	13-35048	ARANDELA	WASHER	RONDELLA	RONDELLE	4
6	HOT20978 REC76771A2	76771A2	CODO 0°	EXHAUST ELBOW ASSY. 3" 0°	GOMITO 0°	COUDE 0°	1
7	REC70981A3	70981A3	FUELLE ESCAPE	EXHAUST BELOW	MANICOTTO SCARICO	SOUFFLET ÉCHAPPEMENT	2
8	REC27-99777Q02	27-99777Q02	JUNTA CODO	GASKET EXHAUST ELBOW	GUARNIZIONE COPERCHIO	JOINT COUDE	2
9	REC60207	60207	TAPA COLECTOR	PLATE	PIASTRA	PLAQUE DE COLLECTEUR	1
10	REC16-49545	16-49545	ESPÁRRAGO	STUD	PRIGIONIERO	GOUJON	4
11	REC27-33395 FEL17420	27-33395	JUNTA COLECTOR KIT JUNTAS COLECTOR	GASKET EXHAUST MANIFOLD EXHAUST MANIFOLD KIT	GUARNIZIONE COLLETTORE KIT GUARNIZIONI COLLETTORE	JOINT COLLECTEUR KIT JOINTS COLLECTEUR	1 1
12	REC16-97520	16-97520	ESPÁRRAGO	STUD	PRIGIONIERO	GOUJON	4
13	REC10-35386	10-35386	TORNILLO	SCREW END CAP	VITE	VIS	8
14	REC60252A2	60252A2	TAPA COLECTOR	END CAP EXHAUST MANIFOLD	COPERCHIO COLLETTORE	COUVERCLE COLLECTEUR	2
15	REC27-480431	27-480431	JUNTA TAPA	GASKET END CAP	GUARNIZIONE COPERCHIO	JOINT COUVERCLE	2
16	HOT20950	77234A7	COLECTOR BABOR	EXHAUST MANIFOLD PORT	COLLETTORE DI SINISTRA	COLLECTEUR D'ÉCHAPPEMENT	1
17	HGE4870	73813A1	TAPA COLECTOR	END CAP EXHAUST MANIFOLD	COPERCHIO COLLETTORE	COUVERCLE COLLECTEUR	1
18	RM10-25299	10-824941	TORNILLO	SCREW END CAP	VITE	VIS	4
19	HOT27214-MK		KIT TORNILLOS CODO Y JUNTA	ELBOW GASKET & BOLT KIT	KIT VITERIA GOMITO E GUARNIZIONE	KIT DE MONTAGE ET JOINT	
20	HOT26371-MK		KIT MONTAJE PARA HOT20971/8	MOUNTING KIT ELBOW HOT20971/8	KIT DI MONTAGGIO GOMITO HOT20971/8	KIT MONTAGE POUR HOT20971/8	
21	BAMC20-61851A3		KIT SUPLEMENTOS 3"	RISER 3"	KIT RISER 3"	KIT HAUSSEUR 3"	

200, 228, 230, 230 MIE, 5.0L, 5.0LX, 898, 5.0L MPI, GM305 CID, 260, 260 MIE, 320 EFI, 350 MAG, GM350 CID, 5.7L, 5.7LX, 6.2L MPI V8 (1983 + 2003)

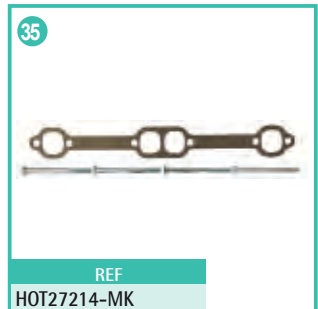
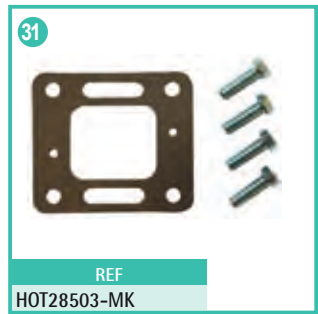
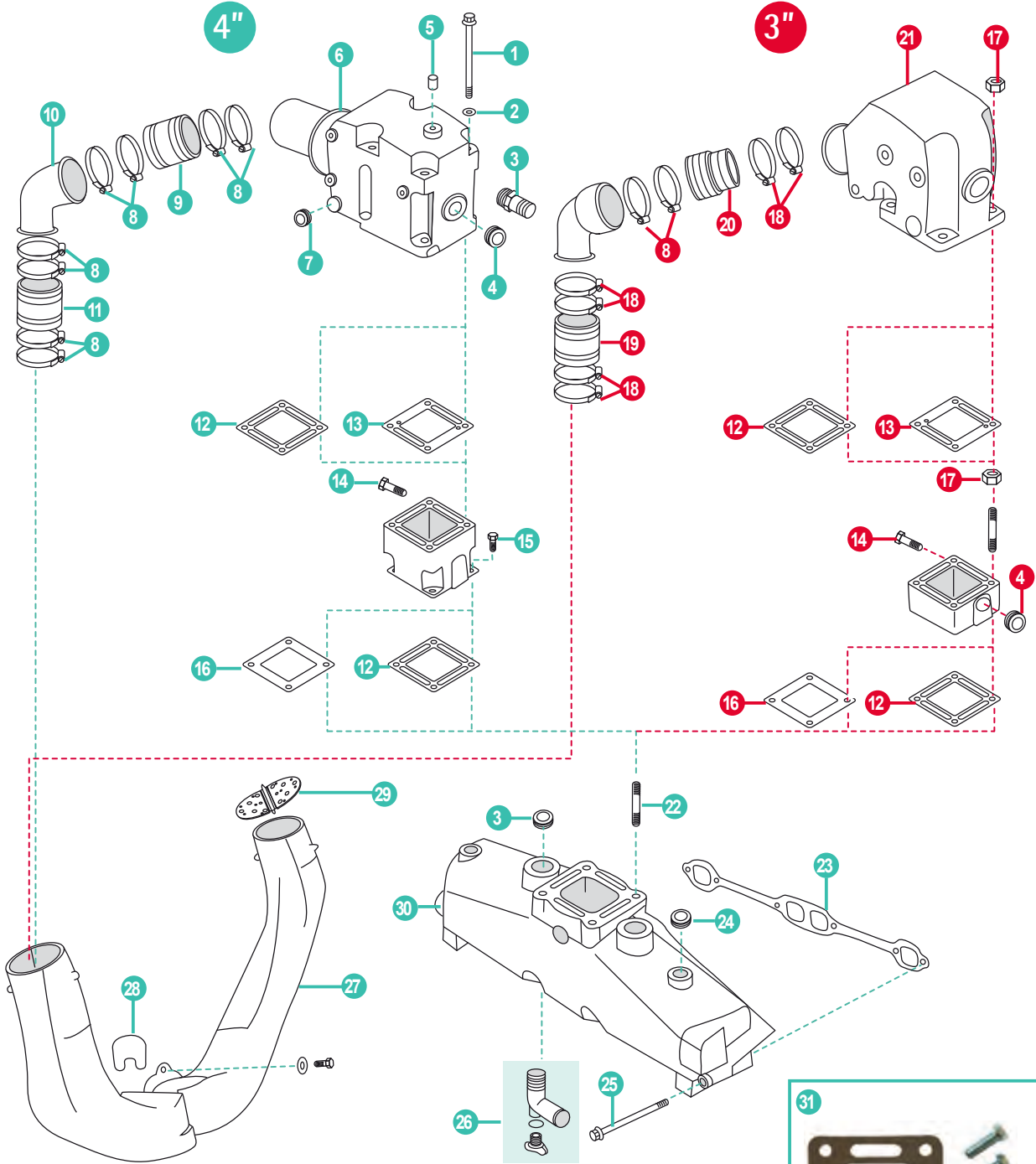



	REF	OEM				UN.	
1	REC10-43749	10-43749	TORNILLO ACERO	SCREW STEEL ZINC PLATED	VITE IN ACCIAIO	BOULON DE COUDE EN ACIER	4
2	REC13-35048	13-35048	CIERRE	LOCKWASHER	CHIUSURA	RONDELLE	4
3	REC22-866725	22-866725	RACORD COLECTOR	STRAIGHT FITTING	RACCORD COLLETORE	RACCORD COLLECTEUR	2
4	REC22-41622	22-41622	TAPÓN ACERO	PLUG (STEEL)	TAPPO IN ACCIAIO	BOUCHON EN ACIER	2
4	REC22-428611	22-428611	TAPÓN BRONCE	PLUG (BRASS)	TAPPO IN BRONZO	BOUCHON EN BRONZE	2
5	REC22-73379	22-73379	TAPÓN	PLUG	TAPPO	BOUCHON	1
6	MAR988	807988A03	CODO HIERRO	ELBOW (IRON CASTING) 4" 7°	GOMITO IN GHISA	COUDE FE 4" 7°	2
6	SED3092600		CODO INOX	ELBOW INOX 4" 7°	GOMITO INOX	COUDE INOX 4" 7°	2
7	REC22-36382	22-36382	TAPÓN	PLUG	TAPPO	BOUCHON	1
8	GS38322	54-815504372	ABRAZADERA	CLAMP	FASCETTA	COLLIER	1
9	REC32-44348001	32-44348001	FUELLE ESCAPE 4"	EXHAUST BELLOW 4"	CUFFIA SCARICO 4"	SOUFFLET ÉCHAPPEMENT 4"	1
10	BAMC-20-14478	14478T01	TUBO	TUBE	TUBO	TUYAU	1
10	RM14801A1	14801A1	KIT SUPLEMENTOS	KIR RISER	KIT DISTANZIALE	KIT HAUSSEUR	1
11	REC32-14358001	32-14358001	FUELLE ESCAPE 4"	EXHAUST BELLOW 4"	CUFFIA SCARICO 4"	SOUFFLET ÉCHAPPEMENT 4"	1
12	REC27-863726	27-863726	JUNTA COLECTOR Y ESPACIADORES	MANIFOLD AND SPACERS	GUARNIZIONE PER DISTANZIALE GASKET	JOINT COLLECTEUR ET HAUSSEURS	1
13	REC27-863724Q	27-863724Q	JUNTA COLECTOR CIRCUITO CERRADO	GASKET MANIFOLD RAW WATER COOLING	GUARNIZIONE COLLETORE CIRCUITO APERTO	JOINT DE COUDE D'ÉCHAPPEMENT	1
14	REC22-328022	22-328022	TAPÓN	CAP	TAPPO	BOUCHON	2
15	REC10-865982005	10-865982005	TORNILLO	SCREW	VITE	VIS	1
16	REC27-8637251	27-8637251	JUNTA COLECTOR CIRCUITO AGUA DULCE	GASKET MANIFOLD FOR FRESH WATER COOLING	GUARNIZIONE COLLETORE CIRCUITO CHIUSO	JOINT COLLECTEUR EAU FRÈICHE	1
17	REC46335	46335	TUERCA CODO	FLANGE SERRATED NUT	DADO GOMITO	ÉCROU COUDE	4
18	GS38320	54-815504256	ABRAZADERA	CLAMP	FASCETTA	COLLIER	1
19	REC32-90949T	32-90949T	FUELLE ESCAPE 3"	EXHAUST BELLOW 3"	CUFFIA SCARICO 3"	SOUFFLET ÉCHAPPEMENT 3"	1
20	REC70981A3	70981A3	FUELLE ESCAPE 3"	EXHAUST BELLOW 3"	CUFFIA SCARICO 3"	SOUFFLET ÉCHAPPEMENT 3"	1
21	REC98504A3	98504A3	CODO HIERRO 3" 15°	ELBOW (IRON CASTING) 3" 15°	GOMITO IN GHISA 3" 15°	COUDE FE 3" 15°	2
22	REC16-49545	16-49545	TORNILLO	STUD (STEEL)	VITE	VIS	1
23	REC27-33395	27-33395	JUNTA COLECTOR	GASKET EXHAUST MANIFOLD	GUARNIZIONE COLLETORE	JOINT COLLECTEUR	2
23	FEL17420	27-33395	KIT JUNTAS	GASKET EXHAUST MANIFOLD	KIT GUARNIZIONI	KIT JOINTS	2
24	REC22-384071	22-384071	TAPÓN	PLUG	TAPPO	BOUCHON	1
25	REC10-53728	10-53728	TORNILLO	SCREW	VITE	VIS	4
26	REC862210A01	22-862210A01	KIT TAPÓN Y CONDUCTO	HOSE FITTING WITH DRAIN PLUG KIT	KIT TAPPO	COUDE DRAIN POUR COLLECTEUR	1
27	RM807130A4	807130A4	CUERNOS DE ESCAPE	EXHAUST PIPE	CORNA DI SCARICO	CORNE D'ÉCHAPPEMENT	1
28	REC41802	41802	RETÉN TRANSOM	TRANSOM GASKET	GUARNIZIONE TRANSOM	JOINT TRANSOM	1
29	REC807166A1	807166A1	PALOMILLA ESCAPE	WATER SHUTTER	FARFALLA SCARICO	CLAPET ÉCHAPPEMENT	2
30	MAR246	860246A15	COLECTOR	MANIFOLD	COLLETORE	COLLECTEUR	2
31	HOT28503-MK		KIT MONTAJE PARA HOT20970	MOUNTING KIT HOT20970	KIT DI MONTAGGIO PER HOT20970	KIT DE MONTAGE POUR HOT20970	
32	RECK8503		KIT TORNILLOS CODO Y JUNTA	EXHAUST ELBOW MOUNTAING KIT	KIT VITI GOMITO	KIT VISSERIE POUR COUDE	
33	REC53400		KIT TORNILLOS CODO Y JUNTA	EXHAUST ELBOW MOUNTAING KIT	KIT VITI GOMITO	KIT VISSERIE POUR COUDE	
34	HOT20976-MK		KIT MONTAJE PARA MAR988	MOUNTING KIT MAR988	KIT DI MONTAGGIO PER MAR988	KIT DE MONTAGE POUR MAR988	
35	HOT27214-MK		KIT PARA MONTAJE PARA /1	MOUNTING KIT /1	KIT DI MONTAGGIO PER /1	KIT DE MONTAGE POUR /1	
36	HOT20985	93322A12AV	KIT RISER 152 mm	KIT RISER 6"	KIT RISER 6"	KIT HAUSSEUR 6"	
37	MAR3320PAR	93320A13	KIT RISER 76 mm	KIT RISER 3"	KIT RISER 3"	KIT HAUSSEUR 3"	
38	REC93320A15	93320A10	KIT RISER 76 mm	KIT RISER 3"	KIT RISER 3"	KIT HAUSSEUR 3"	

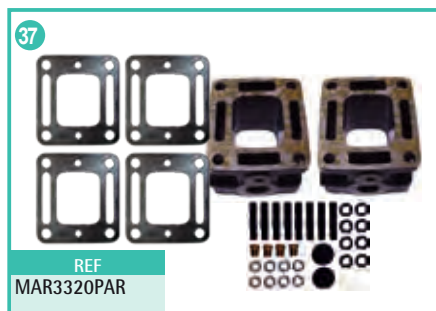

330, 340MIE, 370TRS, 454EFI, 454MAG, 7.4MIE, 7.4L, 7.4LX, GM454 CID V8  
502 EFI, 502 MAG, 8.2L, GM502 CID V8

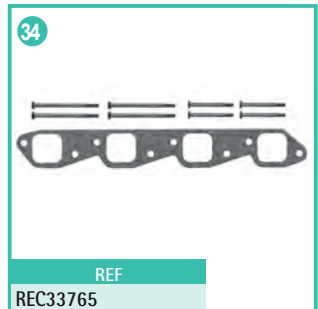
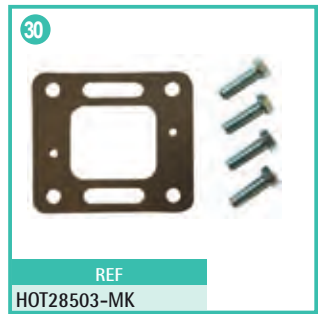
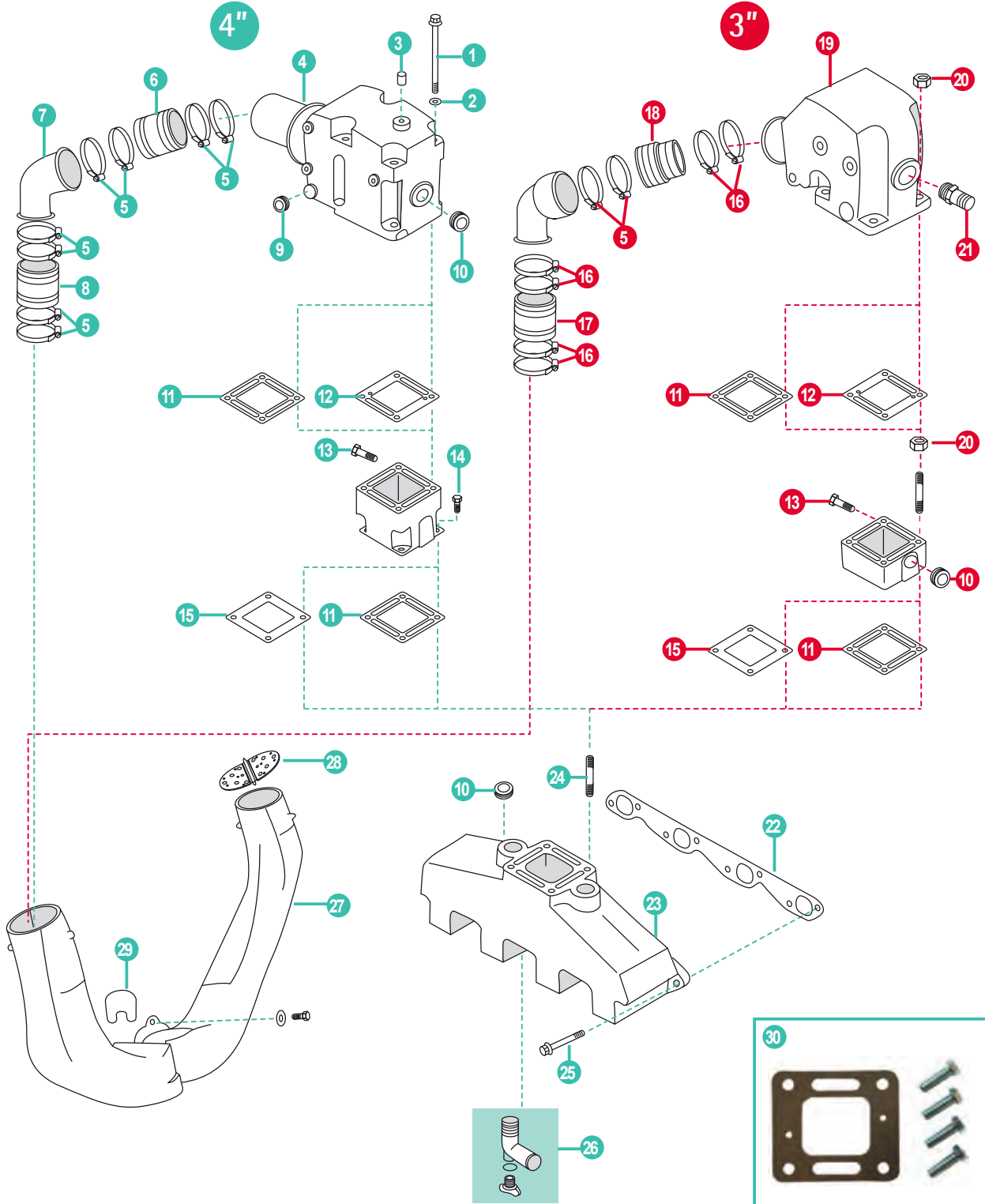

	REF	OEM					UN.
1	REC10-43749	10-43749	TORNILLO	SCREW STEEL ZINC PLATED	VITE	VIS	4
2	REC13-35048	13-35048	CIERRE	LOCKWASHER	CHIUSURA	RONDELLE	4
3	REC22-73379	22-73379	TAPÓN	PLUG	TAPPO	BOUCHON	1
4	MAR988	807988A03	CODO HIERRO 4" 7°	EXHAUST ELBOW (IRON CASTING) 4", 7°	GOMITO IN GHISA 4" 7°	COUDE FE 4" 7°	1
	SED3092600	807988A03	CODO INOX 4" 7°	EXHAUST ELBOW INOX, 4", 7°	GOMITO INOX 4" 7°	COUDE INOX 4" 7°	1
5	GS38322	54-815504372	ABRAZADERA	CLAMP	FASCETTA	COLLIER	10
6	REC32-44348001	32-44348001	FUELLE ESCAPE 4"	EXHAUST BELLOW 4"	CUFFIA SCARICO 4"	SOUFFLET ÉCHAPPEMENT 4"	1
7	BAMC-20-14478	14478T01	TUBO	TUBE	TUBO	TUYAU	1
8	REC32-14358001	32-14358001	FUELLE ESCAPE 4"	EXHAUST BELLOW 4"	CUFFIA SCARICO 4"	SOUFFLET ÉCHAPPEMENT 4"	1
9	REC22-36382	22-36382	TAPÓN	PLUG	TAPPO	BOUCHON	2
	REC22-41622	22-41622	TAPÓN ACERO	PLUG (STEEL)	TAPPO ACCIAIO	BOUCHON ACIER	2
10	REC22-428611	22-428611	TAPÓN BRONCE	PLUG (BRASS)	TAPPO IN BRONZO	BOUCHON BRONZE	2
11	REC27-863726	27-863726	JUNTA	GASKET EXHAUST MANIFOLD AND SPACERS	GUARNIZIONE	JOINT	1
12	REC27-863724Q	27-863724Q	JUNTA CODO ESCAPE	EXHAUST ELBOW GASKET	GUARNIZIONE GOMITO SCARICO	JOINT COUDE ÉCHAPPEMENT	1
13	REC22-328022	22-328022	TAPÓN	PLUG	TAPPO	BOUCHON	2
14	REC10-865982005	10-865982005	TORNILLO	SCREW	VITE	VIS	4
15	REC27-8637251	27-8637251	JUNTA COLECTOR CIRCUITO AGUA DULCE	MANIFOLD FRESH WATER COOLING	GUARNIZIONE COLLETTORE CIRCUITO CHIUSO	JOINT COLLECTEUR EAU FRAÎCHE	1
16	GS38320	54-815504256	ABRAZADERA	CLAMP	FASCETTA	COLLIER	6
17	REC32-90949T	32-90949T	FUELLE ESCAPE 3"	EXHAUST BELLOW 3"	CUFFIA SCARICO 3"	SOUFFLET ÉCHAPPEMENT 3"	1
18	REC70981A3	70981A3	FUELLE ESCAPE 3"	EXHAUST BELLOW 3"	CUFFIA SCARICO 3"	SOUFFLET ÉCHAPPEMENT 3"	1
19	REC98504A3	98504A3	CODO HIERRO 3" 15°	EXHAUST ELBOW (IRON CASTING) 3", 15°	GOMITO IN GHISA 3" 15°	COUDE FE 3" 15°	1
20	REC46335	46335	TUERCA	FLANGE SERRATED NUT	DADO	ÉCROU	4
21	REC22-866725	22-866725	RACORD COLECTOR	STRAIGHT FITTING	RACCORDO COLLETTORE	RACCORD COLLECTEUR	2
22	REC27-46820	27-46820	JUNTA COLECTOR	GASKET EXHAUST MANIFOLD	GUARNIZIONE COLLETTORE	JOINT COLLECTEUR	2
23	MAR078	807078T10	COLECTOR HIERRO	EXHAUST MANIFOLD ASSEMBLY (IRON )	COLLETTORE IN GHISA	COLLECTEUR FE	2
24	REC16-49545	16-49545	ESPÁRRAGO 3/8" x 13/4"	STUD 3/8" x 13/4"	PRIGIONIERO 3/8" x 13/4"	GOUJON 3/8" X 1/4"	4
25	REC10-37612	10-37612	TORNILLO	SCREW	VITE	VIS	8
26	REC862210A01	22-862210A01	KIT TAPÓN Y CONDUCTO	HOSE FITTING WITH DRAIN PLUG KIT	KIT RUBINETTO	COUDE DRAIN POUR COLLECTEUR	1
27	RM807130A4	807130A4	CUERNOS DE ESCAPE	EXHAUST PIPE	CORNA DI SCARICO	CORNE D'ÉCHAPPEMENT	1
28	REC807166A1	807166A1	PALOMILLA DE ESCAPE	WATER SHUTTER	FARFALLA SCARICO	CLAPET ÉCHAPPEMENT	2
29	REC41802	41802	RETÉN TRANSOM	TRANSOM GASKET	GUARNIZIONE TRANSOM	JOINT TRANSOM	1
30	HOT28503-MK		KIT MONTAJE PARA HOT20970	MOUNTING KIT HOT20970	KIT DI MONTAGGIO PER HOT20970	KIT DE MONTAGE POUR HOT20970	
31	RECK8503		KIT TORNILLOS CODO Y JUNTA	EXHAUST ELBOW MOUNTAING KIT	KIT VITI GOMITO	KIT VISSERIE POUR COUDE	
32	REC53400		KIT TORNILLOS CODO Y JUNTA	EXHAUST ELBOW MOUNTAING KIT	KIT VITI GOMITO	KIT VISSERIE POUR COUDE	
33	HOT20976-MK		KIT MONTAJE PARA MAR988	MOUNTING KIT MAR988	KIT DI MONTAGGIO PER MAR988	KIT DE MONTAGE POUR MAR988	
34	REC33765		KIT TORNILLOS COLECTOR Y JUNTA	EXHAUST MANIFOLD MOUNTING KIT	KIT VITI COLLETTORE	KIT VISSERIE POUR COLLECTEUR	
35	HOT20985	93322A12AV	KIT RISER 152 mm	KIT RISER 6"	KIT RISER 6"	KIT HAUSSEUR 6"	
36	MAR3320PAR	93320A13	KIT RISER 76 mm	KIT RISER 3"	KIT RISER 3"	KIT HAUSSEUR 3"	
37	HOT20957-MK		KIT MONTAJE MAR078	MOUNTING KIT ELBOW MAR078	KIT DI MONTAGGIO GOMITO MAR078	KIT DE MONTAGE POUR MAR078	

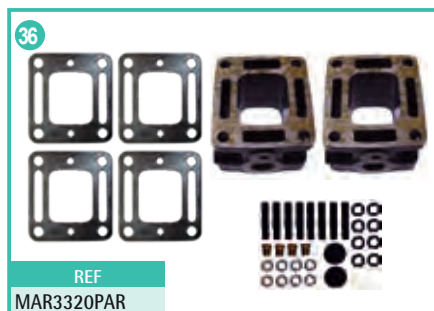

325-325MIE, GM427 CID V8  
 330-330MIE 370TRS - 400TRS - 440TRS - GM454 CID  
 390 - 390MIE - 460TRS, GM472 CID V8  
 225 - 225MIE - 250 - 250MIE - GM327CID - 228 - 228MIE  
 GM305CID - 250 - 270 - 270MIE - 280TRS - GM350 CID V8

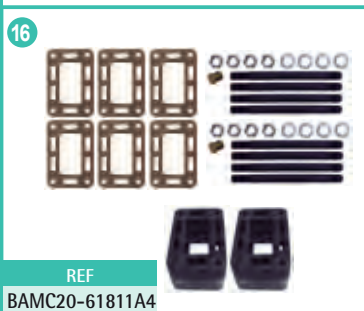
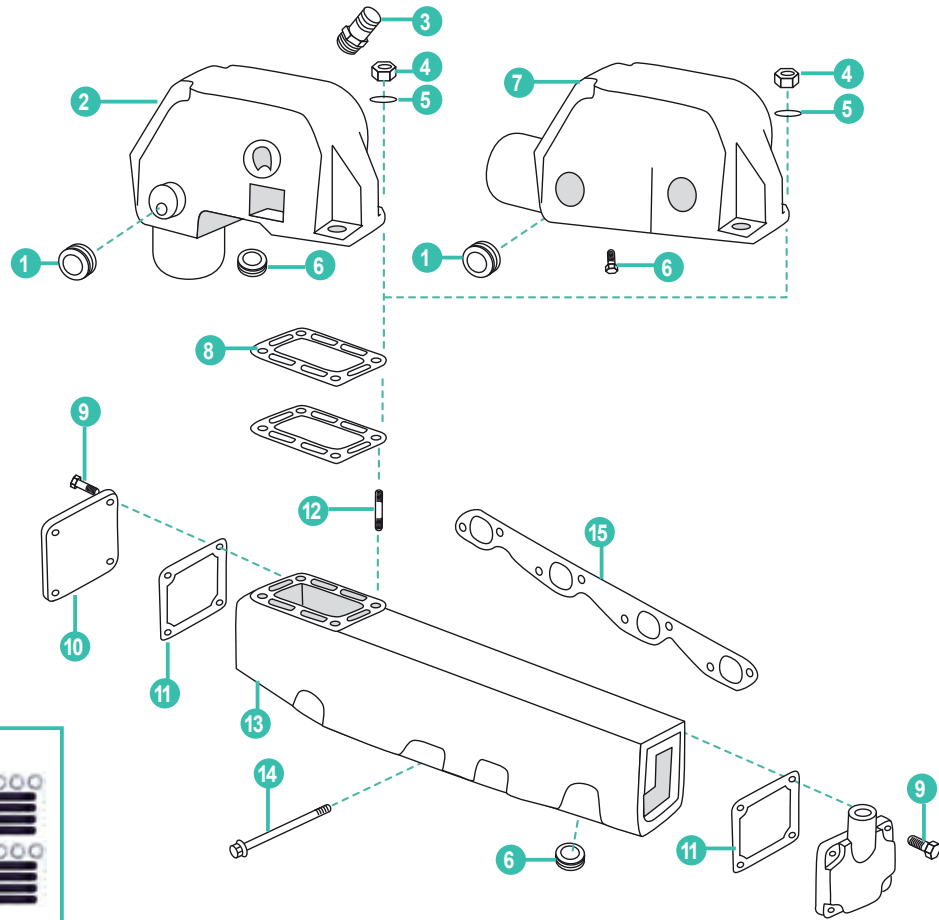

REF  
BAMC20-61811A4

	REF	OEM				
1	REC22-41622	22-41622	TAPÓN CODO	ELBOW PLUG	TAPPO SCARICO	BOUCHON COUDE
2	BAMC20-76668	76668A3	CODO ESCAPE	EXHAUST ELBOW	GOMITO SCARICO	COUDE ÉCHAPPEMENT
3	REC22-866725	22-866725	RACORD COLECTOR	STRAIGHT FITTING	TAPPO COLLETTORE	RACCORD COLLECTEUR
4	REC46335	11-46335	TUERCA CODO	NUT	DADO	ÉCROU
5	REC13-35048	13-35048	ARANDELA	WASHER	GUARNAIZIONE	RONDELLE
6	REC22-328022	22-328022	TAPÓN	CAP	TAPPO	BOUCHON
7	BAMC20-72963	72963A9	CODO ESCAPE	EXHAUST ELBOW	GOMITO SCARICO	COUDE ÉCHAPPEMENT
8	REC27-48042	27-48042	JUNTA	GASKET	GUARNIZIONE	JOINT
9	REC10-35386	10-35386	TORNILLO TAPA COLECTOR	SCREW MANIFOLD COVER	VITE COPERCHIO COLLETTORE	VIS COUVERCLE COLLECTEUR
10	HGE4870	73813A1	TAPA COLECTOR	MANIFOLD COVER	COPERCHIO COLLETTORE	COUVERCLE COLLECTEUR
11	REC27-480431	27-480431	JUNTA	GASKET	GUARNIZIONE	JOINT
12	REC16-49545	16-49545	TORNILLO CODO COLECTOR	STUD MANIFOLD	VITE GOMITO COLLETTORE	VIS COLLECTEUR
	BAMC1-47735	47735A17	COLECTOR BABOR	PORT MANIFOLD	COLLETTORE DI SINISTRA	COLLECTEUR BABORD
	BAMC1-47736	47736A17	COLECTOR ESTRIBORD	STBD MANIFOLD	COLLETTORE DI DESTRA	COLLECTEUR TRIBORD
13	BAMC1-47737	47737A1	COLECTOR BABOR (225 - 228 - 250 - 270 - 280 - 305 - 327 - 350)	PORT MANIFOLD (225 - 228 - 250 - 270 - 280 - 305 - 327 - 350)	COLLETTORE DI SINISTRA (225 - 228 - 250 - 270 - 280 - 305 - 327 - 350)	COLLECTEUR BABORD (225 - 228 - 250 - 270 - 280 - 305 - 327 - 350)
	BAMC1-47738	47738A1	COLECTOR ESTRIBORD (225 - 228 - 250 - 270 - 280 - 305 - 327 - 350)	STBD MANIFOLD (225 - 228 - 250 - 270 - 280 - 305 - 327 - 350)	COLLETTORE DI DESTRA (225 - 228 - 250 - 270 - 280 - 305 - 327 - 350)	COLLECTEUR TRIBORD (225 - 228 - 250 - 270 - 280 - 305 - 327 - 350)
14	REC10-37612	10-37612	TORNILLO 11/4"	SCREW 11/4"	VITE 11/4"	VIS 11/4"
	REC27-46820	27-46820	KIT JUNTAS COLECTOR	GASKET EXHAUST MANIFOLD	KIT GUARNIZIONI COLLETTORE	KIT JOINTS COLLECTEUR
15	REC27-33395	27-33395	KIT JUNTAS COLECTOR (225 - 228 - 250 - 270 - 280 - 305 - 327 - 350)	GASKET EXHAUST MANIFOLD (225 - 228 - 250 - 270 - 280 - 305 - 327 - 350)	KIT GUARNIZIONI COLLETTORE (225 - 228 - 250 - 270 - 280 - 305 - 327 - 350)	KIT JOINTS COLLECTEUR (225 - 228 - 250 - 270 - 280 - 305 - 327 - 350)
16	BAMC20-61811A4		KIT SUPLEMENTO CODO 76 mm	KIT RISER ELBOW 3"	KIT SUPPLEMENTO GOMITO 3"	KIT REHAUSSE 3"



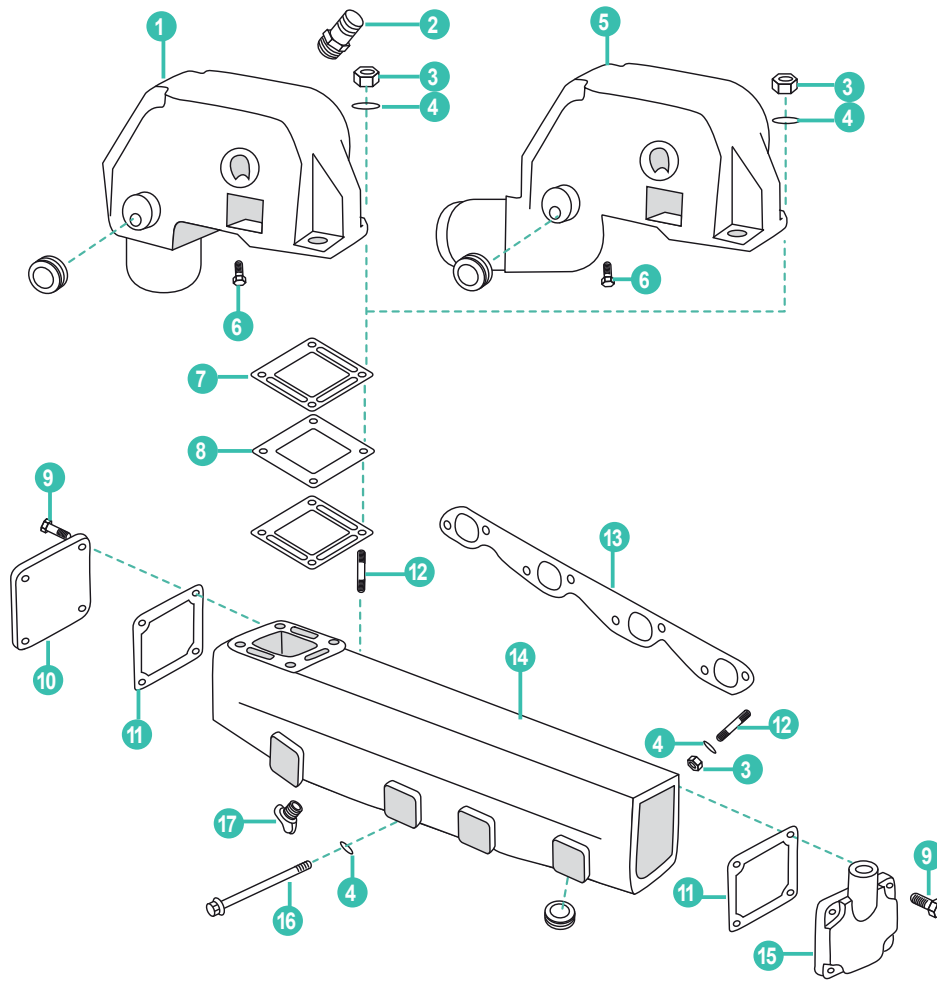

	REF	OEM				
1	HOT20971 HGE6351	76351A04	CODO ESCAPE	EXHAUST ELBOW	GOMITO DI SCARICO	COUDE D'ÉCHAPPEMENT
2	REC22-866725	27-866725	RACORD COLECTOR	STRAIGHT FITTING	RACCORD COLLETTORE	RACCORD COLLECTEUR
3	REC46335	11-46335	TUERCA CODO	NUT	DADO GOMITO	ÉCROU COUDE
4	REC13-35048	13-35048	ARANDELA	WASHER	RONDELLA	RONDELLE
5	HOT20978	76771A2	CODO ESCAPE	EXHAUST ELBOW	GOMITO DI SCARICO	COUDE D'ÉCHAPPEMENT
6	REC22-328022	22-328022	TAPÓN	CAP	TAPPO	BOUCHON
7	REC27-99777Q02	27-99777Q02	JUNTA	GASKET	GUARNIZIONE	JOINT
8	REC60207	60207	TAPA COLECTOR	MANIFOLD COVER	COPERCHIO COLLETTORE	COUVERCLE COLLECTEUR
9	REC10-35386	10-35386	TORNILLO TAPA COLECTOR	SCREW MANIFOLD COVER	VITE COPERCHIO COLLETTORE	VIS COUVERCLE COLLECTEUR
10	HGE4870	73813A1	TAPA COLECTOR	MANIFOLD COVER	COPERCHIO COLLETTORE	COUVERCLE COLLECTEUR
11	REC27-480431	27-40431	JUNTA	GASKET	GUARNIZIONE	JOINT
12	REC16-49545	16-49545	TORNILLO CODO COLECTOR	STUD MANIFOLD	VITE GOMITO COLLETTORE	VIS COUDE COLLECTEUR
13	REC3852455	27-73866	JUNTA COLECTOR ESCAPE	MANIFOLD GASKET	GUARNIZIONE COLLETTORE SCARICO	JOINT COLLECTEUR ÉCHAPPEMENT
14	HOT20962	65603A12	COLECTOR ESTRIBOR	STBD MANIFOLD	COLLETTORE DI DESTRA	COLLECTEUR TRIBORD
	HOT20958	65604A12	COLECTOR BABOR	PORT MANIFOLD	COLLETTORE DI SINISTRA	COLLECTEUR BABORD
15	REC60252A2	60252A2	TAPA COLECTOR	END CAP ASSY	COPERCHIO COLLETTORE	COUVERCLE COLLECTEUR
16	REC10-37612	10-37612	TORNILLO 11/4"	SCREW 11/4"	VITE 11/4"	VIS 11/4"
17	REC22-866725	27-866725	RACORD COLECTOR	STRAIGHT FITTING	RACCORD COLLETTORE	RACCORD COLLECTEUR
18	BAMC20-61851A3	KIT SUPLEMENTO 76 mm	KIT RISER ELBOW 3"	KIT RISER ELBOW 3"	KIT SUPPLEMENTO GOMITO 3"	KIT REHAUSSE 3"
19	HOT20560-MK	KIT MONTAJE PARA HOT20962/58	MOUNTING KIT ELBOW HOT20962/58	MOUNTING KIT ELBOW HOT20962/58	KIT MONTAGGIO GOMITO HOT20962/58	KIT DE MONTAGE POUR HOT20962/58
20	HOT26371-MK	KIT MONTAJE PARA HOT20978/71	MOUNTING KIT ELBOW HOT20978/71	MOUNTING KIT ELBOW HOT20978/71	KIT MONTAGGIO GOMITO HOT20978/71	KIT DE MONTAGE POUR HOT20978/71

COLECTORES

MANIFOLDS

COLLETTORE

COLLECTEURS

REF	OEM	
BAMC-1-63122	63122A10 63122A13 63122A14	120HP GM153

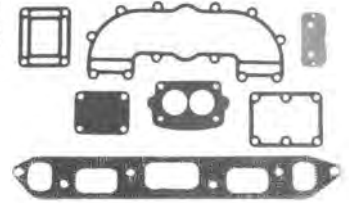

REF	OEM	
HOT20937	98562A6	3.7L Et 3.7LX 470, 485, 488 (1980-85) 160, 170, 180, 190 3.7L Et 3.7LX (1985-89)



HOT20937-MK



REF	OEM	
BAMC-1-95862	95862A5	Se adapta a la mayoría de: Fits most models Si adatta alla maggior parte dei Convient à la plupart des :  2.5L 153 CID 3.0L 181 CID carb. Rochester (1983-89)



REF	OEM	
REC96705A1	96705A1	Se adapta a la mayoría de: Fits most models Si adatta alla maggior parte dei Convient à la plupart des :  3.0L 181 CID carb. Rochester 2.5L, 153 CID (1968-82)



REF	OEM	
HOT20956	99798A18 806867A8 806235A04	Se adapta a la mayoría de: Fits most models Si adatta alla maggior parte dei Convient à la plupart des :  2.5L 153 CID 3.0L 181 CID carb. Mercab Et Electric Chore (1983-95)



HOT20956-MK

REF	OEM	
REC860235A03	860235A03	GM 181 (1990+)
	806867A3	3.0L OM680000+
	806867A12	3.0LX & 3.0TKS PLUS



REF	OEM	
BAMC-1-58759	58759A1	GM160 & GM165 (6 CYL)
	58759A10	
	58759A13	
	58759A14	



REF	OEM	
MAR746	99746A8	GM 4.3L & 3.8L V6 175, 185, 205, 229 & 262 (1985-02)
	99746A17	
	99746A3	



kit HOT20952



kit MAR746



REF	OEM	
MAR612	864612T01	GM4.3L MPI OM615000+ (2002+) 262



REF	OEM	
MAR735	865735A02	50L, 5.7L, 6.2L (V8) 305, 350, 377 (2002+)
	864308T01	
	865049T01	



kit MAR735





REF	OEM	
MAR246	860246A15	305, 350 Et 377 V8GM (1983-02)
	87114A19	
	860246A3	
	860246A9	
	860246A10	









REF	OEM	
MAR078	807078T10	GM V8 BIG BLOCK 330, 340, 370 (454) 7.4L 502 8.2L
	807078T09	
	807078A6	
	89011A8	



BABOR   PORT SINISTRA   BABORD	ESTRIBOR   STD DESTRA   TRIBORD		
REF	OEM	REF	OEM
HOT20950	77234A7	77235A8 77235A2	198, 228, 250, 255, 260, 898, 305CID (GM V8) Bloque pequeño con suplemento Small blocks with end riser Blocco piccolo con supplemento Bloque petit avec supplement
	77234A2		



BABOR   PORT SINISTRA   BABORD	ESTRIBOR   STD DESTRA   TRIBORD		
REF	OEM	REF	OEM
BAMC1-47735	47735A17	BAMC1-47736	47736A17 47736
	47735		
	47735A1		

BABOR   PORT SINISTRA   BABORD	ESTRIBOR   STD DESTRA   TRIBORD		
REF	OEM	REF	OEM
BAMC1-47737	47737A10	BAMC1-47738	47738A10 47738A1
	47737A1		

BABOR   PORT SINISTRA   BABORD	ESTRIBOR   STD DESTRA   TRIBORD		
REF	OEM	REF	OEM
HOT20958	65604A4	HOT20962	65603A3 65603A12
	65604A12		







**CODOS                      ELBOW                      GOMITI                      COUDE**

**CODO                      ELBOW                      GOMITO                      COUDE**

REF	OEM	
REC76325A2	76325A2	GM 2.5L Et 3.0L (1982-89) OLD MODEL (6 CYL INLINE)



REF	OEM	
MAR309	864309T02 864309T01	GM V6 Et V8 262, 305, 350, 377, 383 MPI (2002+) 7° (4" O.D. RISER)



**CODO BAJO  
LOW ELBOW  
GOMITO BASSO  
COUDE BASSE**

REF	OEM	
BAMC-20-55538	55538A2 39920	120 GM 153 (4 CYL) (1964-82) 160 GM 250 (6 CYL INLINE) (1967-69)

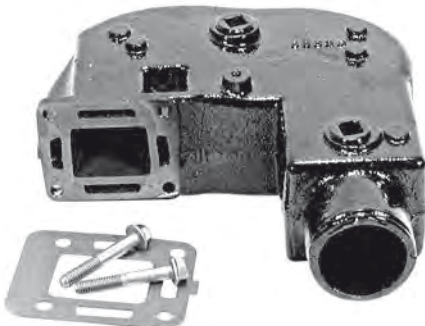

REF	OEM	
MAR591	864591T02	GM V6 Et V8 262, 305, 350, 377, 385, 6.2L MPI (2002+) 7° (4" O.D. RISER)



**CODO ALTO  
HIGH ELBOW  
GOMITO ALTO  
COUDE HAUTE**

REF	OEM	
MAR076	12076A2	GM 2.5L, 3.0 Et 3.0LX (1982+) NEW MODEL



REF	OEM	
BAMC20-76668	76668A3 76668A1 72964A1 47877A4	GM (454, 350, 305, 330 V8) 228, 250, 280, 288 Aplic: 3" O.D. RISER





REF	OEM	
MAR988	807988A03 807988A2 807914A1 44354A3	GM V6 Et V8 SMALL Et BIG BLOCK (1983-02) 7° (4" O.D. RISER)





REF	OEM	
REC76771A2	76771A2 76771A3	V8 GM Et FORD 470 (224/L4) GM (6 CYL INLINE) (-1983)



REF	OEM	
REC98504A3	98504A3	GM V6 Et V8 SMALL Et BIG BLOCK (1983+) 15° (3" O.D. RISER)



REF	OEM	
HOT20971	76351A04 76351A2 60426A1	MCM: 140, 470, 165 Et 200 (6 CYL INLINE) GM V8 305,350 FORD V8 302, 351 (-1982)



REF	OEM	
BAMC20-72963	72963A9 72963A1 76788A1 48101A1	GM V8 (454, 427, 482, 327, 350) 225, 250, 270, 325, 390, 330, 350, 370, 400, 440, 460 (1967-86) 3" O.D. RISER



**CODO ESCAPE PARA COLECTOR AL**      **EXHAUST ELBOW FOR MANIFOLD AL**      **GOMITO DI SCARICO PER COLLETTORE AL**      **COUDE ÉCHAPPEMENT POUR COLLECTEUR AL**

REF	OEM	
HOT20937	98562A6	165, 140, 180, 190 3.7L Et 3.7 LX (1985-89)



**CODO ESCAPE PARA COLECTOR HIERRO**      **EXHAUST ELBOW FOR MANIFOLD. IRON**      **GOMITO DI SCARICO PER COLLETTORE. GHISA**      **COUDE ÉCHAPPEMENT POUR COLLECTEUR FE**

REF	OEM	
HOT20905	90880A2	165, 170, 180, 190 3.7L Et 3.7 LX MCM (1980-89)





**CODO ESCAPE  
INOX 316**

**316 SS EXHAUST ELBOW**

REF	OEM	
SED3093300	805602A2	530DTA, 636, D183, D2.8L, D219, D254, D3.0L, D3.6L, D4.2L



**GOMITO DI SCARICO  
INOX 316**

**COUDE ÉCHAPPEMENT  
INOX 316**

REF	OEM	
SED3092000	805602A1	2.8L, D254, D3.6L, D4.2L



REF	OEM	
SED3093301	80176320	D183T, D219T, D530TA



**CODO ESCAPE  
INOX 316**

**316 SS EXHAUST ELBOW**

REF	OEM	
SED3092610	12076A2	4 CYL LATE MODELS



**GOMITO DI SCARICO  
INOX 316**

**COUDE ÉCHAPPEMENT**

REF	OEM	
SED3092600	807988A03	V6 & V-8 7" (4" O.D. RISER)



REF	OEM	
SED3095400	864309T02	GM V6 & V8 262, 305, 350, 377, 383 MPI (2002+) 4" O.D. RISER

**CODO BAJO  
LOW ELBOW  
GOMITO BASSO  
COUDE BASSE**



REF	OEM	
SED3095500	864591T02	GM V6 & V8 262, 305, 350, 377, 385, 6.2L MPI (2002+) 4" O.D. RISER

**CODO ALTO  
HIGH ELBOW  
GOMITO ALTO  
COUDE HAUTE**





**KIT RISER 3" / 76mm**

REF	OEM	COLECTORES MANIFOLDS COLLETTORI COLLECTEURS	
MAR3320PAR	93320A13 807476A6 93320A5	MAR746 MAR246 MAR078 (-2002)	305, 350, 262, 454, 502 (5.0, 5.7, 4.3, 7.4, 8.2) MCM V6 & TBI (2 colectores escape   2 exhaust manifold   2 collettore di scarico   2 collecteurs échappement ) (-OM614999) MCM/MIE/SKI V8 (305, 350, 377, 354 & 502 CID) (Codo de hierro   cast iron elbow   gomito in ghisa   coude) (-OM299999) MCM V8 (305 & 350 CID) Carb. (OM300000-OM599999) MIE & SKI Carb. (OM300000-OM316999)



REF	OEM	COLECTORES MANIFOLDS COLLETTORI COLLECTEURS	
REC93320A15	93320A15 93320A10	MAR746 MAR246 MAR078 (-2002)	MCM 4.3L MPI (OM3000000-OM614999) (2001-02) MCM V8 (305, 350, 377 CID) MPI (OM300000-OM599999) (2001-02) MIE & SKI V8 (350 & 377 CID) MPI (OM300000-OM316999) (2001-02) (sólo codos de hierro   Only with cast iron elbows   Solo gomiti in ghisa   seulement coudes en Fe)

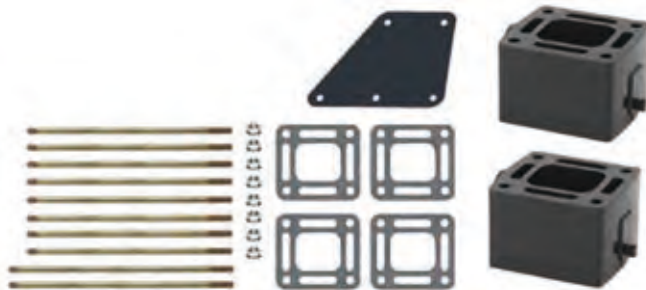

REF	OEM	COLECTORES MANIFOLDS COLLETTORI COLLECTEURS	
MAR929 HGE4929	864929A3	MAR612	350, 357, 377, 383, 385 (MAG, MPI) GM V6&V8 (4.3, 5.0, 5.7, 6.2) (2002+)



REF	OEM	COLECTORES MANIFOLDS COLLETTORI COLLECTEURS	
BAMC20-61811A4	61811A4 61811A3	BAMC1-47736 BAMC1-47737 BAMC1-47738 BAMC1-47735	GM V8 (427, 454 & 582 CID) 327, 305, 350 225, 250, 255, 270 & 280 (1977+) BASE RECTANGULAR RECTANGULAR BASE BASE RETTANGOLARE BASE RECTANGULAIRE

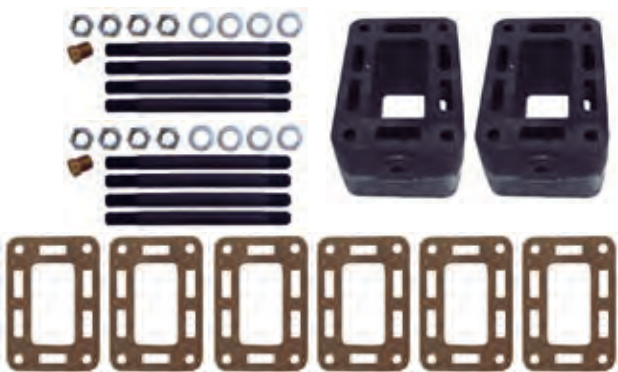

REF	OEM	COLECTORES MANIFOLDS COLLETTORI COLLECTEURS	
BAMC20-61851A3	61851A3	REC96705A1 HOT20956 BAMC-1-58759	140 HP (181 4cyl), 120 (2.5L), 153 GM 160, 165 (6 cyl inline)





## KIT RISER 6" / 152mm

REF	OEM	COLECTORES MANIFOLDS COLLETTORI COLLECTEURS	
HOT20985	93322A12	MAR746 MAR246 MAR078 (-2002)	MCM V6 & TBI (2 colectores   2 manifold   2 collettore   2 collecteurs ) (-OM614999) MCM/MIE/SKI V8 (305, 350, 377, 354 & 502 CID) (Fe) (-OM299999) MCM V8 (305 & 350 CID) Carb. (OM300000-OM599999) MIE & SKI Carb. (OM300000-OM316999)



REF	OEM	COLECTORES MANIFOLDS COLLETTORI COLLECTEURS	
BAMC-20-864908A1	864908A1	MAR612	350, 357, 377, 383, 385 (MAG, MPI) GM V6&V8 (4.3, 5.0, 5.7, 6.2) (2002+)

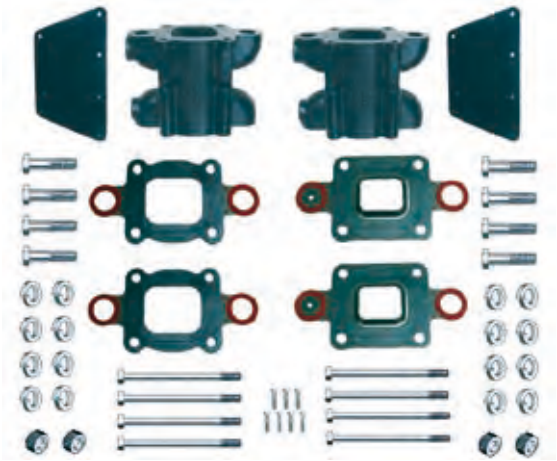

## TAPONES

## CAPS

## TAPPI

## BOUCHONS

REF	ROSCA
REC22-428611	3/4 - 14NPT
REC22-328022	1/8 - 27 NPT
REC22-32803	3/8 - 18 NPT
REC22-36382	1/4 - 18 NPT
REC22-41622	3/4 - 14 NPT
REC13980	
REC22-73379	.250-18



## EXTENSORES DE ESCAPE

## EXHAUST EXTENSIONS

## ESTENSIONI DI SCARICO

## PROLONGATEURS D'ÉCHAPPEMENT

REF	OEM	Ø	
BAMC-20-14478	14478T01 14478T	4"	175, 205, 229, 262 (V6) (1983-05) 200, 320, 305, 350, 377 (V8) (1993+) 330, 370, 454, 502 (V8 BIG BLOCK) (1981+)



REF	OEM	
RM14801A1	14801A1	5.0, 5.7, 6.2L V8 (1998+) INSTALAR EN MODELOS CON KITS DE RISER DE 3" & 6" INSTALL IN MODELS WITH 3" & 6" RISER KITS INSTALLARE NEI KIT DEI RISER DA 3" e 6" À INSTALLER SUR LES MODÈLES AVEC KITS DE 3" ET 6".



REF	OEM	
807130A4	"Y" PIPE V6 & V8, Alpha, Bravo	
RM807130A4	8M0115149 4.3, 5.0, 5.7, 6.2, 7.4, 8.2L GM	
44266T	4.5L MPI	
44266T1	7° 4" Codos   Elbows   Gomiti   Coudes	



TAPAS Y JUNTAS

CAPS & GASKETS

COPERCHI E GUARNIZIONE

COUVERCLES ET JOINTS

TAPA DE COLECTOR

END CAP MANIFOLD

COPERCHIO COLLETTORE

COUVERCLE COLLECTEUR

REF	OEM	COLECTORES MANIFOLDS COLLETTORI COLLECTEURS	
BA1-47638	47638A1	BAMC-1-63122	

REF	OEM	COLECTORES MANIFOLDS COLLETTORI COLLECTEURS	
REC60252A2	60252A2	REC96705A1 BAMC-1-58759 HOT20950 BAMC1-47735 BAMC1-47736 BAMC1-47737 BAMC1-47738 HOT20962 HOT20958	

REF	OEM	COLECTORES MANIFOLDS COLLETTORI COLLECTEURS	
HGE4870	73813A1	BAMC1-47735 BAMC1-47736 BAMC1-47737 BAMC1-47738 REC96705A1 BAMC-1-95862 HOT20956 BAMC-1-58759	

REF	OEM	COLECTORES MANIFOLDS COLLETTORI COLLECTEURS	
REC805629A1	805629A1	BAMC-1-95862 HOT20956	

JUNTAS TAPAS LATERALES SIDE GASKET CAPS

GUARNIZIONE COPERCHIO LATERALE

JOINTS COUVERCLE LATERAL

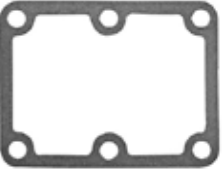
REF	OEM	TAPAS CAPS COPERCHIO COUVERCLE	
REC27-39917	27-39917	BA1-47638	

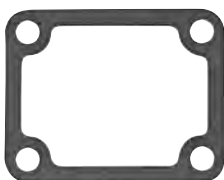
REF	OEM	TAPAS CAPS COPERCHIO COUVERCLE	
BAMC47-27-39923	27-39923	39916	

REF	OEM	TAPAS CAPS COPERCHIO COUVERCLE	
REC27-807218	27-807218	HGE4870 REC805629A1	

REF	OEM	TAPAS CAPS COPERCHIO COUVERCLE	
REC27-480431	27-480431	REC60252A2	

**JUNTAS TAPA POSTERIOR  
INTERCAMBIADOR**

**HEAT EXCHANGER END  
CAP**

**COPERCHIO POSTERIORE  
SCAMBIATORE**

**JOINTS DU COUVERCLE  
ARRIERE DE L'ECHANGEUR**

REF	OEM	
REC27-99960	27-99960	224 CID (1976-89)



**JUNTAS COLECTOR-CODO**

**MANIFOLD-ELBOW  
GASKET**

**GUARNIZIONE  
COLLETTORE-GOMITO**

**JOINTS  
COLLECTEUR - COUDE**

REF	OEM	CODOS ELBOWS GOMITI COUDES
REC27-39915	27-39915	BAMC-20-55538

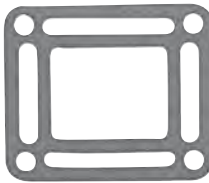

REF	OEM	CODOS ELBOWS GOMITI COUDES
REC27-99777Q02	27-99777Q02	HOT20971
	27-997771	REC76771A2
	27-997772	MAR076
		REC76325A2

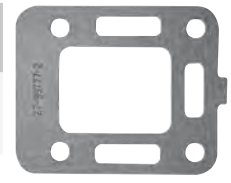

REF	OEM	CODOS ELBOWS GOMITI COUDES
REC27-18272	27-18272	HOT20937 AL



REF	OEM	CODOS ELBOWS GOMITI COUDES
REC27-856705	27-856705	HOT20905
	27-97542	FE



REF	OEM	CODOS ELBOWS GOMITI COUDES
REC27-8637251	27-8637251	MAR988
	860231	REC98504A3
	863725	



REF	OEM	CODOS ELBOWS GOMITI COUDES
REC27-48042	27-48042	BAMC20-76668
		BAMC20-72963



REF	OEM	CODOS ELBOWS GOMITI COUDES
REC27-863724Q	27-863724Q	MAR988
	27-41813	REC98504A3
	27-860233	
	27-863724	



REF	OEM	CODOS ELBOWS GOMITI COUDES
REC270	27-864547A02	MAR309
	27-864550A02	MAR591
	27-864549A02	



REF	OEM	CODOS ELBOWS GOMITI COUDES
REC27-863726	27-863726	MAR988
	27-871051	REC98504A3
	27-818832	
	27-860232	



REF	OEM	CODOS ELBOWS GOMITI COUDES
REC8M2004414	8M2004414	STANDARD COOLING V6 Et V8 NEW MODELS



new

**new**

REF	OEM
RM27-864549A02	27-864549A02

**1 CLOSED COOLING**



**new**

REF	OEM
REC27-864547A02	27-864547A02

**2 OPEN COOLING**



**new**

REF	OEM
REC27-864850A02	27-864850A02

**3 RESTRICTOR COOLING**

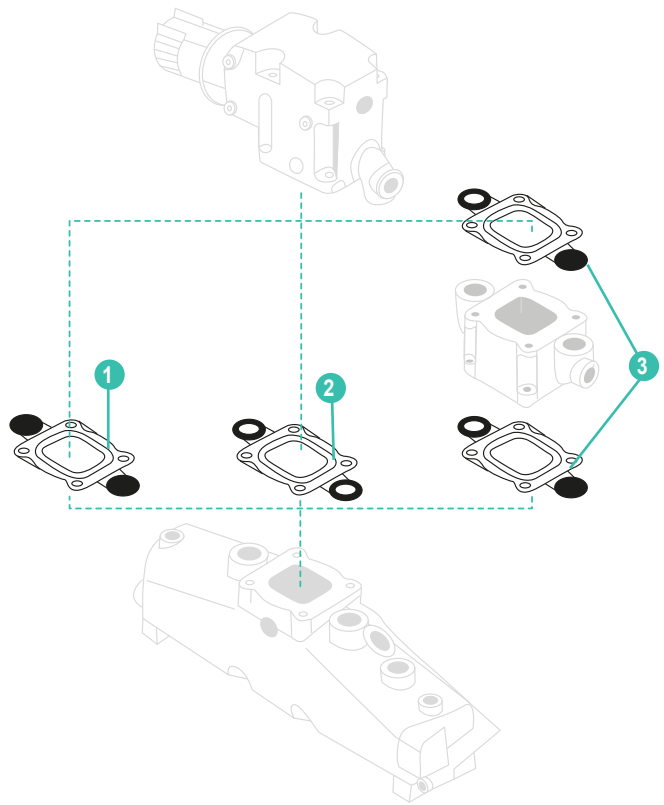
**JUNTAS COLECTOR-CULATA**      **MANIFOLD-HEAD GASKET**

REF	OEM	COLECTORES MANIFOLDS COLLETTORI COLLECTEURS	Image
REC27-68715	27-68715	MCM 3.7L (4 cyl)	

REF	OEM	COLECTORES MANIFOLDS COLLETTORI COLLECTEURS	Image
REC27-52546	27-52546	BAMC-1-63122	GM 153 (4 cyl)



REF	OEM	COLECTORES MANIFOLDS COLLETTORI COLLECTEURS	Image
REC27-53354	27-53354	REC96705A1	GM 181 (4 cyl)



**GUARNIZIONE COLLETTORE-TESTATA**      **JOINTS COLLECTEUR-CULASSE**

REF	OEM	COLECTORES MANIFOLDS COLLETTORI COLLECTEURS	Image
REC27-815528	27-815528	REC860235A03	GM 181 (4 cyl)



REF	OEM	COLECTORES MANIFOLDS COLLETTORI COLLECTEURS	Image
FEL17319	27-46401	BAMC-1-58759	GM 250 (6 cyl Inline)



REF	OEM	COLECTORES MANIFOLDS COLLETTORI COLLECTEURS	Image
REC27-99757	27-99757	MAR746 MAR612	GM V6 1





REF	OEM	COLECTORES MANIFOLDS COLLETTORI COLLECTEURS	
REC27-96429	27-96429	BAMC-1-95862 HOT20956	GM 153 & 181 (4 cyl)





REF	OEM	COLECTORES MANIFOLDS COLLETTORI COLLECTEURS		
REC27-33395	27-33395	HOT20950	GM V8 SMALL BLOCK	1
FEL17420		MAR246		2



REF	OEM	COLECTORES MANIFOLDS COLLETTORI COLLECTEURS		
REC27-46820	27-46820	MAR078 BAMC1-47735 BAMC1-47736	GM V8 BIG BLOCK	1



REF	OEM	COLECTORES MANIFOLDS COLLETTORI COLLECTEURS		
REC3852455	27-73866	HOT20958	FORD V8 (302, 351)	1
FEL17460		HOT20962		2



### FUELLES DE ESCAPE

### EXHAUST BELLOW

REF	OEM	
REC53114A1	53114A1	120, 140, 160, 165 (GM 181 & 250)
CEF500524	53114	(1967-82)



REF	OEM	Ø IN.
REC70981A3	70981A3	3" - 4" (76 - 101 mm)
CEF500523		



REF	OEM	Ø IN.
REC32-90949T	32-90949T	3" (76 mm)
CEF500511K		



### CUFFIA DI SCARICO

### SOUFFLET D'ÉCHAPPEMENT

REF	OEM	Ø IN.
REC32-44348001	32-44348001	4" (101 mm)
CEF500507K	32-44348T	Tubo superior Upper tubo
	32-44348	Tubo superiore Tube supérieure



REF	OEM	Ø IN.
REC32-14358001	32-14358001	4" (101 mm)
CEF500508K	32-14358T	Tubo inferior Lower tubo
	32-14358	Tubo inferiore Tube inférieure



REF	OEM	Ø IN.	
REC32-807458T	32-807458T	4" (101 mm)	4.3L (1996+)
CEF500532K			



### PALOMILLAS DE ESCAPE

### WATER SHUTTER

REF	OEM	Ø	
REC99370A2	99370A2	3" (76 mm)	V6-V8 (1982-87)





REF	OEM	Ø	
REC807166A1	807166A1	4" (101 mm)	V6-V8 (1992+) 4.5L MPI



### FARFALLA DI SCARICO

### CLAPET D'ÉCHAPPEMENT

REF	OEM	Ø		
REC807166A3	807166A3	4" (101 mm)	V6-V8 (1992-95)	2
14348A1			D3.0, D3.6, D4.2L	



REF	OEM	
REC60930	60930	4 cyl 140 / 3.0L / 3.0LX V8 TDI 4.2L (335, 370 MCM/MIE)



PROTECTORES SALIDA DE ESCAPE

EXHAUST PROTECTOR VALVES

PROTEZIONE SCARICO

PROTECTEURS DE SORTIE D'ÉCHAPPEMENT

REF	OEM	
REC34765A2	34765A2	76 mm = 3"
REC12644A1	12644A1	101 mm = 4"
REC89260		127 mm = 5" 152 mm = 6"



REC34765A2



REC12644A1



REC89260

COLECTOR ADMISIÓN

INTAKE MANIFOLD

COLLETTORE ASPIRAZIONE



COLLECTEURS ADMISSION

TAPA DE COLECTOR



END CAP MANIFOLD

COPERCHIO COLLETTORE



COUVERCLE COLLECTEUR

REF	OEM			
MP425036	824330 824330T	8	GM 262, 4.3 (V6) VORTEC (4 bbl) FE (1993+)	REC824326002





REF	OEM			
MP425113	811575 811575T 59974	16	GM V8 BIG BLOCK 427 & 454 (1969-97) GEN IV, V, VI (4 bbl)	REC17340



REF	OEM			
MP425024	824324T 824324	8	GM 262, 4.3 (V6) VORTEC (2 bbl) FE (1993+)	REC824326002



REF	OEM			
MP425149	72608 72608T	16	GM 454, 482, 502 (1978-97)	REC17341



REF	OEM			
REC425062	807289A1	8	M V8 (350, 5.7) VORTEC (4 bbl) (1993+)	REC27-807473A1



# UNIDADES DE TRANSMISIÓN TRANSMISSION UNIT

# UNITÀ DI TRASMISSIONE EMBASES ET PIÈCES

## BRAVO I, II, III

### PARTE SUPERIOR

### DRIVE SHAFT HOUSING

### PARTE SUPERIORE

### PARTIE SUPÉRIEURE

OEM	2	REDUCCIÓN RATIO RIDUZIONE REDUCTION	SERIAL
1589-865440H52	REC1589-865440H52	BRAVO 1 1.65 BRAVO 2 2.20 BRAVO 3 2.20 & 2.43	30/23
1589-865440H51	REC1589-865440H51	BRAVO 1 1.50 BRAVO 2 1.65 & 2.00 BRAVO 3 1.5, 1.65 & 2.00	32/27 0W250000 +
1589-865440H50	REC1589-865440H50	BRAVO 1 1.36 BRAVO 2 1.81 BRAVO 3 1.36 & 1.81	29/27



### PARTE INFERIOR

### COMPLETE GEAR HOUSING ASSEMBLY

### PARTE INFERIORE

### PARTIE INFÉRIEURE

OEM	1	REDUCCIÓN RATIO RIDUZIONE REDUCTION	ENTRADAS DE AGUA WATER INTAKE PRESA D'ACQUA INLETS D'EAU	SERIAL
BRAVO I	1656-8866A55 1656-8866A63	REC1656-8866A55 REC1656-8866A63	ALL ALL	1 2
BRAVO III	1656-8M0046733 1656-8M0046735 1656-8M0046738 1656-8M0046682	REC1656-8M0046733 REC1656-8M0046735 REC1656-8M0046738 REC1656-8M0046682	1.36 & 1.5 1.65 1.81, 2.00 & 2.20 2.43	OD784124+ & X OD784124+ & X, XR 0W240000+ 0W240000+ OD784124+ & X



### COLA COMPLETA

### COMPLETE DRIVE SHAFT

### PIEDE COMPLETO

### EMBASE COMPLÉT

OEM	REDUCCIÓN RATIO RIDUZIONE REDUCTION	ENTRADAS DE AGUA WATER INTAKE PRESA D'ACQUA INLETS D'EAU	SERIAL
BRAVO I	5-5231100NP REC1589-865440H50 REC1656-8866A55	1.36	1 0M0100001 - 0W249999
	5-5231200NP REC1589-865440H51 REC1656-8866A55	1.50	1 0M0100001 - 0W249999
	5-5231300NP REC1589-865440H50 REC1656-8866A55	1.65	1 0M0100001 - 0W249999
	5-5231100TP REC1589-865440H50 REC1656-8866A63	1.36	2 0W250000 +
	5-5231200TP REC1589-865440H51 REC1656-8866A63	1.50	2 0W250000 +
	5-5121300TP REC1589-865440H52 REC1656-8866A63	1.65	2 0W250000 +
BRAVO III	5-5441100TP REC1589-865440H50 REC1656-8M0046733	1.36	0W250000 +
	5-5441200TP REC1589-865440H51 REC1656-8M0046733	1.50	0W250000 +
	5-5441300TP REC1589-865440H51 REC1656-8M0046735	1.65	0W250000 +
	5-5441400TP REC1589-865440H50 REC1656-8M0046738	1.81	0W250000 +
	5-5441600TP REC1589-865440H51 REC1656-8M0046738	2.0	0W250000 +
	5-5441500TP REC1589-865440H52 REC1656-8M0046738	2.20	0W250000 +
	5-5441700TP REC1589-865440H52 REC1656-8M0046682	2.43	0W250000 +



# R / MR / ALPHA ONE

## COLA COMPLETA

## COMPLETE DRIVE SHAFT

## PIEDE COMPLETO

## EMBASE COMPLÉT

STD ROT. (13/21 THEETH 1972-92)		CONTRAROTACIÓN COUNTER ROTATION CONTRO-ROTAZIONE CONTRE-ROTATION		REDUCCIÓN RATIO RIDUZIONE REDUCTION	
OEM	1	OEM	1	2	
5-5010147CP	REC1623-8951A43	5-5000147CP	REC1623-8951A33	REC1547-9412A20	1.47, 1.50 (20/22) V8 (-300HP)
5-5010162CP		5-5000162CP		REC1547-9412A21	1.62, 1.65 (24/24) 6 Cyl in-line
5-5010181CP		5-5000181CP		REC1547-9412A22	1.81, 1.84 (17/19) V6 Et 470/485
5-5010194CP		5-5000194CP		REC1547-9412A23	1.94, 1.98 (20/24) 4 Cyl in-line

Se suministra en dos piezas sin tornillos de unión ni ánodos. Para una instalación completa pida las siguientes referencias:

Supplied in 2 pieces without union screws nor anodes. For a complete installation ask for the following references:

Fornito in due pezzi senza viti di unione e senza anodi. Per un'installazione completa richiedere i seguenti riferimenti:

Livré en deux pièces sans vis de connexion et sans anodes. Pour une installation complète, veuillez demander les références suivantes :

REF					UN.
REC10-30206	TORNILLO	SCREW	VITE	VIS	1
REC11-34933	TUERCA	NUT	DADO	ÉCROU	5
CMALPHAGEN1KITA	KIT ANODOS	ANODES KIT	KIT ANODI	KIT ANODES	1



## PARTE SUPERIOR COMPLETA

## COMPLETE DRIVE SHAFT HOUSING

## PARTE SUPERIORE COMPLETO

## PARTIE SUPÉRIEURE COMPLETE

2	OEM	REDUCCIÓN RATIO RIDUZIONE REDUCTION	
REC1547-9412A20	1547-9412A20	1.47, 1.50 (20/22)	V8 (-300 HP) 9-9/16" new style input yoke 6 Cyl inline
REC1547-9412A21	1547-9412A21	1.62, 1.65 (24/24)	9-9/16" new style input yoke V6 Et 470/485
REC1547-9412A22	1547-9412A22	1.81, 1.84 (17/19)	9-9/16" new style input yoke 4 Cyl inline
REC1547-9412A23	1547-9412A23	1.94, 1.98 (20/24)	9-9/16" new style input yoke





# MC1 / R / MR / ALPHA ONE

## PARTE INFERIOR COMPLETA

## COMPLETE GEAR HOUSING ASSEMBLY

## PARTE INFERIORE COMPLETA

## PARTIE INFÉRIEURE COMPLETE

STD		CR		ESTRÍAS EJE SPLINE DRIVE SHAFT SCALANATURE ASSE SPLINES D'ARBRE	
OEM	1	OEM	1		
1623-8951A43	REC1623-8951A43	1623-8951A33	REC1623-8951A33	13	6225577+ (1972-92)

CARCASA PARTE INFERIOR (Sin componentes)  
GEAR HOUSING (Without components)  
CARCASSA PARTE INFERIORE (Senza componenti)  
BOÎTIER PARTIE INFÉRIEURE (sans les composants)

REF	OEM	
REC1623-5356A4	1623-5356A4	1 Et R
REC1623-8951A37	1623-8951A37	Alpha One Et MR

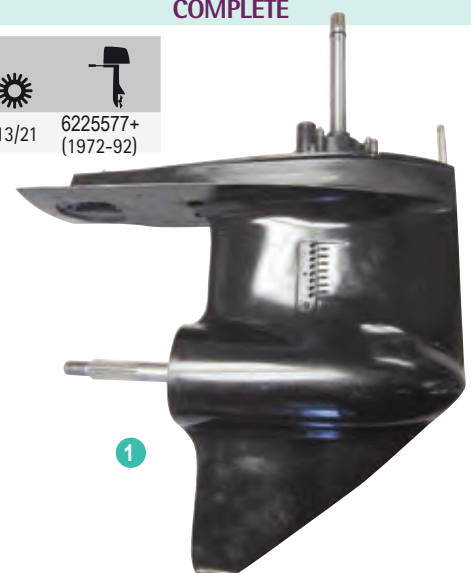



# ALPHA ONE GEN II

## COLA COMPLETA

## COMPLETE DRIVE SHAFT

## PIEDE COMPLETO

## EMBASE COMPLET

STD ROT. (13/21 THEETH 1972-92)	CONTRAROTACIÓN COUNTER ROTATION CONTRO-ROTAZIONE CONTRE-ROTATION	REDUCCIÓN RATIO RIDUZIONE RÉDUCTION	
OEM 1	OEM 1	2	
5-5121200TP	5-5111200TP	REC1547-861063A12	1.47 (20/22) 5.0L EFI
5-5121300TP	5-5111300TP	REC1547-861063A10	1.62 (24/24) 5.7   350 MAG (MPI) -300HP
5-5121400TP	5-5111400TP	REC1547-861063A8	1.81 (17/19) 4.3 LH / 4.3L EFI / 5.0L (MPI)
5-5121500TP	5-5111500TP	REC1547-861063A6	1.81 (17/19) 4.3L / 4.3LX (MPI)
			1.94 (20/24) 3.0L / 3.0LX (MPI)

Se suministra en dos piezas sin tornillos de unión ni ánodos. Para una instalación completa pida las siguientes referencias:

Supplied in 2 pieces without union screws nor anodes. For a complete installation ask for the following references:

Fornito in due pezzi senza viti di unione e senza anodi. Per un'installazione completa richiedete i seguenti riferimenti:

Livré en deux pièces sans vis de connexion et sans anodes. Pour une installation complète, veuillez demander les références suivantes :

REF	UN.
REC10-816601 TORNILLO SCREW VITE VIS	4
REC11-859135 TUERCA NUT DADO ÉCROU	4
REC12-45176 ARANDELA WASHER RONDELLA RONDELLE	4
REC23-816583 TUBO AGUA WATER TUBE TUBO ACQUA TUYAU D'EAU	1
CMALPHAKITA KIT ANODOS ANODES KIT KIT ANODI KIT ANODES	1

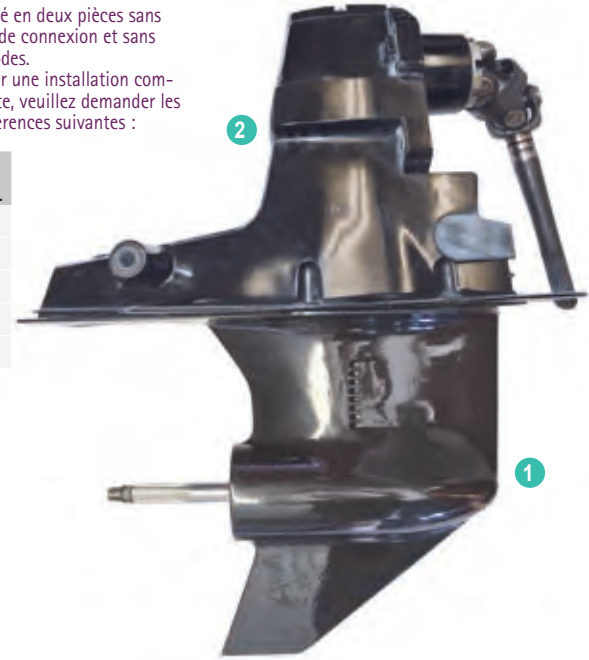

## PARTE SUPERIOR COMPLETA

## COMPLETE DRIVE SHAFT HOUSING

## PARTE SUPERIORE COMPLETO

## PARTIE SUPÉRIEURE COMPLETE

2	OEM	REDUCCIÓN RATIO RIDUZIONE RÉDUCTION	
REC1547-861063A12	1547-861063A12	1.47 (20/22)	5.0L EFI / 5.7 / 350 MAG
REC1547-861063A10	1547-861063A10	1.62 (24/24)	4.3LH / 4.3L EFI / 5.0L
REC1547-861063A8	1547-861063A8	1.81 (17/19)	4.3L / 4.3LX
REC1547-861063A6	1547-861063A6	1.94 (20/24)	3.0L / 3.0LX

CARCASA PARTE SUPERIOR (Sin componentes)  
DRIVE SHAFT HOUSING (Without components)  
CARCASSA PARTE SUPERIORE (Senza componenti)  
BOÎTIER PARTIE SUPÉRIEURE (sans les composants)

REF	OEM	
REC1547-815930A7	1547-815930A7	OD469859-OK999999, (1991-97)

## PARTE INFERIOR COMPLETA

## COMPLETE GEAR HOUSING ASSEMBLY

## PARTE INFERIORE COMPLETA

## PARTIE INFÉRIEURE COMPLETE

STD	CR	REDUCCIÓN RATIO RIDUZIONE RÉDUCTION	
OEM 1	OEM 1		
1623-815822A53 1623-815822A43 1623-815823A5 1623-815822A32 1623-815822A45 623-815822A55	1623-815822A47 REC1623-815822A47	2.00, 2.40	OD469859+
		2.00, 2.40 (14/28 dientes   teeth   denti   dents)	OL100040+ (1998+)

CARCASA PARTE INFERIOR (Sin componentes)  
GEAR HOUSING (Without components)  
CARCASSA PARTE INFERIORE (Senza componenti)  
BOÎTIER PARTIE INFÉRIEURE (sans les composants)

REF	OEM	
REC1623-815822A30	1623-815822A30 1623-815822A6	OD469859-OK999999 3.50" OD FWD bearing

R / MR / ALPHA ONE  
(6225577 - OD469858)

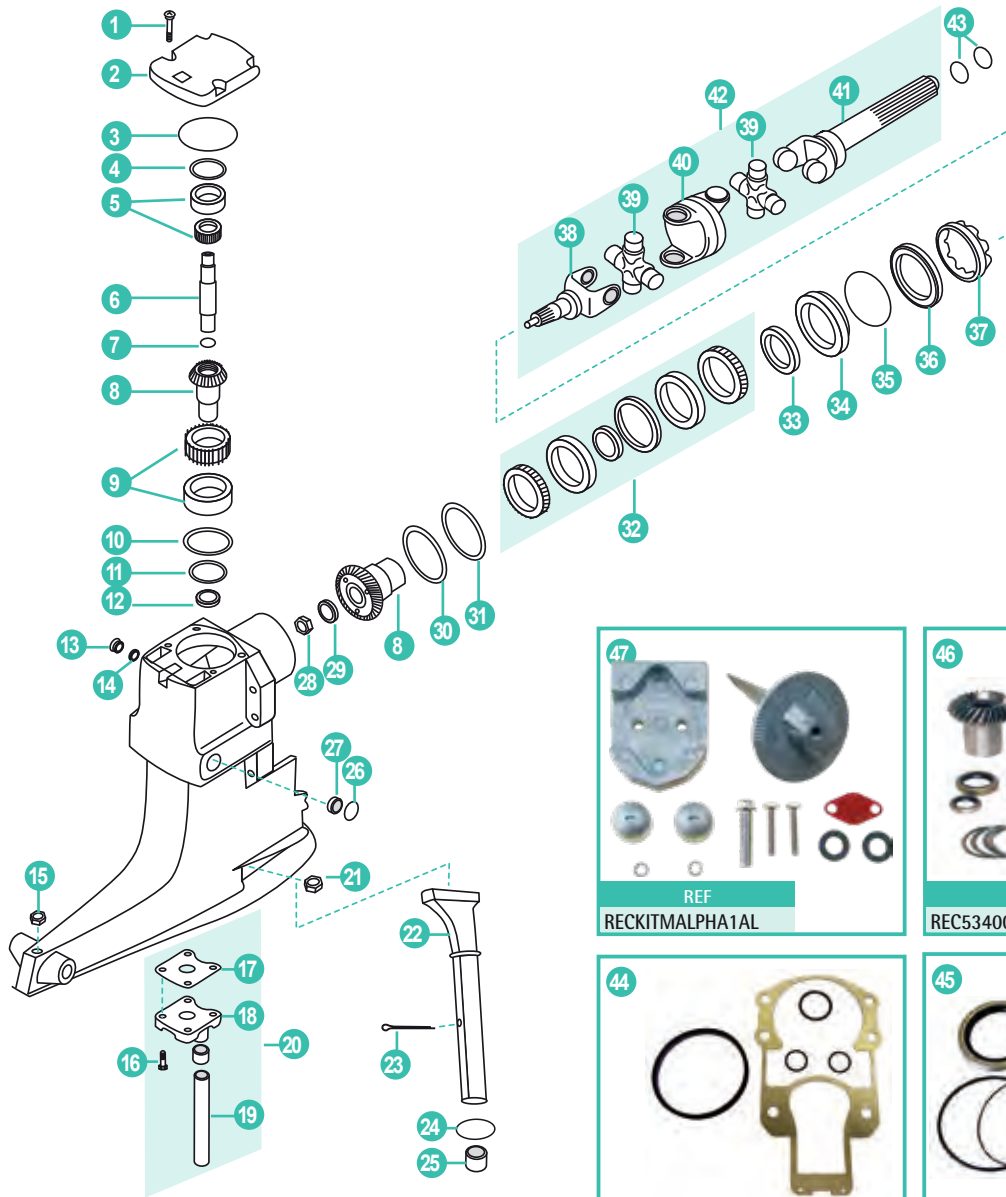

Abrazadera U de acoplamiento (39385A1) en modelos en línea.

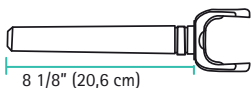

U-joint coupling end yoke (39385A1) used on older in-line models.

Il giogo terminale di giunzione a giunto U (39385A1) ha utilizzato i modelli on-line in linea.

Pince en U de couplage (39385A1) sur les modèles en ligne.

USO DE MODELOS ANTIGUOS DE COLAS EN MODELOS MERCURUISER IR-IMR

Mercury Marine no recomienda el uso de colas de modelos antiguos en modelos IR-IMR, ya que estas unidades no se acoplarán satisfactoriamente con el ensamblaje del transmisor. Además, las unidades en serie del modelo anterior, están equipadas con una horquilla de acoplamiento de unión en U (39385A1). Este eje es más corto que el (59830A1) usado en las unidades de impulsión de popa IR-IMR, y por lo tanto no acoplará completamente las estrías del motor. El uso del modelo más antiguo en un modelo de IR-IMR llevará al fallo de spline para acoplar al eje.

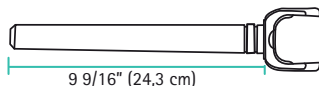

USE OF OLDER MODEL STERN DRIVE UNITS ON MERCURUISER IR-IMR MODELS

Mercury Marine does not recommend the use of older model stern drive units on IR-IMR models, as these units will not mate up satisfactorily with the transmisor assembly. In addition, the older model in-line stern drive units are equipped with U-joint coupling end yoke (39385A1). This yoke is shorter than yoke (59830A1) used on the IR-IMR stern drive units, and therefore will not fully engage the engine coupler splines. Use of an older in-line model stern drive unit on a IR-IMR model will result in a spline failure to coupling an/or yoke.

UTILIZZO DI MODELLI OLDER PIEDE SUI MODELLI IR-IMR MERCURUISER

Mercury Marine non ha raccomandato l'uso di unità di trasmissione a poppa più vecchie sui modelli IR-IMR, in quanto queste unità non si addicono in modo soddisfacente con l'assemblaggio del frangolo. In aggiunta, le unità di comando a poppa in linea in versione anteriore sono dotate di giogo terminale di giunzione a U (39385A1). Questo giogo è più corto del giogo (59830A1) usato sulle unità di azionamento a poppa IR-IMR e pertanto non impegnerà completamente le spline di accoppiatore del motore. L'uso di un'unità anteriore di tipo a poppa modello in linea su un modello IR-IMR provocherà un errore di spline per accoppiare un / o giogo.

UTILISATION DES QUEUES DE MODELES PLUS ANCIENS SUR LES MODELES MERCURUISER IR-IMR

Mercury Marine ne recommande pas l'utilisation d'anciens modèles de queues sur les modèles IR-IMR, car ces unités ne s'accoupleront pas de manière satisfaisante avec l'assemblage du tableau arrière. En outre, les unités de l'ancienne série sont équipées d'une fourche d'accouplement en U (39385A1). Cet arbre est plus court que le (59830A1) utilisé dans les unités d'entraînement arrière IR-IMR, et ne s'engage donc pas complètement dans les cannelures du moteur. L'utilisation de l'ancien modèle dans un modèle IR-IMR entraînera l'échec de l'accouplement des cannelures à l'arbre.

	REF	OEM				
1	REC10-98794	10-98794	TORNILLOS TAPA 3/8-16	SCREW 3/8-16	VITE 3/8-16	VIS 3/8-16
2	REC94998A4	94998A4	TAPA CON COJINETE	COVER ASSEMBLY	COPERCHIO CON CUSCINETTO	COUVERCLE AVEC ROULEMNT
3	REC25-32546	25-32546	ARO TÓRICO	O-RING	O-RING	JOINT TORIQUE
4	REC15-45691A1	15-45691A1	SUPLEMENTO (para REC31-61100A1)	SHIM (For REC31-61100A1)	SPESSORE (Per REC31-61100A1)	SUPPLEMENT (Pour REC31-61100A1)
	REC15-32563A1	15-32563A1	SUPLEMENTO (Para REC31-35988A12)	SHIM (For REC31-35988A12)	SPESSORE (Per REC31-35988A12)	SUPPLEMENT (Pour REC31-35988A12)
5	REC31-61100A1	31-61100A1	COJINETE Ø EXT. 49 mm	BEARING ASSY EXT. Ø 49 mm	CUSCINETTO Ø EST. 49 mm	ROULEMENT Ø EXT. 49 mm
	REC31-32575T1	31-32575T1	COJINETE Ø EXT. 45 mm	BEARING ASSY EXT.L Ø 45 mm	CUSCINETTO Ø EST. 45 mm	ROULEMENT Ø EXT. 45 mm
6	REC45-55796	45-55796	EJE PIÑÓN	DRIVE SHAFT	ASSE PIGNONE	ARBRE PIGNON
7	REC25-55801	25-55801	ARO TÓRICO	O-RING	O-RING	JOINT TORIQUE
	RM43-66773A3	43-66773A3	KIT PIÑONES (Red. 1.32) (16-20)	GEAR SET (1.32) (16-20)	KIT PIGNONI (Rid. 1.32) (16-20)	KIT PIGNON (Réd. 1.32) (16-20)
	REC43-18411A2	43-18411A2	KIT PIÑONES H.D. (Red.1.50) (20-22)	GEAR SET HD (1.50) (20-22)	KIT PIGNONI RINFORZATI (Rid.1.50) (20-22)	KIT PIGNON HD (Réd. 1.50) (20-22)
8	REC43-45814A5	43-45814A5	KIT PIÑONES (Red.1.65) (24-24)	GEAR SET (1.65) (24-24)	KIT PIGNONI (Rid.1.65) (24-24)	KIT PIGNON (Réd. 1.65) (24-24)
	REC43-75325A3	43-75325A3	KIT PIÑONES H.D. (Red.1.84) (17-19)	GEAR SET HD (1.84) (17-19)	KIT PIGNONI RINFORZATI (Rid.1.84) (17-19)	KIT PIGNON HD (Réd. 1.84) (17-19)
	REC43-55778A3	43-55778A3	KIT PIÑONES (Red.1.98) (20-24)	GEAR SET (1.98) (20-24)	KIT PIGNONI (Rid.1.98) (20-24)	KIT PIGNON (Réd. 1.98) (20-24)
	REC31-32573A1	31-32573A1	RODAMIENTO (Red.1.50) ANTIGUA	ROLLER BEARING (1.50) OLD	CUSCINETTO (Rid.1.50) VECCHIO	ROULEMENT (Réd. 1.50) ANCIEN
9	REC31-35990A1	31-35990A1	RODAMIENTO (Red.1.65-1.84-1.98)	ROLLER BEARING (1.65-1.84-1.98)	CUSCINETTO (Rid.1.65-1.84-1.98)	ROULEMENT (Réd. 1.65-1.84-1.98)
	REC31-66818A1	31-66818A1	RODAMIENTO (Red.1.32)	ROLLER BEARING (1.32)	CUSCINETTO (Rid.1.32)	ROULEMENT (Réd. 1.32)
10	REC15-36178A02	15-36178A02	SUPLEMENTO	SHIM	SPESSORE	SUPPLEMENT
11	REC26-32511	26-32511	RETÉN	OIL SEAL	PARAOLIO	JOINT D'HUILE
12	REC26-965031	26-965031	RETÉN	OIL SEAL	PARAOLIO	JOINT D'HUILE
13	REC10-79953Q04	10-79953Q04	TAPÓN ACEITE	SCREW	TAPPO OLIO	BOUCHON D'HUILE
14	REC12-191833	12-191833	JUNTA TAPÓN	WASHER	GUARNIZIONE TAPPO	JOINT BOUCHON
15	REC19-47579	19-47579	TAPA PLÁSTICO	PLUG	COPERCHIO IN PLASTICA	COUVERCLE PLASTIC
16	REC10-28668	10-28668	TORNILLO	SCREW	VITE	VIS
17	REC27-558101	27-55810 1	JUNTA	GASKET	GUARNIZIONE	JOINT
18	REC26-36557	26-36557	CASQUILLO GOMA	GROMMET	BOCCOLA IN GOMMA	JOINT CAOUTCHOUC
19	REC32-54236	32-54236	TUBO DE GOMA	WATER TUBE	TUBO IN GOMMA	DURITE CAOUTCHOUC
20	REC42724A3	42724A3	KIT REFRIGERACIÓN	WATER POCKET COVER KIT	KIT RIPARAZIONE	KIT REPARATION
21	REC11-34933	11-859116	TUERCA	NUT	DADO	ÉCROU
22	REC621041	621041	EJE SELECTOR	SELECTOR SHAFT	ASSE SELETORE	ARBRE
23	REC18-32665	18-32665	PASADOR	PIN	FERMO	GOUPILLE
24	REC12-32666	12-32666	ARANDELA	WASHER	RONDELLA	RONDELLE
25	REC23-32632	23-32632	CASQUILLO	BUSHING	BOCCOLA	BAGUE
26	REC19-42682	19-42682	TAPÓN	WELCH PLUG (1-174 O.D.)	TAPPO	BOUCHON
27	REC22-428611	22-428611	TAPA TAPÓN	PIPE PLUG	COPERCHIO TAPPO	CUVERCLE BOUCHON
28	REC11-22339	11-22339	TUERCA	NUT	DADO	ÉCROU
29	REC12-45810	12-45810	ARANDELA TOPE	WASHER	RONDELLA	RONDELLE
30	REC15-71013	15-71013	SUPLEMENTO	SHIM	SPESSORE	SUPPLEMENT
31	REC15-35980A1	15-35980A1	SUPLEMENTO	SHIM	SPESSORE	SUPPLEMENT
32	REC31-35988A12	31-35988A12	RODAMIENTO (excepto 1.32)	ROLLER BEARING (except 1.32)	CUSCINETTO (eccetto 1.32)	ROULEMENT (except 1.32)
33	REC26-823894	26-823894	RETÉN	OIL SEAL	PARAOLIO	JOINT D'HUILE
34	REC66081A2	66081A2	CIERRE CARCASA	CARRIER ASSEMBLY	CHIUSURA CARCASSA	JOINT SPI DE CARDAN
35	REC25-70937	25-70937	ARO TÓRICO	O-RING	O-RING	JOINT TORIQUE
36	REC35983	35983	ARO METÁLICO	RING	O-RING METALLICO	BAGUE METALLIQUE
37	REC8168112	8168112	TUERCA PORTA RETÉN	RETAINER	DADO, SEDE PARAOLIO	ÉCROU À CRENAUX
38	REC46020T02	46020T02	EJE CORTO CARDÁN	YOKE	ASSE CARDANO	CARDAN
	REC3850812	75832T1	CRUCETA CARDÁN	U-JOINT	CROCIERA CARDANO	CROISILLON CARDAN
39	REC75832T	75832T	CRUCETA CARDÁN (4 en línea y V6 )	U-JOINT (4 inline & V6)	CROCIERA CARDANO (4 in linea e V6)	CROISILLON CARDAN (4 en ligne et V6)
	REC805536A2	805536A2	CRUCETA AUTOENGRASE	U-JOINT SELF GREASE	CROCIERA AUTOINGRASSANTE	CROISILLON DE CARDAN
40	REC393831	393831	RÓTULA CARDÁN	SOCKET	SEDE CARDANO	CARDAN
41	REC59830A7	59830A7	EJE LARGO CARDÁN (9-9/16")	YOKE ASSEMBLY (9-9/16")	ASSE CARDANO (9-9/16")	CARDAN (9-9/16")
42	REC814819A2	814819A2	CARDÁN COMPLETO	U-JOINT ASSEMBLY	CARDANO COMPLETO	CARDAN COMPLET
43	REC25-25439	25-25439	ARO TÓRICO	O-RING	O-RING	JOINT TORIQUE
44	REC27-64818Q4	26-64818Q4 27-64718A1	KIT DE JUNTAS	GASKET KIT	KIT GUARNIZIONE	KIT JOINTS
45	REC26-32511A1	26-32511A1	KIT DE JUNTAS	GASKET KIT	KIT GUARNIZIONE	KIT JOINTS
46	REC43-18411A2	43-18411A4	KIT PIÑONES Y COJINETE Reforzados 20/22 (Red. 1.50) Para V8.	DRIVE SHAFT HOUSING GEAR SET Heavy duty 20/22 (ratio 1.50) for V8	KIT PIGNONI E CUSCINETTI Rinforzati 20/22 Denti (Rid. 1.50) Per V8.	KIT PIGNON ET ROULEMENTS Renforcé 20/22 (Réd. 1.50) Pour V8.
47	RECKITMALPHA1AL		KIT ÁNODOS ALUMINIO	ANODES KIT AL	KIT ANODI AL	KIT ANODES AL

MC1 / R

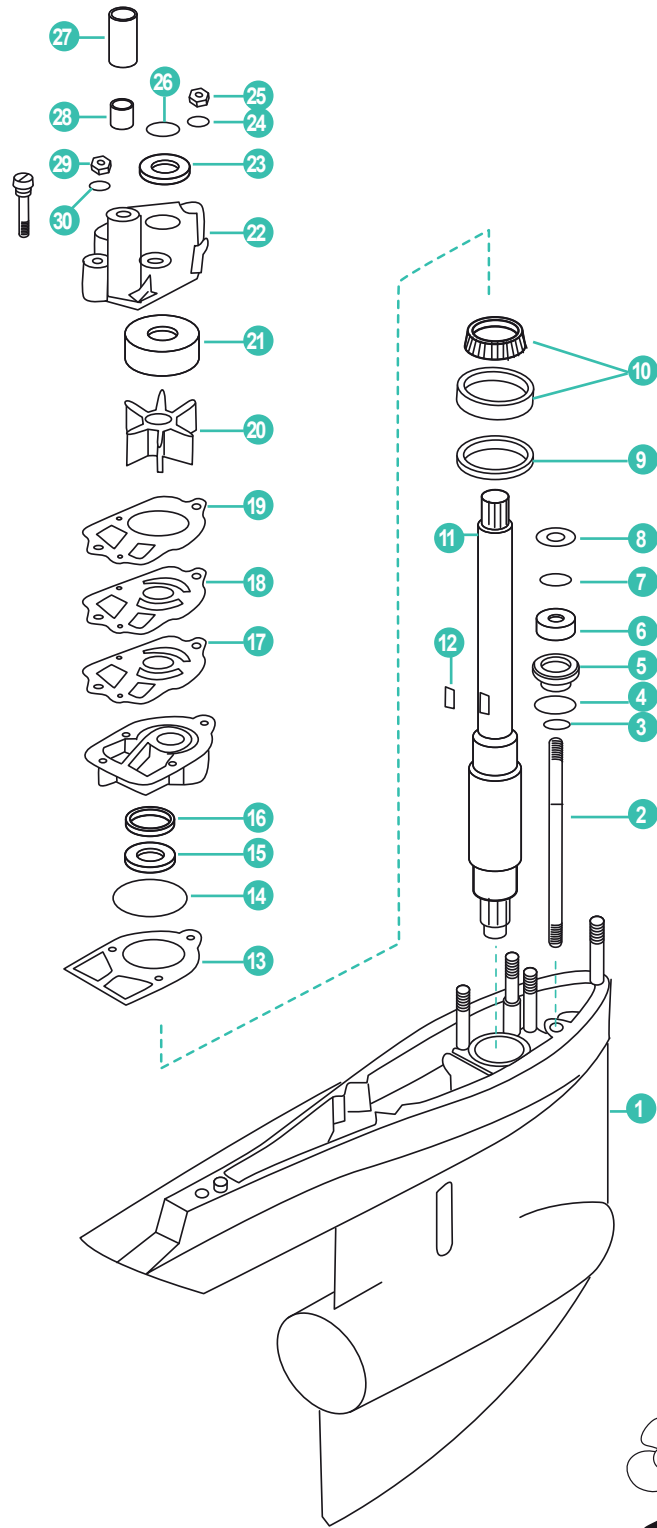



	REF	OEM				
1	REC1623-5356A4	1623-5356A4	CARCASA	HOUSING	CARCASSA	ENSEMBLE BOITIER DE VITESSE
2	REC774811	774811	EJE TRANSMISIÓN	SHIFT	ASSE	ARBRE
3	REC12-27880	12-27880	ARO	O-RING	O-RING	JOINT TORIQUE
4	REC25-25439	25-25439	ARO TÓRICO	O-RING	TENUTA	JOINT TORIQUE
5	REC23-30617A2	23-30617A2	ACOPLE EJE	ATTACHING SHAFT	FISSAGGIO ASSE	BUSING DE L'ARBRE DE TRANSMISSION
6	REC26-8164641	26-8164641	RETÉN	SEAL	TENUTA	JOINT D'HUILE
7	REC12-31266	12-31266	ARANDELA	WASHER	RONDELLA	RONDELLE
8	REC8M0042641	12-8M0042641	ARANDELA	WASHER	RONDELLA	RONDELLE
9	REC15-57007A1	15-57007A1	SUPLEMENTO	SPACER	DISTANZIALE	SUPPLEMENT
10	REC31-53079A1	31-53079A1	RODAMIENTO	BEARING	CUSCINETTO	ROULEMENT
11	REC45-41939F1	45-41939F1	EJE TRANSMISIÓN	TRANSMISSION SHAFT	ASSE TRASMISSIONE	ARBRE TRANSMISSION
12	REC8M0032834	28-8M0032834	CHAVETA	KEY	CHIAVETTA	CLAVETTE
13	REC27-856704	27-856704	JUNTA	GASKET	GUARNIZIONE	JOINT
14	REC25-33145	25-33145	ARO TÓRICO	O-RING	O-RING	JOINT TORIQUE
15	REC26-89238	26-89238	RETÉN	SEAL	TENUTA	JOINT D'HUILE
16	REC26-16977	26-16977	RETÉN	SEAL	TENUTA	JOINT D'HUILE
17	REC27-856081	27-856081	JUNTA BOMBA	PUMP GASKET	GUARNIZIONE POMPA	JOINT POMPE
18	REC324351	324351	TAPA BOMBA AGUA	COVER	COPERCHIO POMPA ACQUA	COUVERCLE POMPE À EAU
19	REC27-858524	27-858524	JUNTA TAPA BOMBA	COVER GASKET	GUARNIZIONE COPERCHIO	JOINT COUVERCLE POMPE
20	REC47-89984T4	47-89984T4	IMPULSOR	IMPELLER	GIRANTE	TURBINE
21	REC48752T	48752T	CASQUILLO BOMBA	INSERT	BOCCOLA	INSERT
22	REC46-96148T1	46-96148T1	CUERPO BOMBA AGUA	HOUSING WATER PUMP	CORPO POMPA ACQUA	CORPS POMPE À EAU
23	REC25-30271	25-30271	ARANDELA	WASHER	RONDELLA	RONDELLE
24	PAGB/T97.1-8	12-36001	ARANDELA	WASHER	RONDELLA	RONDELLE
25	REC11-13436	11-13436	TUERCA	NUT	DADO	ÉCROU
26	REC25-30613	25-30613	ANILLO GOMA	RUBBER RING	TENUTA	JOINT À CAOUTCHOUC
27	REC23-29804T	23-29804T	TUBO GUÍA	WATER PIPE	TUBO	TUYAU
28	REC26-38970	26-38970	RETÉN	OIL SEAL	TENUTA	JOINT D'HUILE
29	REC11-8267089	11-8267089	TUERCA	NUT	DADO	ÉCROU
30	PAGB/T848-6	12-29245	ARANDELA	WASHER	RONDELLA	RONDELLE
31	REC12110		KIT REPARACIÓN (1970-83)	SEAL KIT (1970-83)	KIT RIPARAZIONE (1970-83)	KIT POMPE (1970-83)
32	REC47-89984Q5		KIT REPARACIÓN	SEAL KIT	KIT RIPARAZIONE	KIT POMPE
33	REC46-64141A11		KIT REPARACIÓN MC1 (-1968)	SEAL KIT MC1 (-1968)	KIT RIPARAZIONE MC1 (-1968)	KIT POMPE MC1 (-1968)
34	REC26-33144A2	26-33144A2	KIT REPARACIÓN	SEAL KIT	KIT RIPARAZIONE	KIT POMPE



MC1 / R

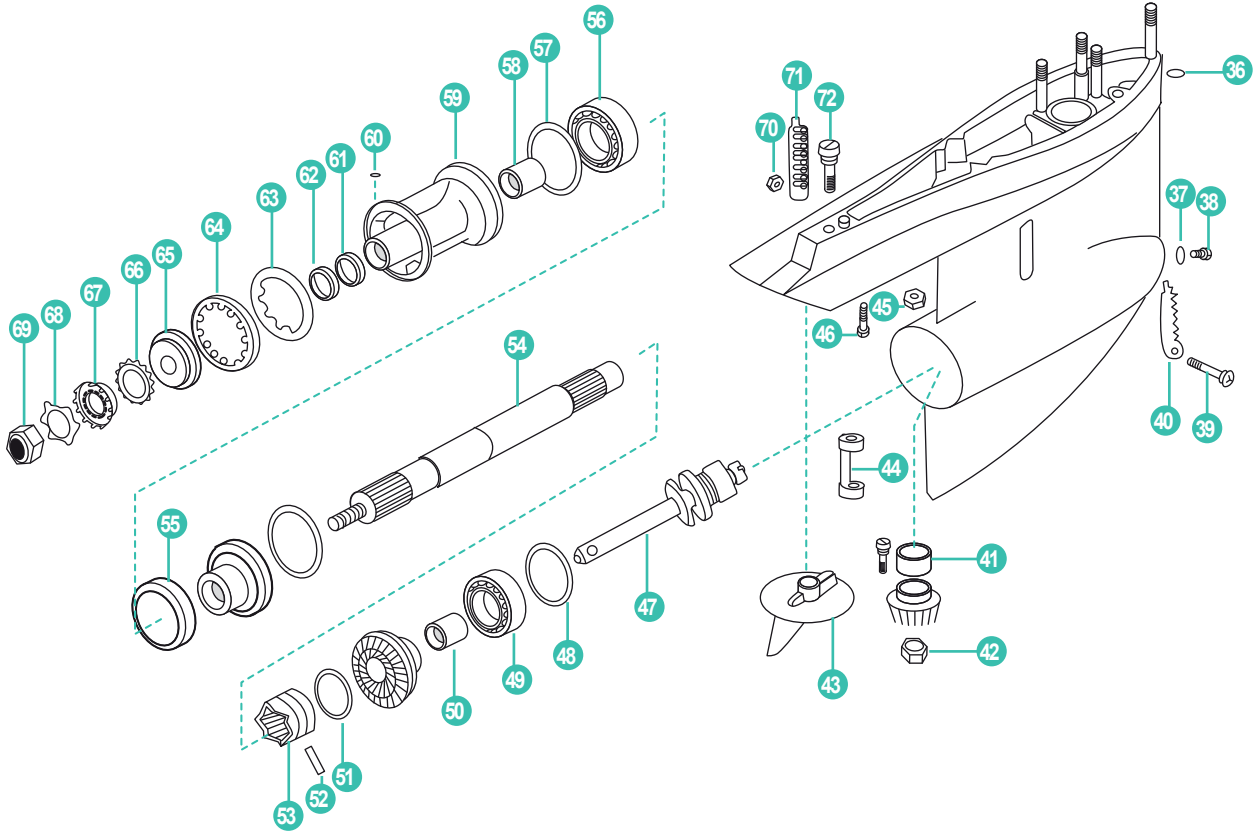

	REF	OEM				
36	REC26-455771	26-455771	RETÉN	SEAL	TENUTA	JOINT D'HUILE
37	REC12-191833	12-191833	JUNTA	GASKET	GUARNIZIONE	JOINT
38	REC22-67892A05	8M0058389	TORNILLO CON RETÉN	SCREW WITH SEAL	VITE CON TENUTA	VIS AVEC JOINT
39	REC10-76156	10-76156	TORNILLO	SCREW	VITE	VIS
40	REC934231	934231	TAPA REFRIGERACIÓN	CAP	COPERCHIO	COUVERCLE
41	REC31-92366A1	31-92366A1	RODAMIENTO	BEARING	CUSCINETTO	ROULEMENT
42	REC11-35921	11-35921	TUERCA PIÑÓN	PINION NUT	PIGNONE DADO	PIGNON ÉCROU
43	CM31640	31640Q4	ANODO TIMÓN ZN	ZN ANODE	ANODO ZN	ANODE ZN
	CM31640A	31640Q4	ANODO TIMÓN AL	AL ANODE	ANODO AL	ANODE AL
44	REC76865	76865	HORQUILLA CAMBIO	CLIP	CLIP CAMBIO	FOURCHETTE
45	REC11-34933	11-859116	TUERCA	NUT	DADO	ÉCROU
46	REC10-30206	10-30206	TORNILLO	SCREW	VITE	VIS
47	REC818349T1	818349T1	EJE DESPLAZABLE	SLIDE SHIFT	PASSANTE	SELECTEUR D'INVERSEUR
48	REC15-47397A1	15-47397A1	ARANDELA	WASHER	RONDELLA	RONDELLE
49	REC31-35928T1	31-35928T1	RODAMIENTO	BEARING	CUSCINETTO	ROULEMENT
50	REC31-30895T	31-30895T	RODAMIENTO	BEARING	CUSCINETTO	ROULEMENT
51	REC31-30895T	24-30893	MUELLE	SPRING	MOLLA	RESSORT
52	REC17-8M0084681	8M0020941	PASADOR	PIN	SPINOTTO	GOUPILLE
53	REC52-853594T	52-853594T	PIÑÓN CAMBIO	SHAFT PINION	PIGNONE CAMBIO	PIGNON CHANGEMENT
54	REC44-824110	44-824110	EJE HÉLICE	SHAFT PROPELLER	ASSE ELICA	ARBRE HÉLICE
55	REC35915	35915	SEPARADOR PIÑÓN	SPACER PINION	DISTANZIALE PIGNONE	ENTRETOISE DE PIGNON
56	REC30-88957T	30-88957T	RODAMIENTO	BEARING	CUSCINETTO	ROULEMENT
57	REC25-31534	25-31534	ARO TÓRICO	O-RING	ANELLO	JOINT TORIQUE
58	REC387247	31-30956T	RODAMIENTO	BEARING	CUSCINETTO	ROULEMENT
59	REC818763A10	818763A10	COJINETE COLA	SHAFT BEARING	CUSCINETTO PIEDE	ROULEMENT EMBASE
60	REC28-30281	28-30281	CIERRE	CAP	CHIUSURA	CLAVETTE
61	REC26-76868	26-76868	RETÉN INTERIOR	INNER SEAL	TENUTA INTERNO	JOINT TORIQUE
62	REC26-12224	26-12224	RETÉN EXTERIOR	OUTLER SEAL	TENUTA ESTERNO	JOINT D'HUILE
63	REC14-79447	14-79447	ARANDELA CIERRE	WASHER CAP	RONDELLA CHIUSURA	RONDELLE
64	REC8M2011027	8M2011027	TUERCA	NUT	DADO	ÉCROU
65	REC12-835467Q01	12-835467Q01	SEPARADOR	SPACER	DISTANZIALE	RONDELLE D'HÉLICE
66	REC13-423511	13-42351-1	ARANDELA CIERRE	WASHER CAP	RONDELLA CHIUSURA	RONDELLE FREIN
67	REC12-31211Q03	12-31211Q03	CASQUILLO	INSERT, CARTDRIGE	GHIERA	RONDELLE FREIN DE DIABOLO
68	REC90508-ZW1-003	816629Q	ARANDELA TUERCA	WASHER NUT	RONDELLA DADO	RONDELLE ÉCROU
69	REC90301-ZW1-003	11-827614	TUERCA EJE	NUT SHAFT	DADO ASSE	ÉCROU D'ARBRE
70	REC11-859124	11-859124	TUERCA	NUT	DADO	ÉCROU
71	REC934241	934241	TAPA REFRIGERACIÓN	CAP	COPERCHIO	COUVERCLE
72	REC10-32470	10-32470	TORNILLO	SCREW	VITE	VIS
73	REC11-52707Q1	11-52707Q1	KIT CIERRE HÉLICE	PROPELLER NUT KIT	KIT CIUSSURA ELICHA	KIT ÉCROU D'HÉLICE
	RECKITM1ALPHA1AL		KIT ÁNODOS AL	ANODE KIT AL	KIT ANODI AL	KIT ANODES AL
	CMALPHAGEN1KITA		KIT ÁNODOS AL	ANODE KIT AL	KIT ANODI AL	KIT ANODES AL
74	CMALPHAGEN1KITM		KIT ÁNODOS MG	ANODE KIT MG	KIT ANODI MG	KIT ANODES MG
	TENKITALPHAONE/1		KIT ÁNODOS ZN	ANODE KIT ZN	KIT ANODI ZN	KIT ANODES ZN

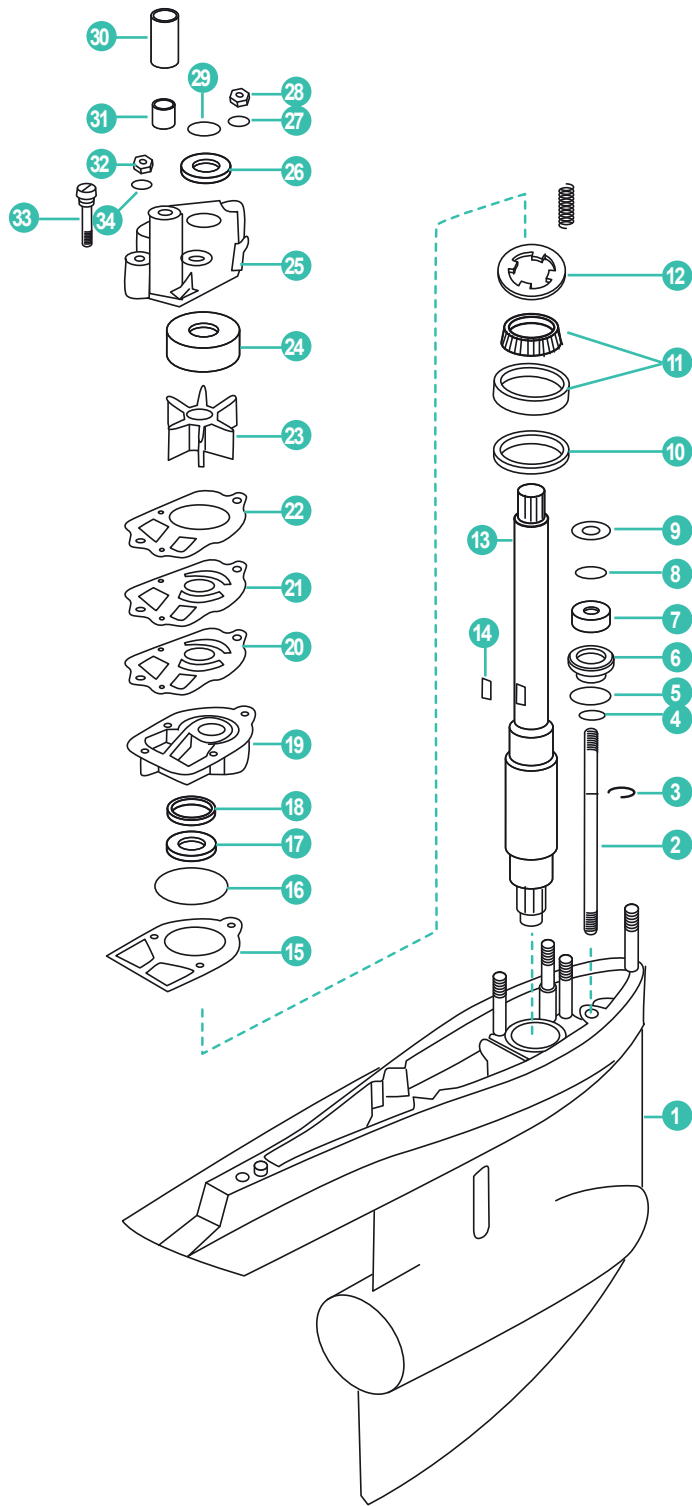



	REF	OEM				
1	REC1623-8951A37	1623-8951A37	CARCASA	HOUSING	CARASSA	CARTER EMBASE
2	REC774811	774811	EJE TRANSMISIÓN	SHIFT	ASSE	ARBRE TRANSMISSION
3	REC53-29641	53-29641	CLIP	LOCKER	CLIP	CLIPS
4	REC12-27880	12-27880	ARO	O-RING	O-RING	JOINT TORIQUE
5	REC25-25439	25-25439	ARO TÓRICO	O-RING	O-RING	JOIN TORIQUE
6	REC23-30617A2	23-30617A2	ACOPLE EJE	ATTACHING SHAFT	FISSAGGIO ASSE	BUSING DE L'ARBRE
7	REC26-8164641	26-8164641	RETÉN	SEAL	TENUTA	JOINT D'HUILE
8	REC12-31266	12-31266	ARANDELA	WASHER	RONDELLA	RONDELLE
9	REC8M0042641	8M0042641	ARANDELA	WASHER	RONDELLA	RONDELLE
10	REC15-42637A1	15-42637A1	GRUESO	SHIM	SPESSORE	KIT CALE D'EPaisseur
11	REC31-36387A1	31-36387A1	RODAMIENTO	BEARING	CUSCINETTO	ROULEMENT
12	REC8245191	8245191	ARANDELA	WASHER	RONDELLA	RONDELLE
13	REC45-42634	45-42634	EJE TRANSMISIÓN	TRANSMISSION SHAFT	ASSE TRASMISIONE	ARBRE DE TRANSMISSION
14	REC8M0032834	8M0032834	CHAVETA	KEY	CHIAVETTA	CLAVETTE
15	REC27-426311	27-42631-1	JUNTA	GASKET	GUARNIZIONE	JOINT
16	REC25-38099	25-38099	ARO TÓRICO (Ø 2.125")	O-RING (Ø 2.125")	O-RING (Ø 2.125")	JOINT TORIQUE (Ø 2.125")
	REC25-90011	25-90011	ARO TÓRICO (Ø 2.188")	O-RING (Ø 2.188")	O-RING (Ø 2.188")	JOINT TORIQUE (Ø 2.188")
17	REC26-89238	26-89238	RETÉN	SEAL	TENUTA	JOINT D'HUILE
18	REC26-16977	26-16977	RETÉN	SEAL	TENUTA	JOINT D'HUILE
19	REC46-44292Q03	46-44292Q03	BASE BOMBA	PUMP BASE	BASE POMPA	BASE POMPE
20	REC27-856081	27-856081	JUNTA BOMBA	PUMP GASKET	GUARNIZIONE POMPA	JOINT POMPE
21	REC324351	324351	TAPA BOMBA AGUA	COVER	COPERCHIO	COUVERCLE POMPE
22	REC27-858524	27-858524	JUNTA TAPA BOMBA	COVER GASKET	GUARNIZIONE COPERCHIO	JOINT COUVERCLE
23	REC47-89984T4	47-89984T4	IMPULSOR	IMPELLER	GIRANTE	TURBINE
24	REC48752T	48752T	CASQUILLO BOMBA	INSERT	BOCCOLA	INSERT
25	REC46-96148T1	46-96148T1	CUERPO BOMBA AGUA	HOUSING WATER PUMP	CORPO POMPA ACQUA	CORPS POMPE
26	REC25-30271	25-30271	RETÉN	SEAL	TENUTA	JOINT
27	PAGB/T97.1-8	12-36001	ARANDELA	WASHER	RONDELLA	RONDELLE
28	REC11-13436	11-13436	TUERCA	NUT	DADO	ÉCROU
29	REC25-30613	25-30613	ARO TÓRICO	O-RING	O-RING	JOINT TORIQUE
30	REC23-29804T	23-29804T	TUBO GUÍA	WATER PIPE	TUBO	TUYAU
31	REC26-38970	26-38970	RETÉN	SEAL	TENUTA	JOINT
32	REC11-8267089	11-8267089	TUERCA	NUT	DADO	ÉCROU
33	REC10-96411	10-96411	TORNILLO	SCREW	VITE	VIS
34	PAGB/T848-6	12-29245	ARANDELA	WASHER	RONDELLA	RONDELLE
35	REC12120		KIT REPARACIÓN	SEAL KIT	KIT RIPARAZIONE	KIT POMPE A EAU
36	REC47-89984Q5		KIT REPARACIÓN	SEAL KIT	KIT RIPARAZIONE	KIT POMPE A EAU
37	REC26-33144A2	26-33144A2	KIT REPARACIÓN	SEAL KIT	KIT RIPARAZIONE	KIT POMPE A EAU

MR / ALPHA ONE

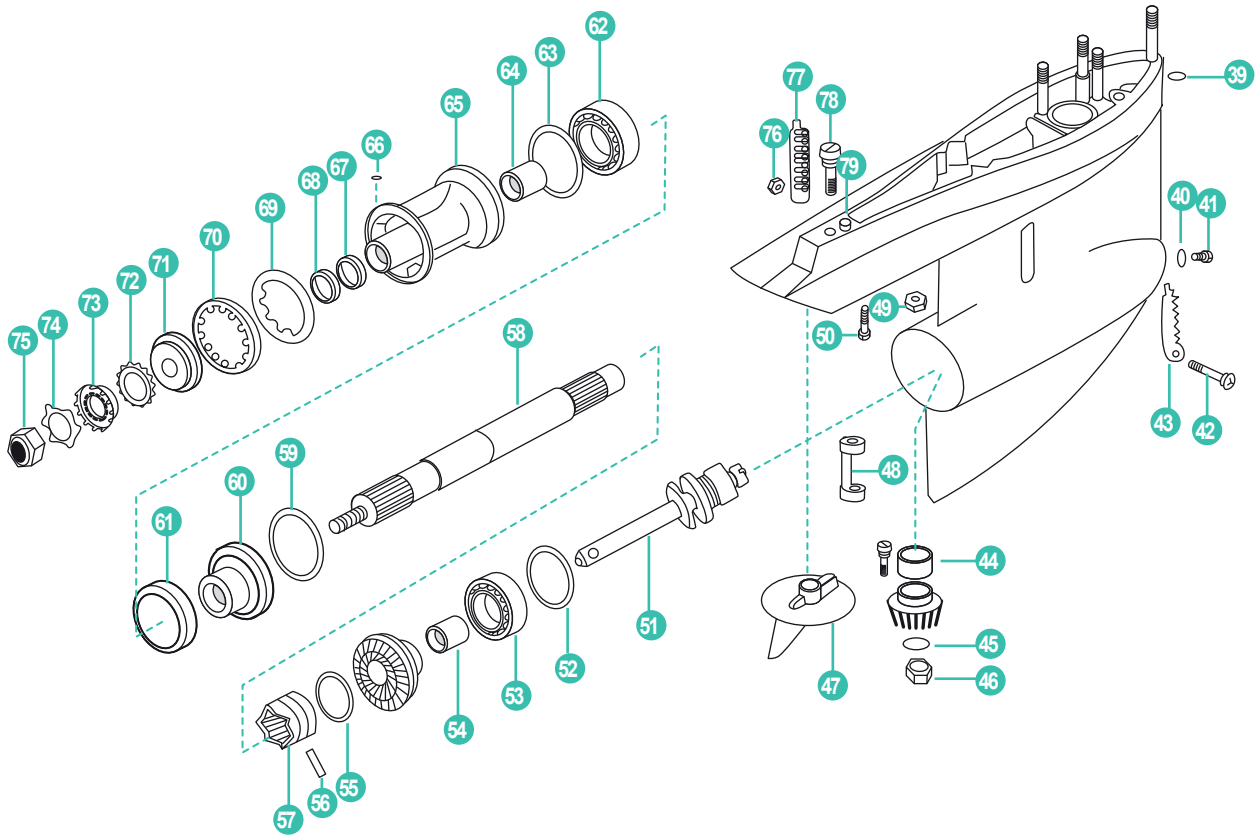

P  
25



	REF	OEM				
39	REC26-455771	26-45577 1	RETÉN	SEAL	TENUTA	JOINT D'HUILE
40	REC12-191833	12-191833	JUNTA	GASKET	GUARNIZIONE	JOINT
41	REC22-67892A05	8M0058389	TORNILLO CON RETÉN	SCREW WITH SEAL	VITE CON TENUTA	VIS AVEC JOINT
42	REC10-76156	10-76156	TORNILLO	SCREW	VITE	VIS
43	REC934231	934231	TAPA REFRIGERACIÓN	CAP	COPERCHIO	COUVERCLE
44	REC387817	31-42647A1	RODAMIENTO	BEARING	CUSCINETTO	ROULEMENT
45	REC350038	12-92721	CIERRE	CAP	CHIUSURA	JOINT
46	REC11-35921	11-35921	TUERCA PIÑÓN	PINION NUT	DADO PIGNONE	ÉCROU PIGNON
47	CM31640	31640Q4	ANODO TIMÓN ZN	ZN SHAFT ANODE	ANODO ZN	ANODE ZN
	CM31640A	31640Q4	ANODO TIMÓN AL	AL SHAFT ANODE	ANODO AL	ANODE AL
48	REC76865	76865	HORQUILLA CAMBIO	CLIP	CLIP	FOURCHETTE
49	REC11-34933	11-859116	TUERCA	NUT	DADO	ÉCROU
50	REC10-30206	10-30206	TORNILLO	SCREW	VITE	VIS
51	REC818349T1	818349T1	EJE DESPLAZABLE	SLIDE SHIFT	PASSANTE	SELECTEUR D'INVERSEUR
52	REC15-47397A1	15-47397A1	ARANDELA	WASHER	RONDELLA	RONDELLE
53	REC31-35928T1	31-35928T1	RODAMIENTO Ø 47,6 mm	BEARING Ø 47.6 mm	CUSCINETTO Ø 47.6 mm	ROULEMENT Ø 47,6 mm
	REC31-828437A2	31-828437A2	RODAMIENTO Ø 44,4 mm	BEARING Ø 44.4 mm	CUSCINETTO Ø 44.4 mm	ROULEMENT Ø 44.4 mm
54	REC31-30895T	31-30895T	RODAMIENTO	BEARING	CUSCINETTO	ROULEMENT
55	REC24-30893	24-30893	MUELLE	SPRING	MOLLA	RESSORT
56	REC17-8M0084681	8M0020941	PASADOR	PIN	SPINOTTO	GOUPILLE
57	REC52-853594T	52-853594T	PIÑÓN CAMBIO	SHAFT PINION	PIGNONE CAMBIO	CRABOT
58	REC44-824110	44-824110	EJE HÉLICE	SHAFT PROPELLER	ASSE ELICA	ARBRE D'HÉLICE
	REC44-8146061	44-8146061	EJE HÉLICE	SHAFT PROPELLER	ASSE ELICA	ARBRE D'HÉLICE
59	REC23-824108	23-824108	ESPACIADOR	SPACER	DISTANZIALE	CALE
60	REC43-828073A1	43-828073A1	PIÑÓN MARCHA A ATRÁS	PINION REVERSE	PIGNONE RETROMARCIA	PIGNON MARCHE ARRIÈRE
61	REC681001	681001	SEPARADOR PIÑÓN	PINION SPACER	DISTANZIALE PIGNONE	CALE
62	REC30-88957T	30-88957T	RODAMIENTO	BEARING	CUSCINETTO	ROULEMENT
63	REC25-31534	25-31534	ARO TÓRICO	O-RING	ANELLO	JOINT TORIQUE
64	REC387247	31-30956T	RODAMIENTO	BEARING	CUSCINETTO	ROULEMENT
65	REC818763A10	818763A10	COJINETE COLA	SHAFT BEARING	CUSCINETTO PIEDE	DIABOLO
	REC14587A7	14587A5	COJINETE COLA	SHAFT BEARING	CUSCINETTO PIEDE	DIABOLO
66	REC28-30281	28-30281	CHAVETA	KEY	CHIAVETTA	CLAVETTE
67	REC26-76868	26-76868	RETÉN INTERIOR	INNER SEAL	TENUTA INTERNO	JOINT TORIQUE
68	REC26-12224	26-12224	RETÉN EXTERIOR	OUTLER SEAL	TENUTA ESTERNO	JOINT TORIQUE
69	REC14-18323	14-18323	ARANDELA CIERRE	WASHER	RONDELLA CHIUSURA	RONDELLE
70	REC8M2011027	8M2011027	TUERCA	NUT	DADO	ÉCROU
71	REC12-835467Q01	12-835467Q01	SEPARADOR	SPACER	DISTANZIALE	CALE
72	REC13-423511	13-423511	ARANDELA CIERRE	WASHER	RONDELLA CHIUSURA	RONDELLE
73	REC12-31211Q03	12-31211Q03	CASQUILLO	INSERT	BOCCOLA	INSERT
74	REC90508-ZW1-003	14-816629Q	ARANDELA TUERCA	WASHER NUT	RONDELLA DADO	RONDELLE ÉCROU
75	REC90301-ZW1-003	11-827614	TUERCA EJE	SHAFT NUT	DADO ASSE	ÉCROU ARBRE
76	REC11-859124	11-859124	TUERCA	NUT	DADO	ÉCROU
77	REC934241	934241	TAPA REFRIGERACIÓN	CAP	COPERCHIO	COUVERCLE
78	REC10-32470	10-32470	TORNILLO	SCREW	VITE	VIS
79	REC331880	17-35973	PASADOR	PIN	SPINOTTO	GOUPILLE
80	REC11-52707Q1	11-52707Q1	KIT CIERRE HÉLICE	PROPELLER NUT KIT	KIT CHIUSURA ELICHA	KIT ÉCROU D'HÉLICE
81	RECKITMALPHA1AL		KIT ÁNODOS AL	ANODE KIT AL	KIT ANODI AL	KIT ANODES AL
	CMALPHAGEN1KITA		KIT ÁNODOS AL	ANODE KIT AL	KIT ANODI AL	KIT ANODES AL
	CMALPHAGEN1KITM		KIT ÁNODOS MG	ANODE KIT MG	KIT ANODI MG	KIT ANODES MG
	TENKITALPHAONE/1		KIT ÁNODOS ZN	ANODE KIT ZN	KIT ANODI ZN	KIT ANODES ZN
82	CM806105	806105Q1	ÁNODO EJE HÉLICE ZN	PROP SHAFT ANODE ZN	ANODO ELICHA ZN	ANODE EMBASE ZN
	CM806105A	806105Q1	ÁNODO EJE HÉLICE AL	PROP SHAFT ANODE AL	ANODO ELICHA AL	ANODE EMBASE AL



CONTRAROTACIÓN  
ROTACIÓN ESTÁNDAR

COUNTER ROTATION  
STD ROTATION

CONTROROTANTE  
ROTAZIONE STD

CONTRAROTATION  
ROTATION STD

ALPHA ONE GEN II  
OD469859-0K999999 (1991-97)

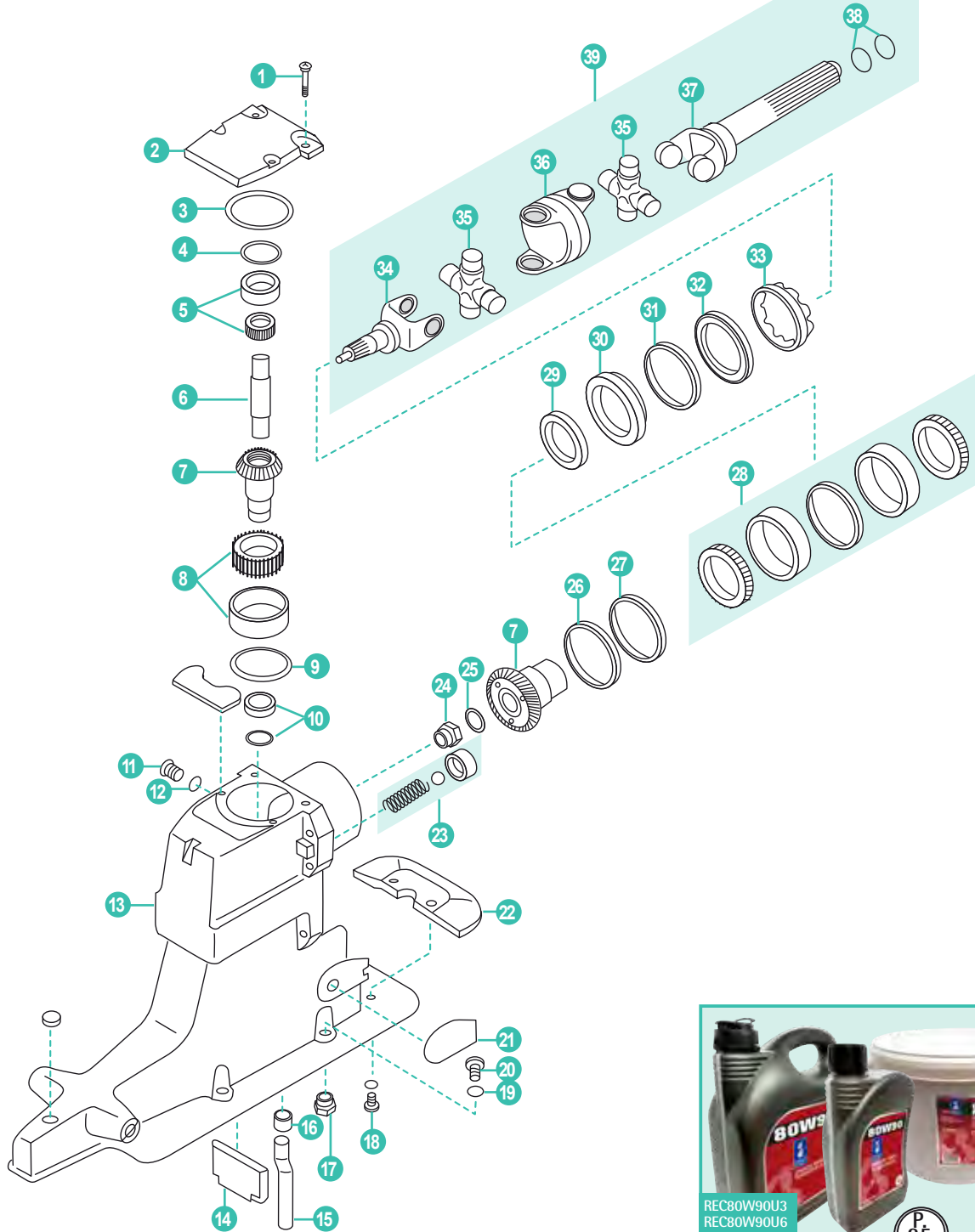



	REF	OEM				
1	REC10-98794	10-98794	TORNILLO	SCREW	VITE	VIS
2	REC828692A1	828692A1	TAPA SUPERIOR CON NIVEL DE ACEITE	UPPER CAP WITH OIL LEVEL	COPERCHIO SUPERIORE CON LIVELLO OLIO	KIT CAPOT SUPERIEUR
3	REC25-32546	25-32546	ARO TÓRICO	O-RING	O-RING	JONT TORIQUE
4	REC15-45691A1	15-45691A1	GRUESO (Para rodamiento 21510)	SHIM (For bearing 21510)	SPESSORE (Per cuscinetto 21510)	CALE (pour roulement 21510)
	REC15-32563A1	15-32563A1	GRUESO (Para rodamiento 21511)	SHIM (For bearing 21511)	SPESSORE (Per cuscinetto 21511)	CALE (pour roulement 21511)
5	REC31-61100A1	31-61100A1	RODAMIENTO Ø EXT.49 mm (1991-95)	BEARING Ø EXT. 49 mm (1991-95)	CUSCINETTO Ø EST. 49 mm (1991-95)	ROULEMENT Ø EXT. 49 mm (1991-95)
	REC31-32575T1	31-32575T1	RODAMIENTO Ø EXT.45 mm (-1996)	BEARING Ø EXT. 45 mm (-1996)	CUSCINETTO Ø EST. 45 mm (-1996)	ROULEMENT Ø EXT. 45 mm (-1996)
6	REC45-557961	45-55796-1	EJE PIÑÓN	PINION SHAFT	ASSE PIGNONE	ARBRE PIGNON
	REC43-18411A2	43-18411A2	KIT PIÑONES (Red.1.50/1.47) (20-22) 1991-97	PINION KIT (Ratio 1.50/1.47) (20-22) 1991-97	KIT PIGNONE (Rid. 1.50/1.47) (20-22) 1991-97	KIT PIGNON (Réd. 1.50/1.47) (20-22) 1991-97
	REC43-45814A5	43-45814A5	KIT PIÑONES (Red 1.65/1.62) (24-24) 1991-97	PINION KIT (Ratio 1.65/1.62) (24-24) 1991-97	KIT PIGNONE (Rid. 1.65/1.62) (24-24) 1991-97	KIT PIGNON (Réd. 1.65/1-62) (24-24) 1991-97
7	REC43-75325A3	43-75325A3	KIT PIÑONES (Red 1.84/1.81) (17-19) 1991-97	PINION KIT (Ratio 1.84/1.81) (17-19) 1991-97	KIT PIGNONE (Rid. 1.84/1.81) (17-19) 1991-97	KIT PIGNON (Réd. 1.84/1.81) (17-19) 1991-97
	REC43-55778A3	43-55778A3	KIT PIÑONES (Red 1.98/1.94) (20-24) 1991-97	PINION KIT (Ratio 1.98/1.94) (20-24) 1991-97	KIT PIGNONE (Rid. 1.98/1.94) (20-24) 1991-97	KIT PIGNON (Réd. 1.98/1.94) (20-24) 1991-97
8	REC31-35990A1	31-35990A1	RODAMIENTO (Red 1.65, 1.84, 1.98, 2.40)	BEARING (Ratio 1.65, 1.84, 1.98, 2.40)	CUSCINETTO (Rid. 1.65, 1.84, 1.98, 2.40)	ROULEMENT (Réd. 1.65, 1.84, 1.98, 2.40)
	REC31-32573A1	31-32573A1	RODAMIENTO (Red. 1.47)	BEARING (Ratio 1.47)	CUSCINETTO (Rid.1.47)	ROULEMENT (Réd. 1.47)
9	REC15-36178A02	15-36178A02	SUPLEMENTO	SPACER	DISTANZIALE	CALE
10	REC26-66302	26-66302	RETÉN	SEAL	TENUTA	JOINT
11	REC10-79953Q04	10-79953Q04	TORNILLO COLA	SCREW	VITE	VIS
12	REC12-191833	12-191833	JUNTA	GASKET	GUARNIZIONE	JOINT
13	REC1547-815930A7	1547-815930A7	CARCASA	HOUSING	CARASSA	CARDAN
14	RM815932	815932	SEPARADOR ESCAPE	SPACER EXHAUST	SPAZIATORE SCARICO	CALE ÉCHAPPEMENT
15	REC32-860220	32-860220	TUBO SUBIDA AGUA	WATER UP TUBE	TUBO ASPIRAZIONE ACQUA	DURITE D'EAU
16	REC26-88397	26-88397	TUBO GOMA	RUBBER TUBE	TUBO GOMMA	DURITE CAOUTCHOUC
17	REC11-859135	859135	TUERCA	NUT	DADO	ÉCROU
18	REC10-28668	10-28668	TORNILLO	SCREW	VITE	VIS
19	REC12-45176	12-35935	ARANDELA	WASHER	RONDELLA	RONDELLE
20	REC10-816601	10-816601	TORNILLO	SCREW	VITE	VIS
21	REC8M2015937	8M2015937	TAPA BABOR	PORT CAP	COPERCHIO SINISTRO	COUVERCLE BABOR
	REC8M2015938	8M2015938	TAPA ESTRIBOR	STD CAP	COPERCHIO DESTRO	COUVERCLE TRIBOR
22	CM821629	821629Q1	ANODO ZN	ZN ANODE	ANODO ZN	ANODE ZN
	CM821629A	821629Q1	ANODO AL	ALANODE	ANODO AL	ANODE AL
23	REC24-17997A1	24-17997A1	KIT MUELLE BOLA	SPRING BALL KIT	KIT MOLLA	KIT RESSORT
24	REC11-22339	11-22339	TUERCA	NUT	DADO	ÉCROU
25	REC12-45810	12-45810	ARANDELA	WASHER	RONDELLA	RONDELLE
26	REC15-71013	15-71013	ESPACIADOR	SPACER	DISTANZIALE	CALE
27	REC15-35980A1	15-35980A1	SUPLEMENTO	SPACER	DISTANZIALE	CALE
28	REC31-35988A12	31-35988A12	RODAMIENTO (1991-97)	BEARING (1991-97)	CUSCINETTO (1991-97)	ROULEMENT (1991-97)
29	REC26-823894	26-823894	RETÉN	SEAL	TENUTA	JOINT D'HUILE
30	REC66081A2	66081A2	CUERPO RETÉN CARDAN	HOUSING CARDAN SEAL	PARAOILIO CARDANO	CORPS JOINT DU CARDAN
31	REC25-70937	25-70937	ARO TÓRICO	O-RING	O-RING	JOINT TORIQUE
32	REC35983	35983	ARO	O-RING	O-RING	JOINT TORIQUE
33	REC8168112	8168112	TUERCA PORTA RETÉN	SEAL'S NUT	DADO PORTA TENUTA	ÉCROU A CRENAUX EMBASE
34	REC46020T02	46020T02	UNIÓN COLA-CARDAN (1991-97)	UNION DRIVE SHAFT-CARDAN (1991-97)	ASSE CARDANO PIEDE (1991-97)	CARDAN (1991-97)
	REC3850812	75832T1	CRUCETA (1991-95)	JOINT (1991-95)	CROCETTA (1991-95)	CROISILLON CARDAN (1991-95)
35	REC805536A2	805536A2	CRUCETA (1996+)	JOINT (1996+)	CROCETTA (1996+)	CROISILLON CARDAN (1996+)
	REC75832T	75832T	CRUCETA CARDÁN (4 en línea y V6) (-1995)	U-JOINT (4 inline & V6) (-1995)	CROCIERA CARDANO (4 in linea e V6) (-1995)	CROISILLON CARDAN (4 en ligne et V6) (-1995)
36	REC393831	393831	CARDAN	CARDAN	CARDAN	CARDAN
37	REC59830A7	59830A7	UNIÓN COLA - MOTOR	UNION DRIVE SHAFT - ENGINE	ASSE CARDANO PIEDE MOTORE	CARDAN EMBASE
38	REC25-25439	25-25439	ARO TORICO	O-RING	O-RING	JOINT TORIQUE
	REC25-35027	25-35027	ARO TÓRICO	O-RING	O-RING	JOINT TORIQUE
39	REC814819A2	814819A2	KIT TRANSMISIÓN (1991-97)	TRANSMISSION KIT (1991-97)	KIT TRASMISSIONE (1991-97)	ARBRE TRANSMISSION (1991-97)
	REC864281A2	864281A2	KIT TRANSMISIÓN (1998+)	TRANSMISSION KIT (1998+)	KIT TRASMISSIONE (1998+)	ARBRE TRANSMISSION (1998+)
40	REC26-88397A1	26-88397A1	KIT RETENES	GEARCASE SEAL KIT	KIT PARAOLIO	KIT JOINTS
41	REC27-94996Q2	27-94996Q2	KIT RETENES	GEARCASE SEAL KIT	KIT PARAOLIO	KIT JOINTS
	RECKITMALPHA2AL		KIT ÁNODOS AL	ANODE KIT AL	KIT ANODI AL	KIT ANODES AL
42	CMALPHAKITA		KIT ÁNODOS AL	ANODE KIT AL	KIT ANODI AL	KIT ANODES AL
	CMALPHAKITM		KIT ÁNODOS MG	ANODE KIT MG	KIT ANODI MG	KIT ANODES MG
	TENKITALPHAONE/2		KIT ÁNODOS ZN	ANODE KIT ZN	KIT ANODI ZN	KIT ANODES ZN
43	REC43-18411A2	43-18411A4	KIT PIÑONES Y COJINETE Reforzados 20/22 (Red. 1.50) Para V8.	DRIVE SHAFT HOUSING GEAR SET Heavy duty 20/22 (ratio 1.50) for V8	KIT PIGNONI E CUSCINETTI RINFORZATI 20/22 Denti (Rid. 1.50) Per V8	KIT PIGNONS ET ROULEMENTS Renforcé 20/22 (Réd. 1.50) Pour V8.

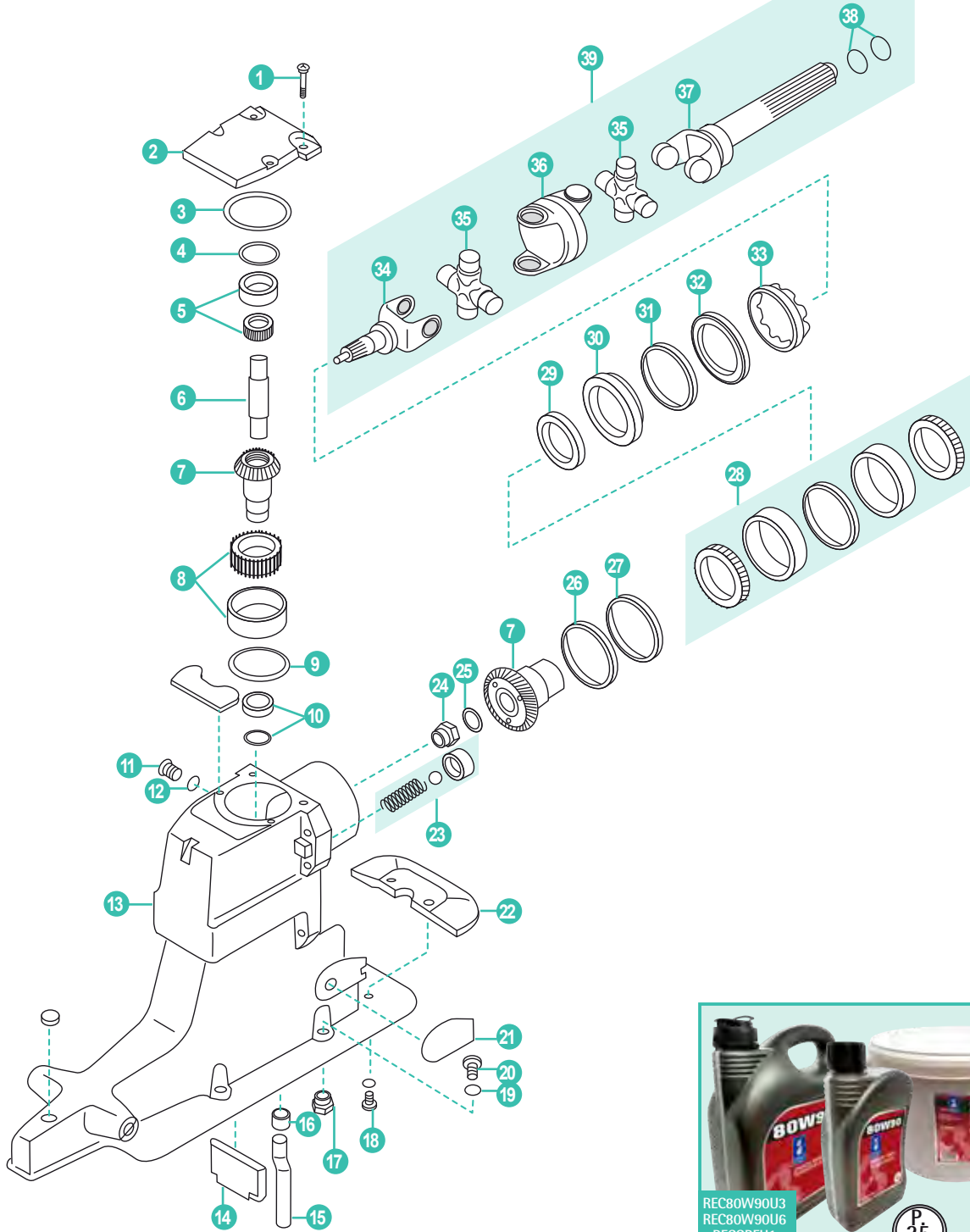

	REF	OEM				
1	REC10-98794	10-98794	TORNILLO	SCREW	VITE	VIS
2	REC828692A1	828692A1	TAPA SUPERIOR	COVER ASSEMBLY	COPERCHIO	COUVERCLE
3	REC25-32546	25-32546	ARO	O-RING	ANELLO	BAGUE
4	REC15-32563A1	15-32563A1	SUPLEMENTO (Cojinete 21511)	SHIM (FOR 21511 bearing)	ESPESTORE (cuscinetto 21511)	CALE (roulement 21511)
5	REC31-32575T1	31-32575T1	COJINETE (O.D. 1-25/32)	BEARING ASSY (O.D. 1-25/32)	CUSCINETTO (O.D. 1-25/32)	ROULEMENT (O.D. 1-25/32)
6	REC45-557961	45-557961	EJE	DRIVE SHAFT	ASSE	ARBRE
	REC43-853641A2	43-853641A2	KIT PIÑONES (Red. 1.47) (20-22)	GEAR SET (1.47 RATIO) (20-22)	KIT PIGNONE (Rid. 1.47) (20-22)	KIT PIGNON (Réd. 1.47) (20-22)
7	REC43-853640A2	43-853640A2	KIT PINONES (Red. 2.00/1.62) (24-24)	GEAR SET (2.00/1.62 RATIO) (24-24)	KIT PIGNONE (Rid. 2.00/1.62) (24-24)	KIT PIGNON (Réd. 2.00/1-62) (24-24)
	REC43-853643A2	43-853643A2	KIT PINONES (Red. 1.81) (17-19)	GEAR SET (1.81 RATIO) (17-19)	KIT PIGNONE (Rid. 1.81) (17-19)	KIT PIGNON (Réd. 1.81) (17-19)
	REC43-853642A2	43-853642A2	KIT PINONES (Red. 2.40/1.94) (20-24)	GEAR SET (2.40/1.94 RATIO) (20-24)	KIT PIGNONE (Rid. 2.40/1.94) (20-24)	KIT PIGNON (Réd. 2.40/1.94) (20-24)
8	REC31-35990A1	31-35990A1	COJINETE (Red. 1.62, 1.81, 1.94, 2.00, 2.40)	ROLLER BEARING (1.62, 1.81, 1.94, 2.00, 2.40 RATIO)	CUSCINETTO (Rid. 1.62, 1.81, 1.94, 2.00, 2.40)	KIT PIGNON (Réd. 1.61, 1.81, 1.94, 2.00, 2.40)
	REC31-32573A1	31-32573A1	COJINETE (Red. 1.47)	ROLLER BEARING (1.47 RATIO)	CUSCINETTO (Rid. 1.47)	ROULEMENT (Réd. 1.47)
9	REC15-36178A02	15-36178A02	SUPLEMENTO	SHIM	SPESTORE	CALE
10	REC26-66302	26-66302	RETÉN (-OM400411)	OIL SEAL (-OM400411)	PARAOLIO (-OM400411)	JOINT D'HUILE (-OM400411)
	REC26-864319	26-864319	RETÉN (OM400412+)	OIL SEAL (OM400412+)	PARAOLIO (OM400412+)	JOINT D'HUILE (OM400412+)
11	REC10-79953Q04	10-79953Q04	KIT TORNILLOS	SCREW KIT	KIT VITE	KIT VIS
12	REC12-191833	12-191833	ARANDELA	WASHER	RONDELLA	RONDELLA
13	REC1547-815930A7	1547-815930A7	CARCASA	HOUSING	CARCASSA	CARDAN
14	RM815932	815932	SEPARADOR ESCAPE	FILLER WALL	SEPARATORE	CALE ÉCHAPPEMENT
15	REC32-860220	32-860220	TUBO GUÍA	GUIDE TUBE	TUBO GUIDA	TUBO GUIDE
16	REC26-88397	26-88397	GRUESO	GROMMET	SPESTORE	CALE
17	REC11-859135	11-859135	TUERCA	LOCKNUT	DADO	ÉCROU
18	REC10-28668	10-28668	TORNILLO	SCREW	VITE	VIS
19	REC12-45176	12-35935	ARANDELA	WASHER	RONDELLA	RONDELLE
20	REC10-816601	10-816601	TORNILLO	BOLT	VITE	VIS
21	REC8M2015937	8M2015937	GRUESO BABOR	WEAR PAD - PORT	SPESTORE BABORDO	CALE BABORD
	REC8M2015938	8M2015938	GRUESO ESTRIBOR	WEAR PAD - STARBOARD	SPESTORE TRIBORDO	CALE TRIBORD
22	CM821629	821629Q1	ANODO ZN	ZN ANODE	ANODO ZN	ANODE ZN
	CM821629A	821629Q1	ANODO AL	AL ANODE	ANODO AL	ANODE AL
23	REC24-17997A1	24-17997A1	KIT BOLA ENGRASE	SPRINT KIT	KIT BOLLA INGRASSATORE	VALVE BY-PASS
24	REC11-22339	11-22339	TUERCA	NUT	DADO	ÉCROU
25	REC12-45810	12-45810	ARANDELA	WASHER	RONDELLA	RONDELLE
26	REC15-71013	15-71013	ESPACIADOR	SPACER	DISTANZIALE	CALE
27	REC15-35980A1	15-35980A1	SUPLEMENTO	SHIM	SPESTORE	SUPPLEMENT
28	RM31-30894A5	31-30894A5	KIT COJINETE	BEARING KIT	KIT CUSCINETTO	KIT ROULEMENT
29	REC26-823894	26-823894	RETÉN ACEITE	OIL SEAL	PARAOLIO	JOINT D'HUILE
30	REC66081A2	66081A2	CUERPO RETÉN CARDAN	HOUSING CARDAN SEAL	PARAOLIO CARDANO	CORPS JOINT DU CARDAN
31	REC25-70937	25-70937	ARO TÓRICO	O-RING	O-RING	JOINT TORIQUE
32	REC35983	35983	ARO	O-RING	O-RING	JOINT TORIQUE
33	REC8168112	8168112	RETENEDOR	RETAINER	TENUTA	JOINT D'HUILE
34	REC853635	853635	UNIÓN COLA CARDÁN (-OM400411)	YOKE (-OM400411)	UNIONE PIEDE -CARDAN (-OM400411)	CARDAN (-OM400411)
	REC864282T	864282T	UNIÓN COLA CARDÁN (OM4004112+)	YOKE (OM4004112+)	UNIONE PIEDE - CARDAN (OM400412+)	CARDAN (OM400412+)
35	REC805536A2	805536A2	CRUCETA CARDAN (-OM400411)	U-JOINT (-OM400411)	CROCETTA (-OM400411)	CROISILLON CARDAN (-OM400411)
	REC865496A02	865496A02	CRUCETA CARDAN (OM400412+)	U-JOINT (OM400412+)	CROCETTA (OM400412+)	CROISILLON CARDAN (OM400412+)
36	REC393831	393831	CARDAN (-OM400411)	SOCKET (-OM400411)	CARDAN (-OM400411)	CARDAN (-OM400411)
	REC865503T	865503T	CARDAN (OM400412+)	SOCKET FROM (OM4004112+) (GKN)	CARDAN (OM400412+)	CARDAN (OM400412+)
37	REC59830A7	59830A7	UNIÓN COLA (-OM400411)	YOKE ASSY. (-OM400411)	UNIONE PIEDE (-OM400411)	CARDAN (-OM400411)
	REC864281A2	865491A01 864281A01	UNIÓN COLA (OM400412+)	YOKE ASSY. (OM400412+) (GKN)	UNIONE PIEDE (OM400412+)	CARDAN (OM400412+)
38	REC25-25439	25-25439	ARO	O-RING	ANELLO	JOINT TORIQUE
	REC25-35027	25-35027	ARO	O-RING	ANELLO	JOINT TORIQUE
39	REC814819A7	814819A7	KIT TRANSMISIÓN (Gris)	U-JOINT ASSEMBLY (Grey)	KIT TRASMISSIONE (Grigio)	ARBRE TRANSMISSION (jaune)
	REC864281A2	86481A2	KIT TRANSMISIÓN GKN (Negro) (OL100009+)	U-JOINT ASSEMBLY GKN (BLACK) (OL100009+)	KIT TRASMISSIONE GKN (NERO) (OL100009+)	ARBRE TRANSMISSION (noir) (OL100009+)
40	REC26-88397A1	26-88397A1	KIT RETENES	GEARCASE SEAL KIT	KIT PARAOLIO	KIT JOINTS
41	REC27-94996Q2	27-94996Q2	KIT RETENES	GEARCASE SEAL KIT	KIT PARAOLIO	KIT JOINTS
	RECKITMALPHA2AL		KIT ÁNODOS AL	ANODE KIT AL	KIT ANODI AL	KIT ANODES AL
42	CMALPHAKITA		KIT ÁNODOS AL	ANODE KIT AL	KIT ANODI AL	KIT ANODES AL
	CMALPHAKITM		KIT ÁNODOS MG	ANODE KIT MG	KIT ANODI MG	KIT ANODES MG
	TENKITALPHAONE/2		KIT ÁNODOS ZN	ANODE KIT ZN	KIT ANODI ZN	KIT ANODES ZN
43	REC864281A2	864281A2	KIT TRANSMISION GNK (negro)	YOKE ASSEMBLY GNK (black)	GIUNTO CARDANICO GNK (nero)	CARDAN COMPLET (noir)

ALPHA ONE GEN II STD & COUNTER ROTATION

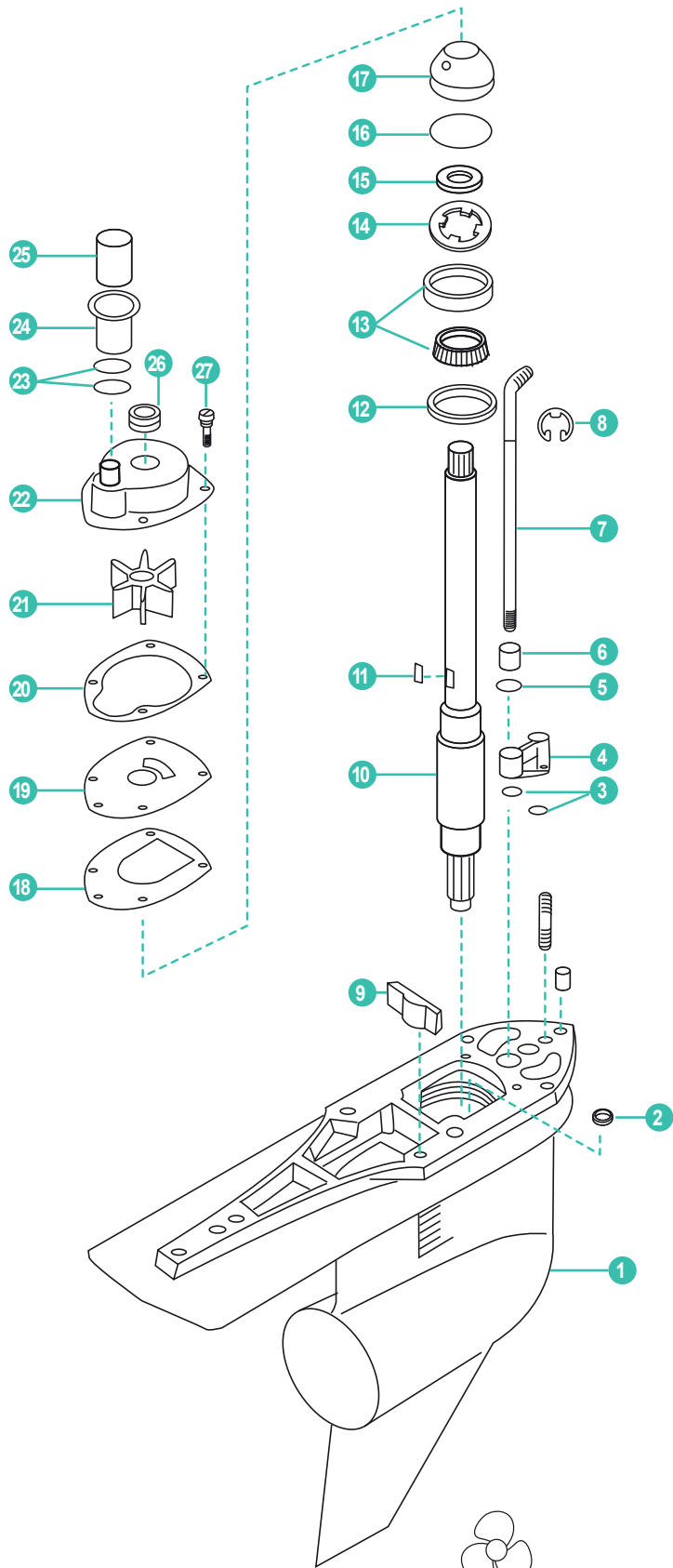



	REF	OEM				
1	REC1623-815822A30	1623-815822A30	CARCASA COLA (OD469859-999999)	HOUSING (OD469859-999999)	CARCASSA (OD469859-999999)	CARDAN (OD469859-999999)
2	REC26-455771	26-45577-1	RETÉN	SEAL	TENUTA	JOINT D'HUILE
3	REC25-36318	25-36318	ARO TÓRICO	O-RING	ANELLO	JOINT TORIQUE
4	REC23-815921A21	23-815921A21	CASQUILLO	SHIFT BUSHING	BOCCOLA	INSERT D'AXE
5	REC26-8164641	26-816464-1	RETÉN ACEITE	OIL SEAL	PARAOLIO	JOINT D'HUILE
6	REC23-67370	23-67370	LEVA	CAM	BOCCOLA	CAM
7	REC815919A1	815919A1	EJE CAMBIO	DRIVE SHAFT	ASSE	ARBRE CHANGEMENT
8	REC53-29641	53-29641	CIERRE	CIRCLIP	CIRCLIP	CLIPS
9	REC821526001	861526001	RETÉN DE GOMA	RUBBER SEAL	PARAOLIO IN GOMMA	JOINT CAOUTCHOUC
10	REC45-816919	45-816919	EJE TRANSMISIÓN (-999999)	SHAFT (-999999)	ASSE (-999999)	ARBRE TRANSMISSION (-999999)
	REC45-853648	45-853648	EJE TRANSMISIÓN (OL100040+)	SHAFT (OL100040+)	ASSE (OL100040+)	ARBRE TRANSMISSION (OL100040+)
11	REC28-8M0032833	28-8M0032833	CHAVETA	CLIP	CHIAVE	CLAVETTE
12	REC15-42637A1	15-42637A1	GRUESO	SHIM	SPESSORE	CALE
13	REC31-36387A1	31-36387A1	RODAMIENTO	BEARING	CUSCINETTO	ROULEMENT
	REC31-33138A1	31-33138A1	RODAMIENTO (1998+)	BEARING (1998+)	CUSCINETTO (1998+)	ROULEMENT (1998+)
14	REC8245191	8245191	RETENEDOR	SEAL	TENUTA	JOINT D'HUILE
15	REC26-66302	26-66302	RETÉN ACEITE (-0M400411)	OIL SEAL (-0M400411)	PARAOLIO (-0M400411)	JOINT D'HUILE (-0M400411)
	REC26-864319	26-864319	RETÉN ACEITE (0M400411+)	OIL SEAL (0M400411+)	PARAOLIO (0M400411+)	JOINT D'HUILE (0M400411+)
16	REC25-90011	25-90011	ARO TÓRICO	O-RING	ANELLO	JOINT TORIQUE
17	REC807929A1	807929A1	PORTA RETÉN (1991+)	SEAL BASE (1991+)	BASE TENUTA (1991+)	BASE DE POMPE A EAU (1991+)
18	REC27-430331	27-430331	JUNTA	GASKET	GUARNIZIONE	JOINT
19	REC8172761	8172761	TAPA BOMBA AGUA	PUMP CAP	COPERCHIO POMPA	COUVERCLE POMPE
20	REC27-8172771	27-8172771	JUNTA	GASKET	GUARNIZIONE	JOINT
21	REC47-43026Q02	47-43026Q02	IMPULSOR	IMPELLER	GIRANTE	TURBINE
22	RM817275A1	817275A1	TAPA BOMBA AGUA	CAP WATER PUMP	COPERCHIO POMPA ACQUA	COUVERCLE POMPE
23	REC25-21836	25-21836	ARO TÓRICO	O-RING	FASCE	JOINT TORIQUE
24	REC816597A1	816597A1	TUBO AGUA	TUBE	TUBO	DURITE À EAU
25	REC23-816583	23-816583	TUBO	TUBE	TUBO	TUYAU
26	REC26-816575A2	26-816575A2	RETÉN GOMA	SEAL	TENUTA	JOINT CAOUTCHOUC
27	REC10-816928	10-816928	TORNILLO	BOLT	VITE	VIS
28	REC26-816575A3	26-816575A3	KIT REPARACIÓN	REPAIR KIT	KIT RIPARAZIONE	KIT JOINT
29	RM23-815921A17	23-815921A17	CASQUILLO CORREDERA	BUSHING	GHIERA SCORREVOLE	BUSHING



REC80W90U3  
REC80W90U6  
RECGREU1  
RECGREU12

P  
25

ALPHA ONE GEN II STD & COUNTER ROTATION

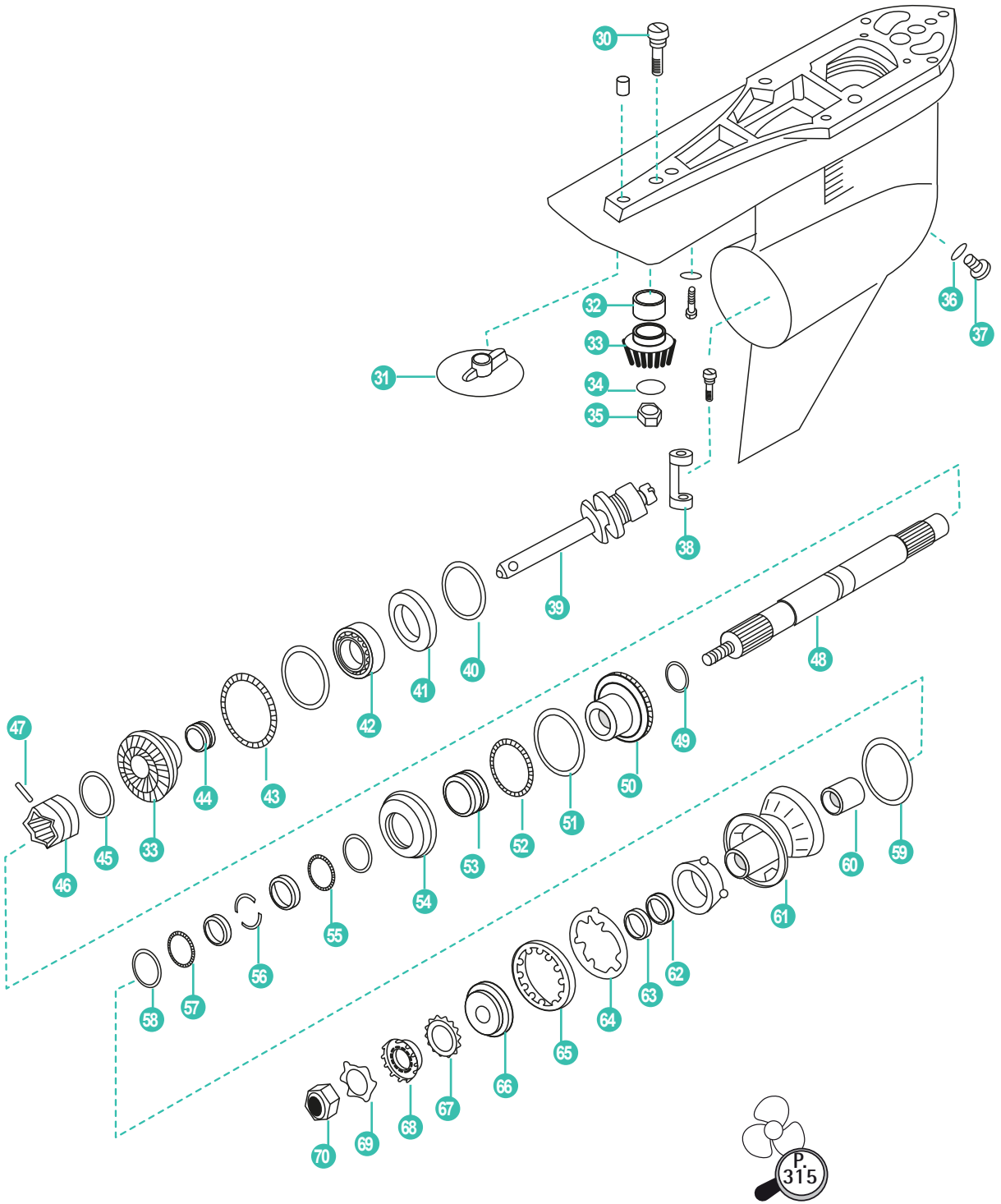

	REF	OEM				
30	REC10-806327	10-806327	TORNILLO	BOLT	VITE	VIS
31	CM762145	76214Q5	ÁNODO ZN	ANODE ZN	ANODO ZN	ANODE ZN
	CM762145A	76214Q5	ÁNODO AL	ANODE ALU	ANODO AL	ANODE AL
32	REC387817	31-42647A1	RODAMIENTO	BEARING	CUSCINETTO	ROULEMENT
33	REC43-878087A2	43-878087A2	KIT PIÑONES (1996+) 13:21 1.47, 1.62, 1.81, 1.94 Ratio 3.265 OD Avante	PINION SET(1996) 13:21 1.47, 1.62, 1.81, 1.94 Ratio 3.265 OD Forward bearing	KIT PIGNONE (1996) 13:21 1.47, 1.62, 1.81, 1.94 Rapporto 3.265 OD Avanti	KIT PIGNON (1996) 13:21 1.47, 1.62, 1.81, 1.94 Réd. 3.265 OD avant
	REC43-878617A2	43-853592A2	KIT PIÑONES (1998+) 2.00:1 / 2.40:1 3.265 OD Avante	PINION SET (1998+) 2.00:1 / 2.40:1 3.265 OD Forward bearing	KIT PIGNONE (1998+) 2.00:1 / 2.40:1 3.265 OD Avanti	KIT PIGNON (1998+) 2.00:1 / 2.40:1 3.265 OD avant
34	REC350038	12-92721	JUNTA	GASKET	GUARNIZIONE	JOINT
35	REC11-35921	11-35921	TUERCA	NUT	DADO	ÉCROU
36	REC12-191833	12-191833	JUNTA TAPÓN	CAP GASKET	GUARNIZIONE TAPPO	JOINT BOUCHON
37	REC22-67892A05	8M0058389	TAPÓN	CAP	TAPPO	BOUCHON
38	REC76865	76865	HORQUILLA CAMBIO	CLIP	CLIP	FOURCHETTE
39	REC818349T1	818349T1	EJE DESPLAZABLE	SHAFT	ASSE	SELECTEUR D'INVERSEUR
40	REC15-47397A1	15-47397A1	GRUESO (1991-95)	SHIM (1991-95)	SPESSORE (1991-95)	CALE (199-95)
	REC15-44491A1	15-44491A1	GRUESO (1996+)	SHIM (1996+)	SPESSORE (1996+)	CALE (1996+)
41	REC31-828437A2	31-828437A2	COJINETE Ø 44,45-88,9 mm	BEARING Ø 44,45-88,9 mm	CUSCINETTO Ø44,45-88,9 mm	ROULEMENT Ø44,45-88,9 mm
	REC31-35928T1	31-35928T1	COJINETE Ø 47,62-88,9 mm	BEARING Ø 47,62-88,9 mm	CUSCINETTO Ø 47,62-88,9 mm	ROULEMENT Ø 47,62-88,9 mm
42	REC31-30894A1	31-30894A1	COJINETE Ø 44,45-82,93 mm	BEARING Ø 44,45-82,93 mm	CUSCINETTO Ø 44,45-82,93 mm	ROULEMENT Ø 44,45-82,93 mm
	REC31-828439A2	31-828439A2	COJINETE Ø 47,62-82,93 mm	BEARING Ø 47,62-82,93 mm	CUSCINETTO Ø 47,62-82,93 mm	ROULEMENT Ø 47,62-82,93 mm
	REC828830A2	828830A2	COJINETE ADAPTADOR	BEARING ADAPTOR ASSY	CUSCINETTO ADATTATORE	ADAPTATEUR POUR ROULEMENT
42	REC31-814653T	31-814653	COJINETE	BEARING CARRIER	CUSCINETTO	ROULEMENT
43		31-815480	COJINETE ALPHA (1996+)	BEARING ALPHA (1996+)	CUSCINETTO ALPHA (1996+)	ROULEMENT ALPHA (1996+)
44	REC31-30895T	31-30895T	RODAMIENTO STD	BEARING STD	CUSCINETTO STD	ROULEMENT STD
	REC31-15844	31-15844	RODAMIENTO	BEARING	CUSCINETTO	ROULEMENT
45	REC24-30893	24-30893	MUELLE	SPRING	MOLLA	RESSORT
46	REC52-853594T	52-853594T	SELECTOR	GEAR	PIGNONE	CRABOT
47	REC17-8M0084681	8M0020941	PASADOR	PIN	SPINOTTO	GOUPILLE
	REC44-824110	44-824110	EJE HÉLICE (1991-97) (-999999)	SHAFT PROPELLER (1991-97) (-999999)	ASSE ELICA (1991-97) (-999999)	ARBRE HÉLICE (91-97) (-999999)
48	REC44-850308	44-850308	EJE HÉLICE (1998+) (OL100040+)	SHAFT PROPELLER (1998+) (OL100040+)	ASSE ELICA (1991-97) (OL100040+)	ARBRE HÉLICE (1991-97) (OL100040+)
	REC44-8146061	814606 1	EJE (1991-95)	PROPSHAFT (1991-95)	ASSE (1991-95)	ARBRE (1991-95)
49	REC23-824108	23-824108	SUPLEMENTO	SHIM	SPESSORE	CALE
50	REC43-828073A1	43-828073A1	PIÑÓN MARCHA ATRÁS	GEAR REVERSE	PIGNONE MARCIA INDIETRO	PIGNON MARCHE ARRIÈRE
51	REC681001	681001	ARO	RING	ANELLO	BAGUE
52	REC30-88957T	30-88957T1	RODAMIENTO	BEARING	CUSCINETTO	ROULEMENT
53	REC31-814653T	31-814653	ARANDELA	WASHER	RONDELLA	RONDELLE
54	REC814604T1	814604A1	RODAMIENTO	BEARING	CUSCINETTO	ROULEMENT
55	REC31-15842	31-15842	COJINETE RODILLOS	NEEDLE BEARING	CUSCINETTO	ROULEMENT
56	REC814605	814605	CIERRE	KEEPERS PROPSHAFT	CHIUSURA	CLIP
57	REC31-15842	31-15842	COJINETE RODILLOS	NEEDLE BEARING	CUSCINETTO	ROULEMENT
58	REC12-18448	12-18448	ARANDELA CIERRE	WASHER CLOSURE	RONDELLA CHIUSURA	RONDELLA
59	REC25-31534	25-31534	ARO TÓRICO	O-RING	FASCE	JOINT TORIQUE
60	REC387247	31-30956T	RODAMIENTO	BEARING	CUSCINETTO	ROULEMENT
61	REC818763A10	818763A10	COJINETE COLA STD	BEARING STD	CUSCINETTO STD	ROULEMENT
	REC14587A7	14587A5	COJINETE (1991-95)	BEARING CARRIER (1991-95)	CUSCINETTO(1991-95)	ROULEMENT (1991-95)
62	REC26-76868	26-14077	RETÉN ACEITE Interior	OIL SEAL Inside	PARAOLIO interno	JOINT D'HUILE intérieur
63	REC26-12224	26-12224	RETÉN ACEITE Extrior	OIL SEAL Outside	PARAOLIO esterno	JOINT D'HUILE extérieur
64	REC14-18323	14-18323	TAPA	CAP	COPERCHIO	COUVERCLE
65	REC8M2011027	8M2011027	TUERCA	NUT	DADO	ÉCROU
66	REC12-835467Q01	12-835467Q01	SEPARADOR	SPACER	DISTANZIALE	CALE
67	REC13-423511	13-423511	CIERRE	CLIP	CHIUSURA	CLIPS
68	REC12-31211Q03	12-31211A2	TOPE CIERRE HÉLICE	END CLIP	TAPPO CHIUSURA ELICA	RONDELLE FREIN DE DIABOLO
69	REC90508-ZW1-003	14-816629Q	CIERRE	CLIP	CHIUSURA	RONDELLE FREIN
70	REC90301-ZW1-003	11-827614	TUERCA	NUT	DADO	ÉCROU
71	REC11-52707Q1	11-52707Q1	KIT CIERRE HÉLICE	PROPELLER NUT KIT	KIT CHIUSURA ELICA	KIT ÉCROU D'HÉLICE
	RECKITMALPHA2AL		KIT ÁNODOS AL	ANODE KIT AL	KIT ANODI AL	KIT ANODES AL
72	CMALPHAKITA		KIT ÁNODOS AL	ANODE KIT AL	KIT ANODI AL	KIT ANODES AL
	CMALPHAKITM		KIT ÁNODOS MG	ANODE KIT MG	KIT ANODI MG	KIT ANODES MG
	TENKITALPHAONE/2		KIT ÁNODOS ZN	ANODE KIT ZN	KIT ANODI ZN	KIT ANODES ZN
73	CM806105	806105Q1	ÁNODO EJE HÉLICE ZN	PROP SHAFT ANODE ZN	ANODO ASSE ELICA ZN	ANODE ARBRE HÉLICE ZN
	CM806105A	806105Q1	ÁNODO EJE HÉLICE AL	PROP SHAFT ANODE AL	ANODO ASSE ELICA AL	ANODE ARBRE HÉLICE AL
74	REC43-878087A2	43-878087A2	KIT PIÑÓN RODAMIENTO (13:21)	PINION AND FORWARD GEAR SET. INCLUDES FORWARD BEARING	KIT PIGNONI (13:21) INCLUDE CUSCINETTO	KIT PIGNONE ROULEMENT (13:21)
			INCLUYE RODAMIENTO REC31-30894A1 (1996+)	REC31-30894A1 (1996+)	REC31-30894A1 (1996+)	COMPRIS LE ROULEMENT REC31-3089A1 (1996+)



CONTRAROTACIÓN  
ROTACIÓN ESTÁNDAR

COUNTER ROTATION  
STD ROTATION

CONTOROTRANTE  
ROTAZIONE STD

CONTRAROTATION  
ROTATION STD

BRAVO

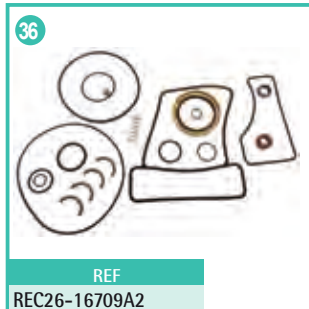
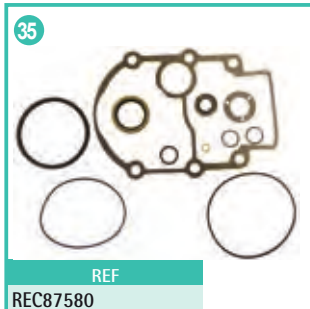
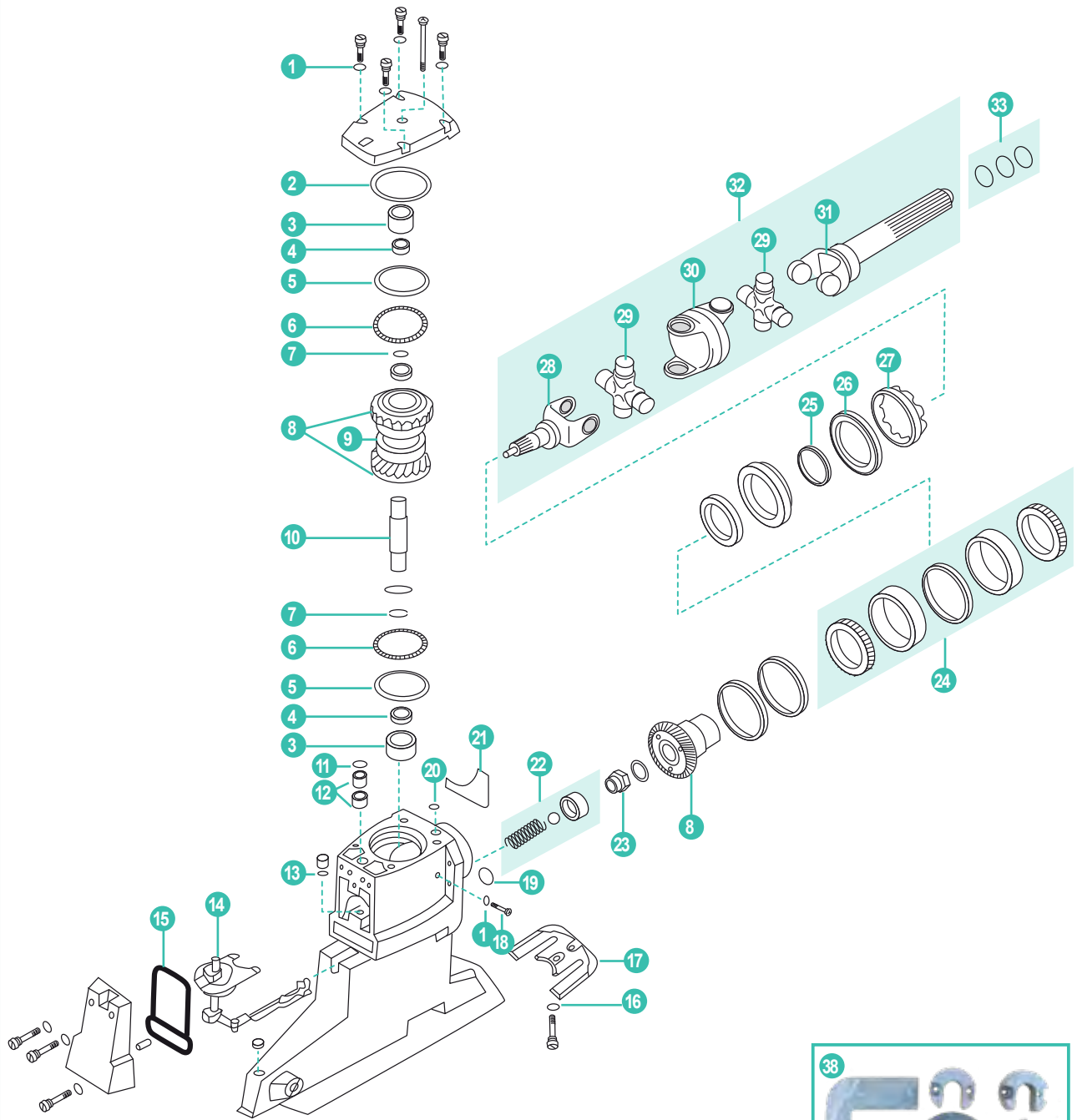



	REF	OEM				
1	REC12-191833	12-191833	JUNTA	GASKET	GUARNIZIONE	JOINT
2	REC25-97387	25-97387	ARO TÓRICO	O-RING	ANELLO	JOINT TORIQUE
3	REC31-815900	31-815900	COJINETE	BEARING	CUSCINETTO	ROULEMENT
4	REC31-87156	31-87156	COJINETE	BEARING	CUSCINETTO	ROULEMENT
	RM23-87560091	23-87560091	GRUESO .091 rojo	SHIM .091 red	SPESSORE .091 rosso	CALE .091 rouge
5	RM23-87560094	23-87560094	GRUESO .094 azul	SHIM .094 blue	SPESSORE .094 blu	CALE .094 bleu
	RM23-87560097	23-87560097	GRUESO .097 verd	SHIM .097 green	SPESSORE .097 verde	CALE .097 verd
6	REC31-86771	31-86771	COJINETE	BEARING	CUSCINETTO	ROULEMENT
7	RM97351	97351	RETENEDOR	RETAINER	TENUTA	JOINT D'HUILE
	RM43-887906A1	43-887906A1	KIT PIÑONES (29/27) BRAVO I. 1.36:1 BRAVO II. 1.50:1 & 1.81:1 BRAVO III. 1.36:1 & 1.81:1 KIT PINONES (32/27)	BEARING KIT (29/27) BRAVO I. 1.36:1 BRAVO II. 1.50:1 & 1.81:1 BRAVO III. 1.36:1 & 1.81:1 BEARING KIT (32/27)	KIT PIGNONE (29/27) BRAVO I. 1.36:1 BRAVO II. 1.50:1 & 1.81:1 BRAVO III. 1.36:1 & 1.81:1 KIT PIGNONE (32/27)	KIT PIGNONE (29/27) BRAVO I. 1.36:1 BRAVO II. 1.50:1 & 1.81:1 BRAVO III. 1.36:1 & 1.81:1 KIT PIGNONE (32/27)
8	RM43-887903A1	43-887903A1	BRAVO I. 1.50:1 BRAVO II. 1.65:1 & 2.00:1 BRAVO III. 1.65:1 & 2.00:1 KIT PINONES (30/23)	BRAVO I. 1.50:1 BRAVO II. 1.65:1 & 2.00:1 BRAVO III. 1.65:1 & 2.00:1 BEARING KIT (30/23)	BRAVO I. 1.50:1 BRAVO II. 1.65:1 & 2.00:1 BRAVO III. 1.65:1 & 2.00:1 KIT PIGNONE (30/23)	BRAVO I. 1.50:1 BRAVO II. 1.65:1 & 2.00:1 BRAVO III. 1.65:1 & 2.00:1 KIT PIGNONE (30/23)
	RM43-887909A1	43-887909A1	BRAVO I. 1.65:1 BRAVO II. 2.20:1 BRAVO III. 2.20:1 & 2.43:1	BRAVO I. 1.65:1 BRAVO II. 2.20:1 BRAVO III. 2.20:1 & 2.43:1	BRAVO I. 1.65:1 BRAVO II. 2.20:1 BRAVO III. 2.20:1 & 2.43:1	BRAVO I. 1.65:1 BRAVO II. 2.20:1 BRAVO III. 2.20:1 & 2.43:1
9	RM52-865344A01	52-865344A01	CURSOS	CLUTCH	CURSORE	CONE D'EMBRAYAGE
10	RM45-812773T	45-812773	EJE TRANSMISIÓN	DRIVE SHAFT	ASSE	ARBRE TRANSMISSION
11	REC25-62705	25-62705	ARO TÓRICO	O-RING	ANELLO	JOINT TORIQUE
12	REC23-861209A1	23-861209A1	RETÉN	RETAINER	TENUTA	JOINT D'HUILE
13	REC26-12709	26-12709	RETÉN ACEITE	OIL SEAL	PARAOLIO	JOINT D'HUILE
14	REC12711	12711	EJE SELECTOR	SHAFT	ASSE SELETTORE	ARBRE SUPERIEUR
15	REC12708	12708	RETÉN	RETAINER	TENUTA	JOINT
16	REC13-35048	13-35048	ARANDELA	WASHER	RONDELLA	RONDELLE
17	CM821630	821630Q1	ÁNODO ZN	ANODE ZN	ANODO ZN	ANODE ZN
	CM821630A	821630Q1	ÁNODO AL	ANODE AL	ANODO AL	ANODE AL
18	REC22-67892A05	8M0058389	TORNILLO	SCREW	VITE	VIS
19	REC25-457101	25-457101	ARO TÓRICO (1.424 x 103)	O-RING (1.424 x 103)	ANELLO (1.424 x 103)	JOINT TORIQUE (1.424 x 103)
20	REC25-62706	25-62706	ARO TÓRICO (.426 x 0.70)	O-RING (.426 x 0.70)	ANELLO (.426 x 0.70)	JOINT TORIQUE (.426 x 0.70)
21	REC86310	16755Q1	RETÉN	RETAINER	TENUTA	JOINT D'HUILE
22	REC24-17997A1	24-17997A1	JUEGO MUELLE	SPRING SET	KIT MOLLA	KIT RESSORT
23	REC11-22339	11-22339	TUERCA	NUT	DADO	ÉCROU
24	REC31-86763A2	31-86763A2	RODAMIENTO (- OM198372)	BEARING (-OM198372)	CUSCINETTO (-OM198372)	ROULEMENT (-OM198372)
	RM31-86763A04	31-86763A04	RODAMIENTO (OM198373+)	BEARING (OM198373+)	CUSCINETTO (-OM198373+)	ROULEMENT (-OM198373+)
25	REC26-807006	26-807006	RETÉN ACEITE Ø 2.254"	OIL SEAL Ø 2.254"	PARAOLIO Ø 2.254"	OINT D'HUILE Ø 2.254"
	REC26-43993	26-43993	RETÉN ACEITE Ø 2.132"	OIL SEAL Ø 2.132"	PARAOLIO Ø 2.132"	OINT D'HUILE Ø 2.132"
26	REC86779A1	86779A1	PORTA RETÉN	RING	ANELLO	BAGUE PORTE JOINT SPI
27	RM11-92004	11-92004	TUERCA	NUT	DADO	ÉCROU
28	REC12784	12784	UNIÓN COLA-CARDAN (OM111207-)	YOKE (OM111207-)	ASSE PIEDE-CARDANO (OM111207-)	CARDAN (OM111207-)
	REC3850812	75832	CRUCETA	U-JOINT	CROCETTA	CROISILLON POUR EMBASE
29	RM866136A01	866136A01	CRUCETA (OM750175+) GKN	U-JOINT (OM750175+) GKN	CROCETTA (OM750175+) GKN	CROISILLON (OM750175+) GKN
	REC862132T	862132T	CRUCETA BRAVO X, XR, XZ	U-JOINT BRAVO X, XR, XZ	CROCETTA BRAVO X, XR, XZ	CROISILLON BRAVO X, XR, XZ
	REC865496A02	865496A01	CRUCETA BRAVO (OM111208+)	U-JOINT BRAVO (OM111208+)	CROCETTA BRAVO (OM111208+)	CROISILLON BRAVO (OM111208+)
30	REC393831	393831	CARDÁN (-OM111207)	SOCKET (-OM111207)	CARDANO (-OM111207)	CARDAN (-OM111207)
31	REC59830A7	814819A3	UNIÓN COLA MOTOR	YOKE ASSY	ASSE PIEDE	CARDAN
32	REC864244A2	864244A2	KIT TRANSMISIÓN BRAVO (OB664190+) (1985-05)	U-JOINT ASSEMBLY BRAVO (OB664190+) (1985-05)	KIT TRASMISSIONE BRAVO (OB664190+) (1985-05)	KIT TRASMISSION BRAVO (OB664190+) (1985-05)
	RM865425A03	865425A03	KIT TRANSMISIÓN COLAS BRAVO X, XR, XZ	U-JOINT ASSEMBLY BRAVO X, XR, XZ	KIT TRASMISSIONE BRAVO X, XR, XZ	KIT TRANSMISSION BRAVO X, XR, XZ
33	REC25-29845	25-29845	ARO TÓRICO (.924 x 1.03)	O-RING (.924 x 1.03)	ANELLO (.924 x 1.03)	JOINT TORIQUE (.924 x 1.03)
	REC25-35027	25-35027	ARO TÓRICO (1.046)	O-RING (1.046)	ANELLO (1.046)	JOINT TORIQUE (1.046)
34	REC23-861209A1	23-861209A1	KIT RETENES	SHIFT SHAFT BUSING	KIT TENUTES	KIT JOINTS
35	REC87580		KIT REPARACIÓN TR, TRS	GEARCASE SEAL KIT TR, TRS	KIT RIPARAZIONE TR, TRS	KIT JOINTS TR, TRS
36	REC26-16709A2	26-16709A2	KIT REPARACIÓN BRAVO I, II, III	GEARCASE SEAL KIT BRAVO I, II, III	KIT RIPARAZIONE BRAVO I, II, III	KIT JOINTS BRAVO I, II, III
37	REC16755Q1	16755Q1	KIT RETENES	GEARCASE SEAL KIT	KIT TENUTE	KIT JOINTS
38	RECKITMBRAVO1AL		KIT ÁNODOS AL	ANODE KIT AL	KIT ANODI AL	KIT ANODES AL

BRAVO I

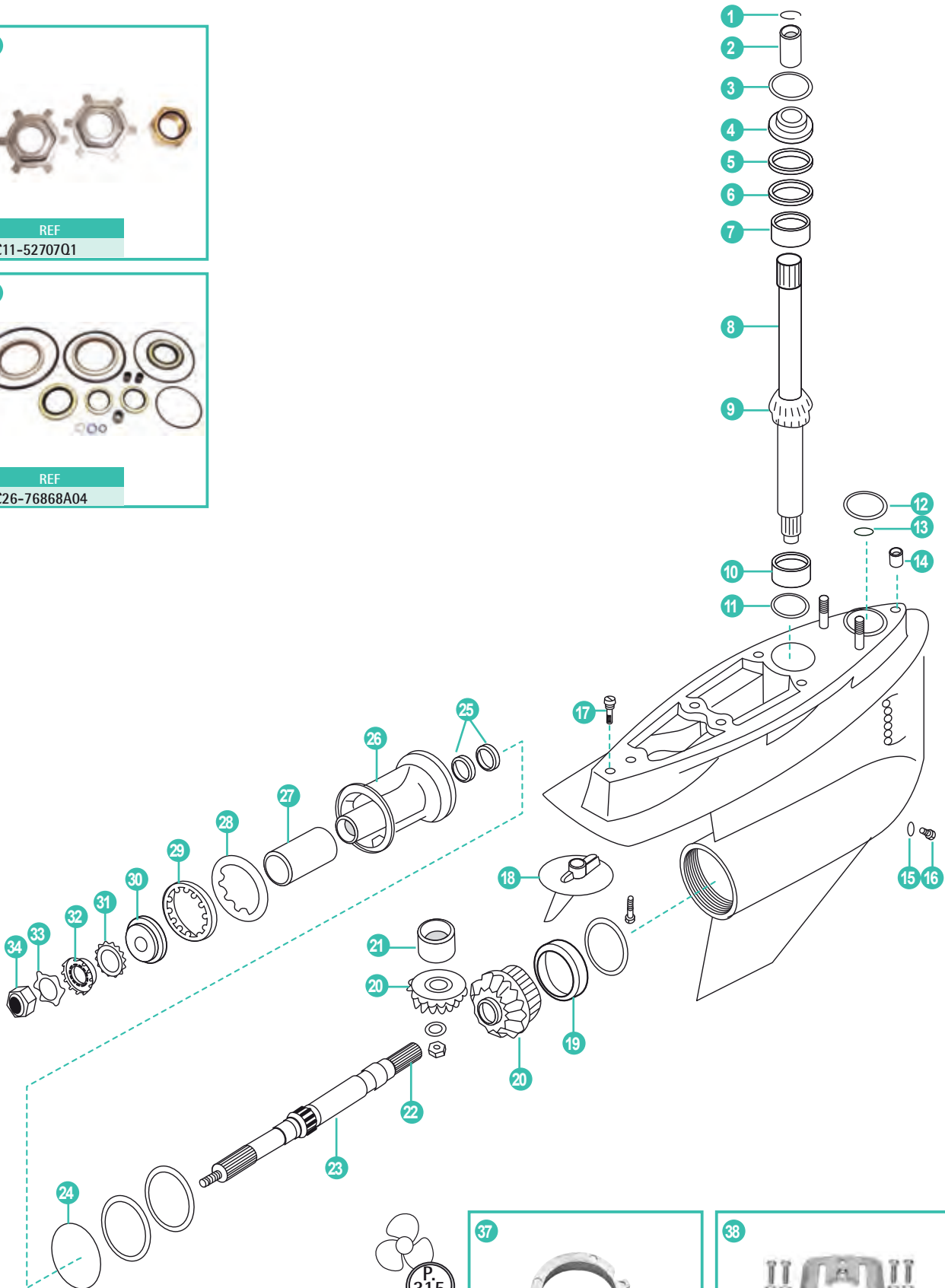

	REF	OEM				
	RM1656-8866A17	8866A64	CARCASA COLA (1656-8863CZ)	LOWER CASE (1656-8863CZ)	CARASSA PIEDE (1656-8863CZ)	CARTER PIED (1656-8863CZ)
1	REC53-88242	53-88242	CLIP	CLIP	CLIP	CLIPS
2	REC88243A3	88243A3	ACOPLE	COUPLING ASSEMBLY	ASSE ACCOPPIAMENTO	
3	REC308627	25-20826	ARO TÓRICO	O-RING	ANELLO	JOINT TORIQUE
4	REC23-8M8000506	23-92916	ESPACIADOR	SPACER	DISTANZIALE	CALE
5	REC15-86749A1	15-86749A1	KIT SUPLEMENTOS	SHIM KIT	KIT SPESSORE	KIT CALES
6	RM86739	14-86739	ARANDELA	WASHER	RONDELLA	RONDELLE
7	REC31-86748A1	31-86748A1	COJINETE	BEARING	CUSCINETTO	ROULEMENT
8	RM45-41629A2	41629A2	EJE TRANSMISIÓN	DRIVESHAFT	ASSE TRASMISSIONE	ARBRE TRANSMISSION
9	REC31-86748A1	31-86748A1	COJINETE	BEARING	CUSCINETTO	ROULEMENT
10	REC31-66668A1	66668A1 31-99328A1	COJINETE	BEARING	CUSCINETTO	ROULEMENT
11	REC15-92914A1	15-92914A1	KIT GRUESOS	SHIM KIT	KIT SPESSORE	KIT CALES
12	REC26-455771	26-455771	RETÉN	SEAL	TENUTA	JOINT D'HUILE
13	REC25-33465	25-33465 25-822370	ARO TÓRICO (2.362 x .103)	O-RING (2.362 x .103)	ANELLO (2.362 x .103)	JOINT TORIQUE (2.362 X .103)
14	REC26-36556	26-36556	TUBO AGUA Ø EXT. 12.7 mm	WATER TUBE Ø EXT. 12.7mm	TUBO ACQUA Ø EXT. 12.7 mm	DURITE Ø EXT. 12.7 mm
	REC26-805344	26-805344	TUBO AGUA Ø EXT. 15.88 mm	WATER TUBE Ø EXT. 15.88 mm	TUBO ACQUA Ø EXT. 15.88 mm	DURITE Ø EXT. 15.88 mm
15	REC12-191833	12-191833	JUNTA	GASKET	GUARNIZIONE	JOINT
16	REC22-67892A05	8M0058389	TORNILLO DRENAJE	DRAIN PLUG	VITE DRENAGGIO	VIS VIDANGE
17	REC10-806327	10-806327	TORNILLO	SCREW	VITE	VIS
18	CM762145	76214Q5	ÁNODO ZN	ZN ANODE	ANODO ZN	ANODE ZN
	CM762145A	76514Q5	ÁNODO AL	AL ANODE	ANODO AL	ANODE AL
19	REC31-86752A1	31-86752A1	COJINETE	BEARING	CUSCINETTO	ROULEMENT
20	RM43-14063A1	43-14063A1	KIT PIÑONES (15/19)	BEARING SET (15/19)	KIT CUSCINETTO (15/19)	KIT PIGNON (15/19)
21	REC31-86754T	31-86754T	COJINETE	BEARING	CUSCINETTO	ROULEMENT
22	RM44-41630T	44-850308 44-41630T	EJE HÉLICE	PROPSHAFT	ASSE ELICA	ARBRE HÉLICE
23	REC31-66668A1	66668A1 31-99328A1	COJINETE	BEARING	CUSCINETTO	ROULEMENT
24	REC25-31534	25-31534	ARO TÓRICO	O-RING	ANELLO	JOINT TORIQUE
25	REC26-76868	26-76868	RETÉN ACEITE	OIL SEAL	PARAOLIO	JOINT D'HUILE
26	REC41641A8	41641A8	COJINETE COLA	BEARING	CUSCINETTO	ROULEMENT EMBASE
27	REC31-54042T	31-54042T	COJINETE	BEARING	CUSCINETTO	ROULEMENT
28	REC14-18323	14-18323	ARANDELA	WASHER	RONDELLA	RONDELLE
29	REC8M2011027	8M2011027	TUERCA	NUT	DADO	ÉCROU
30	REC12-835467Q01	12-835467Q01	TOPE HÉLICE	SEPARATOR	FERMO PER ELICA	RONDELLE D'HÉLICE
31	REC13-423511	13-42351-1	CIERRE	LOCK	CHIUSURA	RONDELLE FREIN
32	REC12-31211Q03	12-31211Q03	TOPE CIERRE HÉLICE	WASHER	TAPPO CHIUSURA ELICA	RONDELLE FREIN DE DIABOLO
33	REC90508-ZW1-003	14-816629Q	ARANDELA CIERRE	LOCK WASHER	RONDELLA CHIUSURA	RONDELLE FREIN
34	REC90301-ZW1-003	11-827614	TUERCA CIERRE HÉLICE	LOCK NUT	DADO CHIUSURA	ECROU
35	REC11-52707Q1	11-52707Q1	KIT CIERRE HÉLICE	PROPELLER NUT KIT	KIT CHIUSSURA ELICHA	KIT ÉCROU D'HÉLICE
36	REC26-76868A04	26-76868A04	KIT REPARACIÓN BRAVO I, II, III	GEARCASE SEAL KIT BRAVO I, II, III	KIT RIPARAZIONE BRAVO I, II, III	KIT JOINTS BRAVO I, II, III
37	CM806188		ÁNODO ZN	ANODE ZN	ANODO ZN	ANODE ZN
	CM806188A		ÁNODO AL	ANODE AL	ANODO AL	ANODE AL
	RECKITMBRAVO1AL		KIT ÁNODOS AL	ANODE KIT AL	KIT ANODI AL	KIT ANODES AL
38	CMBRAVO1KITA		KIT ÁNODOS AL	ANODE KIT AL	KIT ANODI AL	KIT ANODES AL
	CMBRAVO1KITM		KIT ÁNODOS MG	ANODE KIT MG	KIT ANODI MG	KIT ANODES MG
	TENKITBRAVOI		KIT ÁNODOS ZN	ANODE KIT ZN	KIT ANODI ZN	KIT ANODES ZN



BRAVO II

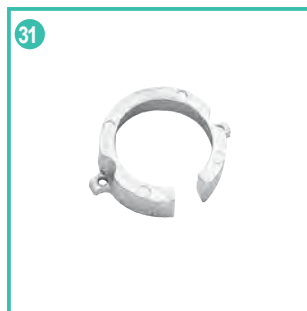
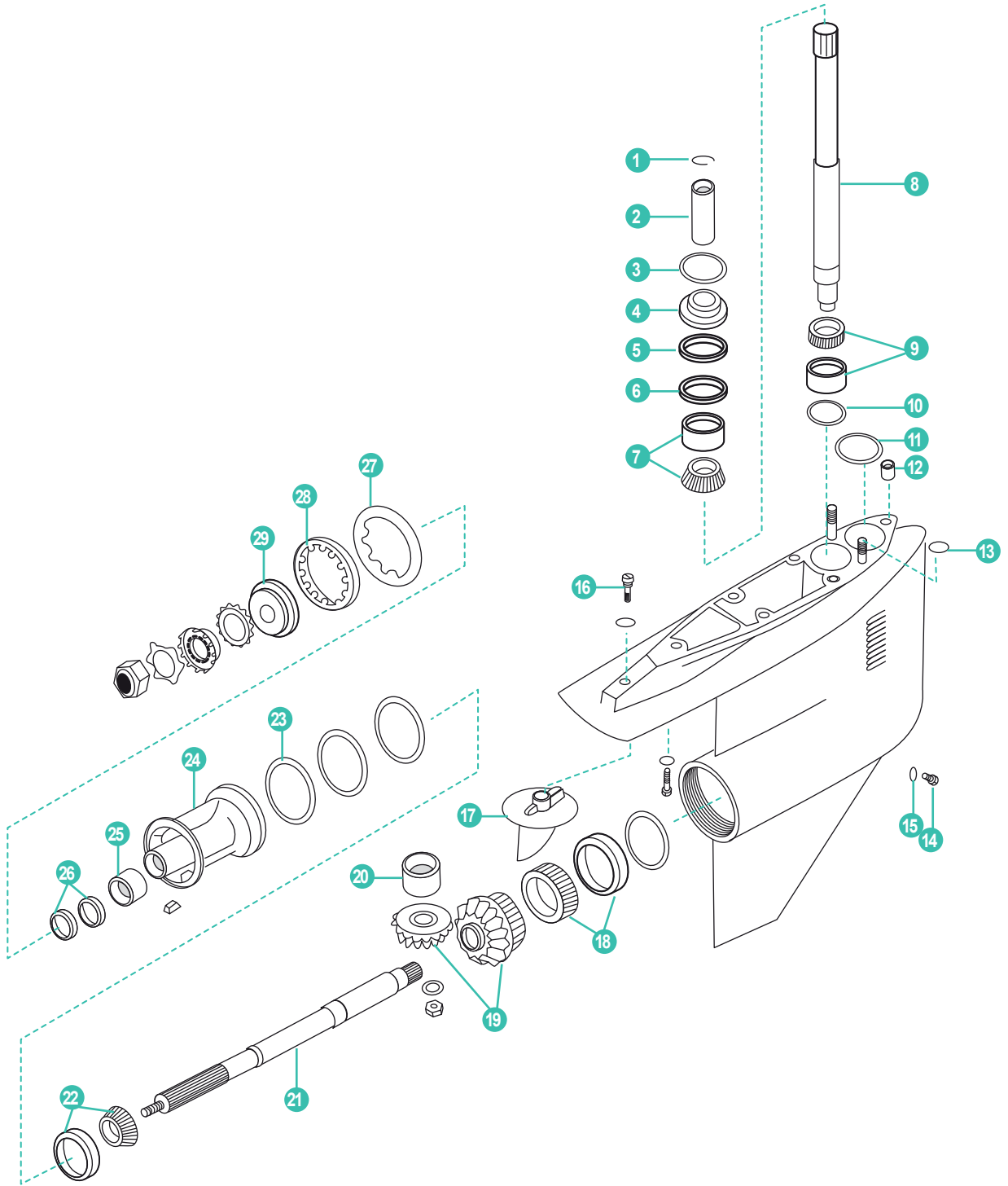



	REF	OEM				
1	REC53-88242	53-88242	CLIP	CLIP	CLIP	CLIPS
2	REC88243A3	88243A3	ACOPLE	COUPLING ASSEMBLY	ACCOPIAMENTO	ACCOUPEMENT
3	REC308627	25-20826	ARO TÓRICO	O-RING	ANELLO	JOINT TORIQUE
4	REC23-8M8000506	92916	ESPACIADOR	SPACER	DISTANZIALE	CALE
5	REC15-86749A1	15-86749A1	KIT GRUESOS	SHIM KIT	KIT SPESSORE	KIT CALES
6	RM86739	14-86739	ARANDELA	WASHER	RONDELLA	RONDELLE
7	REC31-86748A1	31-86748A1	COJINETE	BEARING	CUSCINETTO	ROULEMENT
8	RM45-41629A2	45-41629A2	EJE	DRIVESHAFT	ASSE	ARBRE
9	REC31-66668A1	31-66668A1	COJINETE	BEARING	CUSCINETTO	ROULEMENT
10	REC15-92914A1	15-92914A1	KIT GRUESOS	SHIM KIT	KIT SPESSORE	KIT CALES
11	REC25-33465	25-822370	ARO	O-RING	ANELLO	JOINT TORIQUE
12	REC26-805344	26-805344	RETÉN AGUA Ø15.88 mm	SPEEDOMETER SEA Ø15.88 mm	TENUTA ACQUA Ø15.88 mm	TUBE D'EAU Ø16 mm
	REC26-36556	26-36556	RETÉN AGUA Ø 12.7 mm	SPEEDO GROMMET Ø 12.7 mm	TENUTA ACQUA Ø 12.7 mm	TUBE D'EAU Ø12,7 mm
13	REC26-455771	26-455771	RETÉN	SEAL	PARAOLIO	JOINT D'HUILE
14	REC22-67892A05	22-67892	TORNILLO CON RETÉN CIERRE	DRAINING SCREW SET	VITE CON PARAOLIO CHIUSURA	BOUCHON DE VIDANGE MAGNETIQUE + JOINT
15	REC12-191833	12-191833	JUNTA	GASKET	GUARNIZIONE	JOINT
16	REC10-806327	10-806327	TORNILLO ANODO	ANODE SCREW	VITE ANODO	VIS ANODE
17	CM762144	76214A2	ÁNODO ZN	ANODE ZN	ANODO ZN	ANODE ZN
	CM762144A	76214A2	ÁNODO AL	ANODE AL	ANODO AL	ANODE ZN
18	REC31-86752A1	31-86752A1	COJINETE	BEARING	CUSCINETTO	ROULEMENT
19	RM43-14063A1	43-14063A1	KIT PIÑONES (15/19)	GEAR SET (15/19)	KIT PIGNONI (15/19)	KIT PIGNON (15/19)
20	REC31-86754T	31-86754T	COJINETE	BEARING	CUSCINETTO	ROULEMENT
21	RM44-41630T	44-41630T	EJE HÉLICE	PROP SHAFT	ASSE ELICA	ARBRE HÉLICE
22	REC31-66668A1	31-66668A1	COJINETE	BEARING	CUSCINETTO	ROULEMENT
23	REC25-31534	25-31534	TÓRICA	O-RING	TENUTA	JOINT TORIQUE
24	REC41641A8	41641A8	COJINETE COLA	BEARING CARRIER	CUSCINETTO PIEDE	ROULEMENT DIABOLO
25	REC31-54042T	31-54042T	COJINETE	BEARING	CUSCINETTO	ROULEMENT
26	REC26-76868	26-76868	RETÉN	SEAL	PARAOLIO	JOINT D'HUILE
27	REC14-18323	14-18323	ARANDELA	LOCK WASHER	RONDELLA	RONDELLE
28	REC8M2011027	79448	TUERCA CIERRE COLA	LOCK NUT	RONDELLA CHIUSURA PIEDE	ECROU A CRENAUX
29	REC12-835467Q01	13171	TOPE HÉLICE	SEPARATOR	FERMO PER ELICA	RONDELLE D'HÉLICE
30	REC26-76868A04	26-76868A04	KIT REPARACIÓN BRAVO I, II, III	GEARCASE SEAL KIT BRAVO I, II, III	KIT RIPARAZIONE BRAVO I, II, III	KIT JOINTS BRAVO I, II, III
31	CM806188		ÁNODO ZN	ANODE ZN	ANODO ZN	ANODE ZN
	CM806188A		ÁNODO AL	ANODE AL	ANODO AL	ANODE AL
	RECKITMBRAVO23AL		KIT ÁNODOS AL	ANODE KIT AL	KIT ANODI AL	KIT ANODES AL
32	CMBRAVO2Y3KITA		KIT ÁNODOS AL	ANODE KIT AL	KIT ANODI AL	KIT ANODES AL
	CMBRAVO2Y3KITM		KIT ÁNODOS MG	ANODE KIT MG	KIT ANODI MG	KIT ANODES MG
	TENKITBRAVOII-III		KIT ÁNODOS ZN	ANODE KIT ZN	KIT ANODI ZN	KIT ANODES ZN



BRAVO III

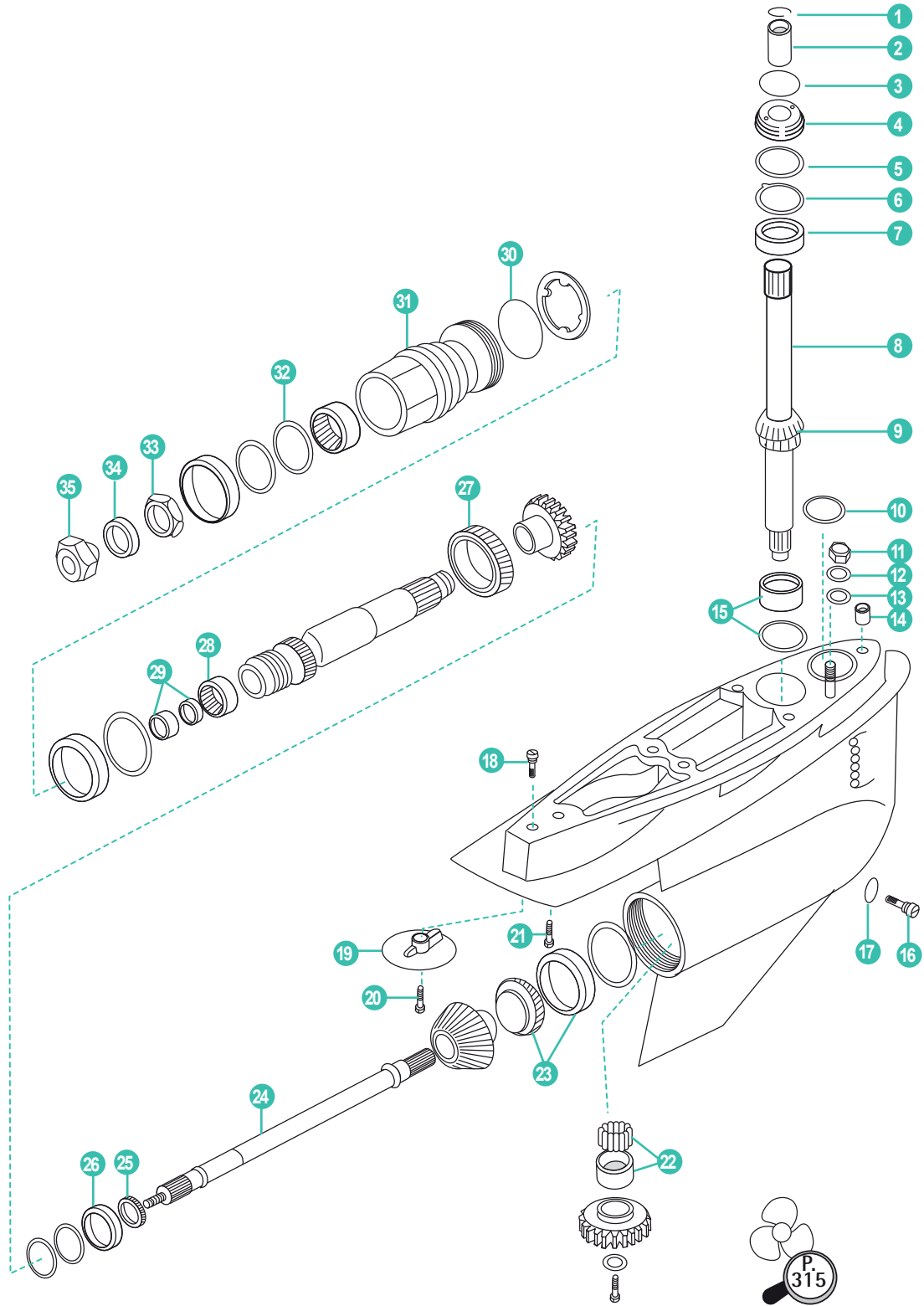

	REF	OEM				
1	REC53-88242	53-88242	RETÉN	SEAL	TENUTA	JOINT D'HUILE
2	REC88243A3	88243A3	ACOPLE	COUPLING	ACCOPIAMENTO	ACCOUPEMENT
3	REC308627	25-20826	ARO TÓRICO	O-RING	ANELLO	JOIN TORIQUE
4	REC23-8M8000506	23-92916	ESPACIADOR	SPACER	DISTANZIALE	CALE
5	REC15-86749A1	15-86749A1	KIT SUPLEMENTOS	SHIM KIT	SPESSORE KIT	KIT CALES
6	RM86739	86739	ARANDELA	WASHER	RONDELLA	RONDELLE
7	REC31-86748A1	31-86748A1	COJINETE	BEARING	CUSCINETTO	ROULEMENT
8	RM45-41629A2	805370A1	EJE (16.085 largo)	DRIVESHAFT (16.085 long)	ASSE (16.085 lungo)	ARBRE (16.085 large)
9	REC31-86748A1	31-86748A1	COJINETE	BEARING	CUSCINETTO	ROULEMENT
10	REC25-33465	25-33465	ARO TÓRICO	O-RING	ANELLO	JOINT TORIQUE
11	REC11-34933	11-859116	TUERCA	NUT	DADO	ÉCROU
12	REC12-45176	12-45176	ARANDELA	WASHER	RONDELLA	RONDELLE
13	REC26-455771	26-45577-1	RETÉN	SEAL	TENUTA	JOINT SPI
14	REC26-805344	26-805344	RETÉN	SEAL	TENUTA	JOINT SPI
15	REC31-66668A1	31-99328A1	COJINETE	BEARING	CUSCINETTO	ROULEMENT
16	REC22-67892A05	22-8M0058389	TORNILLO CON RETÉN	DRAININ SCREW SET	VITE CON TENUTA	VIS AVEC JOINT
17	REC12-191833	12-19183-3	JUNTA	GASKET	GUARNIZIONE	JOINT
18	REC10-806327	10-806327	TORNILLO	SCREW	VITE	VIS
19	CM762144	76214Q5	ÁNODO	ANODE	ANODO	ANODE
	CM762144A	76214Q5	ÁNODO ALDESIGN II	AL ANODE DESIGN II	ANODO AL DESIGN II	ANODE AL DESIGN II
20	REC313715	10-865321	TORNILLO	SCREW	VITE	VIS
21	REC10-816601	10-816601	TORNILLO	SCREW	VITE	VIS
22	RM86754T	86754T	COJINETE	BEARING	CUSCINETTO	ROULEMENT
23	REC31-86752A1	31-86752A1	COJINETE	BEARING	CUSCINETTO	ROULEMENT
24	RM44-865322T	44-865322T	EJE	SHAFT	ASSE	ARBRE
25	RM805322	805322	COJINETE	BEARING	CUSCINETTO	ROULEMENT
26	REC805100	805100	SEPARADOR	THRUST WASHER	SEPARATORE	RONDELLE DE BUTEE
27	RM805182A1	805182A1	COJINETE	BEARING	CUSCINETTO	ROULEMENT
28	RM57410	57410	COJINETE	BEARING	CUSCINETTO	ROULEMENT
29	REC26-8M0033407	26-8M0033407	RETÉN ACEITE	OIL SEAL	PARAOLIO	JOINT D'HUILE
30	REC3852865	25-805331	ARO TÓRICO	O-RING	ANELLO	JOINT TORIQUE
31	REC865876A01	865876A01	DIÁBOLO COMPLETO	CARRIER ASSY	COPERCHIO CUSCINETTO COMPLETO	DIABOLO COMPLET
32	REC26-861694	26-861694	RETÉN ACEITE	OIL SEAL	PARAOLIO	JOINT D'HUILE
33	REC11-8M0105210	11-8M0105210	TUERCA	NUT	DADO	ÉCROU
34	REC805101T	805101T	SEPARADOR	THRUST WASHER	SEPARATORE	RONDELLE DE BUTEE
35	REC11-862907	11-862907	TUERCA	NUT	DADO	ÉCROU
36	REC26-76868A04	26-76868A04	KIT REPARACIÓN BRAVO I, II, III	GEARCASE SEAL KIT BRAVO I, II, III	KIT RIPARAZIONE BRAVO I, II, III	KIT JOINTS BRAVO I, II, III
37	CMPNDAF14UNS		KIT ÁNODOS ZN	ANODE KIT ZN	KIT ANODI ZN	KIT ANODES ZN
	CMPNDAF14UNSA		KIT ÁNODOS AL	ANODE KIT AL	KIT ANODI AL	KIT ANODES AL
38	CM806188		ÁNODO ZN	ANODE ZN	ANODO ZN	ANODE ZN
	CM806188A		ÁNODO AL	ANODE AL	ANODO AL	ANODE AL
	RECKITMBRAVO3AL		KIT ÁNODOS AL	ANODE KIT AL	KIT ANODI AL	KIT ANODES AL
39	CMBRAVO3KITA		KIT ÁNODOS AL	ANODE KIT AL	KIT ANODI AL	KIT ANODES AL
	CMBRAVO3KITM		KIT ÁNODOS MG	ANODE KIT MG	KIT ANODI MG	KIT ANODES MG
	TENKITBRAVOIII-04		KIT ÁNODOS ZN	ANODE KIT ZN	KIT ANODI ZN	KIT ANODES ZN



REC80W90U3  
REC80W90U6  
RECGREU1  
RECGREU12

P  
25

ÁNODO

ANODE



ANODI

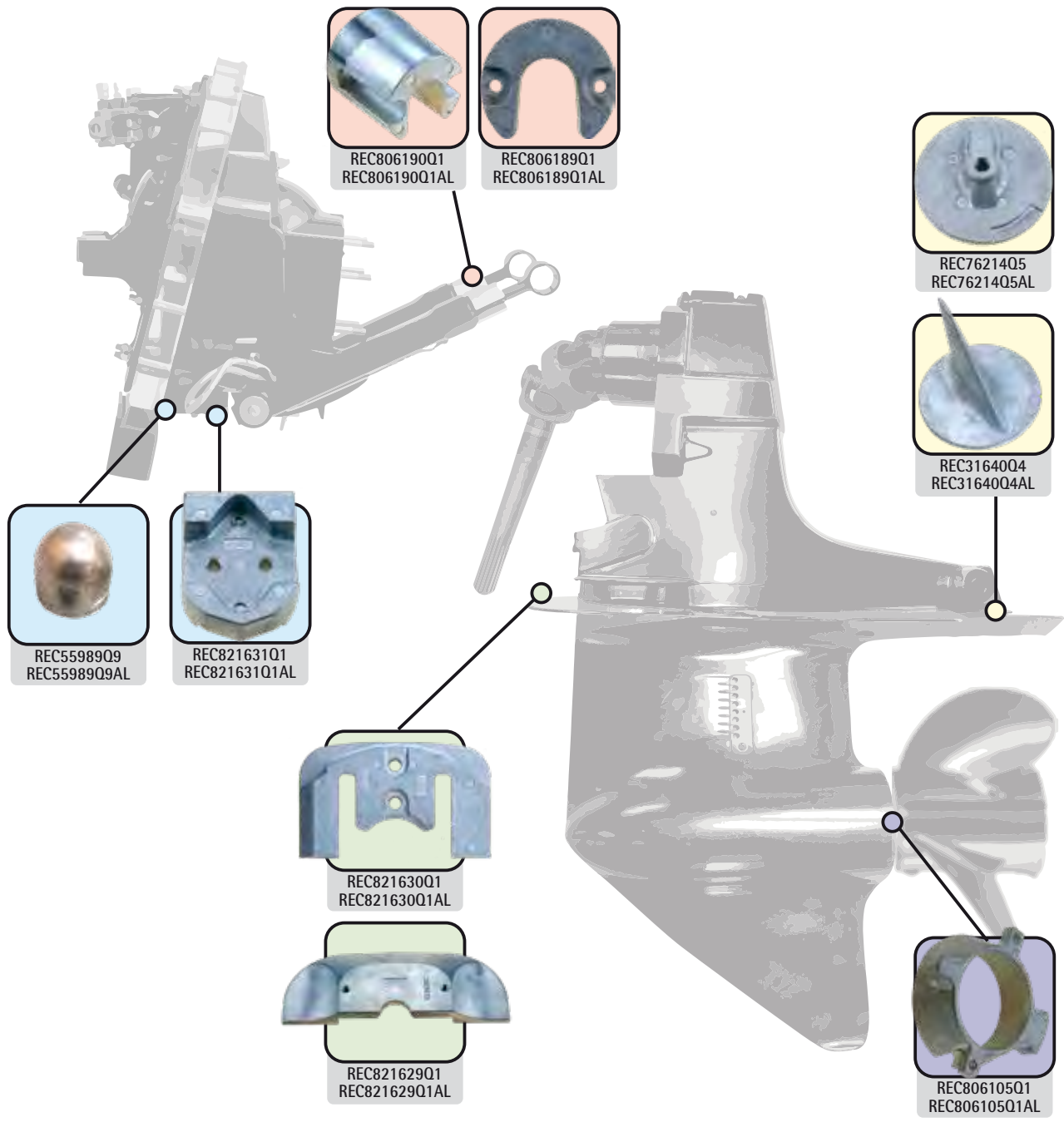

ANODE





	PLACA PLATE PIASTRA PLAQUE	TRANSOM	PISTÓN PISTON PISTONE PISTON	HÉLICE PROPELLER ELICA HELICE	TRIM TAB	KITS
BRAVO I	REC821630Q1 REC821630Q1AL		REC806190Q1 REC806190Q1AL		REC76214Q5 REC76214Q5AL	RECKITMBRAVO1ZN RECKITMBRAVO1M RECKITMBRAVO1AL RECKITMBRAVO23ZN RECKITMBRAVO23M RECKITMBRAVO23AL RECKITMBRAVO3M RECKITMBRAVO3AL
BRAVO II	REC821630Q1 REC821630Q1AL		REC806190Q1 REC806190Q1AL		REC76214Q5 REC76214Q5AL	RECKITMBRAVO1M RECKITMBRAVO1AL RECKITMBRAVO23ZN RECKITMBRAVO23M RECKITMBRAVO23AL RECKITMBRAVO3M RECKITMBRAVO3AL
BRAVO III	REC821630Q1 REC821630Q1AL		REC806190Q1 REC806190Q1AL		REC76214Q5 REC76214Q5AL	RECKITMBRAVO1M RECKITMBRAVO1AL RECKITMBRAVO23ZN RECKITMBRAVO23M RECKITMBRAVO23AL RECKITMBRAVO3M RECKITMBRAVO3AL
ALPHA ONE		REC821631Q1 REC821631Q1AL	REC806189Q1 REC806189Q1AL		REC31640Q4 REC31640Q4AL	RECKITMALPHA1ZN RECKITMALPHA1M RECKITMALPHA1AL RECKITMALPHA2ZN RECKITMALPHA2M RECKITMALPHA2AL
ALPHA ONE II GEN	REC821629Q1 REC821629Q1AL	REC821631Q1 REC821631Q1AL	REC806189Q1 REC806189Q1AL	REC806105Q1 REC806105Q1AL	REC76214Q5 REC76214Q5AL	RECKITMALPHA1M RECKITMALPHA1AL RECKITMALPHA2ZN RECKITMALPHA2M RECKITMALPHA2AL







		OEM	
	(kg)		
ZN REC821630Q1	0,98	821630Q1	
AL REC821630Q1AL			



		OEM	
	(kg)		
ZN REC821631Q1		821631Q1	
AL REC821631Q1AL			



		OEM	
	(kg)		
ZN REC821629Q1	0,70	821629Q1	
AL REC821629Q1AL			



		OEM	
	(kg)		
ZN REC806190Q1	0,34	806190Q1	
AL REC806190Q1AL			



		OEM	
	(kg)		
ZN REC806189Q1	0,12	806189Q1	
AL REC806189Q1AL			



		OEM	
	(kg)		
ZN REC76214Q5	0,34	76214Q5	
AL REC76214Q5AL			



		OEM	
	(kg)		
ZN REC31640Q4		31640Q4	
AL REC31640Q4AL			



		OEM	
	(kg)		
ZN REC806105Q1	0,23	806105Q1	
AL REC806105Q1AL			



		OEM	
	(kg)		
ZN REC55989Q9			
AL REC55989Q9AL		55989Q9	
MG REC55989Q9M			



	REF	OEM			
			(kg)		
ZN REC34127T2		34127	0,60	80 - 140 HP	
AL REC34127T2AL					

	REF	OEM			
			(kg)		
ZN REC94286T1		94286	0,27	25 HP	
AL REC94286T1AL					



	REF	OEM			
			(kg)		
ZN REC47820A1		47820	0,31	20 HP	
AL REC47820A1AL					



	REF	OEM			
			(kg)		
ZN REC46399		46399	0,40	50 - 140 HP	
AL REC46399AL					

	REF	OEM			
			(kg)		
ZN REC806188Q01		806188	0,17	BRAVO I, III	
AL REC806188Q01AL					

	REF	OEM			
			(kg)		
ZN REC762144		76214-4	0,26		
AL REC762144AL					

	REF	OEM			
			(kg)		
ZN REC7614T1		76214	0,31	VERADO - BRAVO	
AL REC7614T1AL					

	REF	OEM			
			(kg)		
ZN REC865182Q01		865182	0,52	BRAVO III	
AL REC865182Q01AL					



	REF	OEM			
			(kg)		
ZN REC43994A2		43994	0,90	ALPHA GEN II BRAVO	
AL REC43994A2AL					

KITS ANODOS			ANODES KIT	KIT ANODI	KIT ANODES
REF	OEM				
ZN RECKITMALPHA1ZN			RECKITMALPHA1ZN RECKITMALPHA1AL RECKITMALPHA1M	RECKITMALPHA1ZN RECKITMALPHA1AL RECKITMALPHA1M	RECKITMALPHA2AL RECKITMALPHA2AL RECKITMALPHA2M
AL RECKITMALPHA1AL	888756Q04	ALPHA 1			
MG RECKITMALPHA1M					
ZN RECKITMALPHA2ZN					
AL RECKITMALPHA2AL	888756Q03	ALPHA 2			
MG RECKITMALPHA2M					



KITS ANODOS			ANODES KIT	KIT ANODI	KIT ANODES
REF	OEM				
ZN RECKITMBRAVO1ZN			RECKITMBRAVO1ZN RECKITMBRAVO1AL RECKITMBRAVO1M	RECKITMBRAVO3ZN RECKITMBRAVO3AL RECKITMBRAVO3M	RECKITMBRAVO23ZN RECKITMBRAVO23AL RECKITMBRAVO23M
AL RECKITMBRAVO1AL	888758Q02	BRAVO 1			
MG RECKITMBRAVO1M					
ZN RECKITMBRAVO23ZN					
AL RECKITMBRAVO23AL	888761Q03	BRAVO 2			
MG RECKITMBRAVO23M					
ZN RECKITMBRAVO3ZN					
AL RECKITMBRAVO3AL	888761Q04	BRAVO 3			
MG RECKITMBRAVO3M					





ÁNODO		ANODE	ANODI	ANODE
REF	OEM			
ZN TEN00800	1301339	0,48 (kg)	50 HP	
REF	OEM			
ZN TEN00807	55989	0,10 (kg)	ALPHA ONE BRAVO I	
REF	OEM			
ZN TEN00814	821629	0,70 (kg)	ALPHA ONE ALPHA GEN II	
REF	OEM			
ZN TEN00815	821630	0,98 (kg)	BRAVO I, II, III	
REF	OEM			
ZN TEN00806BIS	821521	0,89 (kg)		
REF	OEM			
ZN TEN00820	76214-5	0,34 (kg)	ALPHA	
REF	OEM			
ZN TEN00823	823912	0,01 (kg)	Ø 20 (mm)	
ZN TEN00824	823913	0,02 (kg)	Ø 24 (mm)	

REF	OEM	 (kg)	
ZN TEN00819	806105	0,23	PISTON ALPHA ONE ALPHA GEN II



REF	OEM	 (kg)	
ZN TEN00818	806190	0,34	PISTON BRAVO



REF	OEM	 (kg)	
ZN TEN00839	853762	0,15	



REF	OEM	 (kg)	
ZN TEN00817	806189	0,12	PISTON ALPHA



**KITS DE ÁNODOS**



**ANODES KIT**

**KIT ANODI**



**KIT ANODES**

REF	OEM	 (kg)	
ZN TENKITALPHAONE/1	8887562Q02	1,83	MR, ALPHA ONE (1984-1990)





REF	OEM	 (kg)	
ZN TENKITALPHAONE/2	888756Q01 888756Q03	2,52	ALPHA ONE GEN II





REF	OEM	 (kg)	
ZN TENKITBRAVOI	888758Q01	2,34	BRAVO I







REF	OEM	 (kg)	
ZN TENKITBRAVOII-III	888761Q01	2,13	BRAVOII & III





REF	OEM	 (kg)	
ZN TENKITBRAVOIII-04	888761Q02	3	BRAVOIII (2004+)

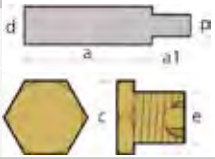

**CUMMINS**

KIT			a (mm)	a1 (mm)	d (mm)	p (mm)	c (mm)	e (mm)		
TEN02040			65	15	18	16 x 1,5				
TEN02041			31	13	16	3/8"				
ZN TEN02042			20	8	10	M6				
TEN02043T	TEN02043		50	10	16	15,5	22	1/2" gas		
TEN02044T	TEN02044	TEN02044TP	50	10	16	7/16"	22	1/2" gas		

REF	OEM	 (kg)	(mm)	
ZN TEN01320T	97-8M0151541 879194217 8M0067625 8M0067062 8M0150234 811487		20 x Ø ext. 15 M18x1.5	QSD 2.0/2.8/4.2



new



# ÁNODO

# ANODE

# ANODI

# ANODE

REF	OEM	(kg)	
ZN CMX-1	85538	0,136	ALPHA I
AL CMX-1A	823341	0,13	



REF	OEM	(kg)	
ZN CM806105	806188A1	0,23	ALPHA ONE, GEN II
AL CM806105A		0,09	



REF	OEM	(kg)	
ZN CM762144	76214-4	0,31	BRAVO III (2003+)
AL CM762144A		0,13	



REF	OEM	(kg)	
ZN CM55989	55989A9	0,11	ALPHA ONE, GEN II
AL CM55989A	55989Q9	0,09	



REF	OEM	(kg)	
ZN CM762145	76214A2	0,33	ALPHA ONE GEN II BRAVO III (-2003)
AL CM762145A	76214Q5	0,13	



REF	OEM	(kg)	
ZN CM821629	821629Q1	0,78	ALPHA ONE, GEN II
AL CM821629A		0,30	



REF	OEM	(kg)	
ZN CM76214Q5	76214Q5	0,33	BRAVO 4 225-250 HP



REF	OEM	(kg)	
ZN CM34762	34762A1	0,24	
AL CM34762A		0,09	



REF	OEM	(kg)	
ZN CM31640	31640A4	0,55	ALPHA ONE
AL CM31640A		0,13	



REF	OEM	(kg)	
ZN CM806188	806188A1	0,15	BRAVO
AL CM806188A		0,06	



REF	OEM	(kg)	
ZN CM46399	46399A1	0,36	ALPHA ONE GEN II
AL CM46399A	82277Q1	0,14	



REF	OEM	(kg)	
ZN CM821630	821630A1/Q1	1,00	BRAVO
AL CM821630A		0,39	



REF	OEM	(kg)	
ZN CM34127	34127T2	0,59	
AL CM34127A		0,22	



REF	OEM	(kg)	
ZN CM43994	43994A2 821631A1	0,95	Antiguos old vecchio Anciennes



REF	OEM	(kg)	
ZN CM806189	806189Q1	0,10	GEN II
AL CM806189A		0,04	



REF	OEM	(kg)	
ZN CM821631	43994A2 821631A1	0,89	Modernos New style
AL CM821631A		0,35	Moderno Nouveaux



REF	OEM	(kg)	
ZN CM806190	806190Q1	0,35	BRAVO
AL CM806190A		0,14	







### KITS DE ÁNODOS

### ANODES KIT

### KIT ANODI

### KIT ANODES

REF	ANODO ANODE	(kg)	
ZN CMCC	CMC	0,93	ALPHA I , MR

REF	OEM	(kg)	
ZN CMPNCZF16Z		0,93	ALPHA I , BRAVO I
AL CMPNCF16A		0,54	

REF	OEM	(kg)	
ZN			BRAVO II
AL CMPNEZF14A		0,65	

REF	OEM	(kg)	
ZN CMPNDAF14UNSA		0,93	BRAVO III (-2003)
AL CMPNDAF14UNSA		0,54	

REF	(kg)	TIPO TYPE TIPO TIPO	
ZN CMPNAZ	0,09	A	BRAVO
AL CMPNAA	0,03		
ZN CMPNBZ	0,23	B	BRAVO
AL CMPNBA	0,09		
ZN CMC	0,45	C	BRAVO
AL CMPNCA	0,19		
ZN CMPNDZ	0,68	C	BRAVO
AL CMPNDA	0,29		

REF	OEM	(kg)	
ZN CM865182CZ		0,51	BRAVO III (2004+)
AL CM865182CA		0,42	

REF	OEM	
MG CMBRAVO3KITM	888761Q02	BRAVO III (2004+)
AL CMBRAVO3KITA		

REF	OEM	
MG CMALPHAGEN1KITM	888756Q02	MR, ALPHA ONE (1984-90)
AL CMALPHAGEN1KITA		

REF	OEM	
MG CMALPHAKITM	888756Q01	ALPHA ONE
AL CMALPHAKITA	888756Q03	GEN II

REF	OEM	
MG CMBRAVO1KITM	888758Q01	BRAVO I
AL CMBRAVO1KITA		

REF	OEM	
MG CMBRAVO2Y3KITM	888761Q01	BRAVO II BRAVO III
AL CMBRAVO2Y3KITA		

# TRANSOM

**KITS DE TRANSOM Y PISTON DIRECCION ALPHA ONE GEN I & II**

**GIMBAL HOUSING & POWER STEERING CYLINDER KIT ALPHA ONE GEN I & II**

**TRANSOM E PISTONE STERZO ALPHA ONE GEN I & II**

**KIT TRANSOM ET PISTON DE DIRECTION ALPHA ONE GEN I & II**

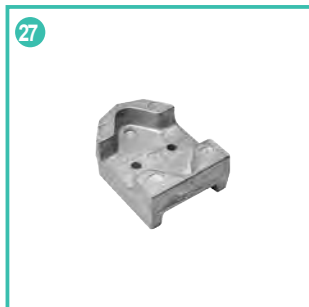
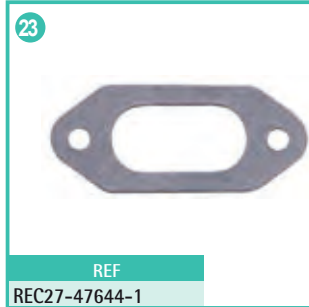
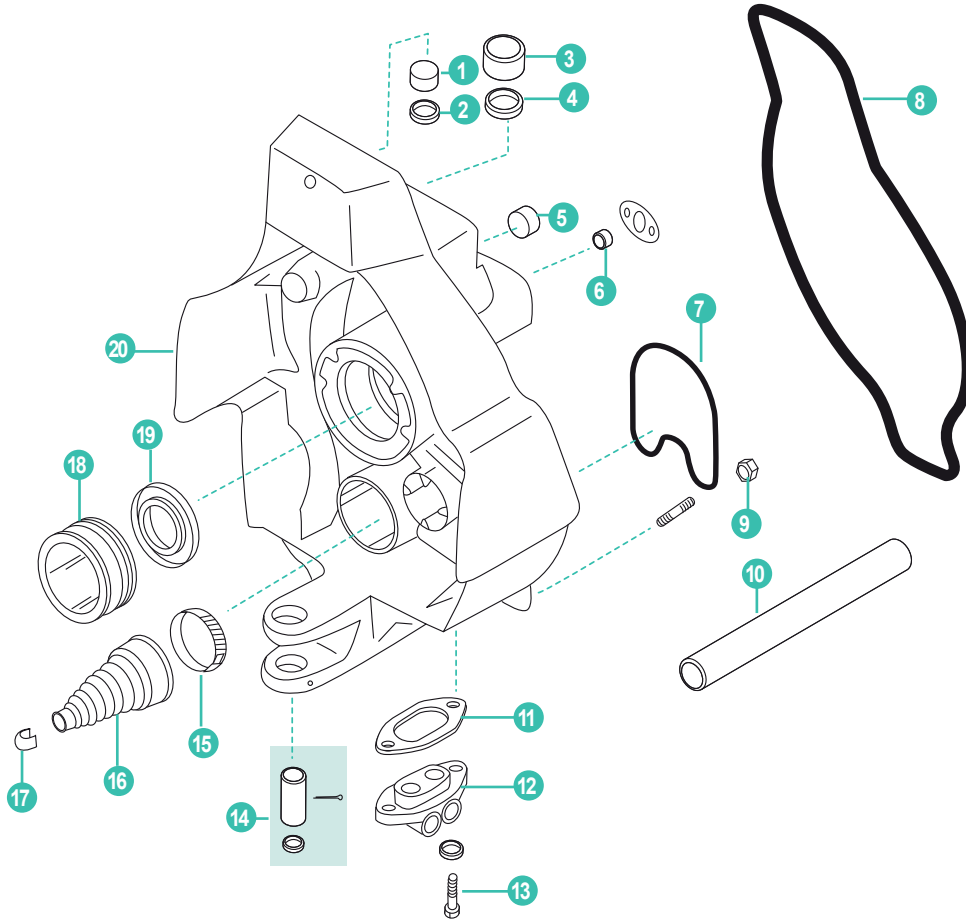

	REF	OEM				
1	RM23-98356	23-98356	CASQUILLO SUPERIOR	UPPER BUSHING	BOCCOLA SUPERIORE	BAGUE SUPÉRIEURE
2	REC26-54925	26-54925	RETÉN (Alpha one)	SEAL (Alpha one)	PARAOLIO (Alpha one)	JOINT (Alpha one)
3	RM23-983571	23-983571	CASQUILLO INFERIOR	LOWER BUSHING	BOCCOLA INFERIORE	BAGUE INFÉRIEUR
4	REC26-55682	26-55682	RETÉN (Alpha one)	SEAL (Alpha one)	PARAOLIO (Alpha one)	JOINT (Alpha one)
	REC26-8M2005029	26-416071	RETÉN (Alpha one Gen II)	SEAL (Alpha one Gen II)	PARAOLIO (Alpha one Gen II)	JOINT (Alpha one Gen II)
5	REC22-73379	22-73379	TAPÓN (.250-18)	CAP (.250-18)	TAPPO (.250-18)	BOUCHON (.250-18)
6	RM23-816599	23-816599	CASQUILLO	BUSHING	BOCCOLA	BAGUE
7	REC41802	41802	RETÉN	SEAL	TENUTA	JOINT D'HUILE
8	REC43713	43713	JUNTA TRANSOM (Gen II, Bravo)	BLACKHAWK TRANSOM SEAL (Gen II, Bravo)	GUARNIZIONE TRANSOM (Gen II, Bravo)	JOINT TRANSOM (Gen II, Bravo)
	REC65533A1	65533A1	JUNTA TRANSOM (MC1/R/Alpha one)	TRANSOM SEAL (MC1/R/Alpha one)	GUARNIZIONE TRANSOM (MC1/R/Alpha one)	JOINT TRANSOM (MC1/R/Alpha one)
9	REC11-34933	11-34933	TUERCA	NUT	DADO	ÉCROU
10	REC32-4172533	32-4172533	TUBO AGUA Ø 3/4"	Ø 3/4" WATER HOSE	Ø 3/4" TUBO ACQUA	DURITE ENTREE D'EAU Ø 3/4"
	REC32-32461	32-32461	TUBO AGUA Ø 5/8"	Ø 5/8" WATER HOSE	Ø 5/8" TUBO ACQUA	DURITE ENTREE D'EAU Ø 5/8"
11	REC27-988231	27-988231	JUNTA	GASKET	GUARNIZIONE	JOINT
12	REC8M0080805	8M0080805	KIT CONECTOR	TRIM CONNECTOR KIT	KIT CONNETTORE TRIM,	KIT CONNECTEUR
13	REC10-28668	10-28636	TORNILLO	SCREW	VITE	VIS
14	REC17-8M0073409	8M0073409	KIT PIN	KIT PIN	KIT SPINOTTO	KIT CLAVETTE
15	REC54-815504320	54-815504320	ABRAZADERA	CLAMP	FASCETTA	COLLIER
16	REC74639Q02	74639Q02	FUELLE CABLE CAMBIO	SHIFT BELLOW	CAVO CAMBIO A SOFFIETTO	SOUFFLET CÂBLE CHANGEMENT
17	REC54-38863	54-38863	ABRAZADERA	CLAMP	FASCETTA	COLLIER
18	REC30-879194A01	30-879194A01	COJINETE TRANSOM (Alpha one Gen I, II)	GIMBAL BEARING FOR TRANSOM (Alpha one Gen I, II)	CUSCINETTO TRANSOM (Alpha one Gen I, II)	ROULEMENT TRANSOM (Alpha one Gen I, II)
19	REC26-88416	26-88416	RETÉN	SEAL	PARAOLIO	JOINT
20	RM94989A6	94989A6	TRANSOM GEN I (eje cuadrado / estriado)	GEN I TRANSOM (square / splined shaft)	TRANSOM GEN I (asse quadrato / scanalato)	TRANSOM GEN I (axe carré / cannelé)
	RM42260A6	42260A6	TRANSOM GEN I (eje cuadrado / cuadrado)	GEN I TRANSOM (squared fixation shaft)	TRANSOM GEN I (asse quadrato)	TRANSOM GEN I (axe carré)
	RM43881A14	8M0062568	TRANSOM (1991+) GEN II	GIMBAL HOUSING ASSY. (1991+)	TRANSOM (1991+) GEN II	TRANSOM (1991+) Gen II
21	REC22-88847A1	22-88847A1	KIT TUERCA Y TAPONES	PLUG KIT	KIT DADO TAPPO	KIT ÉCROU ET BOUCHONS
22	REC30-879194A01	30-879194A01	COJINETE TRANSOM (Alpha one Gen I, II)	GIMBAL BEARING FOR TRANSOM (Alpha one Gen I, II)	CUSCINETTO TRANSOM (Alpha one Gen I, II)	ROULEMENT TRANSOM (Alpha one Gen I, II)
			CONECTOR HIDRÁULICO	HYDRAULIC CONNECTOR	CONNETTORE IDRÁULICO	JOINT
23	REC27-47644-1	27-47644-1	Alpha One S (1986-89)	Alpha One S (1986-89)	Alpha One S (1986-89)	Alpha One S (1986-89)
			SSM II / III / IV / V (1982-95)	SSM II / III / IV / V (1982-95)	SSM II / III / IV / V (1982-95)	SSM II / III / IV / V (1982-95)
			Para conector: 47347	For connector: 47347	Per connettore: 47347	Pour connecteur: 47347
24	REC8M0080805	8M0080805	KIT CONECTOR TRIM	TRIM CONNECTOR KIT	KIT CONNETTORE TRIM	KIT CONECTEUR TRIM
	CM55989		ÁNODO ZN	ANODE ZN	ANODO ZN	ANODE ZN
25	CM55989A	55989Q9	ÁNODO AL	ANODE AL	ANODO AL	ANODE AL
	REC55989Q9		KIT ÁNODO AL	ANODE AL KIT	KIT ANODO AL	KIT ANODE AL
26	REC27-995061	27-995061	JUNTA	GASKET	GUARNIZIONE	JOINT
	CM821631	821631Q1	ÁNODO ZN	ANODE ZN	ANODO ZN	ANODE ZN
27	CM821631A	821631Q1	ÁNODO AL	ANODE AL	ANODO AL	ANODE AL

TRANSOM COMPLETO			TRANSOM ASSY			TRANSOM COMPLETO			TRANSOM COMPLET		
REF	OEM		REF	OEM		REF	OEM		REF	OEM	
TRANSONALPHA1	6-601000CP	Alpha One Gen I	TRANSONALPHA2G	6-6111002LP	Alpha One Gen II						
											

CAMPANA TRANSOM, CABLE CAMBIO Y BOMBA DIRECCION

TRANSOM PLATE, SHIFT CABLE & PUMP ASSY. POWER STEERING

CAMPANA TRANSOM, CAVO CAMBIO E POMPA STERZO

CASQUE, CÂBLE CHANGEMENT ET POMPA DIRECTION



REF  
REC87-814281A5



REF  
RM8M0052936



REF  
REC87-808009A2



REF  
REC8M0052939



REF  
REC10-31700



REF  
REC73873A1



REF  
REC861578

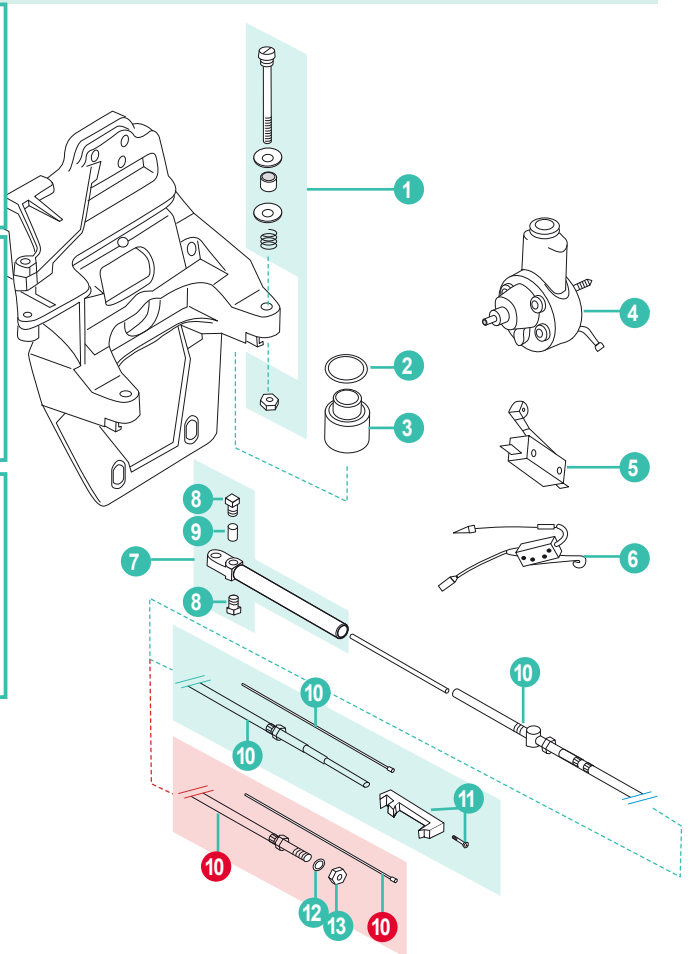

	REF	OEM				
1	REC10-97934A1	10-97934A1	KIT MONTAJE SILENTBLOCK CAMPANA	MOTOR MOUNT BOLT KIT	KIT SILENTBLOCK CAMPANA	KIT VISSERIE
2	REC23-99322	23-99322	ESPACIADOR SILENTBLOCK	SILENTBLOCK SPACER	SILENTBLOCK DISTANZIALE	CALE
3	REC865329A02	865329A02	SILENTBLOCK MOTOR	MOTOR MOUNT SILENTBLOCK	SILENTBLOCK MOTORE	KIT SILENTBLOCK MOTEUR
4	REC16792A39	16792A39	BOMBA DIRECCION	PUMP ASS. POWER STEERING	POMPA DI STERZO	POMPE DIRECTION
5	RM864363A1	864363A1	MICRORRUPTOR ANTIGUO	SHIFT PLATE KIT, OLD	MICROINTERRUTTORE VECCHIO	MICROSWITCH DE TRANSOM ANCIEN
6	RM864364A1	864364A1	MICRORRUPTOR	SHIFT PLATE KIT	MICROINTERRUTTORE	MICROSWITCH
7	REC02644		GUÍA CABLE CAMBIO	GUIDE	GUIDA CAVO CAMBIO	EMBOUIT DE CABLE D'INVERSEUR
8	REC10-20518	10-20518	TORNILLO	BOLT	VITE	VIS
9	REC43436	43436	ANCLAJE	ANCHOR	SEDE	ANCRAGE
10	REC865436A02	865436A02	CABLE CAMBIO (R/MR/Alpha one Gen II)	(R/MR/Alpha one Gen II) SHIFT CABLE	CAVO CAMBIO (R/MR/Alpha one Gen II)	CÂBLE CHANGEMENT (R/MR/Alpha one Gen II)
10	RM19543A10	865436A02	CABLE CAMBIO ORIGINAL (R/MR/Alpha one Gen II)	(R/MR/Alpha one Gen II) SHIFT CABLE ORIGINAL	CAVO CAMBIO ORIGINAL (R/MR/Alpha one Gen II)	CABLE CHANGEMENT ORIGINAL (R/MR/Alpha one Gen II)
10	REC865437A02	865437A02	CABLE CAMBIO (Bravo)	(Bravo) SHIFT CABLE	CAVO CAMBIO (Bravo)	CÂBLE CHANGEMENT (Bravo)
11	REC8507522	8507522 + 10-31700	KIT ACOPLE CABLE CAMBIO	SHIFT CABLE SLIDE	KIT ACCOPIAMENTO CAVO CAMBIO	KIT ATTACHE CABLE
12	REC12-815472	12-815472	ARANDELA (Bravo)	WASHER (Bravo)	RONDELLA (Bravo)	RONDELLE (Bravo)
13	RM11-49910	11-49910	(Bravo)	NUT (Bravo)	DADO (Bravo)	ÉCROU (Bravo)
14	REC87-814281A5	87-814281A5	MICRORRUPTOR 3.0L, LX, 4.3L, LXL, 5.0L Et 5.7, LX (1996+)	SHIFT PLATE KIT 3.0L, LX, 4.3L, LXL, 5.0L Et 5.7, LX (1996+)	MICROINTERRUTTORE 3.0L, LX, 4.3L, LXL, 5.0L Et 5.7, LX (1996+)	MICROSWITCH 3.0L, LX, 4.3L, LXL, 5.0L Et 5.7, LX (1996+)
15	RM8M0052936	87-8M0052936 87-808009A1 87-808009A3	MICRORRUPTOR 4.3MPI, 5.0LMPi, 350MAG MPI, MX, 6.2L MPI, 4.3, 5.0, 5.7L EFI, LX	SHIFT PLATE KIT 34.3MPI, 5.0LMPi, 350MAG MPI, MX, 6.2L MPI, 4.3, 5.0, 5.7L EFI, LX	MICROINTERRUTTORE 4.3MPI, 5.0LMPi, 350MAG MPI, MX, 6.2L MPI, 4.3, 5.0, 5.7L EFI, LX	MICROSWITCH 4.3MPI, 5.0LMPi, 350MAG MPI, MX, 6.2L MPI, 4.3, 5.0, 5.7L EFI, LX
16	REC87-808009A2	87-808009A2 87-8M0052935	MICRORRUPTOR 4.3MPI, 5.0LMPi, 350MAG MPI, MX, 6.2L MPI	SHIFT PLATE KIT 4.3MPI, 5.0LMPi, 350MAG MPI, MX, 6.2L MPI	MICROINTERRUTTORE 4.3MPI, 5.0LMPi, 350MAG MPI, MX, 6.2L MPI	MICROSWITCH 4.3MPI, 5.0LMPi, 350MAG MPI, MX, 6.2L MPI
17	REC8M0052939	8M0052939 889514A01 814281A7	INTERRUPTOR DIGITAL CAMBIO GASOLINA Y GASOIL	SWITCH DIGITAL THROTTLE FUEL Et DIESEL	DIGITAL INTERRUPTORE DIESEL E BENZINA	DIGITAL INTERRUPTEUR DIESEL ET ESSENCE
18	REC10-31700	10-31700	TORNILLO	SCREW	VITE	VIS
19	REC73873A1	73873A1	POLEA "V" BOMBA SERVO	P/S PUMP PULLEY	PULEGGIA "V"	POULIE "V"
20	REC861578	861578	POLEA SERPENTÍN	P/S PUMP PULLEY	PULEGGIA SERPENTINA	POULIE SERPENTINE



**SOPORTE TRANSOM  
ALPHA ONE GEN II**

**GIMBAL HOUSING RING  
ASSEMBLY  
ALPHA ONE GEN II**

**SUPPORTO TRANSOM  
ALPHA ONE GEN II**

**SUPPORT TRANSOM  
ALPHA ONE GEN II**



REF  
REC805320A03

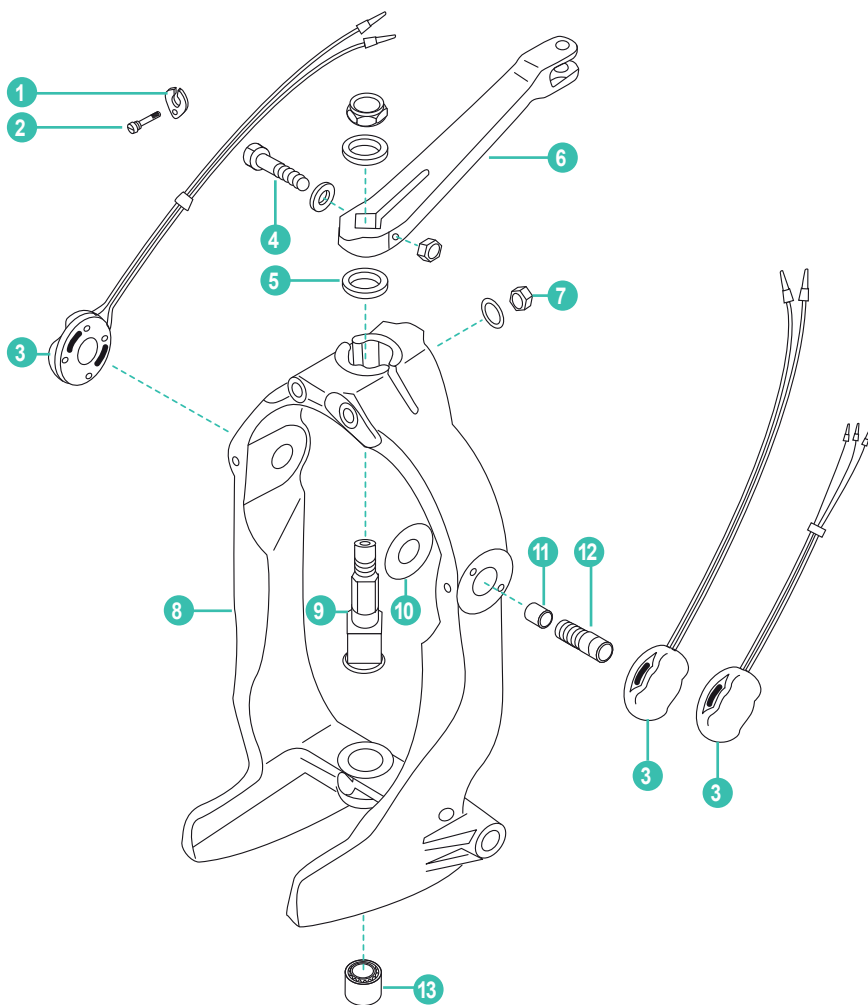

	REF	OEM				
1	RM54-12078	54-12078	ABRAZADERA	CLAMP	FASCETTA	COLLIER
2	RM10-28635	10-28635	TORNILLO SUJECCIÓN	SCREW	VITE	VIS
3	REC805320A03	805320A03	KIT SENSORES TRIM ANALÓGICO	TRIM SENSOR KIT. ANALOGICAL	KIT SENSORI TRIM	KIT SONDE DE TRIM
	REC8M0095310	8M0095310	KIT SENSOR TRIM DIGITAL	TRIM SENSOR KIT. DIGITAL	SENSORE TRIM DIGITAL	SONDE DE TRIM DIGITAL
4	RM10-807204	10-807204	TORNILLO	SCREW	VITE	VIS
5	RM12-98548	12-98548	ARANDELA	WASHER	RONDELLA	RONDELLE
6	RM866322A01	866322A01	BIELA DIRECCIÓN	LEVER ASSY	BIELLA STERZO	PIVOT DE DIRECTION
7	REC11-862903	11-134371	TUERCA	NUT	DADO	ÉCROU
8	RM865328A01	865328A01	SOPORTE TRANSOM Design II (OM815639+)	GIMBAL RING ASSEMBLY Design II (OM815639+)	SUPPORTI TRANSOM Design II (OM815639+)	FOURCHE DE DIRECTION Gen II (OM815639+)
9	REC98230A1	98230A1	EJE	SHAFT	ASSE	ARBRE
10	RM12-41721	12-41721	ARANDELA	WASHER	RONDELLA	RONDELLE
11	REC23-847637	23-847637	CASQUILLO	BUSING	BOCCOLA	BAGUE
12	REC77123	77123	TORNILLO ALPHA (-1998) (-OM815638)	ALPHA SCREW (-1998) (-OM815638)	VITE ALPHA (-1998) (-OM815638)	VIS Alpha (-1998) (-OM815638)
	REC10-86801	10-86801	TORNILLO ALPHA (1998+) (OM85639+)	ALPHA SCREW (1998+) (OM85639+)	VITE ALPHA (1998+) (OM85639+)	VIS Alpha (1998+) (OM815639+)
13	RM23-99352	23-99352	COJINETE	BEARING	CUSCINETTO	ROULEMENT
	REC806034A1	866200A01	PISTÓN DIRECCIÓN MODERNA (1991+) Plástico	NEWER POWER STEERING PISTON (1991+) Plastic	PISTONE IDRAULICO MODERNO (1991+) Plastica	VERIN DE DIRECTION MODERN (1991+) Plastique
14	RM806034A2	806034A2	PISTON DIRECCIÓN ANTIGUA (-1991) Metálico	OLDER POWER STEERING PISTON (-1991) Metal	PISTONE IDRAULICO VECCHIO (-1991) Metallo	VERIN DE DIRECTION ANCIEN (-1991) Métalique

CAMPANA TRANSOM  
MC, MR1, ALPHA ONE,  
ALPHA ONE GEN II

BELL HOUSING  
MC, MR1, ALPHA ONE,  
ALPHA ONE GEN II

CAMPANA TRANSOM  
MC, MR1, ALPHA ONE,  
ALPHA ONE GEN II

CASQUE  
MC, MR1, ALPHA ONE,  
ALPHA ONE GEN II

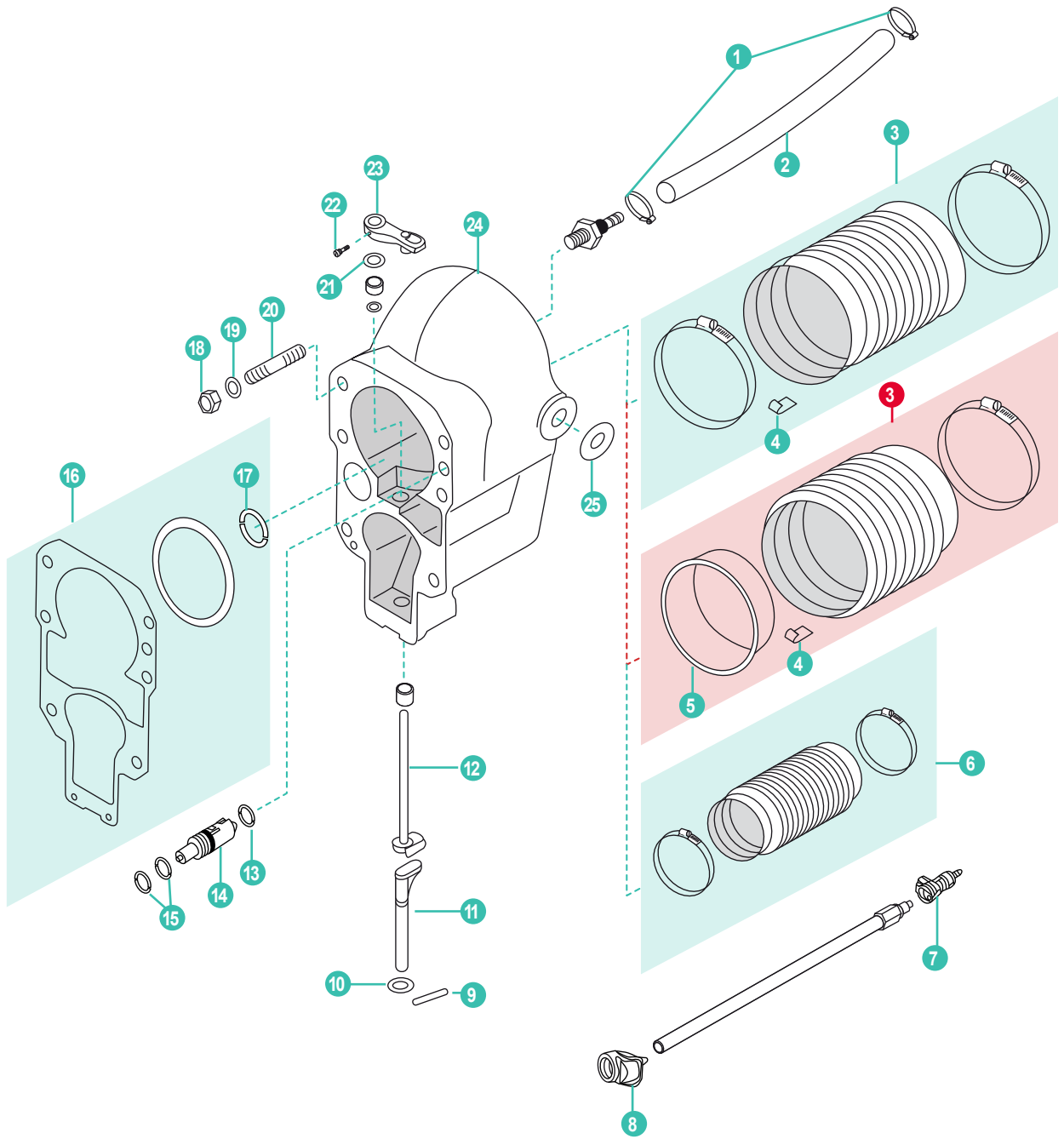

	REF	OEM				
1	REC54-815504412	54-815504412	ABRAZADERA	CLAMP	FASCETTA	COLLIER
2	REC32-4172533	32-4172533	TUBO AGUA Ø 3/4 137/8"L	WATER HOSE Ø 3/4 137/8"L	TUBO ACQUA Ø 3/4" 137/8"L	DURITE Ø 3/4" 137/8"L
	REC32-32461	32-32461	TUBO AGUA Ø 5/8 137/8"L	WATER HOSE Ø 5/8 137/8"L	TUBO ACQUA Ø 5/8" 137/8"L	DURITE Ø 5/8" 137/8"L
3	REC60932A4	60932A4	KIT FUELLE (3469428+) R/MR/ALPHA ONE	U-JOINT BELLOW (3469428+) KIT R/MR/ALPHA ONE	KIT CUFFIA (3469428+) R/MR/ALPHA ONE	KIT SOUFFLE (3469428+) R/MR/Alpha one
3	REC816431A1	816431A1	KIT FUELLE (Alpha one Gen II)	U-JOINT BELLOW KIT (Alpha one Gen II)	KIT CUFFIA (Alpha one Gen II)	KIT SOUFFLET (Alpha one Gen II)
4	REC54-86049	54-86049	CLIP FUELLE	GROUNDING CLIP	CLIP CUFFIA	CLIPS SOUFFLET
5	REC816607	816607	CASQUILLO FUELLE	BELLOW FLANGE RING	ANELLO	BAGUE
6	REC18654A1	18654A1	KIT FUELLE ESCAPE	U-JOINT BELLOW KIT	KIT CUFFIA DI SCARICO	KIT SOUFFLET ÉCHAPPEMENT
7	REC22-865417	22-865417	CONECTOR HEMBRA (Design II OM815639+)	FITTING FEMALE QUICK CONNECT (Design II OM815639+)	CONETTORE FEM (Design II OM815639+)	CONNECTEUR FEM (Design II OM815639+)
8	REC22-860382	22-860382	CONECTOR VELOCIMETRO	COUPLING ASSEMBLY SPEEDOMETER	CONNETTORE DEL TACHIMETRO	CONNECTEUR DE COMPTEUR DE VITESSE
9	REC18-32665	18-32665	PASADOR	COTTER PIN	CHIAVISTELLO	GOUPILLE
10	REC12-32666	12-32666	ARANDELA	WASHER	RONDELLA	RONDELLE
11	REC621041	621041	EJE INTERMEDIO	INTERMEDIATE SHIFT SHAFT	ASSE INTERMEDIO	ARBRE
12	REC816685	816685	EJE CABLE CAMBIO (Alpha one Gen II)	UPPER SHIFT SHAFT (Alpha one Gen II)	ASSE CAMBIO (Alpha one Gen II)	ARBRE CÂBLE CHANGEMENT (Alpha one Gen II)
	REC45589A3	45589A3	EJE CABLE CAMBIO (Alpha one Gen I)	UPPER SHIFT SHAFT (Alpha one Gen I)	ASSE CAMBIO (Alpha one Gen I)	ARBRE CÂBLE CHANGEMENT (Alpha one Gen I)
13	REC25-62705	25-62705	ANILLO	O-RING	O-RING	JOINT TORIQUE
14	REC18920A1	18920A1	VÁLVULA COMPLETA	VALVE ASSY	VALVOLA COMPLETA	SOUPAPE COMPLETE
15	REC25-48171	25-48171	ANILLO	O-RING	O-RING	JOINT TORIQUE
16	REC27-94996Q2	27-94996Q2	KIT JUNTAS TRANSOM (Alpha one & Gen II)	GASKET KIT (Alpha one & Gen II)	KIT GUARNIZIONI TRANSOM (Alpha one & Gen II)	KIT JOINS (Alpha one & Gen II)
	REC27-64818Q4	27-64818Q4	KIT JUNTAS TRANSOM (MC1)	GASKET KIT (MC1)	KIT GUARNIZIONI TRANSOM (MC1)	KIT JOINTS (MC1)
17	REC0307239	25-33504	ARO TÓRICO	O-RING	O-RING	JOINT TORIQUE
18	REC11-34933	11-134391	TUERCA (.4375-20)	NUT (.4375-20)	DADO (.4375-20)	ÉCROU (.4375-20)
19	REC12-45176	12-35935	ARANDELA (.435 x .875 x .105)	WASHER (.435 x .875 x .105)	RONDELLA (.435 x .875 x .105)	RONDELLE (.435 x .875 x .105)
20	REC16-59579	16-59579	TORNILLO	SCREW	VITE	VIS
21	REC12-39116	12-39116	JUNTA	GASKET	GUARNIZIONE	JOINT
22	REC10-45590	10-45590	TORNILLO CIERRE	SET SCREW	VITE	VIS
23	REC45518A3	45518A3	PASADOR	SHIFT ARM	CHIAVISTELLO	GOUPILLE
24	RM42815A6	42815A6	CAMPANA TRANSOM Alpha one (1983-90)	BELL HOUSING Alpha one (1983-90)	CAMPANA TRANSOM Alpha one (1983-90)	CASQUE TRANSOM Alpha one (1983-90)
	RM806031A2	806031A2	CAMPANA TRANSOM GEN II (1991+)	GEN II BELL HOUSING (1991+)	CAMPANA TRANSOM GEN II (1991+)	CASQUE TRANSOM GEN II (1991+)
25	REC12-72498	12-72498	ARANDELA	WASHER	RONDELLA	RONDELLE
26	RM53-87843	53-87843	CIRCLIP	CIRCLIP	CIRCLIP	CLIPS
27	REC23-806036A1	23-806036A1	KIT RETENES Alpha Gen II, (F094775+)	SHIFT SHAFT BUSING Alpha Gen II, (F094775+)	KIT TENUTE Alpha Gen II, (F094775+)	KIT JOINTS Alpha Gen II, (F094775+)
28	REC23-805041A2	23-805041A2	KIT RETENES R/MR, Alpha Gen II, (-F094774)	SHIFT SHAFT BUSING R/MR, Alpha Gen II, (-F094774)	KIT TENUTE R/MR, Alpha Gen II, (-F094774)	KIT JOINTS R/MR, Alpha Gen II, (-F094774)
29	REC45518T1	45518T1	KIT CAMBIO	SHIFT LEVER KIT	KIT CAMBIO	KIT CHANGEMENT
30	REC22-861150T02	22-861150A1	RACOR ACEITE	OIL RACORD	RACORDO OLIO	RACORD D'HUILE
31	RM22-861163	22-861163	RACOR ACEITE	OIL RACORD	RACORDO OLIO	RACORD D'HUILE



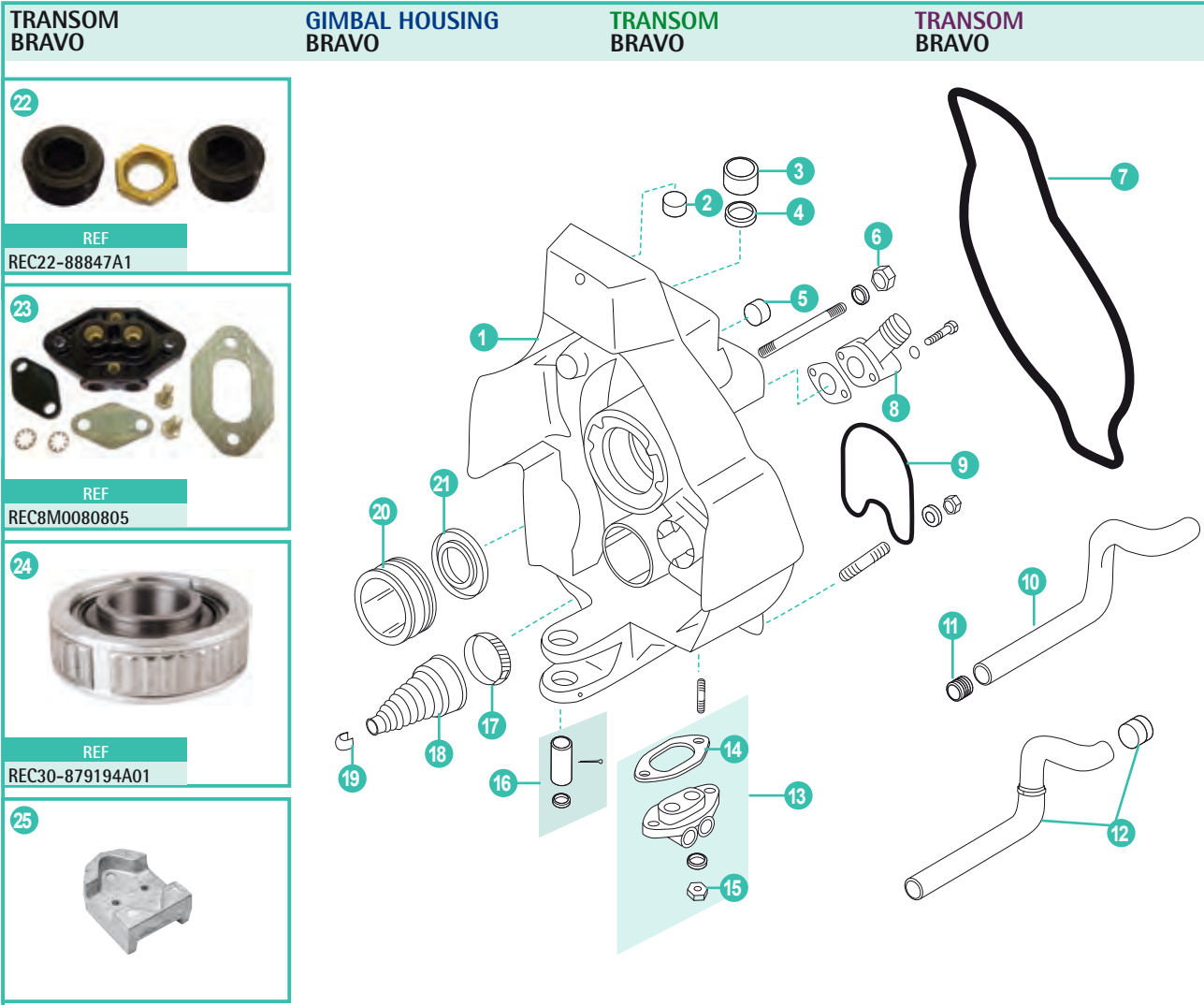

REF  
REC22-88847A1



REF  
REC8M0080805



REF  
REC30-879194A01



	REF	OEM				
1	RM43881A17	43881A17	CARCASA	GIMBAL HOUSING ASSY.	CARCASSA	PLATINE
2	RM23-98356	23-98356	CASQUILLO SUPERIOR	UPPER BUSHING	BOCCOLA SUPERIORE	BAGUE SUPÉRIEURE
3	RM23-983571	23-983571	CASQUILLO INFERIOR	BUSHING - LOWER	BOCCOLA INFERIORE	BAGUE IN'FÉRIEUR
4	REC26-8M2005029	26-416071	RETÉN	OIL SEAL	PARAOLIO	JOINT D'HUILE
5	REC22-428611	22-428611	TAPÓN	PLUG	TAPPO	BOUCHON
6	REC11-34933	11-34933	TUERCA	NUT	DADO	ÉCROU
7	REC43713	43713	JUNTA TRANSOM	TRANSOM SEAL	GUARNIZIONE TRANSOM	JOINT TRANSOM
8	RM22-43828	22-43828T	CONECTOR (-OW099999)	CONNECTOR (-OW099999)	PIPETTA (-OW099999)	CONNECTEUR (-OW099999)
	RM865470	865470	CONECTOR (OW100000+)	CONNECTOR (OW100000+)	PIPETTA (OW100000+)	CONNECTEUR (OW100000+)
9	REC41802	41802	RETÉN	SEAL	TENUTA	JOINT D'HUILE
10	REC32-43437	32-43437	TUBO AGUA DESIGN I	WATER HOSE DESIGN I	TUBO ACQUA DESIGN I	DURITE DESIGN I
11	REC41674T	41674T	CASQUILLO	INSERT	BOCCOLA	BAGUE
12	REC8M0062102	32-8M0062102	TUBO DE AGUA DESIGN II	WATER HOSE DESIGN II	TUBO ACQUA DESIGN II	DURITE DESIGN II
13	REC8M0080805	8M0080805	KIT CONECTOR	CONNECTOR KIT	CONNETTORE	KIT CONECTEUR
14	REC27-988231	27-988231	JUNTA	GASKET	GUARNIZIONE	JOINT
15	REC11-8267089	11-8267089	TUERCA	NUT	DADO	ÉCROU
16	REC17-8M0073409	17-8M0073409	KIT PIN	PIN SET	KIT SPINOTTO	KIT GOUPILLE
17	REC54-815504320	54-815504320	ABRAZADERA	CLAMP	FASCETTA	COLLIER
18	REC74639Q02	74639Q02	FUELLE CABLE CAMBIO	SHIFT CABLE BELLOW	CUFFIA CAMBIO	SOUFFLET CÂBRE CHANGEMENT
19	REC54-38863	54-38863	ABRAZADERA	CLAMP	FASCETTA	COLLIER
20	REC30-879194A01	879194A01 Et A02	COJINETE	GIMBAL BEARING	CUSCINETTO	ROULEMENT
21	REC26-88416	26-88416	RETÉN ACEITE	OIL SEAL	PARAOLIO	JOIT D'HUILE
22	REC22-88847A1	22-88847A1	KIT TUERCA Y TAPONES	PLUG KIT	KIT DADO TAPPO	KIT ÉCROU ET BOUCHON
23	REC8M0080805	8M0080805	KIT CONECTOR TRIM	TRIM CONNECTOR KIT	KIT CONNETTORE TRIM	KIT CONNECTEUR TRIM
24	REC30-879194A01	30-879194A01	COJINETE	BEARING	CUSCINETTO	ROULEMENT
25	CM821631	821631Q	ÁNODO ZN	ANODE ZN	ANODO ZN	ANODE ZN
	CM821631A	821631Q	ÁNODO AL	ANODE AL	ANODO AL	ANODE AL



**CAMPANA BRAVO**

**BELL HOUSING BRAVO**

**CAMPANA BRAVO**

**CASQUE BRAVO**



REF  
RM53-87843

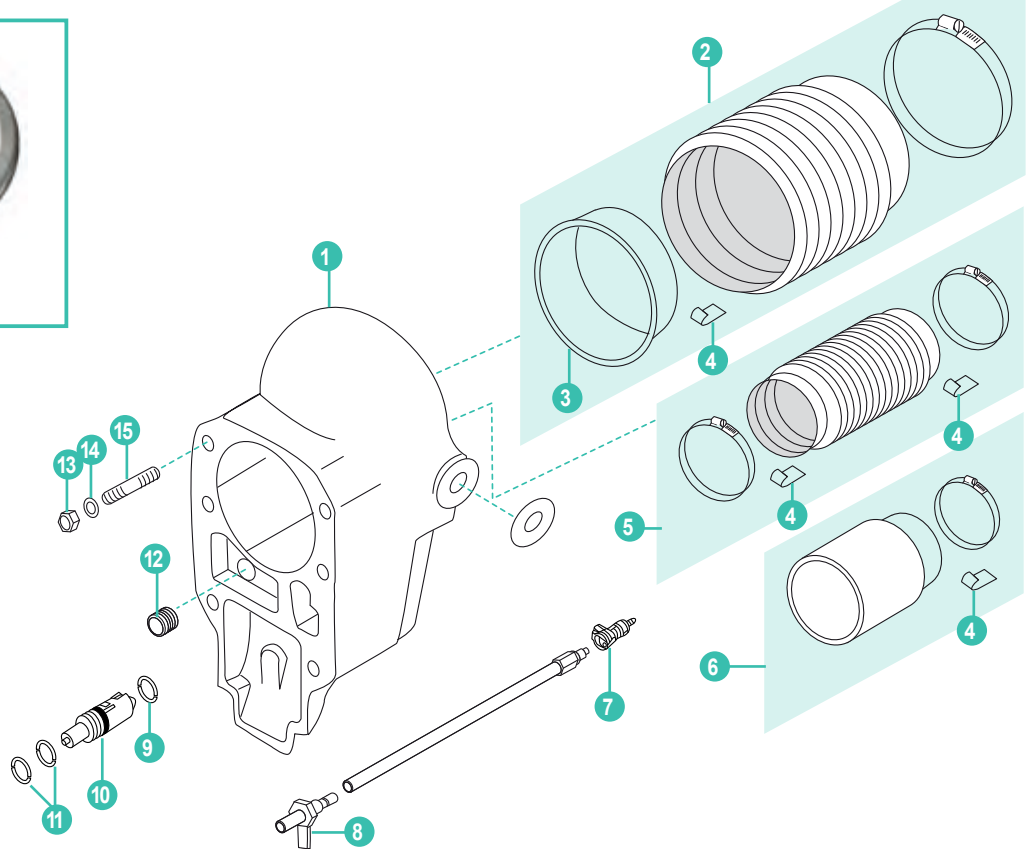

REF  
REC16755Q1



REF  
REC23-861209A1



REF  
REC22-861150T02



REF  
RM22-861163

	REF	OEM			
1	RM41646A9	41646A9	CAMPANA Bravo I, II, III (-2A514802)	Bravo I, II, III BELL HOUSING (-2A514802)	CAMPANA Bravo I, II, III (-2A514802)
2	REC86840A05	86840A05	FUELLE TRANSON	U-JOINT BELLOW	CUFFIA TRANSON
3	REC862209	862209	CASQUILLO FUELLE	BELLOW FLANGE RING	ANELLO
4	REC54-86049	54-86049	CLIP	CLIP	CLIP
5	REC18654A1	18654A1	FUELLE ESCAPE	EXHAUST BELLOW	CUFFIA SCARICO
6	REC78458A1	78458A1	TUBO ESCAPE	EXHAUST TUBE	TUBO DI SCARICO
7	REC22-865417	22-865417	CONECTOR	FITTING	CONETTORE
8	REC815303T	815303T	ADAPTADOR	ADAPTER	ADATTATORE
9	REC25-62705	25-62705	ARO	O-RING	ANELLO
10	REC18920A1	18920A1	VÁLVULA COMPLETA	VALVE ASSEMBLY	VALVOLA COMPLETA
11	REC25-48171	25-48171	ARO	O-RING	ANELLO
12	REC41674T	41674T	KIT CASQUILLO	INSERT	KIT GHIERA
13	REC11-34933	11-859116	CIERRE	LOCKNUT	CHIUSURA
14	REC12-45176	12-35935	ARANDELA	WASHER	RONDELLA
15	REC16-59579	16-59579	TORNILLO	SCREW	VITE
16	RM53-87843	53-87843	CIRCLIP	CIRCLIP	CIRCLIP
17	REC22-861150T02	22-861150A1	RACOR ACEITE	OIL RACORD	RACORDO OLIO
18	RM22-861163	22-861163	RACOR ACEITE	OIL RACORD	RACORDO OLIO
19	REC16755Q1	16755Q1	KIT JUNTAS Bravo Et Blackhawk	GASKET SET Bravo Et Blackhawk	KIT GUARNIZIONE Bravo Et Blackhawk
20	REC23-861209A1	23-861209A1	KIT RETENES	SHIFT SHAFT BUSING	KIT TENUTE
					CASQUE TRANSOM Bravo I, II, III (-2A514802)
					SOUFFLET
					BAGUE
					CLIPS
					SOUFFLET ÉCHAPPEMENT
					DURITE ÉCHAPPEMENT
					CONNECTEUR
					ADAPTATEUR
					JOINT TORIQUE
					SOUPAPE COMPLET
					JOINT TORIQUE
					KIT BAGUE
					ECROU INOX
					RONDELLE
					VIS
					CLIPS
					RACCORD HUILE
					RACCORD HUILE
					KIT JOINTS Bravo et Blackhawk
					KIT JOINTS D'HUILE

SOPORTE TRANSOM BRAVO I, II, III

GIMBAL HOUSING RING ASSEMBLY. BRAVO I, II, III

SUPPORTO TRANSOM BRAVO I, II, III

SUPPORT TRANSOM BRAVO I, II, III

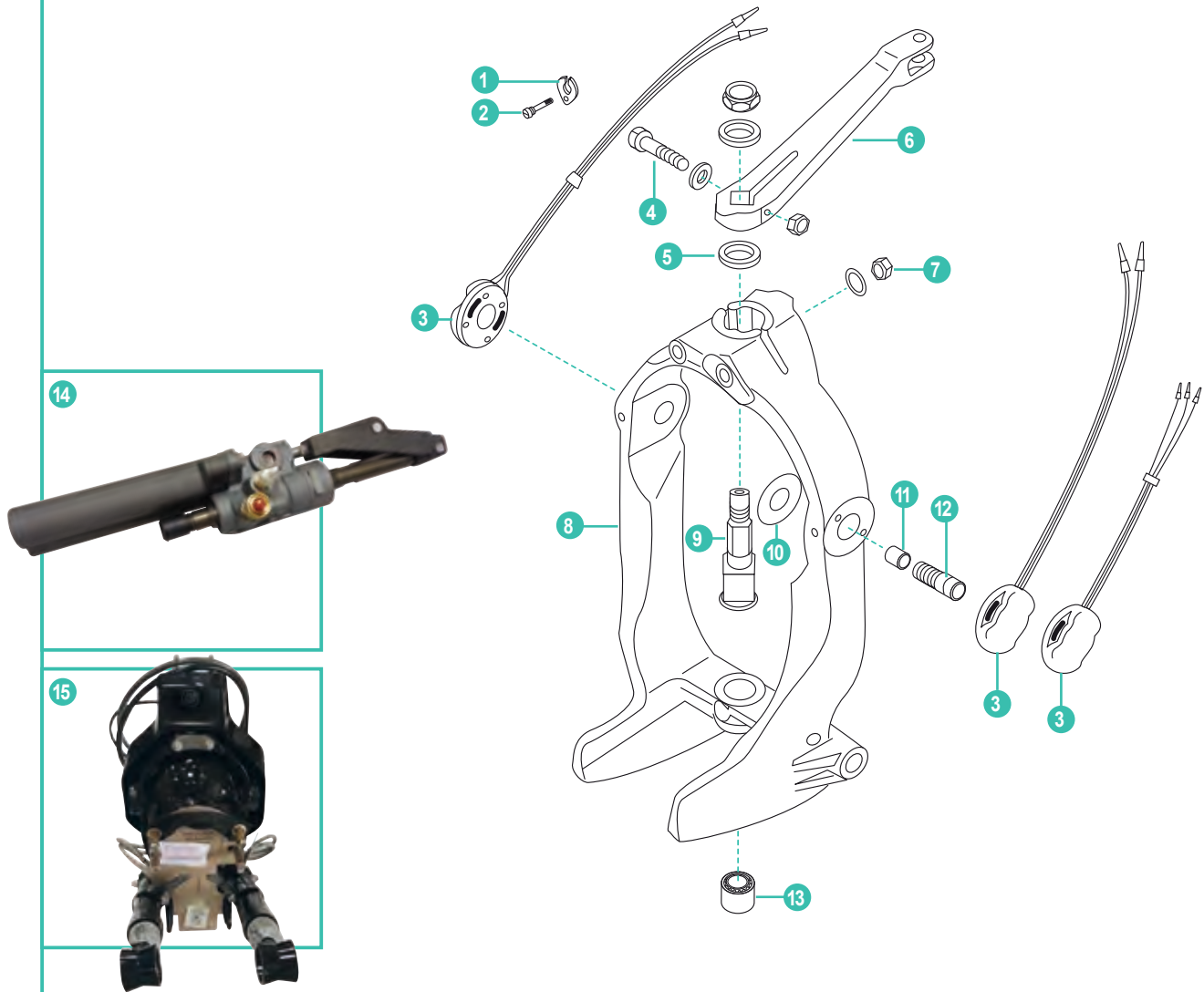









	REF	OEM				
1	RM54-12078	54-12078	ABRAZADERA	CLAMP	FASCETTA	COLLIER
2	RM10-28635	10-28635	TORNILLO SUJECCIÓN	SCREW	VITE	VIS
3	REC805320A03	805320A03	KIT SENSORES TRIM	TRIM SENSOR KIT	KIT SENSORI TRIM	KIT SONDES TRIM
	REC8M0095310	8M0095310	KIT SENSOR TRIM DIGITAL	TRIM SENSOR KIT, DIGITAL	KIT SENSORI TRIM, DIGITAL	KIT SONDES TRIM DIGITAL
4	RM10-807204	10-807204	TORNILLO	SCREW	VITE	VIS
5	RM12-98548	12-98548	ARANDELA	WASHER	RONDELLA	RONDELLE
6	RM866322A01	866322A01	BIELA DIRECCIÓN	LEVER ASSY	BIELLA STERZO	PIVOT DE DIRECTION
7	REC11-862903	11-134371	TUERCA	NUT	DADO	ÉCROU
8	RM8M0062440	8M0062440	SOPORTE TRANSOM	GIMBAL RING ASSEMBLY	SUPPORTO TRANSOM	FOURCHE DE DIRECTION
9	REC98230A1	98230A1	EJE	SHAFT	ASSE	ARBRE
10	RM12-41721	12-41721	ARANDELA	WASHER	RONDELLA	RONDELLE
11	REC23-847637	23-847637	CASQUILLO	BUSING	BOCCOLA	BAGUE
12	REC10-86801	10-86801	TORNILLO (1998+)	SCREW (1998+)	VITE (1998+)	VIS (1998+)
13	RM23-847638	23-847638	COJINETE MAGNUM	BEARING MAGNUM	CUSCINETTO MAGNUM	ROULEMENT MAGNUM
	RM23-99352	23-99352	COJINETE ESTÁNDAR	BEARING STANDARD	CUSCINETTO STANDARD	ROULEMENT STANDARD
14	REC806034A1	866200A01	PISTÓN DIRECCIÓN Moderno (1994+) Plástico	NEWER POWER STEERING PISTON (1994+) Plastic	PISTONE IDRAULICO Moderno (1994+) Plastica	PISTON DIRECTION moderne (1994+) plastique
	RM806034A2	806034A2	PISTÓN DIRECCIÓN (1983-1993) Metálico	OLDER POWER STEERING PISTON (1983-1993) Metalic	PISTONE IDRAULICO vecchio (1983-1993) Metallo	PISTONE DIRECTION ancien (1983-93) Métalique
15	TRANSONBRAVO	6-6211002NZ 6-6311002NZ	TRANSOM COMPLETO	TRANSOM ASSEMBLY	TRANSOM COMPLETO	TRANSOM COMPLET

**COMPONENTES TRANSOM**

**TRANSOM COMPONENTS**

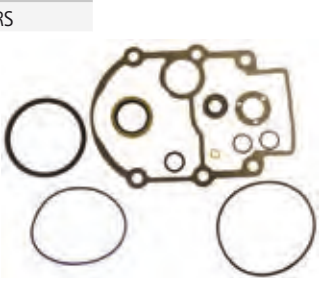
**COMPONENTI TRANSOM**

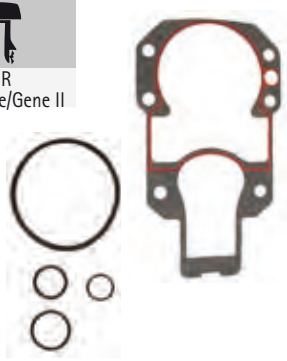
**COMPONENTS DU TRANSOM**

KITS DE JUNTAS		GASKET SET		KIT GUARNIZIONI		KIT JOINTS	
REF	OEM			REF	OEM		
REC27-54014Q1	27-54014Q1	TR/TRS		REC27-64818Q4	27-64818Q4	MC1/120 - 260	
REF	OEM			REF	OEM		
REC87580		TR/TRS		REC27-94996Q2	27-94996Q2	MC1/R/MR Alpha One/Gen II	
REF	OEM						
REC16755Q1	16755Q1	BRAVO					

KIT FUELLE		U-JPINT BELLOWS KIT		KIT CUFFIE		KIT SOUFFLET	
REF	OEM			REF	OEM		
REC60932A4	60932A4	1/R/Alpha One		REC86840A05	8M0062406		
CEF500516K	60932A1	(3469428+)		CEF500509K	86840A3	Bravo & Blackhawk	
					86840A05		
REF	OEM			REF	OEM		
REC36223A2	36223A2	Colas antiguas		REC816431A1	816431A1	Alpha One Gen II	
	36223	Old styles drives		CEF500515K			
CEF500522K	36223A1	Piedi vecchio					
		Embases anciennes					
		(-3443920)					

KIT FUELLE CABLE CAMBIO		SHIFT CABLE BELLOW KIT		KIT CUFFIA CAMBIO		KIT SOUFFLET CHANGEMENT	
REF	OEM						
REC74639Q02	74639Q02	ALPHA & BRAVO					
CEF500513K							

**CLIP FUELLE**      **BELLOW CLIP**      **CLIP CUFFIE**      **CLIPS**

REF	OEM
REC54-86049	54-86049



**ABRAZADERA FUELLE CAMBIO**      **SHIFT CABLE BELLOW CLAMP**      **FASCETTA CUFFIE CAMBIO**      **COLLIER SOUFFLET CHANGEMENT**

REF	OEM	
REC54-38863	54-38863	REC74639Q02



REF	OEM	
REC54-815504320	54-815504320	REC74639Q02



**FUELLE DE ESCAPE**      **EXHAUST BELLOWS**      **CUFFIE DI SCARICO**      **SOUFFLET D'ÉCHAPPEMENT**

REF	OEM	
REC78458A1	78458A1	Bravo I, II & III
CEF500520K	78458	



REF	OEM	Ø IN.
REC18654A1	18654A1	Alpha & Bravo
CEF500512K	32734	
	32734A3	



**CAMBIO**      **SHIFT**      **CAMBIO**      **CHANGEMENT**

**CABLE**      **CABLE**      **CAVO**      **CÂBLE**

REF	
REC21470	MCM Modelos modernos Newer models Modello moderno Modeles modernes



REF	OEM	
REC865436A02	865436A02	MCM Modelos modernos Newer models Modello moderno Modeles modernes
RM19543A10	ORIGINAL	

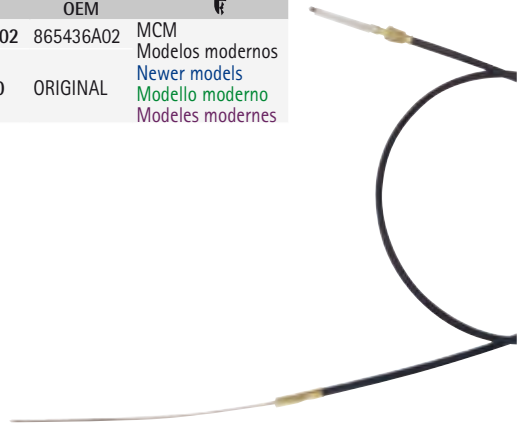

REF	OEM	
REC865437A02	865437A02	Bravo I, II, III



**KIT CABLE CAMBIO**      **SHIFT CABLE ASSY KIT**      **KIT CAVO CAMBIO**      **KIT CÂBLES CHANGEMENT**

REF	OEM	
REC865436A03		MC1/R/MR/Alpha One/Gen II



REF	OEM	
REC815471T1	815471T1	Bravo I, II, III





CABLES DE DIRECCIÓN

STEERING CABLE

CAVI DI TIMONERIA

CÂBLES DE COMMANDE

GEN I

Mercury, Mercruiser, Mariner

REF	OEM	
PREKM63706	8M0082479	6' / 1,80 m
PREKM63707	8M0082480	7' / 2,10 m
PREKM63708	8M0082481	8' / 2,45 m
PREKM63709	8M0082482	9' / 2,75 m
PREKM63710	8M0082483	10' / 3,05 m
PREKM63711	8M0082484	11' / 3,35 m
PREKM63712	8M0082485	12' / 3,65 m
PREKM63713	8M0082486	13' / 3,95 m
PREKM63714	8M0082487	14' / 4,25 m
PREKM63715	8M0082488	15' / 4,60 m
PREKM63716	8M0082489	16' / 4,90 m
PREKM63717	8M0082490	17' / 5,20 m
PREKM63718	8M0082491	18' / 5,50 m
PREKM63719	8M0082492	19' / 5,80 m
PREKM63720	8M0082493	20' / 6,10 m
PREKM63721	8M0082494	21' / 6,40 m
PREKM63722	8M0082495	22' / 6,70 m
PREKM63723	8M0082496	23' / 7,00 m
PREKM63724	8M0082497	24' / 7,30 m



GEN II

Mercury 4000 / 4500 GEN II PLATINUM

REF	OEM	
PRE53006	8M0082529	6' / 1,80 m
PRE53007	8M0082530	7' / 2,10 m
PRE53008	8M0082531	8' / 2,45 m
PRE53009	8M0082532	9' / 2,75 m
PRE53010	8M0082533	10' / 3,05 m
PRE53011	8M0082534	11' / 3,35 m
PRE53012	8M0082535	12' / 3,65 m
PRE53013	8M0082536	13' / 3,95 m
PRE53014	8M0082537	14' / 4,25 m
PRE53015	8M0082538	15' / 4,60 m
PRE53016	8M0082539	16' / 4,90 m
PRE53017	8M0082540	17' / 5,20 m
PRE53018	8M0082541	18' / 5,50 m
PRE53019	8M0082542	19' / 5,80 m
PRE53020	8M0082543	20' / 6,10 m
PRE53021	8M0082544	21' / 6,40 m
PRE53022	8M0082545	22' / 6,70 m
PRE53023	8M0082546	23' / 7,00 m
PRE53024	8M0082547	24' / 7,30 m



3300C

Recorrido trabajo: 76 mm.  
Rosca 10-32"

Travel 3"  
Threaded 10-32"

Estensione: 76 mm  
Filetto 10-32"

Course: 76 mm.  
Fil 10-32"

REF	RO	
PRE3300C05	8M0082577	5' / 1,50 m
PRE3300C06	8M0082578	6' / 1,80 m
PRE3300C07	8M0082579	7' / 2,10 m
PRE3300C08	8M0082580	8' / 2,45 m
PRE3300C09	8M0082581	9' / 2,75 m
PRE3300C10	8M0082582	10' / 3,05 m
PRE3300C11	8M0082583	11' / 3,35 m
PRE3300C12	8M0082584	12' / 3,65 m
PRE3300C13	8M0082585	13' / 3,95 m
PRE3300C14	8M0082586	14' / 4,25 m
PRE3300C15	8M0082587	15' / 4,60 m
PRE3300C16	8M0082588	16' / 4,90 m
PRE3300C17	8M0082589	17' / 5,20 m
PRE3300C18	8M0082590	18' / 5,50 m
PRE3300C19	8M0082591	19' / 5,80 m
PRE3300C20	8M0082592	20' / 6,10 m
PRE3300C21	8M0082593	21' / 6,40 m
PRE3300C22	8M0082594	22' / 6,70 m
PRE3300C23	8M0082595	23' / 7,00 m
PRE3300C24	8M0082596	24' / 7,30 m

REF	RO	
PRE3300C25	8M0082597	25' / 7,60 m
PRE3300C26	8M0082598	26' / 7,90 m
PRE3300C27	8M0082599	27' / 8,25 m
PRE3300C28	8M0082600	28' / 8,55 m
PRE3300C29	8M0082601	29' / 8,85 m
PRE3300C30	8M0082602	30' / 9,15 m
PRE3300C31	8M0082603	31' / 9,50 m
PRE3300C32		32' / 9,75 m
PRE3300C33		33' / 10,00 m
PRE3300C34	8M0082604	34' / 10,35 m
PRE3300C35		35' / 10,65 m
PRE3300C36	8M0082605	36' / 11,00 m
PRE3300C38	8M0082606	38' / 11,50 m
PRE3300C40		40' / 12,10 m
PRE3300C42		42' / 12,70 m
PRE3300C44		44' / 13,30 m
PRE3300C46		46' / 14,00 m
PRE3300C48		48' / 14,50 m
PRE3300C50		50' / 15,00 m

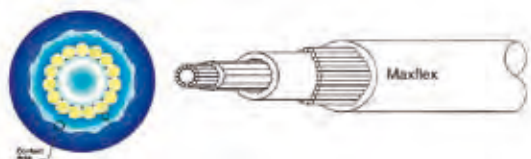

REF
PRE30107
PRE30212



PRE30107





PRE30212

**ACTUADOR CAMBIO ELECTRONICO**

**DIGITAL SHIFT ACTUATOR**

**ATTUATORE DEL CAMBIO**

**ACTIONNEUR DE CHANGEMENT**

REF	OEM		
REC879194T46	879194T46	3.0, 8.1, 8.2 496MAG, 5.0, 5.7, 6.2, 4.5	TDI 4.2 CMD QSD 2.0 CMD QSD 2.8 CMD QSD 4.2 2.0LEI/ES



new

**EJE CABLE CAMBIO SUPERIOR**

**UPPER SHIFT SHAFT**

**ALBERINO SUPERIORE CAMBIO**

**ARBRE SUPERIEUR**

REF	OEM	
REC45589A3	45589A3	MC-1/R/MR/Alpha One



REF	OEM	
REC816685	816685	Alpha One Gen II



REF	OEM	
REC12711	12711	Bravo I, II & III



**EJE CABLE CAMBIO INTERMEDIO**

**INTERMEDIATE SHIFT SHAFT**

**ALBERINO INTERMEDIO CAMBIO**

**ARBRE INTERMEDIAIRE DE CHANGEMENT**

REF	OEM	
REC621041	621041	MC-1/R/MR/Alpha One



**TORNILLO**

**SCREW**

**VITE**

**VIS**

REF	OEM	
REC10-45590	10-45590	MC-1 / R / MR
REC10-31700	10-31700	Alpha One / Gen II



REC10-45590



REC10-31700

**PASADOR**

**PIN**

**SPINOTTO**

**PIN**

REF	OEM	
REC45518A3	45518A3	MC-1 / R / MR Alpha One / Gen II



**KIT CAMBIO**

**SHIFT LEVER KIT**

**KIT CAMBIO**

**KIT CHANGEMENT**

REF	OEM	
REC45518T1	45518T1	MC-1/R/MR Alpha One / Gen II



**ACOPLE CABLE**

**CABLE SLIDE**

**ACCOPPIO CAVO**

**KIT ATTACHE CABLE**

REF	OEM	
REC8507522	8507522	MC-1 / R / MR Alpha One / Gen II



**KIT RETÉN**

**SEAL KIT**

**KIT TENUTE**

**KIT JOINTS D'HUILE**

REF	OEM	
REC23-806036A1	23-806036A1	Alpha One Gen II (F094775+)



REF	OEM	
REC23-861209A1	23-861209A1	Bravo I, II & III



REF	OEM	
REC23-805041A2	23-805041A2	MC-1 / R/ MR Alpha One / Gen II



**GUÍA CABLE**

**CABLE GUIDE**

**GUIDA CAVO**

**GUIDE CÂBLE**

	REF	OEM
KIT	REC02644	
ANCLAJE CABLE CABLE ANCHOR	REC43436	43436
FERMA CAVO ANCORAGE CABLE TORNILLO SCREW VITE VIS	REC10-20518	10-20518



**SOPORTE MOTOR**

**ENGINE MOUNT SCREW**

**SUPPORTI MOTORE**

**SUPPORT MOTEUR**

REF	OEM	
GS38105	814263A1	19 mm = 3/4"
GS38122	35852	16 mm = 5/8"



**ACOPLAMIENTOS MOTOR**

**ENGINE COUPLER ASSEMBLIES**

**ACCOPPIAMENTO MOTORE**

**ACCOUPLLEMENT MOTEUR**

REF	OEM	
REC69354A2	69354A2	470, 485 (42208730-6218036) (1976-82)



REF	OEM	
REC861523A9	861523A9	5.7, 7.4, 454 Magnum Et 502 BRAVO



REF	OEM	
REC97432A2	97432A2	165, 170, 470, 180, 190, 488, 3.7LX, 3.7L (6170297+) (1983-89)



REF	OEM	
REC59826A3	59826A3	FORD



Se usa en todos los Chevy antiguos en los que el retén trasero del cigüeñal es de dos piezas.

Used on all older Chevy engines with 2 piece rear main seals.

Si usa in tutti i Chevy vecchio con paraolio posteriore in 2 pz. 4 cil V6 e V8.

Utilisé sur toutes les anciennes Chevy où le joint arrière du vilebrequin est en deux parties.

REF	OEM	
REC76850A2	76850A2	GM MR / ALPHA / BRAVO



Utilizado al reemplazar V6 o V8, 2 piezas de retén trasero con perno de cigüeñal de 3 1/2", retén trasero de 1 pieza con perno de 3".

Used when replacing V6 or V8, 2 pieces rear main seal with 3 1/2" crankshaft bolt pattern to a newer 1 piece rear main seal engine with 3" bolt pattern.

Utilizzato per sostituire V6 o V8, paraolio posteriore in 2 pezzi con perno dell'albero motore con 3 1/2", perno posteriore de 1 pezzo da 3".

Utilisé lors du remplacement d'un V6 ou d'un V8, support arrière en 2 pièces avec boulon de vilebrequin de 3 1/2", support arrière en 1 pièce avec boulon de 3".

REF	OEM	
REC14505A2	14505A2	V6, V8



REF	OEM	
REC18643A7	18643A7	V6 Et V8 Con volante grande 14" For engines with 14" flywheel Con volano grande 14" Avec volant grand 14"



REF	OEM	
REC12632A7	12632A7	4L Con volante pequeño 12 3/4" For engines with 12 3/4" flywheel Con volano piccolo 12 3/4" Avec volant petit 12 3/4"



## SILEMBLOCK

REF	OEM				
REC23-99322	23-99322	ESPACIADOR	SPACER	DISTANZIALE	CALE
REC23-99299	23-99299	ESPACIADOR	SPACER	DISTANZIALE	CALE
REC12-32834	12-32834	ARANDELA FIBRA	FIBRE WASHER	RONDELLA FIBRA	RONDELLE FIBRE
REC12-35777	12-35777	ARANDELA	WASHER	RONDELLA	RONDELLE
REC10-97934	10-97934	TORNILLO	SCREW	VITE	VIS
REC11-863332	11-863332	CIERRE	LOCK	CHIUSSURA	ÉCROU
REC13-33734	13-33734	MUELLE	SPRING	MOLLA	RESSORT



## KITS SILEMBLOCK

REF	OEM
REC865329A02	865329A02



REF	OEM
REC10-97934A1	10-97934A1



REF	OEM
REC21811	





# POWER TRIM

120-140-165-228-250-260-470-485-888-898

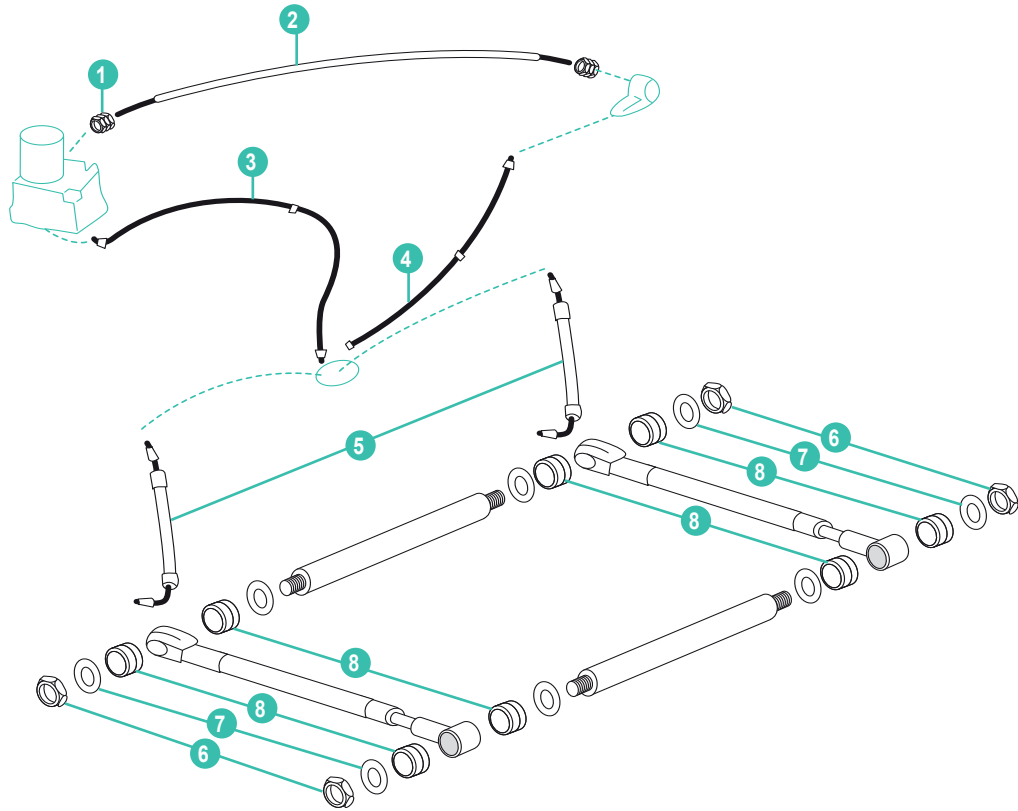

	REF	OEM				
1	RM22-49718	22-49718	TUERCA TUBO	NUT HOSE	DADO TUBO	ÉCROU
2	REC32-58432A2	32-58432A2	LATIGUILLO TRIM (V8)	TRIM HOSE ASSEMBLY (V8)	TUBO TRIM (V8)	FLEXIBLE DE VÉRIN DE TRIM (V8)
3	REC32-55816	33-55816	LATIGUILLO TRIM (INLINE)	TRIM HOSE (INLINE)	TUBO TRIM (INLINE)	FLEXIBLE DE VÉRIN DE TRIM (INLINE)
	REC32-59841	32-59841	LATIGUILLO TRIM (Conector --> bomba) V8	TRIM HOSE (Connector --> pump) V8	TUBO TRIM (Connettore --> pompa) V8	FLEXIBLE DE VÉRIN DE TRIM (Conecteur --> pompe) V8
4	REC32-59842	32-59842	LATIGUILLO TRIM	TRIM HOSE	TUBO TRIM	FLEXIBLE DE VÉRIN DE TRIM
5	REC32-86036	32-86036	LATIGUILLO TRIM	TRIM HOSE	TUBO TRIM	FLEXIBLE DE VÉRIN DE TRIM
6	REC11-862903	82671013	TUERCA ACERO INOX	LOCK NUT	DADO ACCIAIO INOX	ÉCROU INOX
7	REC12-46765	12-46765	ARANDELA	WASHER	RONDELLA	RONDELLE
8	REC23-89574	23-89574	ADAPTADOR GOMA	POWER TRIM RAM BUSHING	ADATTATORE IN GOMMA	BAGUE POWER TRIM
9	REC21990		KIT REPARACIÓN CILINDRO POWER TRIM 120, 140, 160, 165, 888, 898, 228, 225-S, 233, 250, 260, 470, 485	POWER TRIM CYLINDER SERVICE KIT 120, 140, 160, 165, 888, 898, 228, 225-S, 233, 250, 260, 470, 485	KIT RIPARAZIONE CILINDRO POWER TRIM 120, 140, 160, 165, 888, 898, 228, 225-S, 233, 250, 260, 470, 485	KIT REPARATION VERIN DE TRIM 120, 140, 160, 165, 888, 898, 228, 225-S, 233, 250, 260, 470, 485
10	REC21390		KIT EJE SUJECCIÓN POWER TRIM para colas antiguas con gruesos pequeños en el eje de sujección delantero. MC1 120-260	POWER TRIM RAM BUSHING KIT for front anchor pin on early mercruisers with small rubber bushings. MC1 120-260	KIT POWER TRIM. per vecchie piedi con piccoli spessori sull'asse di fissaggio anteriore MC1 120-260	KIT AXE VERIN DE TRIM, pour les vieilles embases avec de petites épaisseurs sur l'essieu avant. MC1 120-260
	REC21310					

R/MR/ALPHA ONE (1983-90)



REF  
REC8M0080805



REF  
REC87399A2



REF  
REC88035

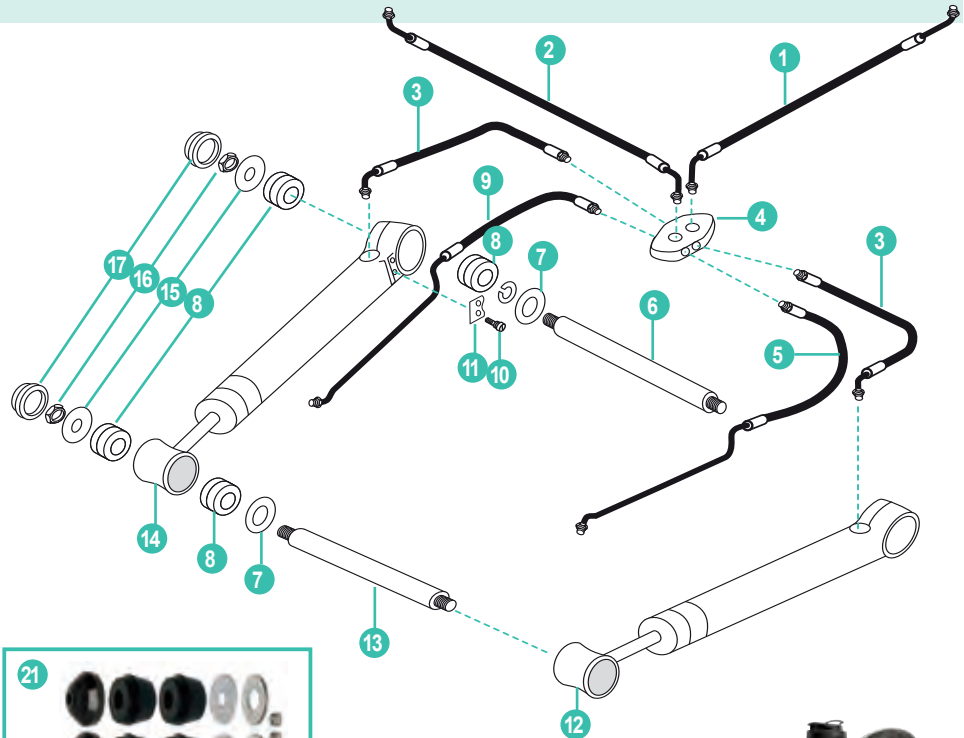

EJE  
RAM  
ASSE  
ARBRE  
REF  
REC21380 23 cm  
REC21370 30 cm



	REF	OEM				
1	REC32-861128	32-861128	LATIGUILLO TRIM (-OW099999)	TRIM HOSE (-OW099999)	TUBO TRIM (-OW099999)	FLEXIBLE DE TRIM (-OW099999)
2	REC32-861127	32-861127	LATIGUILLO TRIM (-OW099999)	TRIM HOSE (-OW099999)	TUBO TRIM (-OW099999)	FLEXIBLE DE TRIM (-OW099999)
3	REC32-99904	32-99904Q	LATIGUILLO TRIM	TRIM HOSE	TUBO TRIM	FLEXIBLE DE TRIM
4	REC8M0080805	8M0080805	KIT CONECTOR	TRIM CONNECTOR KIT	KIT CONNETTORE	KIT CONNECTEUR
5	REC32-864589	32-864589	LATIGUILLO PARA REC98704A3	TRIM HOSE FOR REC98704A3	TUBO TRIM PER REC98704A3	FLEXIBLE DE TRIM pour REC98704A3
6	REC32-864960	32-864960	LATIGUILLO PARA REC14034A3	TRIM HOSE FOR REC14034A3	TUBO TRIM PER REC14034A3	FLEXIBLE DE TRIM pour REC14034A3
7	REC17-14873A1	17-14873A1	KIT EJE SUJECCION (30 cm)	RAM BUSHING KIT (30 cm)	KIT ASSE (30 cm)	KIT ARBRE FIXATION VERIN (30 cm)
8	REC12-85058	12-85058	ARANDELA	WASHER	RONDELLA	RONDELLE
9	REC23-99291	23-99291T	ADAPTADOR GOMA	BALL GEAR NUT	ADATTATORE IN GOMMA	BAGUE
10	REC32-864588	32-864588	LATIGUILLO para REC98703A3	TRIM HOSE for REC98703A3	TUBO TRIM per REC98703A3	FLEXIBLE DE TRIM pour REC98704A3
11	REC32-864959	32-864959	LATIGUILLO para REC14035A3	TRIM HOSE for REC14035A3	TUBO TRIM per REC14035A3	FLEXIBLE DE TRIM pour REC14034A3
12	REC10-85486	10-85486	TORNILLO	SCREW	VITE	VIS
13	REC85060	85060	SUJECCIÓN TUBO	PLATE	SUPPORTO TUBO	PLAQUE SUPPORT
14	REC98704A3	98704A3	BRAZO TRIM ESTRIBOR (395 mm)	TRIM CYLINDER STBD (395 mm)	PISTONE TRIM TRIBORDO (395 mm)	VERIN DE TRIM TRIBORD (395 mm)
15	REC14034A3	14034A3	BRAZO TRIM ESTRIBOR (411 mm) Negro	TRIM CYLINDER STBD (411 mm) Black	PISTONE TRIM TRIBORDO (411 mm) Nero	VERIN DE TRIM TRIBORD (411 mm) Noir
16	REC17-14872A1	17-14872A1	KIT EJE SUJECCION (23 cm)	RAM BUSHING KIT (23 cm)	KIT ASSE SOGGEZIONE (23 cm)	KIT ARBRE FIXATION (23 cm)
17	REC98703A3	98703A3	BRAZO TRIM BABOR (395 mm)	TRIM CYLINDER PORT (395 mm)	PISTONE TRIM BABORDO (395 mm)	VERIN DE TRIM BABORD (395 mm)
18	REC14035A3	14035A3	BRAZO TRIM BABOR (411 mm) Negro	TRIM CYLINDER PORT (411 mm) Black	PISTONE TRIM BABORDO (411 mm) Nero	VERIN DE TRIM BABORD (411 mm) Noir
19	REC12-44163	12-44163	ARANDELA	WASHER	RONDELLA	RONDELLE
20	REC11-34933	11-859116	TUERCA ACERO INOX	LOCK NUT	DADO ACCIAIO INOX	ÉCROU INOX
21	REC19-14842	19-14842	TAPA PLÁSTICO	CAP	COPERCHIO IN PLASTICA	COUVERCLE PLASTIQUE
22	REC8M0080805	8M0080805	KIT CONECTOR TRIM	TRIM CONNECTOR KIT	KIT CONNETTORE TRIM	KIT CONNECTEUR TRIM
23	REC87399A2	87399A2	KIT REPARACIÓN TRIM (Alpha one Gen I)	POWER TRIM CYLINDER OVERHAUL KIT (Alpha one Gen I)	KIT RIPARAZIONE CILINDRO (Alpha one Gen I)	KIT REPARACION TRIM (Alpha one Gen I)
24	REC88035	88035	TAPON CILINDRO POWER TRIM Ø 52,8 mm (EXT)	POWER TRIM RAM END CAP Ø 52,8 mm (EXT)	TAPPO CILINDRO POWER TRIM Ø 52,8 mm (EXT)	COUVERCLE VERIN DE TRIM Ø Ext. 52,8 mm
25	REC21380	17-14872A1	KIT EJE SUJECCION para colas con gruesos grandes en ejes de sujeción	POWER TRIM RAM BUSHING KIT for rear anchor pin with large rubber bushings	KIT ASSE POWER TRIM per code con grandi spessori sugli alberi	KIT D'ARBRE DE SERRAGE pour les embases de grandes épaisseurs sur les arbres de serrage

Para saber la referencia del pistón debemos revisar el nº grabado en el brazo      Number on cylinder must be checked in order to know piston reference      Per sapere il codice del pistone bisogna verificare il nº stampigliato.      Pour connaître la référence du piston, il faut vérifier le numéro gravé sur le bras.

# ALPHA ONE GEN II (1991+)

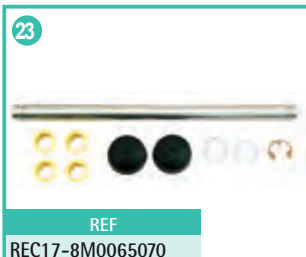
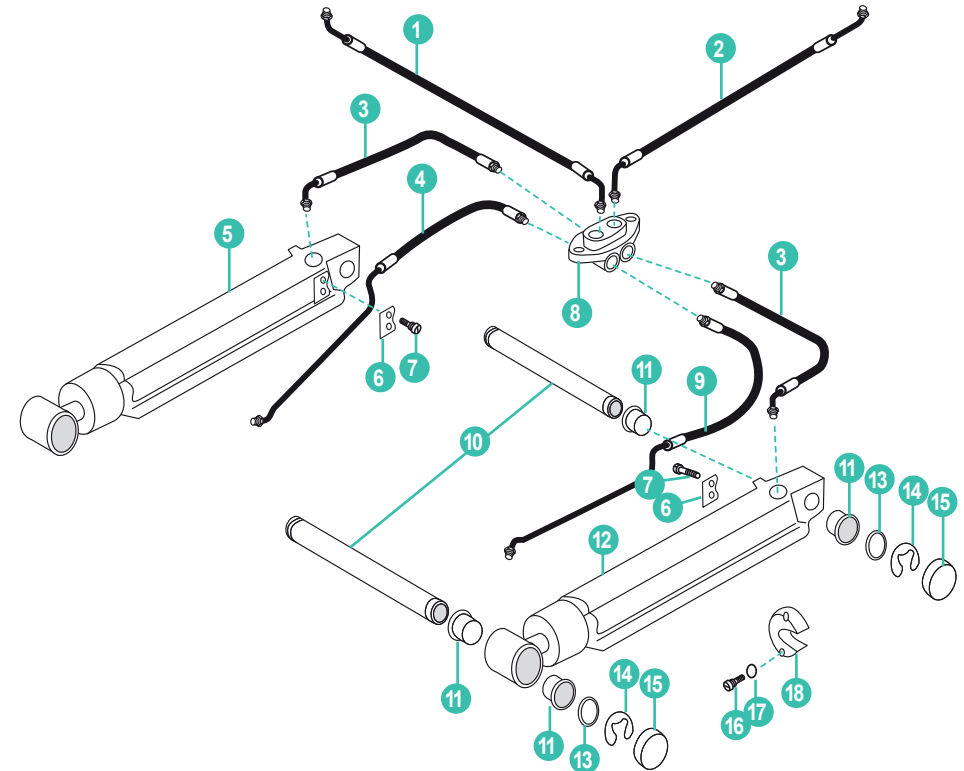

	REF	OEM				
1	REC32-861127	32-861127	LATIGUILLO TRIM (-OW099999) Negro	TRIM HOSE (-OW099999) Black	TUBO TRIM (-OW099999) Nero	FLEXIBLE DE TRIM (-OW099999) Noir
2	REC32-861128	32-861128	LATIGUILLO TRIM (-OW099999) gris	TRIM HOSE (-OW099999) Grey	TUBO TRIM (-OW099999) Grigio	FLEXIBLE DE TRIM (-OW099999) gris
3	REC32-99904	32-999040	LATIGUILLO TRIM	TRIM HOSE	TUBO TRIM	FLEXIBLE DE TRIM
4	REC32-864959	32-864959	LATIGUILLO TRIM	TRIM HOSE	TUBO TRIM	FLEXIBLE DE TRIM
5	REC815935A7	815935A7	CILINDRO TRIM BABOR	TRIM CYLINDER PORT	CILINDRO TRIM SINISTRO	VERIN DE TRIM BABORD
6	REC85060	85060	SUJECCION TUBO	PLATE	SUPPORTO TUBO	PLAQUE SUPPORT
7	REC10-85486	10-85486	TORNILLO (.250 -20x.380)	SCREW (.250 -20x.380)	VITE (.250 -20x.380)	VIS (.250 -20x.380)
8	REC8M0080805	8M0080805	KIT CONECTOR	TRIM CONNECTOR KIT	KIT CONNETTORE TRIM	KIT CONNECTEUR TRIM
9	REC32-864960	32-864960	LATIGUILLO TRIM	TRIM HOSE	TUBO TRIM	FLEXIBLE DE TRIM
10	REC17-815953A01	17-815953A01	EJE	UPPER SHIFT SHAFT	ASSE	ARBRE
11	REC23-8159501	23-8159501	CASQUILLO	POWER TRIM RAM BUSHING	BOCCOLA	BAGUE DE VÉRIN
12	REC815954A7	815954A7	CILINDRO TRIM ESTRIBOR	TRIM CYLINDER STBD	CILINDRO TRIM DESTRO	VERIN DE TRIM TRIBORD
13	REC12-815952	12-815952	ARANDELA	WASHER	RONDELLA	RONDELLE
14	REC53-815949	53-815949	CIERRE METÁLICO	E-RING	CHIUSURA METALLICA	ÉCROU METAL
15	REC19-815951	19-815951	TAPA PLÁSTICO	PLASTIC CAP	COPERCHIO IN PLASTICA	COUVERCLE PLASTIQUE
16	REC10-806290	10-806290	TORNILLO	SCREW	VITE	VIS
17	REC304454	13-69432	ARANDELA	WASHER	RONDELLA	RONDELLE
18	CM806189	806189Q1	ÁNODO ZN	ZN ANODE	ANODO ZN	ANODE ZN
	CM806189A	806189Q1	ÁNODO AL	AL ANODE	ANODO AL	ANODE AL
19	REC8M0080805	8M0080805	KIT CONECTOR TRIM	TRIM CONNECTOR KIT	KIT CONNETTORE TRIM	K KIT CONNECTEUR TRIM
20	REC806191T	806191T	TAPÓN CILINDRO POWER TRIM Ø 48 MM (EXT)	POWER TRIM RAM END CAP Ø 48 MM (EXT)	TAPPO CILINDRO POWER TRIM Ø 48 MM (EXT)	COUVERCLE VERIN DE TRIM Ø Ext. 48 mm
21	REC87399A3	87399A3	KIT REPARACION TRIM	POWER TRIM CYLINDER OVERHAUL KIT	KIT RIPARAZIONE TRIM	KIT REPARACION TRIM
22	REC25-87400A2	25-87400A2	KIT RETENES	POWER TRIM SEAL KIT	KIT TENUTE	KIT JOINTS D'HUILE
23	REC17-8M0065070		KIT EJE SUJECCION	POWER TRIM RAM BUSHING KIT	KIT SUPPORTO	KIT D'ARBRE DE SERRAGE

BRAVO



REF  
REC8M0080805



REF  
REC806191T

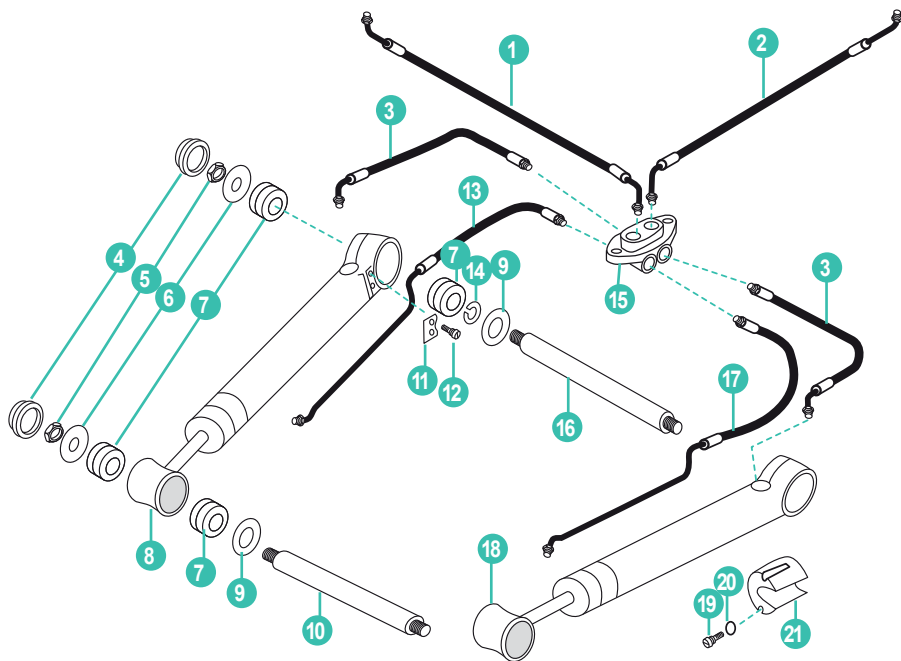

REF  
REC87399A2



REF  
REC25-87400A2



REF  
REC14-44166T1



REF  
REC21920

	REF	OEM				
1	REC32-861127	32-861127	LATIGUILLO (-OW099999) Negro	TRIM HOSE (-OW099999) Black	TUBO TRIM (-OW099999) Nero	FLEXIBLE DE TRIM (-OW099999) Noir
2	REC32-861128	32-861128	LATIGUILLO (-OW099999) gris	TRIM HOSE (-OW099999) Grey	TUBO TRIM (-OW099999) Grigio	FLEXIBLE DE TRIM (-OW099999) gris
3	REC32-99904	32-99904Q	LATIGUILLO TRIM	TRIM HOSE	TUBO TRIM	FLEXIBLE DE TRIM
4	REC19-14842	19-14842	TAPA PLÁSTICO	PLASTIC CAP	COPERCHIO IN PLASTICA	COUVERCLE PLASTIQUE
5	REC11-34933	11-859116	TUERCA INOX	LOCK NUT	DADO INOX	ÉCROU INOX
6	REC12-44163	12-44163	ARANDELA	WASHER	RONDELLA	RONDELLE
7	REC23-807073	23-807073	ADAPTADOR GOMA P.T.	P.T. RAM BUSHING	ADATTATORE GOMMA	BAGUE POWER TRIM
8	REC98703A26	98703A26	PISTÓN TRIM BABOR	TRIM CYLINDER PORT	PISTONE TRIM SINISTRO	VERIN DE TRIM BABORD
9	REC12-44164	12-44164	ARANDELA	WASHER	RONDELLA	RONDELLE
10	REC17-44166	17-44166	EJE SUJECCIÓN TRIM	ANCHOR PIN	ASSE TRIM	ARBRE
11	REC85060	85060	SUJECCIÓN TUBO	PLATE	SUPPORTO TUBO	PLAQUE SUPPORT
12	REC10-85486	10-85486	TORNILLO	SCREW	VITE	VIS
13	REC32-864588	32-864588	LATIGUILLO TRIM	TRIM HOSE	TUBO TRIM	FLEXIBLE DE TRIM
14	REC53-805272	53-805272	ARO RETENEDOR	RETAINING RING	ANELLO BLOCCANTE	CLIPS
15	REC8M0080805	8M0080805	KIT CONECTOR	TRIM CONNECTOR KIT	KIT CONNETTORE	KIT CONNECTEUR
16	REC17-44167A1	17-44167A1	EJE SUJECCIÓN TRIM	ANCHOR PIN	ASSE SUPPORTO TUBO	ARBRE FIXATION VERIN DE TRIM
17	REC32-864589	32-864589	LATIGUILLO TRIM	TRIM HOSE	TUBO TRIM	FLEXIBLE DE TRIM
18	REC98704A26	98704A26	PISTÓN TRIM ESTRIBOR	TRIM CYLINDER STBD	PISTONE TRIM DESTRO	VERIN DE TRIM TRIBORD
19	REC10-806290	10-806290	TORNILLO	SCREW	VITE	VIS
20	REC304454	13-69432	ARANDELA	WASHER	RONDELLA	RONDELLE
21	CM806190 CM806190A	806190A1 806190A1	ÁNODO ZN ÁNODO AL	ZN ANODE AL ANODE	ANODO ZN ANODO AL	ANODE ZN ANODE AL
22	REC8M0080805	8M0080805	KIT CONECTOR TRIM	TRIM CONNECTOR KIT	KIT CONNETTORE TRIM	KIT CONNECTEUR
23	REC806191T	806191T	TAPÓN CILINDRO Ø 48 MM (EXT)	RAM END CAP Ø 48 MM (EXT)	TAPPO CILINDRO Ø 48mm (EXT)	NEZ DE VERIN Ø 48mm (ext.)
24	REC87399A2	87399A2	KIT REPARACIÓN TRIM	POWER TRIM CYLINDER OVERHAUL KIT	KIT RIPARAZIONE TRIM	KIT REPARATION VERIN
25	REC25-87400A2	25-87400A2	KIT RETENES	POWER TRIM SEAL KIT	KIT TENUTE	KIT JOINTS DE VÉRIN
26	REC14-44166T1	17-44166T1	KIT EJE SUJECCIÓN TRASERO	POWER TRIM RAM BUSHING KIT (REAR)	KIT ASSE POSTERIORE	KIT ARBRE FIXATION VERIN DE TRIM (arrière)
26	REC21920		KIT EJE SUJECCIÓN DELANTERO	POWER TRIM RAM BUSHING KIT (FRONT)	KIT ASSE ANTERIORE	KIT AXE VERIN DE TRIM (front)





**LATIGUILLOS POWER TRIM**



**POWER TRIM HOSES**

**TUBI POWER TRIM**

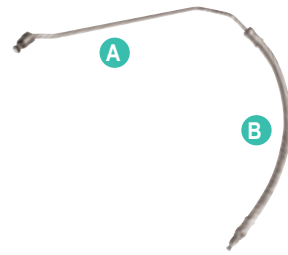

**FLEXIBLE DE POWER TRIM**

REF	OEM			
REC32-864960	32-99902-1 32-864960 32-99902	1/8"	11 1/2" + 14"	MCM 120-260 Et BRAVO
REC32-864589	32-864589			





REF	OEM			
REC32-864959	32-99903-1 32-864959	1/8"	11 1/2" + 14"	MCM 120-260 Et BRAVO
REC32-864588	32-99903 32-864588			1/8"





REF	OEM			
REC32-861127	32-861127 32-95858	■	46"	R / MR / ALPHA GEN II BRAVO I, II, III / BRAVO X, XR, XZ (-0W099999)
REC32-861128	32-861128 32-95859	■	51"	sin conectores rápidos without quick connect fittings senza connettori rapidi sans connecteurs rapides



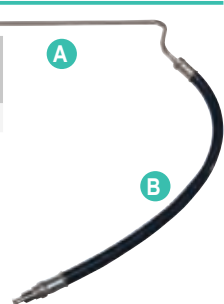

REF	OEM			
REC32-87234	32-87234	1/8"	11 1/2" + 14"	



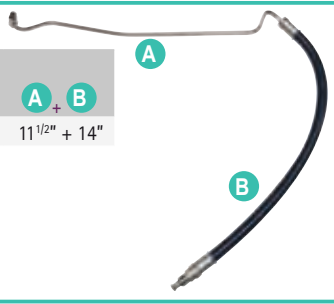

REF	OEM			
REC32-87235	32-87235	1/8"	11 1/2" + 14"	



REF	OEM		
REC32-86036	32-86036 32-86036Q	1/8"	14"



REF	OEM		
REC32-99904	32-99904	1/8"	15"





REF	OEM		
REC32-55816	32-55816	1/8"	21"



REF	OEM		
REC32-59842	32-59842	1/8"	32"



REF	OEM		
REC32-59841	32-59841	1/8"	51"

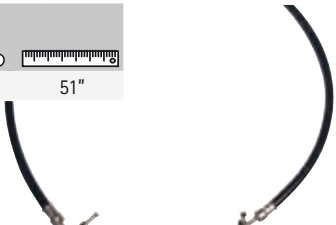

REF	OEM
REC32-58432A2	32-58432A2



new

EXTRACTOR TAPONES DE TRIM

TRIM PLUGS EXTRACTOR

ESTRATTORE PER TAPPI DI TRIM

KIT EXTRACTEUR

REF	
RECTOOLTRIMKIT	RECTOOLTRIM1 + RECTOOLTRIM2 + RECTOOLTRIM 3



REF					
RECTOOLTRIM1	1/2" + RECPIN4	+ RECPIN4.5	38 mm	Mercruiser Alpha One Et Bravo Trim Cylinders	
RECTOOLTRIM2	1/2" + RECPIN4	+ RECPIN4.5	32 mm		
RECTOOLTRIM3	1/2" + RECPIN6		35 mm		

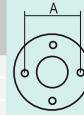

KITS DE RECAMBIO

Los pines de repuesto no tienen garantía.

SPARE KITS

Replacement pins are not guaranteed.

KIT DI RICAMBIO

I perni di ricambio non sono garantiti.

KIT DE RECHANGE

Les pins de remplacement ne sont pas garantis

REF	
RECPIN4	3 PIN x 4 mm
RECPIN4.5	3 PIN x 4.5 mm
RECPIN6	3 PIN x 6 mm



HERRAMIENTAS

TOOLS

ATTREZZI

OUTILS

EXTRACTOR COJINETES Y HELICES

PROP AND BEARING PULLER

ESTRATTORE CUSCINETTI E ELICHE

EXTRACTEUR DE ROUEMENTS ET D'HELICE

REF
REC90095

**RECMAR®**



Para hélices y cojinetes antiguos  
For prop and old style bearing carrier.  
Per eliche e cuscinetti vecchi.  
Pour hélices et roulements anciens



Para cojinetes modernos  
For new style bearing carrier.  
Per cuscinetti moderni.  
Pour roulements récents.



EXTRACTOR COJINETES

BEARING PULLER

ESTRATTORE CUSCINETTI

EXTRACTEUR DE ROUEMENTS

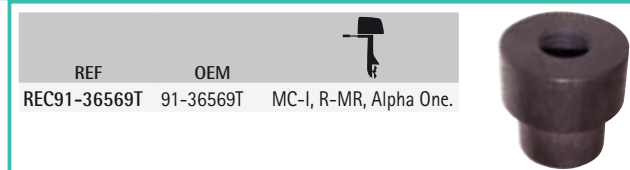

EXTRACTOR PIÑONES Y COJINETES

UNIVERSAL PULLER PLATE

ESTRATTORE PIGNONE E CUSCINETTI

EXTRACTEUR PIGNONS ET ROUEMENTS

REF	PIÑONES BEARINGS PIGNONE PIGNONS
REC91-00001	30-50 mm / 1 <sup>1</sup> / <sub>4</sub> " - 2 <sup>1</sup> / <sub>4</sub> "
REC91-00002	50-75 mm / 2 <sup>1</sup> / <sub>4</sub> " - 3 <sup>1</sup> / <sub>2</sub> "
REC91-37241	75-105 mm / 3" - 4 <sup>1</sup> / <sub>2</sub> "



**RECMAR®**

**KIT HERRAMIENTAS PARA COLAS**

**GEAR CASE TOOL KIT**

**KTI ATTREZZI PIEDI**

**KIT OUTILS POUR EMBASES**

REF  
RM91-31229A7  
**RECMAR**



**LLAVE TUERCA DIÁBOLO**

**BEARING CARRIER RETAINER WRENCH**

**CHIAVE PER CUSCINETTO**

**CLE POUR ECROU DE DIABOLO**

REF  
REC91-61069T  
**RECMAR**

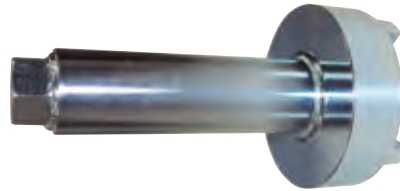

**KIT LLAVE HÉLICE**

**PROP WRENCH KIT**

**KIT CHIAVE ELICA**

**CLE POUR ECROU D'HELICE**

REF  
REC91-859046Q4 1 1/16" 75 - 300 HP



FLOTANTE | FLOATING | GALLEGGIANTE | FLOTTANTE  
REF  
REC91-859046Q3 15/16" 30, 40, 50 & 60 HP

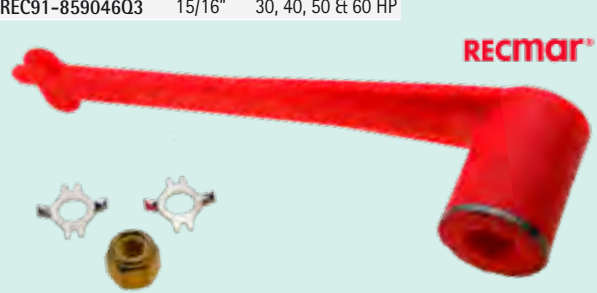

**new**

**LLAVE TUERCA EJE VERTICAL**

**PINION NUT ADAPTOR KIT**

**CHIAVE DADO ASSE VERTICALE**

**CLE POUR ARBRE VERTICAL**

Incluye un adaptador eje. Sostiene la tuerca del piñón cuando se está sacando el piñón y el eje en las colas.

Holds pinion nut when removing pinion gear and drive shaft on drive units. Comes with drive shaft adaptor.

Incluye un adattatore albero. Tenendo il dado del pignone quando si rimuove la ruota dentata e l'albero nel piede.

Inclus un adaptateur d'arbre. Maintient l'écrou du pignon lors de la dépose du pignon et de l'axe sur les embases.

REF  
REC91-61067A04  
**RECMAR**



Para montaje y desmontaje del retenedor y cojinete superior en colas.

Removes and installs threaded bearing retainer on stern drives.

Per il montaggio e lo smontaggio del fermo di ritengo e del cuscinetto superiore dei piedi.

Pour le montage et le démontage de la retenue et du palier supérieur dans les embases

REF  
REC91-43506T

OEM  
91-43506T



**EXTRACTOR POLEA BOMBA DE DIRECCIÓN**

**PULLEY REMOVER, DRIVE PUMP**

**RIMOZIONE PULEGGIA, POMPA STERZO**

**EXTRACTEUR DE POULIE POMPE DE DIRECTION**

REF  
REC91-25034



**new**

**LLAVE ESTRIDADO EJE**      **PROP SHAFT ADAPTOR**      **CHIAVE ASSE STRIATO**      **CLE POUR ARBRE D'HELICE**

Da una superficie de llave para girar el eje de la hélice en las colas.      Provides a wrench surface to turn the propeller.      Fornisce una superficie di chiave per ruotare l'asse del propulsore nel piede.      Fournit une surface de clé pour faire tourner l'arbre d'hélice sur les embases.

REF	OEM	
REC91-56775T	91-56775T	MC-I, R-MR, TRS, Alpha One Et Gene II.
REC91-61077T	91-61077T	



REC91-61077T



REC91-56775T

**EXPANSOR DE FUELLES**      **BELLOWS EXPANDER TOOL**      **ATTREZZO PER CUFFIE**      **OUTIL DE MONTAGE SOUFFLETS**

REF	OEM	
REC91-45497A1	91-45497A1	MC-1/R/MR Alpha One/Alpha One Gen II Bravo, Et Blackhawk



**ÚTIL INSTALACIÓN ANILLO DE FUELLE**      **BELLOWS RING INSTALLATION TOOL**      **STRUMENTO PER L'INSTAL DELL'ANELLO DEL SOFFIETTO**      **OUTIL D'INSTALLATION DE L'ANNE DE SOUFFLET**

REF	OEM	
REC91-818162	91-818162	Alpha Gen II Et Bravo



**LLAVE GALGADO PIÑONES**      **PINION GEAR SHIMMING TOOL**      **CHIAVE PER PIGNONI**      **CLE POUR PIGNONS**

Mide la altura del piñón en las colas MC-I, R-MR, Alpha One y Gene II      Measures pinion height of MC-I; R-MR; Alpha One; and Alpha One, Gen Two drive units.      Misurare l'altezza del pignone nel piede MC-I, R-MR, Alpha One e Gen II.      Mesure la hauteur du pignon sur les queues MC-I, R-MR, Alpha One et Gene II

REF	OEM
REC91-56048001	91-56048001
REC91-60523	91-60523
REC91-60526T	91-60526T

REC91-56048001



REC91-60526T



REC91-60523

**CENTRADOR MOTOR**      **ENGINE ALIGNMENT TOOL**      **CENTRATORE MOTORE**      **OUTIL D'ALIGNEMENT**

Centra el motor y la cola durante la instalación.      Aligns engine and drive unit during installation.      Centra il motore con il piede durante l'installazione      Centre le moteur et la queue pendant l'installation

REF	OEM
REC91-805475A1	91-805475A1



**LLAVE TORNILLO LATERAL TRANSOM**      **HINGE PIN TOOL**      **CHIAVE VITE LATERALE TRANSOM**      **OUTIL DE DÉMONTAGE DE PIVOT POUR EMBASE**

Instala y desinstala los tornillos laterales de las colas.      Removes and installs hinge pins from drive units.      Per tutti i piedi Mercuriser.      Installe et désinstalle les vis à queue latérales.

REF	OEM
REC91-78310	91-78310





**LLAVES PARA ELEMENTOS DEL CAMBIO**

**TOOLS FOR ELEMENTS TO DRIVESHAFT**

**CHIAVI PER GLI ELEMENTI DEL CAMBIO**

**ADAPTATEUR ARBRE DE TRANSMISSION**

Llave montaje y desmontaje casquillo sujeción tubo de agua.

Drive shaft adapter.

Chiave per smontare e montare la ghiera del tubo acqua.

Clé pour le montage et le démontage de la douille de fixation de la conduite d'eau.

REF	OEM	
REC91-43579	91-43579	Bravo I, II & III



Llave montaje retenes y casquillos eje cambio.

Driveshaft shimming tool.

Chiave per smontare paraolio e ghiera asse cambio.

Clé de montage des joints et des bagues de l'arbre de transmission.

REF	OEM	
RM91-17275A1	91-17275A1	Bravo I, II & III



Llave tuerca varilla cambio. Para montaje y desmontaje de las tuercas de la varilla cambio en las colas.

Shift shaft bushing tool. Removes and installs the shift shaft bushing in the gear case of drive units.

Chiave per il dado dell'asta del cambio. Per montare e smontare i dadi dell'asta del cambio sulle code.

Clé pour l'écrou de la tige de changement de vitesse. Pour le montage et le démontage des écrous de la tige de changement de vitesse sur les queues.

REF	OEM	
REC91-31107T	91-31107T	MC-I, R-MR, Alpha One.



Llave cable cambio. Para montaje y desmontaje de los cables de cambio en las colas.

Shift cable tool. Installs and removes drive shaft bearing retainer on drive units.

Chiave cavo cambio. Per installare e smontare i cavi cambio nei piedi.

Clé pour câble de changement de vitesse. Pour monter et démonter les câbles de changement de vitesse sur les queues.

REF	OEM	
REC91-12037	91-12037	MC-I, R-MR, Alpha One, Gen II.



Llave montaje casquillos eje cambio.

Bushing removal tool.

Chiave per montare ghiera asse cambio.

Clé de montage de la douille de l'arbre de transmission.

REF	OEM	
RM91-17273	91-17273	Bravo I, II & III



Llave extractora eje cambio.

Shift handle tool. F

Chiave estrattore asse cambio.

Clé d'extraction pour l'arbre de transmission.

REF	OEM	
RM91-17302	91-17302	Bravo I, II & III



**EXTRACTOR**

**PULLEY ROD**

**ESTRATTORE**

**EXTRACTEUR DE POULIE**

Para utilizar con las herramientas REC91-43579 y REC91-36569T para instalar y desmontar el cojinete

Used with REC91-43579 & REC91-36569T tools to install & remove pinion bearing.

Da utilizzare con gli strumenti REC91-43579 e REC91-36569T per installare e smontare il cuscinetto.

A utiliser avec les outils REC91-43579 et REC91-36569T pour installer et retirer le roulement

REF
REC91-31229



**LLAVE TUERCA CARDAN**

**BEARING RETAINER WRENCH**

**CHIAVE CARDANO**

**CLÉ POUR ÉCROU D'ARBRE**

REF	OEM	
REC91-17256	91-17256	MC-I, R-MR, Blackhawk, Alpha y Bravo.



REF	OEM	
REC90490	91-17257T 91-8053741	Bravo II Et Bravo III



**VACUÓMETRO DOBLE FUNCIÓN**

**PRESSURE / VACUUM TESTER**

**VACUOMETRO DOPPIA FUNZIONE**

**VACUOMETRE DOUBLE FONCTION**

Presión y vacío. Ideal para comprobar las unidades de transmisión, sensores, vst, etc.

Combination unit that does pressure and vacuum testing in one units. Recommended to test drives.

Pressione e sottovuoto. Ideale per il controllo dei piedi.

Unité combinée qui effectue des tests de pression et de vide. Recommandé pour tester les embases.

REF
REC55134



**PISTOLA DE ACEITE**

**BOTTLE GREASE PUMP**

**PISTOLA OLIO**

**PISTOLET POUR HUILE D'EMBASE**

Pistola para acoplar en los envases de botella de 1 L LUB11552 y LUB11564. Se suministra con kit de adaptación con válvula anti-retorno.

Lower unit quart pump. Complete with metal threaded filler fitting.

Pistola da accoppiare a bottiglie da 1 L LUB11552 e LUB11564. Si vende con kit di accoppiamento con valvola anti-ritorno.

Pistolet pour les bidons d'huile de 1 L LUB11552 et LUB11564. Vendu avec kit de couplage avec clapet anti-retour.

REF
REC55005



**ADAPTADOR PARA EMBASES RECLUBE**

**ADAPTOR FOR RECLUBE CONTAINERS**

**ADATTATORE PER CONTENITORI RECLUBE**

**ADAPTATEUR POUR CONTENEURS RECLUBE**

Para la pistola de aceite REC55005.

For REC55005 bottle grease pump.

Per pistola olio REC55005.

Pour le pistolet REC55005.

REF
REC55006



# SISTEMA DE PROPULSIÓN PROPULSION SYSTEM

# SISTEMA DI PROPULSIONE SYSTEME DE PROPULSION

HÉLICES ALUMINIO E INOXIDABLE DE 3 Y 4 PALAS	3 & 4 BLADE ALUMINIUM & SS PROPELLERS	ELICHE ALLUMINIO E INOX DA 3 E 4 PALE	HELICE ALUMINIUM ET INOX 3 ET 4 PALES
CÓDIGO DE REFERENCIAS	PART NO. CODING SYSTEM	SISTEMA DI CODICE	CODAGE DES REFERENCES
1. Mercury, Mariner 2. Johnson, Evinrude 3. Yamaha 4. Suzuki 5. Tohatsu 6. 7. 8. Volvo Penta 9. Rubex System	0.5, 6, 8 and 9.8 HP Group 1. A Group 2. B Group 3. C Group 4. D Group 5. E Group 6. F Group 7. VP (Std. Hub) 8. VP (Long Hub)	1. AL 2. Saturn (INOX   Stainless Steel) 3. New Saturn (INOX   Stainless Steel) 4. Titan (INOX   Stainless Steel) 5. HR Titan (INOX   Stainless Steel) 6. Scorpion (INOX   Stainless Steel) 7. Lexor (INOX   Stainless Steel)	1. 3R Rubber Hub 2. 3L Rubber Hub 3. 4R Rubber Hub 4. 4L Rubber Hub



## AMITA 3



Hélice de aluminio con núcleo de goma de gran resistencia.

Aluminum propeller with heavy duty rubber hub.

Eliche di alluminio con mozzi in gomma ad alta resistenza.

Hélice en aluminium avec moyeu en caoutchouc



## AMITA 4



Hélices de aluminio con núcleo de goma de gran resistencia. Van muy suaves a poca velocidad y hace el barco muy manejable con la mar picada.

Aluminum propeller with heavy duty rubber hub. Smoother low speed makes the offshore boating activity much easier.

Eliche di alluminio con mozzo in gomma ad alta resistenza. Molto morbido a bassa velocità e rende la barca molto maneggevole con mare cattivo.

Hélice en aluminium avec moyeu en caoutchouc. Permet d'aller doucement à basse vitesse et rende le bateau très maniable lorsque la mer est agitée



## LEXOR



Hélices de acero inoxidable. Gran diámetro del área de las palas para barcos pesados. Gran rendimiento en alta velocidad sin sacrificar las velocidades medias. Excelente ahorro de combustible.

Stainless steel propeller. Large diameter and blade area for big boat loads. Great high speed performance without sacrificing mid-range speeds. Excellent fuel economy.

Eliche di acciaio inox. Grande diametro delle pale per imbarcazioni pesanti. Grandi prestazioni ad alta velocità senza sacrificare velocità medie. Eccellente risparmio di carburante.

Hélice inox, grand diamètre pour bateaux lourds. Excellentes performances à grande vitesse sans sacrifier les vitesses moyennes. Excellente économie de carburant.



## NEW SATURN



Hélices de acero inoxidable. Ofrece buena aceleración y rendimiento. Tamaño más pequeño que ofrece un diámetro extragrande.

Stainless steel propeller. Offers good acceleration & all-round performance. Smaller pitch sizes offered in extra large diameter with increased blade area.

Eliche di acciaio inox. Buona accelerazione. Piccole dimensioni che offre un più grande diametro.

Hélice inox, offrant de bonnes accélérations et performances. Taille de pas réduite pour les modèles de grands diamètres avec une surface de pale plus importante.



## HR TITAN 3 PROP



Hélice de acero inoxidable. Alto rendimiento para cascos de alta velocidad. La inclinación de la hoja proporciona un excelente elevación de proa y aceleración. El diseño de copa grande aumenta la mordida y reduce el deslizamiento.

Stainless steel propeller. Performance prop for high speed planning hulls. High rake blade design provides excellent bow lift and acceleration. Heavy cup design increases bite and reduces slip.

Eliche in acciaio inox. Alte prestazioni per scafi ad alta velocità. Il passo della pala fornisce un'eccellente spinta e accelerazione. Il disegno aumenta le prestazioni.

Hélice en acier inoxydable. Hélice de performance pour les coques de planification à grande vitesse. La conception de la lame à haut râteau offre une excellente portance et accélération de l'arc. La conception lourde de la tasse augmente la morsure et réduit le glissement.



GUÍA DE HÉLICES CON NÚCLEO INTEGRADO		PROPELLERS APPLICATION WITH RUBBER HUB				GUIDA ELICHE CON MOZZO		GUIDE DES HELICES ET MOYEUX		
R.O. OEM	B	D	P	R	TIPO	AL		INOX STAINLESS STEEL		
						AMITA 3	AMITA 4	NEW SATURN	HR TITAN 3	LEXOR
48-78114A45	3	16	13	R	BLACK MAX	SOL1511-160-13		SOL1531-156-13		
48-78116A4	3	15 1/2	15	R	BLACK MAX		SOL1513-148-15	SOL1531-145-15		
48-832828A45	3	15	17	R	BLACK MAX	SOL1511-150-15	SOL1513-145-17	SOL1531-143-17		
48-832830A45	3	14 1/2	19	R	BLACK MAX	SOL1511-148-17	SOL1513-143-19	SOL1531-140-19		
48-832832A45	3	14 1/2	21	R	BLACK MAX	SOL1511-145-19	SOL1513-140-21	SOL1531-140-21		
48-832834A45	3	14	23	R	BLACK MAX	SOL1511-143-21	SOL1513-140-23	SOL1531-140-23		
48-78126A45	3	13 3/8	25	R	BLACK MAX	SOL1511-142-23		SOL1531-140-25		
48-831850A45	4	15	16	R	ALPHA 4		SOL1513-145-17			
48-834851A45	4	15	16	L	ALPHA 4		SOL1514-145-17			
48-834852A45	4	14 1/2	18	R	ALPHA 4		SOL1513-143-19			
48-834853A45	4	14 1/2	18	L	ALPHA 4		SOL1514-143-19			
48-834854A45	4	14	20	R	ALPHA 4		SOL1513-140-21			
48-834855A45	4	14	20	L	ALPHA 4		SOL1514-140-21			
48-16312A46	3	14 1/2	15	R	VENGEANCE			SOL1531-145-15		
48-16314A46	3	14 1/2	17	R	VENGEANCE			SOL1531-143-17	SOL1551-148-16	
48-16315A46	3	14 1/2	17	L	VENGEANCE			SOL1532-143-17	SOL1552-148-16	
48-16316A46	3	14	19	R	VENGEANCE			SOL1531-140-19	SOL1551-148-18	
48-16317A46	3	14	19	L	VENGEANCE			SOL1532-140-19	SOL1552-148-18	
48-16318A46	3	13 3/4	21	R	VENGEANCE			SOL1531-140-21	SOL1551-148-20	
48-16319A46	3	13 3/4	21	L	VENGEANCE			SOL1532-140-21	SOL1552-148-20	
48-16320A46	3	13 1/2	23	R	VENGEANCE			SOL1531-140-23	SOL1551-143-22	
48-16321A46	3	13 1/2	23	L	VENGEANCE			SOL1532-140-23	SOL1552-143-22	
48-16322A46	3	13 3/8	25	R	VENGEANCE			SOL1531-140-25	SOL1551-140-24	
48-16544A46	3	14	19	R	LASER II				SOL1551-148-19	
48-16543A46	3	14	19	L	LASER II				SOL1552-148-19	
48-16546A46	3	13 7/8	21	R	LASER II				SOL1551-145-21	
48-16545A46	3	13 7/8	21	L	LASER II				SOL1552-145-21	
48-16548A46	3	13 3/4	23	R	LASER II				SOL1551-143-22	
48-16547A46	3	13 3/4	23	L	LASER II				SOL1552-143-22	
48-16550A46	3	13 3/4	25	R	LASER II				SOL1551-140-24	
48-16549A46	3	13 3/4	25	L	LASER II				SOL1552-140-24	
48-826072A46	3	16	13	R	MIRAGE PLUS	SOL1511-160-13				
48-19838A46	3	15 3/4	15	R	MIRAGE PLUS	SOL1511-158-15				
48-19841A46	3	15 3/4	15	L	MIRAGE PLUS	SOL1512-158-15				
48-18278A46	3	15 1/2	17	R	MIRAGE PLUS	SOL1511-155-17		SOL1571-155-17		
48-90159A46	3	15 1/2	17	L	MIRAGE PLUS	SOL1512-155-17		SOL1572-155-17		
48-13700A46	3	15 1/4	19	R	MIRAGE PLUS	SOL1511-153-19		SOL1571-153-19		
48-13701A46	3	15 1/4	19	L	MIRAGE PLUS	SOL1512-153-19		SOL1572-153-19		
48-13702A46	3	13 3/4	21	R	MIRAGE PLUS	SOL1511-153-21		SOL1571-150-21		
48-13703A46	3	14 3/4	21	L	MIRAGE PLUS	SOL1512-153-21		SOL1572-150-21		
48-13704A46	3	14 5/8	23	R	MIRAGE PLUS	SOL1511-153-23		SOL1571-148-23		
48-13705A46	3	14 5/8	23	L	MIRAGE PLUS			SOL1572-148-23		
48-13706A46	3	14 1/2	25	R	MIRAGE PLUS			SOL1571-145-25		
48-13707A46	3	14 1/2	25	L	MIRAGE PLUS			SOL1572-145-25		
48-18610A40	3	19 1/4	15	R	ALUM	SOL1611-193-15		SOL1641-193-15		
48-18611A40	3	19 1/4	15	L	ALUM	SOL1612-193-15		SOL1642-193-15		
48-18612A40	3	18 3/4	17	R	ALUM	SOL1611-188-17		SOL1641-188-17		
48-18613A40	3	18 3/4	17	L	ALUM	SOL1612-188-17		SOL1642-188-17		
48-18614A40	3	18 1/4	19	R	ALUM	SOL1611-183-19		SOL1641-183-19		
48-18615A40	3	18 1/4	19	L	ALUM	SOL1612-183-19		SOL1642-183-19		
48-18616A40	3	17 3/4	21	R	ALUM	SOL1611-178-21		SOL1641-178-21		
48-18617A40	3	17 3/4	21	L	ALUM	SOL1612-178-21		SOL1642-178-21		
48-18618A40	3	17 1/2	23	R	ALUM			SOL1641-175-23		
48-18619A40	3	17 1/2	23	L	ALUM			SOL1642-175-23		
48-18620A40	3	17 1/4	25	R	ALUM			SOL1641-175-23		
48-18621A40	3	17 1/4	25	L	ALUM			SOL1642-173-25		
48-18610A6	3	19 1/4	15	R	SS	SOL1611-193-15		SOL1641-193-15		
48-18611A6	3	19 1/4	15	L	SS	SOL1612-193-15		SOL1642-193-15		
48-18612A6	3	18 3/4	17	R	SS	SOL1611-188-17		SOL1641-188-17		
48-18613A6	3	18 3/4	17	L	SS	SOL1612-188-17		SOL1642-188-17		
48-18614A6	3	18 1/4	19	R	SS	SOL1611-183-19		SOL1641-183-19		
48-18615A6	3	18 1/4	19	L	SS	SOL1612-183-19		SOL1642-183-19		
48-18616A6	3	17 3/4	21	R	SS	SOL1611-178-21		SOL1641-178-21		
48-18617A6	3	17 3/4	21	L	SS	SOL1612-178-21		SOL1642-178-21		
48-18618A6	3	17 1/2	23	R	SS			SOL1641-175-23		
48-18619A6	3	17 1/2	23	L	SS			SOL1642-175-23		
48-18620A6	3	17 1/4	25	R	SS			SOL1641-173-25		
48-18621A6	3	17 1/4	25	L	SS			SOL1642-173-25		



## BRAVO III

**HELICES DE ACERO INOXIDABLE**  
Hélices delanteras de 4 palas y hélices traseras de 3 palas. 19 estrias y escape a través de la hélice.

**STAINLESS STEEL PROPELLERS**  
Front propellers with 4 blades & rear propellers with 3 blades. 19 Tooth Splines and Thru hub exhaust.

**ELICHE IN ACCIAIO INOX**  
Eliche anteriori da 4 pale e eliche posteriori da 3 pale. 19 denti e scarico all'elica.

**HÉLICES EN ACIER INOXYDABLE**  
Hélices avant à 4 pales et hélices arrière à 3 pales. 19 cannelures et l'échappement par l'hélice.

DELANTERA FRONT ANTERIORE DAVANT	IZQUIERDA LEFT SINISTRA GAUCHE	TRASERA REAR POSTERIORE ARRIÈRE	DERECHA RIGHT DESTRA DROIT	B	D	P
SOL1654-160-20				4	16"	20
		SOL1651-144-20		3	14 3/8"	20
SOL1654-160-21				4	16"	21
		SOL1651-144-21		3	14 3/8"	21
SOL1654-158-22				4	15 3/4"	22
		SOL1651-143-22		3	14 1/4"	22
SOL1654-158-23				4	15 3/4"	23
		SOL1651-143-23		3	14 1/4"	23
SOL1654-155-24				4	15 1/2"	24
		SOL1651-140-24		3	14"	24
SOL1654-155-25				4	15 1/2"	25
		SOL1651-140-25		3	14"	25
SOL1654-155-26				4	15 1/2"	26
		SOL1651-140-26		3	14"	26
SOL1654-155-27				4	15"	27
		SOL1651-140-27		3	13 3/4"	27
SOL1654-150-28				4	15"	28
		SOL1651-138-28		3	13 3/4"	28

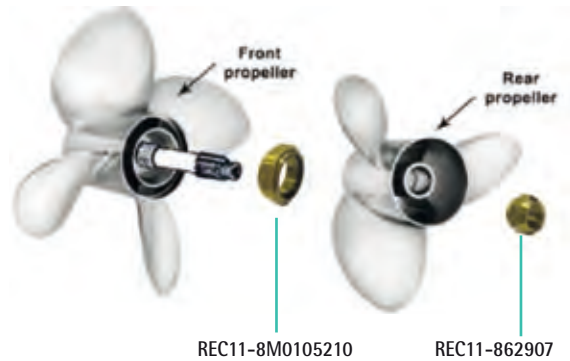

## HÉLICES 3 PALAS ALPHA ONE Y BRAVO ONE

Altas prestaciones. Núcleo de goma intercambiable con sistemas flo-torq & Vortex System. Disponible en acero inox y aluminio

## 3 BLADE PROPELLERS ALPHA ONE & BRAVO ONE

High performance / Rubber Hub interchangeable with flo-torq & Vortex System. Available in stainless Steel & Aluminium Propeller

## ELICHE DA 3 PALE ALPHA ONE / BRAVO ONE

Alte prestazioni. Mozzo in gomma intercambiabile con sistema flo-torq & Vortex System. Disponibile in acciaio inossidabile e alluminio.

## HÉLICES À 3 PALES ALPHA ONE, BRAVO ONE

Haute performance. Noyau en caoutchouc interchangeable avec le système flo-torq et Vortex. Disponible en acier inoxydable et en aluminium.

REF	OEM	
SOLRBX-102		ALPHA ONE BRAVO ONE



# RUBEX



-400 HP

-400 HP

AL	A	B	D	P	R
SOL9511-153-13		3	15,3	13	R
SOL9511-150-15		3	15	15	R
SOL9512-150-15		3	15	15	L
SOL9511-148-17		3	14,8	17	R
SOL9512-148-17		3	14,8	17	L
SOL9511-145-19		3	14,5	19	R
SOL9512-145-19	15	3	14,5	19	L
SOL9511-143-21		3	14,3	21	R
SOL9512-143-21		3	14,3	21	L
SOL9513-148-15		4	14,75	15	R
SOL9513-145-17		4	14,5	17	R
SOL9513-143-19		4	14,25	19	R
SOL9513-140-21		4	14	21	R

INOX   SS	A	B	D	P	R
SOL9571-158-15		3	15 3/4	15	R
SOL9572-158-15		3	15 3/4	15	L
SOL9571-155-17		3	15 1/2	17	R
SOL9572-155-17		3	15 1/2	17	L
SOL9571-153-19		3	15 1/4	19	R
SOL9572-153-19		3	15 1/4	19	L
SOL9571-150-21	15	3	15	21	R
SOL9572-150-21		3	15	21	L
SOL9571-148-23		3	14 3/4	23	R
SOL9572-148-23		3	14 3/4	23	L
SOL9571-145-25		3	14 1/2	25	R
SOL9572-145-25		3	14 1/2	25	L
SOL9531-145-15		3	14 1/2	15	R
SOL9532-145-15		3	14 1/2	15	L
SOL9531-143-17		3	14 1/4	17	R
SOL9532-143-17		3	14 1/4	17	L
SOL9531-140-19	15	3	14	19	R
SOL9532-140-19		3	14	19	L
SOL9531-140-21		3	14	21	R
SOL9532-140-21		3	14	21	L
SOL9531-140-23		3	14	23	R
SOL9532-140-23		3	14	23	L



TABLA DE APLICACIÓN DE HELICES SOLAS		PROPELLERS SOLAS APPLICATION GUIDE				GUIDA APPLICAZIONE ELICHE SOLAS				TABLEAU D'APPLICATION DE L'HELICE SOLAS				
		AMITA3	AMITA4	BRAVO TWO	SATURN	NEW SATURN	TITAN	HR TITAN3	HR TITAN4	SCORPION	LEXOR	SOLAS SKI	SOLAS PLASTIC	HIGH THRUST
FUERABORDA OUTBOARD FUORIBORDO HORSBORD	INFLATABLE	✓	✓		✓	✓	✓						✓	
	ALUMINIUM	✓	✓		✓	✓	✓							
	SKI BOAT	✓	✓				✓							
	BASSBOAT	✓						✓						
	FLATS BOAT	✓							✓	✓				
	BAY BOAT										✓			
	WALLEYE BOAT	✓									✓			
	OFFSHORE SINGLE	✓	✓				✓	✓	✓		✓			
	OFFSHORE DUAL	✓	✓				✓	✓	✓		✓			
	SPORT BOAT SINGLE										✓			
	SPORT BOAT DUAL										✓			
	HEAVY WORK BOAT	✓	✓			✓	✓		✓					
	COMMERCIAL	✓			✓									
	SAIL DRIVE													✓
	PLEASURE RUNABOUT	✓	✓		✓	✓	✓		✓					
	DECK BOAT	✓	✓						✓					
PONTOON	✓	✓		✓	✓	✓								
DENTRO-FUERABORDA STERNDRIVE ENTROFUORIBORDO HORSBORD	SKI BOAT													
	SPORT BOAT SINGLE								✓					
	SPORT BOAT DUAL								✓					
	FAMILY CRUISER	✓	✓				✓	✓	✓		✓			
	CRUISER BOAT			✓										
	DECK BOAT								✓					
	PONTOON								✓					
	HOUSEBOAT	✓	✓		✓	✓	✓		✓		✓			
INBOARD SKI BOAT											✓			
CARACTERÍSTICAS FEATURES CARATTERISTICHE CARACTERISTIQUES		AL	AL	AL INOX SS	INOX SS	INOX SS	INOX SS	INOX SS	INOX SS	INOX SS	INOX SS	INOX SS	PLAST.	AL
	<b>B</b>	3	4	3	3	3	3	3	4	3	3	3.4	3	4
	<b>R</b>	L	L	L	L	L	L	L	L	L	L	R	R	R
	NUCLEO DE GOMA RUBBER HUB MOZZO GOMMA NOYAU CAOUTCHOUC	✓	✓	✓	✓	✓	✓	✓	✓	✓	✓			✓

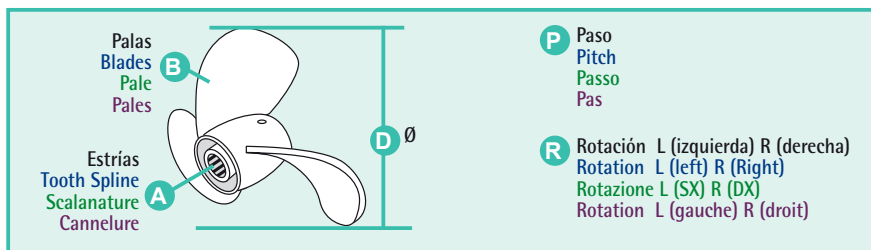

# REF --> OEM

REF	OEM	
<b>A</b>		
AM603905	88-832969T05	159
AM603910	88-832969T10	159
AM603915	88-832969T15	159
AM603920	88-832969T20	159
AM603930	88-832969T30	159
AMITA3		316
AMITA4		316

REF	OEM	
<b>B</b>		
BA1-47638	47638A1	218-250
BAMC-1-58759	58759A1	243
BAMC-1-58759	58759A10	243
BAMC-1-58759	58759A13	243
BAMC-1-58759	58759A14	225-243
BAMC-1-58759		248-250-252
BAMC-1-63122	63122A10	218-242
BAMC-1-63122	63122A13	212-242
BAMC-1-63122	63122A14	218-242
BAMC-1-63122		250-252
BAMC-1-95862	95862A5	221-242-250-253
BAMC-20-14478	14478T	249
BAMC-20-14478	14478T01	227-230-237-239-249
BAMC-20-55538	39920	245
BAMC-20-55538	55538A2	218-245
BAMC-20-55538		251
BAMC-20-864908A1	864908A1	229-233-249
BAMC1-47735	47735	244
BAMC1-47735	47735A1	244
BAMC1-47735	47735A17	240-244
BAMC1-47735		248-250-253
BAMC1-47736	47736	244
BAMC1-47736	47736A17	240-244
BAMC1-47736		248-250-253
BAMC1-47737	47737A1	240-244
BAMC1-47737	47737A10	244
BAMC1-47737		248-250
BAMC1-47738	47738A1	240-244
BAMC1-47738	47738A10	244
BAMC1-47738		248-250
BAMC20-61811A4	61811A3	248
BAMC20-61811A4	61811A4	248
BAMC20-61811A4		240
BAMC20-61851A3	61851A3	225-235-241-248
BAMC20-72963	48101A1	246
BAMC20-72963	72963A1	246
BAMC20-72963	72963A9	240-246
BAMC20-72963	76788A1	246
BAMC20-72963		251
BAMC20-76668	47877A4	245
BAMC20-76668	72964A1	245
BAMC20-76668	76668A1	245
BAMC20-76668	76668A3	240-245
BAMC20-76668		251
BAMC29-47587	47587	177
BAMC29-47587	47587A2	177
BAMC29-47587	861493A07	177
BAMC29-47587	861493A3	177
BAMC29-47587		180
BAMC29-59498	59498	180
BAMC29-59498	59498A1	180
BAMC29-60372	60372A1	180
BAMC29-60372	60372A2	180
BAMC29-60372	861493A07	180
BAMC29-62898	62898	180
BAMC29-62898	62898A1	180
BAMC29-63588	889333	178
BAMC29-63588	63588A1	178
BAMC29-63588		180
BAMC29-78985	78985A1	178-180
BAMC47-27-39923	39916	250
BAMC47-27-39923	27-39923	218-250

BRA125-1/2x1/2		123
BRA125-1/2x3/4		123
BRA125-1/2x3/8		123
BRA125-1/4x1/2		123
BRA125-1x3/4		123
BRA125-3/16x1/4		123
BRA125-3/4x3/4		123
BRA125-3/8x1/2		123
BRA125-3/8x3/8		123
BRA125-5/16x3/8		123
BRA125-5/8x3/4		123
BRA125-5/8x3/8		123
BS2138	88-8M2011907	158
BS2142	88-11178A01	158
BS2143	88-93582	158
BS5138		159
BS5139		159
BS5140	88-79023A94	159
BS5141		159
BS5142		159
BS5143		159
BS5175	88-8M0129533	159
BS5177	88-8M0129534	159
BS5181	88-8M0129535	159
BS5182	88-8M0129560	159
BS5183	88-8M0130941	159

REF	OEM	
<b>C</b>		
BS5185	88-8M0129528	159
BS5187	88-8M0129530	159
BS5189	88-8M0129531	159
BS5191		159
BS5291		159
BS5292	862646	159
BS5293		159
BS5294	862647	159
BS5295		159
BS5296	88-212619	159
BS5297		159
BS5298		159
BS5299		159

CARP74021		127
CEF500106GT	47-801332602	188
CEF500109	47-59362Q01	188
CEF500114T	47-879194186	188
CEF500120T	47-879312025	188
CEF500155	47-896332063	188
CEF500159G	47-862232A2	188
CEF500159G	47-8M0104229	188
CEF500161	47-809866T	188
CEF500161	47-831311350	188
CEF500167	3349198	188
CEF500167	3916720	188
CEF500167	47-853126	188
CEF500167	8M0056956	188
CEF500177GT	47-816814T	188
CEF500183G	3972366	188
CEF500301	47-43026Q02	188
CEF500313G	47-8998474	188
CEF500507K	32-44348	253
CEF500507K	32-44348001	253
CEF500507K	32-44348T	253
CEF500508K	32-14358	253
CEF500508K	32-14358001	253
CEF500508K	32-14358T	253
CEF500509K	86840A05	299
CEF500509K	86840A3	299
CEF500509K	8M0062406	299
CEF500511K	32-90949T	253
CEF500512K	32734	300
CEF500512K	18654A1	300
CEF500512K	32734A3	300
CEF500513K	74639Q02	299
CEF500515K	816431A1	299
CEF500516K	60932A1	299
CEF500516K	60932A4	299
CEF500520K	78458	300
CEF500520K	78458A1	300
CEF500522K	36223	299
CEF500522K	36223A1	299
CEF500522K	36223A2	299
CEF500523	70981A3	253
CEF500524	53114	253
CEF500524	53114A1	253
CEF500524		219
CEF500524		253
CEF500532K	32-807458T	163
CHAPROSU		163
CHARJ12YC		163
CHARNSC		163
CHARS12PYP		163
CHARS12YC		163
CHARV15YC4		163
CHARV9IMC		163
CHAV63C		163
CM31640	31640A4	288
CM31640	31640Q4	263-267
CM31640A	31640A4	288
CM31640A	31640Q4	263-267
CM34127	34127T2	288
CM34127A	34127T2	288
CM34762	34762A1	288
CM34762A	34762A1	288
CM43994	43994A2	288
CM43994	821631A1	288
CM43994		108-109
CM46399	46399A1	288
CM46399	822777Q1	288
CM46399		109
CM46399A	46399A1	288
CM46399A	822777Q1	288
CM55989	55989A9	288
CM55989	55989Q9	288-291
CM55989A	55989A9	288
CM55989A	55989Q9	288
CM55989A		291
CM762144	76214-4	288
CM762144	76214A2	281
CM762144	76214Q5	283
CM762144		109
CM762144A	76214-4	288
CM762144A	76214A2	281
CM762144A	76214Q5	283
CM762145	76214A2	288
CM762145	76214Q5	275-270-288
CM762145A	76214A2	288
CM762145A	76214Q5	275-288
CM762145A	76514Q5	279

REF	OEM	
<b>F</b>		
CM76214Q5	76214Q5	109-288
CM806105	806105Q1	267-275
CM806105	806188A1	288
CM806105A	806105Q1	267-275
CM806105A	806188A1	288
CM806188	806188A1	109-279-281-283-288
CM806188A	806188A1	108-279-281-283-288
CM806189	806189Q1	288-307
CM806189A	806189Q1	288-307
CM806190	806190A1	308
CM806190	806190Q1	288
CM806190		109
CM806190A	806190A1	308
CM806190A	806190Q1	288
CM821629	821629Q1	109-269-271-288
CM821629A	821629Q1	269-271-288
CM821630	821630A1/Q1	288
CM821630	821630Q1	277
CM821630		109
CM821630A	821630A1/Q1	288
CM821630A	821630Q1	277
CM821631	43994A2	288
CM821631	821631A1	288
CM821631	821631Q	296
CM821631	821631Q1	291
CM821631A	43994A2	288
CM821631A	821631A1	288
CM821631A	821631Q	296
CM821631A	821631Q1	291
CM865182CA		289
CM865182CZ		109-289
CMALPHAGEN1KITA	888756Q02	256-263-267-289
CMALPHAGEN1KITM	888756Q02	263-267-289
CMALPHAKITA	888756Q01	289
CMALPHAKITA	888756Q03	289
CMALPHAKITA		257-269-271-275
CMALPHAKITM	888756Q01	289
CMALPHAKITM	888756Q03	289
CMALPHAKITM		262-271-275
CMBRAVO1KITA	888758Q01	279-289
CMBRAVO1KITM	888758Q01	279-289
CMBRAVO2Y3KITA	888761Q01	281-289
CMBRAVO2Y3KITM	888761Q01	281-289
CMBRAVO3KITA	888761Q02	283-289
CMBRAVO3KITM	888761Q02	283-289
CMC		289
CMCC		289
CMPNAA		289
CMPNAAZ		289
CMPNBA		289
CMPNBZ		289
CMPNCA		289
CMPNCF16A		289
CMPNCF16Z		289
CMPNDA		289
CMPNDAF14UNS		283-289
CMPNDAF14UNSA		283-289
CMPNDZ		289
CMPNZF14A		289
CMX-1	85538	288
CMX-1	823341	288
CMX-1A	85538	288
CMX-1A	823341	288

FEDV-1984	44182A1	217
FEDV-3929	75416	217
FEL17019		206
FEL17049		212-214
FEL17060		207-211
FEL17069		205
FEL17119		206
FEL17124		210
FEL17145		213-214
FEL17160		208
FEL17165		211
FEL17205		213
FEL17219		206
FEL17260		207-211
FEL17319	27-46401	225-252
FEL17360		208-211
FEL17420	27-33395	210-233-235-237-253
FEL17460	27-73866	253
FEL17725		209-210-216
FEL17740	26-75980	216-217
FEL17925		206
FEL17926		206
FEL17945		2



REF	OEM	
<b>G</b>		
GEGC15		136
GS30430		122
GS30431		122
GS30432		122
GS30433		122
GS31001		112
GS31002		112
GS31055		112
GS31056		112
GS31065		112
GS31066	22-89771Q2	112
GS31067		112
GS31157		112
GS38105	814263A1	303
GS38122	35852	303
GS38310	54-815504456	229-233
GS38320	815504272	231
GS38320	54-815504256	221-222-227-237-239
GS38320	54-815504272	233
GS38320	54-815504372	221
GS38320	54-815504456	229
GS38320		223
GS38322	54-815504372	221-227-230-237-239
GS90002		109
GS90012		109
GS90019		109
GS90090		109
GS90092		109

REF	OEM	
<b>H</b>		
HGE4870	73813A1	218-219-221-225-235-240-241-250
HGE4929	864929A3	229-233
HGE6351	76351A04	241
HOT20560-MK		241
HOT20905-MK		224
HOT20937	816219A5	242
HOT20937	98562A6	224-242-246-251
HOT20937-MK		224-242
HOT20950	77234A2	244
HOT20950	77234A7	235-244
HOT20950		250-253
HOT20952	99746A17	227-230-243
HOT20952	99746A3	243
HOT20952	99746A8	243
HOT20952-MK		226-227
HOT20956	806235A04	242
HOT20956	806867A8	242
HOT20956	860235A04	221
HOT20956	99798A18	242
HOT20956		248-250-253
HOT20956-MK		220
HOT20957-MK		239
HOT20958	65604A12	241-244
HOT20958	65604A4	244
HOT20958		250-253
HOT20962	65603A12	241-244
HOT20962	65603A3	244
HOT20962		250-253
HOT20970	98504A3	227-237-239-246
HOT20971	60426A1	246
HOT20971	76351A04	219-225-235-241-246
HOT20971	76351A2	246
HOT20971		251
HOT20975-MK		220-222-224
HOT20976-MK		226-227-236-237-238-239
HOT20978	76771A2	219-235-241
HOT20985	93322A12	249
HOT20985	93322A12AV	227-237-239
HOT20985		227-239
HOT26371-MK		219-225-235-241
HOT27214-MK		235-236-237
HOT28503-MK		226-227-236-237-238-239
HR TITAN		316

REF	OEM	
<b>J</b>		
JAB11979-0001	47-896332063	107-188
JAB17018-0001	47-816814T	107-188
JAB17937-0001-P	47-879194186	107-188
JOH09-1028B	47-801332602	188

REF	OEM	
<b>L</b>		
LENS3213	35-809097	111
LENS3227	35-886638	111
LENS3240		111
LEXOR		316
<b>M</b>		
MAG15-602	84-813720A8	167
MAG15-602	84-816761Q8	167
MAG15-803	84-816761A15	167
MAG15-803	84-816761A2	167

REF	OEM	
MAG15-803	84-816781A15	167
MAG15-809		167
MAR076	12076A2	221-222-245-251
MAR078	807078A6	244
MAR078	807078T09	244
MAR078	807078T10	239-244
MAR078	89011A8	244
MAR078		249-253
MAR246	860246A10	244
MAR246	860246A15	237-244
MAR246	860246A3	244
MAR246	860246A9	244
MAR246	87114A19	244
MAR246		249-253
MAR309	864309T01	245
MAR309	864309T02	229-233-245-251
MAR988	44354A3	245
MAR988	807914A1	245
MAR988	807988A03	227-230-237-239-245
MAR988	807988A2	245
MAR3320PAR	807476A6	248
MAR3320PAR	93320A13	227-237-239-248
MAR3320PAR	93320A5	248
MAR3320PAR		227-237-239
MAR591	864591T02	229-233-245-251
MAR612	864612T01	229-243-248-249-252
MAR735	864308T01	243
MAR735	865049T01	243
MAR735	865735A02	233-243
MAR746	99746A17	227-230-243
MAR746	99746A3	243
MAR746	99746A8	243
MAR746		249-252
MAR929	864929A3	229-248
MAR988	44354A3	245
MAR988	807914A1	245
MAR988	807988A03	227-230-237-239-245
MAR988	807988A2	245-251
MP0180-001	10-812509184	152
MP425024	824324	254
MP425024	824324T	254
MP425036	824330	254
MP425036	824330T	254
MP425113	59974	254
MP425113	811575	254
MP425113	811575T	254
MP425149	72608	254
MP425149	72608T	254
MP426422		133
MP426574		133
MP426766		134
MP514516	807729T	193
MP514516	8M0153706	193
MP514693	33863	193
MP514693	33863T	193
MP514720		193

REF	OEM	
<b>N</b>		
NEW SATURN		316
NGKBRP5EFS-13		105-164-166
NGKBRP6EFS		104-105-106-164-165-166
NGKBRP6ES		107-166
NGKBRP6ES		164
NGKBRP6ES		164
NGKBR6FS		104-105-106-164-165-166
NGKBR6FS		106
NGKBR6FS		164
NGKBR9ES		105-10-164-165-166
NGKTR4A15		107
NGKIZFR7M		166
NGKPZTR5A-15		107
NGKTR5IX		165
NGKTR5IX		104-105-106
NGKTR6IX		104-105-106

REF	OEM	
<b>P</b>		
PAF15-07010004	479452	229
PAGB/T93-10	41471	223-231
PAGB/T97-1-8	12-36001	192-261-265
PAGB/T848-6	12-29245	261-265
PRE30107		301
PRE30212		301
PRE3300C05	8M0082577	301
PRE3300C06	8M0082578	301
PRE3300C07	8M0082579	301
PRE3300C08	8M0082580	301
PRE3300C09	8M0082581	301
PRE3300C10	8M0082582	301
PRE3300C11	8M0082583	301
PRE3300C12	8M0082584	301
PRE3300C13	8M0082585	301
PRE3300C14	8M0082586	301
PRE3300C15	8M0082587	301

REF	OEM	
PRE3300C16	8M0082588	301
PRE3300C17	8M0082589	301
PRE3300C18	8M0082590	301
PRE3300C19	8M0082591	301
PRE3300C20	8M0082592	301
PRE3300C21	8M0082593	301
PRE3300C22	8M0082594	301
PRE3300C23	8M0082595	301
PRE3300C24	8M0082596	301
PRE3300C25	8M0082597	301
PRE3300C26	8M0082598	301
PRE3300C27	8M0082599	301
PRE3300C28	8M0082600	301
PRE3300C29	8M0082601	301
PRE3300C30	8M0082602	301
PRE3300C31	8M0082603	301
PRE3300C32		301
PRE3300C33		301
PRE3300C34	8M0082604	301
PRE3300C35		301
PRE3300C36	8M0082605	301
PRE3300C38	8M0082606	301
PRE3300C40		301
PRE3300C42		301
PRE3300C44		301
PRE3300C46		301
PRE3300C48		301
PRE3300C50		301
PRE53006	8M0082529	301
PRE53007	8M0082530	301
PRE53008	8M0082531	301
PRE53009	8M0082532	301
PRE53010	8M0082533	301
PRE53011	8M0082534	301
PRE53012	8M0082535	301
PRE53013	8M0082536	301
PRE53014	8M0082537	301
PRE53015	8M0082538	301
PRE53016	8M0082539	301
PRE53017	8M0082540	301
PRE53018	8M0082541	301
PRE53019	8M0082542	301
PRE53020	8M0082543	301
PRE53021	8M0082544	301
PRE53022	8M0082545	301
PRE53023	8M0082546	301
PRE53024	8M0082547	301
PREKM63706	8M0082479	301
PREKM63707	8M0082480	301
PREKM63708	8M0082481	301
PREKM63709	8M0082482	301
PREKM63710	8M0082483	301
PREKM63711	8M0082484	301
PREKM63712	8M0082485	301
PREKM63713	8M0082486	301
PREKM63714	8M0082487	301
PREKM63715	8M0082488	301
PREKM63716	8M0082489	301
PREKM63717	8M0082490	301
PREKM63718	8M0082491	301
PREKM63719	8M0082492	301
PREKM63720	8M0082493	301
PREKM63721	8M0082494	301
PREKM63722	8M0082495	301
PREKM63723	8M0082496	301
PREKM63724	8M0082497	301

REF	OEM	
<b>R</b>		
RAC1/2F-1/2M		123
RAC1/2X16		123
RAC1/2X18		123
RAC1/2X20		123
RAC1000MA30		117
RAC1000VMA		117
RAC120AS		118
RAC120R-RAC-01		111
RAC2010PM-OR		117
RAC2010SM-OR		117
RAC2010TM-OR		117
RAC2020PM-OR		117
RAC2020SM-OR		117
RAC2020TM-OR		117
RAC2040PM-OR		117
RAC2040SM-OR		117
RAC2040TM-OR		117
RAC230R2		118
RAC245R2		118
RAC3/8F-3/8M		123
RAC3/8X10		123
RAC3/8X12		123
RAC3/8X14		123
RAC31871	35-884380T	112
RAC31871	35-8M0020349	112
RAC31871	35-8M0060041	112
RAC31871		105
RAC320R-INOX-01		111
RAC320R-RAC-01		111
RAC320R-RAC-02		111
RAC460R2		118



REF	OEM	REF	OEM	REF	OEM
RAC490R2		REC11-34933		REC13524A1	13524A5 169
RAC500MA30		REC11-35921	11-35921	REC13524A1	13524T1 169-174
RAC75/1000MA30				REC13524A6	13524A4 169
RAC75/500MAX		REC11-52707Q1	11-52707Q1	REC13524A6	13524A6 169
RAC900MA30				REC13524A6	13524Q06 169-174
RAC900VMA		REC11-8267089	11-8267089	REC13524A6	19405A4 169
RACPF5510		REC11-859124	11-859124	REC13524A6	90576A4 169
RACR11T		REC11-859135	859135	REC1376-818622R02	1347-818622 133
RACR12		REC11-859135	11-859135	REC1376-818622R02	1347-8186221 133
RACR120P		REC11-859135	11-859135	REC1376-818622R02	1376-5659A1 133
RACR120SM		REC11-862902	11-862902	REC1376-818622R02	1376-5744A1 133
RACR120TM		REC11-862903	82671013	REC1376-818622R02	1376-6152A1 133
RACR12P		REC11-862903	11-134371	REC1376-818622R02	1376-818622R02 133
RACR12S		REC11-862907	11-862907	REC1376-818622R02	
RACR12T		REC11-863332	11-863332	REC1396-4148	1396-4148 142
RACR20P		REC11-8M0105210	11-8M0105210	REC1396-4656	1396-4656 138-141
RACR20S		REC1140639		REC1396-5238	1396-5222 139
RACR20T		REC11979-0001	47-896332063	REC1396-5238	1396-5238 139
RACR24P		REC12-18448	12-18448	REC1396-5238	
RACR24S		REC12-191833	12-19183-3	REC1397-2060	1397-2060 136-139-140-141
RACR24T				REC1397-2150	1397-2150 113
RACR25P		REC12-191833	12-191833	REC1397-3327	1397-3327 136
RACR25S				REC1397-3327	1397-8546 136
RACR25T		REC12-191833		REC1397-3327	1397-8959 136
RACR26P		REC12-20084	12-20084	REC1397-3327	139-140-141-142
RACR26S		REC12-27880	12-27880	REC1397-5831	1397-5831 139-141
RACR26T		REC12-31211Q03	12-31211A2	REC1397-6367A1	1397-6367A1 138
RACR60P		REC12-31211Q03	12-31211Q03	REC1397-8582	1397-8582 142
RACR60S		REC12-31266	12-31266	REC1397-8760	1397-8760 137
RACR60T		REC12-32666	12-32666	REC1397-8760	1397-7099 137
RACR90P		REC12-32834	12-32834	REC1397-8760	1397-8760 137
RACR90S		REC12-35777	12-35777	REC1397-8760	
RACR90T		REC12-39116	12-39116	REC1397-8760	
RACRK19492UL		REC12-44163	12-44163	REC1397-8760	1397-8545 112
RACRK20726		REC12-44164	12-44164	REC1397-8760	1397-8767 112
RACRK22628		REC12-45176	12-45176	REC1397-8760	1397-8767Q 112
RACS3213	35-809097	REC12-45176	12-45176	REC1398-3089	1398-3089 138
RACS3214	35-809099	REC12-45810	12-45810	REC13980	22-806608A1 219-221-222-249
RACS3220UL		REC12-46765	12-46765	REC14-18323	14-18323 267-275-279-281
RACS3227	35-886638	REC12-72498	12-72498	REC14-44166T1	17-44166T1 308
RACS3228UL		REC12-815472	12-815472	REC14-79447	14-79447 263
RACS3240		REC12-815952	12-815952	REC14034A3	14034A3 306
REC004		REC12-835467Q01	13171	REC14035A3	14035A3 306
REC016940	879194241	REC12-835467Q01	12-835467Q01	REC14505A2	14505A2 304
REC016940	35-815419	REC12-85058	12-85058	REC14587A7	14587A5 267-275
REC02644		REC12-90931	12-90931	REC1463-9382	38547 162
REC0307239	25-33504	REC120		REC1463-9382	32193A2 162
REC0987883		REC12110		REC1463-9382	392-806529A1 162
REC10-20518	10-20518	REC12120	46-96148A8	REC1463-9382	898253T24 162
REC10-28668	10-28668	REC12632A7	12632A7	REC15-32563A1	15-32563A1 259-269-271
REC10-28668	10-28668	REC12644A1	12644A1	REC15-35980A1	15-35980A1 259-269-271
REC10-30206	10-30206	REC12708	12708	REC15-36178A02	15-36178A02 269-271
REC10-30206	10-30206	REC12711	12711	REC15-36178A02	15-36178A02 259
REC10-31700	10-31700	REC12769-35150	35-19485	REC15-401	84-813720A5 167-176
REC10-32470	10-32470	REC12784	12784	REC15-402	84-813720A5 167
REC10-34354	10-34354	REC13-33734	13-33734	REC15-405	84-813720A13 167
REC10-35386	10-35386			REC15-405	84-816761Q13 173
REC10-37562	10-37562	REC13-35048	13-35048	REC15-405	
REC10-37612	10-37612			REC15-42637A1	15-42637A1 265-273
REC10-43749	10-43749	REC13-35048	21-20553	REC15-44491A1	15-44491A1 275
REC10-45590	10-45590	REC13-39107	13-39107	REC15-45691A1	15-45691A1 259-269
REC10-53728	10-53728	REC13-423511	13-42351-1	REC15-47397A1	15-47397A1 263-267-275
REC10-53728	10-53728	REC13-423511	13-423511	REC15-57007A1	15-57007A1 261
REC10-53728	8M2000229	REC13037	13037	REC15-601	84-813720A11 167
REC10-668631	668631	REC13037	8733261	REC15-601	84-816761Q16 173-174-176
REC10-668631	10-668631	REC13220	13220	REC15-604	84-813720A7 167
REC10-72094	10-72094	REC1347-816373A4	1347-816373A4	REC15-604	84-816761Q7 167
REC10-73657	10-73657	REC1347-816373A4	1347-7362A1	REC15-604	
REC10-76156	10-76156	REC1347-816373A4	1347-804624R02	REC15-606	84-863656A2 167-175
REC10-79953Q04	10-79953Q04	REC1347-816373A4	1347-816373A4	REC15-71013	15-71013 259-269-271
REC10-806290	10-806290	REC1347-816373A4	1347-8292A4	REC15-801	84-813720A10 167
REC10-806327	10-806327	REC1347-816373A4	1347-9415T	REC15-801	84-813720A8 167
REC10-816601	10-816601	REC1347-816373A4	1347-9662A4	REC15-801	84-813720A9 167
REC10-816928	10-816928	REC1347-816373A4	3310-804624R1	REC15-804	84-813720A2 167
REC10-85486	10-85486	REC1347-818619R02		REC15-804	84-813720A3 167
REC10-861788	10-861788	REC1347-818619R02	1336-3594A1	REC15-804	84-813720A4 167
REC10-865982005	10-865982005	REC1347-818619R02	1347-818619/R02	REC15-804	84-816761A15 167
REC10-86801	10-86801	REC1347-818619R02	1347-8186191	REC15-804	84-816761A2 167
REC10-90926	10-90926	REC1347-818619R02	1351-4263A1	REC15-804	84-816761A4 167
REC10-96411	10-96411	REC1347-818619R02	1351-4263A2/A3	REC15-804	84-816761Q17 173-174
REC10-97934	10-97934	REC1347-818619R02	1351-5202A1	REC15-804	84-816781A15 167
REC10-97934A1	10-97934A1	REC1347-818619R02	1351-6065A2	REC15-804	84-816781A4 167
REC10-98794	98794	REC1347-818619R02	1351-7354A1	REC15-804	84-818781A4 167
REC10-98794	10-98794	REC1347-9661A3		REC15-808	
REC10615K	47-879312025	REC1347-9661A3	1347-7361A1	REC15-813	84-863656A1 167-175
REC11-13436	11-13436	REC1347-9661A3	1347-7364A1	REC15-815	84-816608A1 167-175-176
REC11-22339	11-22339	REC1347-9661A3	1347-8296A4	REC15-86749A1	15-86749A1 279-281-283
REC11-34933	11-34933	REC1347-9661A3	1347-9661A3	REC15-92914A1	15-92914A1 279-281
REC11-34933	11-34933	REC1348-818621R02	1347-8186211	REC15000K	3349198 188
REC11-34933	11-34933	REC1348-818621R02	1347-818621R02	REC15000K	3916720 188
REC11-34933	11-34933	REC1348-818621R02	1348-818621/R02	REC15000K	47-853126 188
REC11-34933	11-34933	REC1348-818621R02	1351-8480A2	REC15000K	8M0056956 188
REC11-34933	11-859116	REC1348-818621R02		REC15000K	
		REC13524A1	13524A1	REC1547-815930A7	1547-815930A7 257-269-271

REF	OEM	REF	OEM	REF	OEM
REC1547-861063A10	1547-861063A10	REC17020		REC21990	
REC1547-861063A12	1547-861063A12	REC17030			305
REC1547-861063A6	1547-861063A6	REC17040		REC22-328022	22-328022
REC1547-861063A8	1547-861063A8	REC17042			221-227-237-239-240-241-249
REC1547-9412A20	1547-9412A20	REC17046		REC22-32803	22-32803
REC1547-9412A21	1547-9412A21	REC17048			222-224-249
REC1547-9412A22	1547-9412A22	REC17100		REC22-36382	22-36382
REC1547-9412A23	1547-9412A23	REC17102			219-221-227-237-239-249
REC1589-865440H50	1589-865440H50	REC17110		REC22-384071	22-384071
REC1589-865440H50	5-5231100NP	REC17116			237
REC1589-865440H50	5-5231100TP	REC17120		REC22-41622	22-41622
REC1589-865440H50	5-5231300NP	REC17125			221-227-235-237-239-240-249
REC1589-865440H50	5-5441100TP	REC17140		REC22-428611	428611
REC1589-865440H50	5-5441400TP	REC17146			231-234
REC1589-865440H51	1589-865440H51	REC17177A1	13447A1	REC22-428611	22-428611
REC1589-865440H51	5-5231200NP	REC17177A1	17177A1		224-227-229-233-237-239-259-296
REC1589-865440H51	5-5231200TP	REC17177A1	68521A3	REC22-428611	22-428611
REC1589-865440H51	5-5441200TP	REC17177A1	68521A4	REC22-67892A05	22-67892
REC1589-865440H51	5-5441300TP	REC17177A1	74905A3	REC22-67892A05	22-8M0058389
REC1589-865440H52	1589-865440H52	REC17177A1	816148A1		283
REC1589-865440H52	5-5121300TP	REC17200	91823A3	REC22-67892A05	8M0058389
REC1589-865440H52	5-5441500TP	REC17207			263-267-275-277-279
REC1589-865440H52	5-5441700TP	REC17210		REC22-73379	73379
REC15995	15995	REC17211			108-109
REC15W40U3		REC17214		REC22-73379	22-73379
		REC17220			231-234
REC16-49545	16-49545	REC17224		REC22-73379	22-73379
		REC17230			229-233-237-239-291
REC16-56826	16-56826	REC17240		REC22-73379	22-73379
REC16-59579	16-59579	REC17241			249
REC16-70236	16-70236	REC17242		REC22-860382	22-860382
REC16-806300	16-806300	REC17243			295
REC16-97520	16-97520	REC17246		REC22-861150T02	22-861150A1
REC160ELEMENT		REC17248			185-295-297
REC1623-5356A4	1623-5356A4	REC27-815528		REC22-861150T02	22-861150A2
REC1623-815822A30	1623-815822A30	REC17310			185
REC1623-815822A30	1623-815822A6	REC17320		REC22-861150T02	22-861150T02
REC1623-815822A30	1623-815822A7	REC17340			185
REC1623-815822A47	1623-815822A47	REC17341		REC22-861150T02	22-861150T02
REC1623-815822A47	5-5111200TP	REC17341			295-297
REC1623-815822A47	5-5111300TP	REC17341		REC22-862225	22-862225
REC1623-815822A47	5-5111400TP	REC17342			179
REC1623-815822A47	5-5111500TP	REC17342		REC22-863786A1	22-863786A1
REC1623-815822A53	1623-815822A32	REC17342			234
REC1623-815822A53	1623-815822A43	REC17342		REC22-863786A1	863786A1
REC1623-815822A53	1623-815822A53	REC17342			229
REC1623-815822A53	1623-815822A53	REC17342		REC22-865417	22-865417
REC1623-815822A53	1623-815822A53	REC17342			295-297
REC1623-815822A53	5-5121200TP	REC17342		REC22-866725	866725
REC1623-815822A53	5-5121300TP	REC17342			231-234
REC1623-815822A53	5-5121400TP	REC17342		REC22-866725	22-866725
REC1623-815822A53	5-5121500TP	REC17342			221-224-229-233-235-237-239-241-241
REC1623-815822A55	1623-815822A45	REC17342			112-223
REC1623-815822A55	623-815822A55	REC17342		REC22-866725	22-866725
REC1623-8951A33	1623-8951A33	REC17342			290-291-296
REC1623-8951A33	5-5000147CP	REC17342		REC22-88847A1	22-88847A1
REC1623-8951A33	5-5000162CP	REC17342			179
REC1623-8951A33	5-5000181CP	REC17342		REC22-98477A2	22-98477A2
REC1623-8951A33	5-5000194CP	REC17342			261-265
REC1623-8951A37	1623-8951A37	REC17342		REC23-29804T	23-29804T
REC1623-8951A43	1623-8951A43	REC17342			261-265
REC1623-8951A43	5-5010147CP	REC17342		REC23-30617A2	23-30617A2
REC1623-8951A43	5-5010162CP	REC17342			261-265
REC1623-8951A43	5-5010181CP	REC17342		REC23-32632	23-32632
REC1623-8951A43	5-5010194CP	REC17342			259
REC1656-8866A55	1656-8866A55	REC17342		REC23-47508T	
REC1656-8866A55	5-5231100NP	REC17342			180
REC1656-8866A55	5-5231200NP	REC17342		REC23-67370	23-67370
REC1656-8866A55	5-5231300NP	REC17342			273
REC1656-8866A63	1656-8866A63	REC17342		REC23-805041A2	23-805041A2
REC1656-8866A63	5-5121300TP	REC17342			294-295-303
REC1656-8866A63	5-5231100TP	REC17342		REC23-806036A1	23-806036A1
REC1656-8866A63	5-5231200TP	REC17342			294-295-303
REC1656-8866A63	5-5231200TP	REC17342		REC23-806922	23-806922
REC1656-8M0046682	1656-8M0046682	REC17342			178-180
REC1656-8M0046682	5-5441700TP	REC17342		REC23-807073	23-807073
REC1656-8M0046733	1656-8M0046733	REC17342			308
REC1656-8M0046733	5-5441100TP	REC17342		REC23-815921A21	23-815921A21
REC1656-8M0046733	5-5441200TP	REC17342			273
REC1656-8M0046735	1656-8M0046735	REC17342		REC23-8159501	23-8159501
REC1656-8M0046735	5-5441300TP	REC17342			307
REC1656-8M0046738	1656-8M0046738	REC17342		REC23-816583	23-816583
REC1656-8M0046738	5-5441400TP	REC17342			257-273
REC1656-8M0046738	5-5441500TP	REC17342		REC23-824108	23-824108
REC1656-8M0046738	5-5441600TP	REC17342			267-275
		REC17342		REC23-847637	23-847637
		REC17342			293-298
		REC17342		REC23-853853002	23-853853002
		REC17342			217
		REC17342		REC23-853855001	23-853855001
		REC17342			217
		REC17342		REC23-861209A1	23-861209A1
		REC17342			276-277-297-303
		REC17342		REC23-89574	23-89574
		REC17342			305
		REC17342		REC23-8M8000506	92916
		REC17342			281
		REC17342		REC23-8M8000506	23-92916
		REC17342			279-283
		REC17342		REC23-90915	23-90915
		REC17342			174
		REC17342		REC23-99291T	23-99291T
		REC17342			306
		REC17342		REC23-99299	23-99299
		REC17342			304
		REC17342		REC23-99322	23-99322
		REC17342			292-304
		REC17342		REC24-17997A1	24-17997A1
		REC17342			269-271-277
		REC17342		REC24-30893	24-30893
		REC17342			267-275
		REC17342		REC24942	
		REC17342			110
		REC17342		REC24950	
		REC17342			110
		REC17342		REC25-16524	25-16524
		REC17342			215
		REC17342		REC25-16524	25-20415
		REC17342			215
		REC17342		REC25-20081	25-20081
		REC17342			215
		REC17342		REC25-21836	25-21836
		REC17342			215-273
		REC17342		REC25-25439	25-25439
		REC17342			215-259-261-265-269-271
		REC17342		REC25-25439	25-25439
		REC17342			277
		REC17342		REC25-29845	25-29845
		REC17342			277
		REC17342		REC25-30224	25-30224
		REC17342			180
		REC17342		REC25-30224Q	25-30224Q
		REC17342			215
		REC17342		REC25-30271	25-30271
		REC17342			261-265
		REC17342		REC25-30529	25-30529
		REC17342			215
		REC17342		REC25-30613	25-30613
		REC17342			215-261-265
		REC17342		REC25-31534	25-31534
		REC17342			263-267-275-276-281
		REC17342			270-281
		REC17342		REC25-32546	25-32546
		REC17342			215-259-269-271
		REC17342		REC25-33145	25-33145
		REC17342			215-261
		REC17342		REC25-33465	25-33465
		REC17342			192-215-279-283
		REC17342		REC25-33465	25-54029
		REC17342			215
		REC17342		REC25-33465	25-822370
		REC17342			279-281
		REC17342		REC25-35027	25-35027
		REC17342			269-271-277
		REC17342		REC25-35029	25-35029
		REC17342			215
		REC17342		REC25-36318	25-36318
		REC17342			273
		REC17342		REC25-38099	25-38099
		REC17342			215-265
		REC17342		REC25-38101	25-38101
		REC17342			215
		REC17342		REC25-38933	25-38933
		REC17342			215



REF	OEM	REF	OEM	REF	OEM
REC25-457101	25-457101	REC26-892683	26-892683	REC27-856704	27-856704
REC25-48171	25-48171	REC26-897153	26-897153	REC27-856705	27-856705
REC25-55801	25-55801	REC26-8M0033407	26-8M0033407	REC27-856705	27-856705
REC25-62700	25-62700	REC26-8M0150312	26-8M0150312	REC27-858524	27-858524
REC25-62705	25-62705	REC26-8M0150312	26-8M0150312	REC27-863724Q	27-863724Q
REC25-62706	25-62706	REC26-8M2005029	26-8M2005029	REC27-863724Q	27-863724Q
REC25-62706	25-62706	REC26-90562	26-90562	REC27-863724Q	27-863724Q
REC25-62706	25-62706	REC26-90925	26-90925	REC27-8637251	27-8637251
REC25-67202	25-67202	REC26-94038	26-94038	REC27-8637251	27-8637251
REC25-70937	25-70937	REC26-965031	26-965031	REC27-8637251	27-8637251
REC25-80863	25-20863	REC26-9656613	26-9656613	REC27-863726	27-863726
REC25-811461	811461	REC26900	26900	REC27-863726	27-863726
REC25-823683	25-823683	REC26901	26901	REC27-863726	27-863726
REC25-87400A2	25-87400A2	REC26904	26904	REC27-863726	27-863726
REC25-89497	25-89497	REC26905	26905	REC27-863726	27-863726
REC25-8M0084884	25-26802	REC27-13709	27-13709	REC27-863726	27-863726
REC25-8M0084884	25-8071341	REC27-142471	27-142471	REC27-863726	27-863726
REC25-8M0084884	25-8M0039163	REC27-14250	27-14250	REC27-863726	27-863726
REC25-8M0084884	8M0084884	REC27-18272	27-18272	REC27-864547A02	27-864547A02
REC25-90011	25-90011	REC27-33179Q02	27-33179Q02	REC27-864850A02	27-864850A02
REC25-94288	25-94288	REC27-33395	27-33395	REC27-89656-1	27-89656-1
REC25-97387	25-97387	REC27-33395	27-33395	REC27-89656-1	27-89656-1
REC25000	110	REC27-33395	8M2000819	REC27-8M0094247	24-8M0094247
REC25010	110	REC27-33918	27-8M2021920	REC27-8M0094247	27-801333454
REC25020	110	REC27-33956	27-33956	REC27-8M0094247	27-854129
REC25030	110	REC27-34213	27-34213	REC27-8M0094247	27-898101475
REC25W40U3	104-105-106-107-115	REC27-344861	27-34486-3	REC27-8M0094247	27-898101475
REC26-12224	26-12224	REC27-34897	27-34897	REC27-94914	27-94914
REC26-12709	26-12709	REC27-34898	27-34898	REC27-94996Q2	27-94996Q2
REC26-12709	26-12709	REC27-35898T	27-35898T	REC27-94996Q2	27-94996Q2
REC26-14240	26-14240	REC27-39915	27-39915	REC27-96429	27-96429
REC26-14756	26-14756	REC27-39917	27-39917	REC27-96429	27-96429
REC26-16709A2	26-16709A2	REC27-41609	27-41609	REC27-988231	27-988231
REC26-16977	26-16977	REC27-418122	27-418122	REC27-995061	27-995061
REC26-24590	26-24590	REC27-41812Q	27-41812Q	REC27-99757	27-99757
REC26-24590	26-24590	REC27-42457	27-42457	REC27-99757	27-99757
REC26-24590	26-24590	REC27-426311	27-42631-1	REC27-99777Q02	27-99777Q02
REC26-30913	26-30913	REC27-430331	27-430331	REC27-99777Q02	27-99777Q02
REC26-32511	26-32511	REC27-46820	27-46820	REC27-99777Q02	27-99777Q02
REC26-32511A1	26-32511A1	REC27-47510Q	27-47510Q	REC27-99960	27-99960
REC26-32911	26-32911	REC27-475901	27-47590-1	REC270	27-864547A02
REC26-33144A2	26-33144A2	REC27-47644-1	27-47644-1	REC270	27-864547A02
REC26-33467	26-33467	REC27-48042	27-48042	REC270	27-864549A02
REC26-34217	26-34217	REC27-480431	27-480431	REC270	27-864550A02
REC26-36556	26-36556	REC27-480431	27-480431	REC270	27-864550A02
REC26-36557	26-36557	REC27-48399	27-48399	REC28-30281	28-30281
REC26-38970	26-38970	REC27-48818Q01	27-48818Q01	REC28-8M0032833	28-8M0032833
REC26-419533	26-41953	REC27-49110	27-49110	REC294005	294005
REC26-43035	26-43035	REC27-49953	27-49953	REC296TWIN	296TWIN
REC26-43036	26-43036	REC27-524572	27-524572	REC30-72961	30-72961
REC26-43993	26-43993	REC27-52546	27-52546	REC30-879194A01	30-879194A01
REC26-455771	26-45577 1	REC27-53045Q01	27-53045Q01	REC30-879194A01	30-879194A01/A02
REC26-45587	26-45587	REC27-53045Q01	27-53045Q01	REC30-879194A01	30-879194A01/A02
REC26-54925	26-54925	REC27-53354	27-53354	REC30-88957T	30-88957T
REC26-55682	25-55682	REC27-54014Q1	27-54014Q1	REC30-88957T	30-88957T
REC26-55682	26-55682	REC27-54506	27-54506	REC30-98475T1	30-98475T1
REC26-56397	26-56397	REC27-54529	27-54529	REC300-00879	392-7803A4
REC26-56788	26-56788	REC27-558101	27-55810 1	REC300-00879	392-805570A2
REC26-62818	26-62818	REC27-56108	27-56108	REC300-8M0044991	300-8M0044991
REC26-66302	26-66302	REC27-56880	27-56880	REC300-8M0044991	8M0029482
REC26-67388	26-67388	REC27-60208Q	27-60208	REC301967	25-36318
REC26-69188	26-69188	REC27-60715	27-60715	REC302035	25-48452
REC26-69189	26-69189	REC27-64692	27-64692	REC302537	25-33466
REC26-70081	26-70081	REC27-64818Q4	26-64818Q4	REC302588	25-26722
REC26-72785	26-72785	REC27-64818Q4	27-64718A1	REC303347	25-26802
REC26-75624	26-75413	REC27-64818Q4	27-64818Q4	REC304174	25-32509
REC26-75624	26-75624	REC27-65577	27-65577	REC304454	13-69432
REC26-75988	26-75988	REC27-68714A6	27-68714	REC305123	25-33756
REC26-76868	26-14077	REC27-68715	27-68715	REC308627	25-20826
REC26-76868	26-76868	REC27-70142	27-70142	REC309731	25-29439
REC26-76868	26-76868	REC27-70905	27-70905	REC31-15842	31-15842
REC26-76868A04	26-76868A04	REC27-72479A5	27-72479A5	REC31-15844	31-15844
REC26-79831	26-79831	REC27-72805	27-72805	REC31-30894A1	31-30894A1
REC26-805344	26-805344	REC27-73666	27-73666	RM31-30894A5	31-30894A5
REC26-807006	26-807006	REC27-74830	27-74830	REC31-30895T	24-30893
REC26-811554	26-811554	REC27-803192A2	24-803192A2	REC31-30895T	31-30895T
REC26-8164641	26-816464-1	REC27-8052151	27-8052151	REC31-32573A1	31-32573A1
REC26-8164641	26-8164641	REC27-805396	27-805396	REC31-32575T1	31-32575T1
REC26-816575A2	26-816575A2	REC27-805760	27-805760	REC31-32575T1	31-32575T1
REC26-816575A3	26-816575A3	REC27-807218	27-807218	REC31-33138A1	31-33138A1
REC26-821092	26-821092	REC27-807473A1	27-807473A1	REC31-35928T1	31-35928T1
REC26-8219471	26-8219471	REC27-8079821	8079821	REC31-35988A12	31-35988A12
REC26-823894	26-823894	REC27-8079821	27-70143	REC31-35990A1	31-35990A1
REC26-861694	26-805080	REC27-8079821	27-701431	REC31-36387A1	31-36387A1
REC26-861694	26-861694	REC27-8079821	27-807982	REC31-53079A1	31-53079A1
REC26-864319	26-864319	REC27-8079821	27-8079821	REC31-54042T	31-54042T
REC26-88397	26-88397	REC27-8079821	27-8079821	REC31-61100A1	31-61100A1
REC26-88397A1	26-88397A1	REC27-8146801	27-8146801	REC31-66668A1	31-66668A1
REC26-88416	26-88416	REC27-815528	27-815528	REC31-66668A1	31-99328A1
REC26-89238	26-89238	REC27-8172771	27-8172771	REC31-66668A1	66668A1
REC26-89238	26-89238	REC27-850456	27-85046	REC31-66818A1	31-66818A1
REC26-892683	892683	REC27-856081	27-856081	REC31-814653T	31-814653
				REC31-815900	31-815900

REF	OEM	REF	OEM	REF	OEM
REC31-828437A2	31-828437A2	267-275	REC32-99904	32-99904	309
REC31-828439A2	31-828439A2	275	REC32-99904Q	32-99904Q	307-308
REC31-86748A1	31-86748A1	283	REC32-99904	32-99904Q	306
REC31-86748A1	31-86748A1	279-281	REC32077	25-896332077	184
REC31-86752A1	31-86752A1	279-281-283	REC32126	25-89633	183
REC31-86754T	31-86754T	279-281	REC32126	25-896332126	183
REC31-86763A2	31-86763A2	277	REC32175		227-228-229-230
REC31-86771	31-86771	277	REC321921	25-35480	215
REC31-87156	31-87156	277	REC324351	324351	261-265
REC31-92366A1	31-92366A1	263	REC326649	25-45711	215
REC310414	25-47254	215	REC326849	25-39695	215
REC310584	25-35276	215	REC3302-804689	3302-804689	136-140-141
REC310599	26-26226	216	REC3302-804844002	3302-804844002	139-140-141-171
REC313175	25-67202	215	REC3302-804845	3302-804845	138
REC313715	10-865321	283	REC3302-804845	3302-9437	138
REC31640Q4	31640Q4	284-285	REC3302-804845		139-140-141
REC31640Q4AL	31640Q4	108-284-285	REC3302-9031	1397-5837	136
REC32-14358001	14358001	231	REC3302-9031	3302-9031	136
REC32-14358001	32-14358001	253	REC3302-9031		139-140-141
REC32-14358001	32-14358001	227-220-230-233-237-239-253	REC3302-9407	3302-9407	136-140-141
REC32-14358001	32-14358T	253	REC3304-9354A2	1347-804623R1/02	132
REC32-16012	32-16012	199-201	REC3304-9354A2	3304-9354A2	132
REC32-160211	32-160211	200-201-202	REC3304-9354A2		139
REC32-32461	32-32461	198-291-295	REC3310-807312A1	1389-9670A2	133
REC32-32461	32-32461A1	198-108	REC3310-807312A1	3310-807312A1	133
REC32-33189	32-33189	199-201-202	REC3310-807312A1	3310-807312R02	133
REC32-33220	32-33220	200	REC3310-807312A1		139
REC32-33220	32-3322070	200	REC3310-860070A2	1389-9562A1	135
REC32-33220	32-8M0062614	200	REC3310-860070A2	3310-806077A2	135
REC32-33220		201	REC3310-860070A2	3310-806078A2	135
REC32-4172533	32-4172533	198-291-295	REC3310-860070A2	3310-815396A2	135
REC32-4172533	32-8M0062309	198	REC3310-860070A2	3310-860070A2	135
REC32-4172533		108-109	REC3310-860070A2	3310-9350A2	135
REC32-43437	32-43437	109-198-296	REC3310-860070A2	3310-9562A1	135
REC32-44348001	44348001	231	REC3310-860070A2		140
REC32-44348001	32-44348	253	REC3310-864941A01	3310-864941A01	134-140
REC32-44348001	32-44348001	221-222-227-229-230-233-237-239-253	REC3310-864942A01	3310-861448A1	135
REC32-44348001	32-44348T	223-253	REC3310-864942A01	3310-864942A01	135
REC32-48132	32-48132	201-202-203	REC3310-864942A01		140
REC32-52481	32-52481	198-200-201-202	REC3310-864943A01	3310-861245A1	134
REC32-52481	32-52481	202	REC3310-864943A01	3310-864943A01	134
REC32-54236	32-54236	259	REC331188	25-65936	215
REC32-55816	32-55816	309	REC331880	17-35973	267
REC32-55816	33-55816	305	REC333572	25-26543	215
REC32-58432A2	32-58432A2	305-309	REC333572	25-64068	215
REC32-59841	32-59841	305-309	REC33662	6325	170
REC32-59842	32-59842	305-309	REC33662	33662	170
REC32-8066351	32-8066351	200-201-202-203	REC33662	898253003	170
REC32-8066351	32-8066351	200-201-202-203	REC33662	898253005	170
REC32-8066351	32-8066351	199-201-202-203	REC33662	33662Q	170
REC32-806856	32-806856	199-201-202-203	REC33662	8M6001218	170
REC32-807407	32-807407	199	REC33662	F16900031	170
REC32-807458T	32-807458T	199	REC33662		171
REC32-807661	32-807661	199-201-202	REC33700	33700	170
REC32-807697	32-807697	200-201-202-203	REC33706	33706	170
REC32-808033	32-808033	199	REC33708	33708	168
REC32-8080441	32-808044-1	199	REC33765		238-239-241
REC32-8600891	32-8600891	199-203	REC33765T	33765	168
REC32-860205	32-860205	199-201-203	REC33765T	33765T	168
REC32-860220	32-860220	269-271	REC34127T2	34127	285
REC32-86036	32-86036	305	REC34127T2AL	34127	285
REC32-86036	32-86036	309	REC34235T	34235	170
REC32-86036	32-86036Q	309	REC34235T	34235T	170
REC32-861127	32-861127	306-307-308-309	REC34235A1	34235A1	171
REC32-861127	32-95858	309	REC3423A1	34235Q1	170
REC32-861128	32-861128	306-307-308-309	REC3423A1		171
REC32-862124	32-862124	200	REC34765A2	34765A2	254
REC32-862139	32-862139	200	REC35-06003	35-866340Q03	104-105-106-107-114
REC32-864588	32-864588	306-308-309	REC35-06004	35-883702Q	104-105-114
REC32-864588	32-99903	309	REC35-06007	60565	114
REC32-864589	32-864589	306-308-309	REC35-06007	35-802886Q	114
REC32-864589	32-99902	309	REC35-06007	35-8M0116378	114
REC32-864959	32-864959	306-307-309	REC35-19486	35-19486	116
REC32-864959	32-99903-1	309	REC35-19486	35-8M0103963	116
REC32-864960	32-864960	306-307-309	REC35-19487	35-19487	120
REC32-864960	32-99902-1	309	REC35-49088A2	35-49088A2	113
REC32-871171	32-87117	200	REC35-49088A2	35-49088Q2	113
REC32-871171	32-871171	200	REC35-49088A2		124
REC32-871171	32-871171	201-202-203	REC35-53336	3302-9033	113
REC32-87234	32-87234	309	REC35-53336	35-53336	113
REC32-87235	32-87235	309	REC35-53336Q	35-53336Q	113
REC32-88795	32-88795	199	REC35-53336Q		104-105-106-107-110
REC32-887952	32-887952	199-201-202	REC35-802893Q		104-105-110
REC32-89653	32-89653	198	REC35-802893Q01		104-105-110
REC32-897181	32-897181	199-202-203	REC35-805312	35-805312	120
REC32-897491	32-89749-1	200-202-203	REC35-805809	35-805809	121
REC32-897491	32-897301	201	REC35-805809T	35-805809T	121
REC32-8M0071007		200	REC35-807256	35-807256T	116
REC32-90949T	32-90949T	221-223-224-227-237-239-253	REC35-808275	35-808275	116
REC32-96246A4	32-96246A4	199-201-202	REC35-816168	35-816168	122
			REC35-865266		223
			REC35-866171A01	35-866171A01	112
			REC35-866171A01	866171A01	128
			REC35-866171A01		105-106-107
			REC35-879172104	35-879172104	107-116
REC35-879172143	35-879172143	107-120			
REC35-879312041	35-879312041	107-121			
REC35-892665	892665	128			
REC35-892665	35-892665	105-106-107-113			
REC35-898272048	35-898272048	107-120			
REC35-8M0046752	35-11004A1	112			
REC35-8M0046752	35-803897Q1	112			
REC35-8M0046752	35-8M0046752	112			
REC35-8M0046752		124-125			
REC35-8M0066483	35-8M0066483	107-121			
REC35-8M0067337	35-8M0067337	107-116			
REC35-8M0122423	35-884380T	112			
REC35-8M0122423	35-8M0020349	112			
REC35-8M0122423	35-8M0060041	112			
REC35-8M0138697	35-881132T	114			
REC35-8M0138697	35-8M0138697	114			
REC35-8M002131	35-8M002131	107-120			
REC35-8M6002390	35-8M6002390	116			
REC350038	12-92721	267			
REC350038	12-92721T	275			
REC3517857	35-803470	121			
REC3517857	35-80470Q	121			
REC3581078		119			
REC3581760	3581760	117			
REC35915	35915	263			
REC3593573	47-816814T	188			
REC35983	35983	259			
REC35983	35983	269			
REC35983	35983	271			
REC36223A2	36223	299			
REC36223A2	36223A1	299			
REC36223A2	36223A2	299			
REC378444	25661	157			
REC378444	25661T1	157			
REC3841697	47-801332602	188			
REC3843100	879172105	147			
REC3843751	803149	145-149-150			
REC3850396	805217A1	144			
REC3850396	864856A1	144			
REC3850396		149-150			
REC3850397	805218	148			
REC3850397	805218T	148			
REC3850397		149			
REC3850559	35-16595Q	114			
REC3850559	35-16595Q	121			
REC3850559	35-16595T1	121			
REC3850559	35-52731	121			
REC3850812	75832	277			
REC3850812	75832T1	259			
REC3850812	75832T1	269			
REC3852045	25-62704	215			
REC3852106	57-32850	198			
REC3852106	57-69143Q	198			
REC3852106		104-195-196			
REC3852455	27-73866	241			
REC3852455	27-73866	253			
REC3852455		208-211			
REC3852865	25-805331	215			
REC3852865	25-805331	283			
REC3852866	25-31986	215			
REC3852928	25-26855	215			
REC3853341	3				



REF	OEM		REF	OEM		REF	OEM	
REC3854190	50-56886	151	REC41641A8	41641A8	279-281	REC47820A1	47820	285
REC3854190	50-69865A1	151	REC41674T	41674T	296-297	REC47820A1AL	47820	285
REC3854260	3854260	173			227-229-231-233-237-239-291-296	REC48752T	48752T	261-265
REC3854261	811636	169	REC41802	41802		REC48952	48952	148
REC3854261	8116361	169	REC42419A1	42419A1	156	REC50-806965A4	50-806963A2	152
REC3854261	898253011	169	REC42419A1	862548A1	156	REC50-806965A4	50-806965A4	152
REC3854261	8M6001254	169	REC425062	807289A1	254	REC50-806965A4	50-863007A1	152
REC3854261	8M6001254	173	REC42600A09	42600A09	159	REC50-8M0090697	50-806965A2	152
REC3854311	804424	169	REC42600A09	42600A1	159	REC50-8M0090697	50-806965A4	152
REC3854311	850485	169	REC42600A09	42600A3	159	REC50-8M0090697	50-812429A2	152
REC3854311	850485	173	REC42600A09	42600A5	159	REC50-8M0090697	50-8M0090697	152
REC3854311	8504851	169	REC42724A3	42724A3	259	REC50-808011A05	50-808011A05	151
REC3854311	898253012	169	REC42785	42785	155	REC50-808011A05	50-80811A4	151
REC3854311	8M0062084	169	REC43-18411A2	43-18411A2	259-269	REC50-808011A05	50-88671A1	151
REC3854331	850484	168	REC43-18411A2	43-18411A4	259-268-269	REC50-863007A1	50-863007A1	151
REC3854331	3854331	173	REC43-45814A5	43-45814A5	259-269	REC50-8M0095471	50-8M0095471	151
REC3854331	393-3230	168	REC43-55778A3	43-55778A3	259-269	REC50-97499A2	50-47454	152
REC3854331	393-4988T	168	REC43-75325A3	43-75325A3	259-269	REC50-97499A2	50-65785A1	152
REC3854331	393-4988T2	168	REC43-818807	43-818807	174	REC50-97499A2	50-72550A2	152
REC3854331	393-9459Q1	168	REC43-828073A1	43-828073A1	267-275	REC50-97499A2	50-79604A3	152
REC3854331	850484T	168	REC43-853640A2	43-853640A2	271	REC50-99418A2	50-864340A2	151
REC3854331	850484T2	168	REC43-853641A2	43-853641A2	271	REC50-99418A2	50-99418A2	151
REC3854548	804418	168	REC43-853642A2	43-853642A2	271	REC500442		173
REC3854548	808483	168	REC43-853643A2	43-853643A2	271	REC500MA	35-850481	119
REC3854548	808483T	168	REC43-878087A2	43-878087A2	274-275	REC500MA	35-850481A1	119
REC3854548	808483T3	168	REC43-878617A2	43-853592A2	275	REC500MACON		122
REC3854549	808484	169	REC43436	43436	292-303	REC52-853594T	52-853594T	263-267-275
REC3854549	898253010	169	REC43713	43713	291-296	REC53-23720	53-23720	192
REC3854549	8M6001253	169	REC43994A2	43994	285	REC53-29641	53-29641	265-273
REC3854549	8M6001253	173	REC44-8146061	44-8146061	267	REC53-805272	53-805272	308
REC3854549	805224A1	145-149-150	REC44-8146061	8146061	275	REC53-815949	53-815949	108-307
REC3858261	805025A2	127	REC44-824110	44-824110	263-267-275	REC53-88242	53-88242	279-281-283
REC3858261	805656A2	127	REC44-850308	44-850308	275	REC53114A1	53114	253
REC3858261	805656A5	127	REC45-41939F1	45-41939F1	261	REC53114A1	53114A1	219-225-253
REC3858261	805656A6	127	REC45-42634	45-42634	265			227-230-236-237-238-239-258
REC3858261	861155A5	127	REC45-55796	45-55796	259	REC53400		
REC3858261	861155A6	127	REC45-557961	45-557961	269	REC54-38863	54-38863	291-296-300
REC3858462	57-45856	198	REC45-816919	45-816919	273	REC54-815504320	54-815504320	108-291-296-300
REC3858462	57-49213A1	198	REC45-853648	45-853648	273	REC54-815504412	54-815504412	295
REC3858462	57-93658Q	198	REC45518A3	45518A3	295-302	REC54-86049	54-86049	295-297-300
REC3858462	852956A1	105-195-196	REC45518T1	45518T1	295-302	REC55005		314
REC3858941	GM10482803	130-149	REC45589A3	45589A3	295-302	REC55006		314
REC3859054	809463A1	151-152-157	REC46-44292Q03	46-44292Q03	189-265	REC55131A5	55131A5	178
REC3859078	392-889925	161	REC46-48748T1	2495186	189	REC55134		314
REC3860769	12449	153	REC46-48748T1	2763441	189	REC553126	25-31305	215
REC3860769	19685	153	REC46-48748T1	46-48748A1	189	REC55989Q9	55989Q9	109-285-291
REC3860769	98555	153	REC46-48748T1	46-48748T1	189	REC55989Q9AL	55989Q9	108-285
REC3860769	817119	153	REC46-64141A11	46-64141A11	189-260-261	REC55989Q9M	55989Q9	285
REC3860769	817119A1	153	REC46-72774A32	46-59112A2	187	REC57-13457Q	57-13457Q	105-195-196-198
REC3860769	817119A4	153	REC46-72774A32	46-63450A2	187	REC57-34359	57-34359	198
REC3861267	392-881732	161	REC46-72774A32	46-72774A11	187	REC57-34359	57-37619T,Q	198
REC3861985	392-863704T	161	REC46-72774A32	46-72774A32	187	REC57-34359		105-195-196
REC3861985	392-8M0054588	175	REC46-72774A32	46-73823A7	187	REC57-36356	57-36356	198
REC3861985	8M0054588	161	REC46-72774A32	46-807151A12	187	REC57-48122Q	57-48122Q	196-198
REC3861985	898141	146-175	REC46-807151A14	46-807151A14	192	REC57-49043A1	57-49043A1	198
REC387247	31-30956T	263-267-275	REC46-807151A14	807151A14	191	REC57-49043A1	57-64032Q1	198
REC387817	31-42647A1	267-275	REC46-807151A9	46-807151A9	186	REC57-49043A1		104-195
REC3885317	50-864340A2	151	REC46-862914T10	46-862914T10	187	REC57-52692	57-52692	198
REC39-74381A1	39-74381A1	217	REC46-8M0113733	884727	185	REC57-64416	57-49211	198
REC391-5090	391-5090	170	REC46-8M0113733	8M0113733	185	REC57-64416	57-64416	198
REC391-5090	391-898253004	170	REC46-8M0113733	8503991	185	REC57-65607Q	57-65607T	104-195-198
REC391-5090	8M6001250	170	REC46-8M0113734	8M0113734	185	REC57-78200Q1	57-78200Q1	196-198
REC391-5090Q1	391-5090A1	171-172	REC46-8M0113734		187-193	REC57-807755Q04	57-807755Q04	197
REC391-5090Q1	391-5090Q1	170	REC46-8M0113735	8504541	185-187-193	REC57-807755Q05	57-807755Q05	197
REC391-5090Q1	50-805991	152	REC46-8M0113736	883925	185	REC57-816295Q	57-816295Q	104-195-196-198
REC392-6316	392-6316	176	REC46-8M0113736	8M0113736	185	REC57-817113	57-817113	197
REC392-6324Q1	392-6324A1	171	REC46-96148A8	46-60367A1	190	REC57-861049Q	57-861049Q	197
REC392-6324Q1	392-6324Q1	171	REC46-96148A8	46-96148A5	190	REC57-861757Q	57-861757Q	197
REC392-6324Q1	392-6324T1	171	REC46-96148A8	46-96148A8	190	REC57-861758Q	57-861758Q	197
REC392-6324Q1	392-6324T1	171-172	REC46-96148T1	46-96148T1	261-265	REC57-861759Q	57-861759Q	197
REC392-6325Q1	392-6325A1	171	REC46020T02	46020T02	259-269	REC57-865615Q01	57-865615Q01	197
REC392-6325Q1	392-6325Q1	171	REC46335	46335	219-221-222-224-225-227-235-237-239-240-241	REC57-865615Q02	57-865615Q02	197
REC392-6325Q1	392-6325T1	171	REC46335	11-46335		REC57-865615Q03	57-865615Q03	104-105-197
REC392-6325Q1	392-6330	176	REC46399	46399		REC57-865615Q04	57-865615Q04	104-105-197
REC392-9086T	392-9086T	168	REC46399AL	46399		REC57-865615Q05	57-865615Q05	197
REC392-9086T	392-9086T	168	REC47-43026Q02	47-43026Q02	109-188-273	REC57-865615Q06	57-865615Q06	197
REC392-9766	392-9766	168	REC47-43026Q06	47-43026Q06	108-190	REC57-865615Q07	57-865615Q07	197
REC392-9766	392-9766Q1	168	REC47-59362A4	47-59362A4	187-191	REC57-865615Q08	57-865615Q08	104-105-197
REC392-9766	392-9766Q1	168	REC47-59362Q01	47-59362Q01	104-105-106-185-186-187-188-192	REC57-865615Q10	57-865615Q10	197
REC392-9766	392-9766T	168	REC47-59362Q08	47-59362Q08	191	REC57-879150023		195
REC392-9766	F16900185	168	REC47-59362T5	47-59362T5	191	REC57-879172120	57-879172120	107-198
REC393-4988	393-3230	168	REC47-59362T6	47-59362T6	191	REC57-879194425	57-879194425	198
REC393-4988	393-4988	168	REC47-809866T	47-809866T	188	REC57-879194425	57-898101624	198
REC393-4988	393-4988T	168	REC47-809866T	47-831311350	188	REC57-879194425		107
REC393-4988	393-4988T2	168	REC47-862232A2	47-862232A2	188	REC57-882531	57-882531	198
REC393831	393831	269-271-277	REC47-862232A2	47-8M0104229	188	REC57-882531T	57-882531T	198
REC393831	3938311	259	REC47-862232A2		104-105-106-107-187	REC57-898101579	57-898101579	107-198
REC40005334	88751A02	175	REC47-89984Q5	47-89984Q5	108-190-260-261-264-265	REC57-898101580		195
REC40005334	888751A03	175	REC47-89984T4	47-89984T4	108-188-261-265	REC57-8M0088876	57-8M0088876	197
REC40005334	888751A1	175	REC47441A1	47441A1	180	REC57-8M0093495	57-8M0093495	198
REC41400		147				REC57-8M0093495	8M0067268	198
						REC57-8M0093495		107
						REC57-8M0097728	57-8M0074767	197
						REC57-8M0097728	57-8M0097728	197
						REC57-8M0097728		197
						REC57-91035Q1	57-91035Q1	195-196-198

REF	OEM	REF	OEM	REF	OEM
REC57-96834Q		REC802632T	802632	REC814819A2	814819A2 259-269
REC58033	58033	REC802632T	802632T	REC814819A7	814819A7 271
REC58033	898253007	REC802632T		REC815303T	815303T 297
REC58217	58217	REC803148	803148	REC815407A2	13753A2 168
REC58217	898253008	REC803623001	803623001	REC815407A2	815407A2 168
REC58217	58217Q	REC803623001	811406	REC815407A2	815407Q02 168-174
REC58217	8M6001251	REC803623001	803623	REC815471T1	815471T1 109-300
REC59078Q3	59078Q3	REC804626R02	1347-6493A1	REC815919A1	815919A1 273
REC59501A1	59501A1	REC804626R02	1347-7363A1	REC815935A7	815935A7 307
REC59503	59503	REC804626R02	1347-7366A	REC815954A7	815954A7 307
REC59826A3	59826A3	REC804626R02	1347-804626R1	REC816431A1	816431A1 295
REC59830A7	59830A7	REC804626R02	1347-8288A1	REC816431A1	816431A1 299
REC59830A7	814819A3	REC804626R02	1347-8291A3	REC816431A1	
REC60207	60207	REC804626R02	804626R02	REC816597A1	816597A1 273
REC60252A2	60252A2	REC804626R02		REC816607	816607 295
REC60930	60930	REC805016A1	805016A1	REC816685	816685 295-302
REC60932A4	60932A1	REC805100	805100	REC8168112	8168112 259-269-271
REC60932A4	60932A4	REC805101T	805101T	REC817275Q05	817275Q05 109-191
REC60932A4		REC805185A3	805185A3	REC8172761	8172761 273
REC62092T	54552	REC805185A3	805185A37	REC817377	817377 173-176
REC62092T	62092	REC805185A36	805185A36	REC817377T	817377T 176
REC62092T	62092T	REC805222A1	805222A1	REC818349T1	818349T1 275
REC62092T		REC805223T	805223	REC818349T1	818349T1 263-267
REC621041	621041	REC805223T	805223T	REC818763A10	818763A10 275
REC64851	58034	REC805223T		REC818763A10	818763A10 263-267
REC64851	81-64851	REC805227A1	805227A1	REC821526001	821526001 273
REC64851		REC805298A1	805298A1	REC821629Q1	821629Q1 284-285
REC65057T1	65057A1	REC805298A1	85785-2	REC821629Q1AL	821629Q1 284-285
REC65057T1	65057T1	REC805298A1	85785T	REC821630Q1	821630Q1 284-285
REC65533A1	65533A1	REC805320A03	805320A03	REC821630Q1AL	821630Q1 284-285
REC65864	65864	REC805536A2	805536A2	REC821631Q1	821631Q1 284-285
REC65864	78016	REC805629A1	805629A1	REC821631Q1AL	821631Q1 108-109-284-285
REC65864		REC805759Q01	43557	REC823426A1	823426A1 139-140-141-142
REC65L-13915-00	808504	REC805759Q01	16457A4	REC823427A1	1397-2067 137
REC65L-13915-00	808504T1	REC805759Q01	43557A1	REC823427A1	1397-2634 137
REC65L-13915-00	808504T1	REC805759Q01	805759A1	REC823427A1	1397-3459 137
REC65L-13915-00		REC805759Q01	805759A2	REC823427A1	1397-7542 137
REC66081A2	66081A2	REC805759Q01	805759A5	REC823427A1	1397-7542 137
REC681001	681001	REC805759Q01	805759A5	REC823427A1	1397-7547 137
REC69354A2	69354A2	REC805759Q01	805759Q01	REC823427A1	1397-8872 137
REC69729	56045	REC805759Q01	805759T1	REC823427A1	1397-8873 137
REC69729	59755	REC805759Q01	805759T2	REC823427A1	823427A1 137
REC69729	69729	REC805884T	90746A1	REC823427A1	
REC69729	78403A2	REC805884T	805884	REC823727	823727 139-140-141
REC70125A02	70125	REC805884T	805884T	REC824326002	
REC70125A02	70125A02	REC806034A1	866200A01	REC8245191	8245191 265-273
REC70125A02	70125A1	REC806105Q1	806105Q1	REC827682T	827682 126
REC70720		REC806105Q1AL	806105Q1	REC827682T	827682T 126
REC70817B	26-8M0050563	REC806188Q01	806188	REC828692A1	828692A1 269-271
REC70817B	26-97664	REC806188Q01AL	806188	REC828830A2	828830A2 275
REC70817B	26-976641	REC806189Q1	806189Q1	REC829207	57-48120Q1 104-105-195-196-198
REC70981A3	70981A3	REC806189Q1AL	806189Q1	REC834975	392-6326 169
REC71464A01	71464	REC806190Q1	806190Q1	REC834975	392-6326T 169
REC71464A01	72625	REC806190Q1AL	806190Q1	REC834975	F16900044 169
REC71464A01	71464A01	REC806191T	806191T	REC834975	
REC71831	64850	REC806490T	36525	REC835702	392-6318 168
REC71831	87-71831	REC806490T	806490	REC835702	392-6318T 168
REC71831		REC806490T	811091	REC835702	F16900184 168
REC73873A1	73873A1	REC806490T	806490T	REC84-817376T01	84-817376T01 173
REC74639Q02	74639Q02	REC806490T	97-257	REC84-819514T26	
REC75832T	75832T	REC806490T	97257A1	REC849899	849899 130-150
REC7614T1	76214	REC806612T	806612T	REC85060	85060 306-307-308
REC7614T1AL	76214	REC806673T1	806673T	REC8507522	8507522 302
REC76214Q5	76214Q5	REC807166A1	807166A1	REC8507522	8507522 292
REC76214Q5AL	76214Q5	REC807166A3	14348A1	REC852565	89-68258A4 157
REC762144	76214-4	REC807166A3	807166A3	REC852565	89-85365A41 157
REC762144AL	76214-4	REC807252Q3	807252Q3	REC853635	853635 271
REC76325A2	76325A2	REC807252Q4	807252Q4	REC853678T	853678 144
REC76771A2	76771A2	REC807252Q4	807252T4	REC853678T	853678T 144
REC76771A2	76771A3	REC807252Q5	807252Q5	REC853998A1	853998 149-150
REC76771A2		REC807652T	807652	REC853998A1	853998 131
REC76850A2	76850A2	REC807652T	807652T	REC853998A1	853998A1 131
REC76865	76865	REC807653T	807653	REC853998A1	853998T 131
REC77123	77123	REC807653T	807653T	REC853998A1	853998 149
REC774811	774811	REC807757T	807757T	REC854445	854445 144-150
REC78403A2	78402	REC807929A1	807929A1	REC855314	855314 157
REC78403A2	78403A1	REC807952A1	807952A1	REC855686	855686 110
REC78403A2	78403A32	REC807964A1	807964A1	REC85784A1	85784A1 142
REC78403A2	817119A4	REC807964A1	807964A1	REC85785A2	85785A2 142
REC78403A2	92497A3	REC807964A1	907964A1	REC86-865202T	86-865202T 158
REC78458A1	78458	REC808500	808500	REC860235A03	808687A12 243
REC78458A1	78458A1	REC809064	809064	REC860235A03	808687A3 243
REC78458A1		REC809065	809065	REC860235A03	860235A03 222-243-252
REC78984A08	78984A08	REC809065	823728	REC860349A1	860349A1 129-150
REC78984A08	78984A1	REC809065	835076	REC861126A1	861126A1 129-149-150
REC801766	801766	REC809065		REC861155A3	861155A2 127
REC801767	801767	REC809066	809066	REC861155A3	861155A3 127
REC801768	801768	REC80W90U6		REC861155A6	805025A2 127
REC802630T01	802630	REC811534	811534	REC861155A6	805656A2 127
REC802630T01	802630001	REC811536T	811536	REC861155A6	805656A5 127
REC802630T01	802630T	REC811536T	811536T	REC861155A6	805656A6 127
REC802630T01	802630T01	REC811536T		REC861155A6	861155A5 127
REC802630T01	8M0069803	REC814604T1	814604A1	REC861155A6	861155A6 127
REC802630T01		REC814605	814605	REC861156A03	861156A03 129
				REC861156A04	861156A04 129



REF	OEM		REF	OEM		REF	OEM	
REC861156A1	861156A1	126	REC866169T01	866169Y01	128	REC898253013	884790	169
REC861249A1	861249	144	REC866170A01	866170A01	127-128	REC898253013	898253013	169
REC861249A1	861249A1	144	REC866779A1	86779A1	277	REC898253013	8M6001222	169-175
REC861249A1		149-150	REC86840A05	86840A05	297-299	REC898253013		169
REC861259	861259	142	REC86840A05	86840A3	299	REC89825302	898253029	169
REC861523A9	861523A9	303	REC86840A05	8M0062406	299	REC89825302	391-5088	169
REC861578	861578	292	REC86840A05		108-109	REC89825302	391-7057	169
REC861579	861579	186	REC87-18286A43	87-18286A43	160	REC89825302	391-7057T	169
REC861579	861579	192	REC87-19674A1	87-19674A1	160	REC89825302	8M6001224	169
REC861579	807731T	186	REC87-805605A1	87-805605A1	147	REC89825302	F16901224	169
REC861677T	818383T	124	REC87-808009A2	87-808009A2	292	REC89825302		171-172
REC861677T	861677T	124	REC87-808009A2	87-8M0052935	292	REC898253T22	884792	169
REC861677T		126	REC87-808009A2		292	REC898253T22	898253T22	169-175
REC862030T01	862030T	154	REC87-814281A5	87-814281A5	292	REC898253T23	888731	169
REC862030T01	862030T01	154	REC87-858679T2	87-858679T2	160	REC898253T23	898253T23	169-175
REC862031T1	862031T	153	REC87-859032T02	87-859032T02	160	REC8M0032834	28-8M0032834	261
REC862031T1	862031T	153	REC87-864252	87-864252	147	REC8M0032834	8M0032834	265
REC862031T1	862031T1	153	REC87-864252A01	87-864252A01	147	REC8M0042641	12-8M0042641	261
REC862048A1	97399	124	REC87-892150Q02	87-892150Q02	174	REC8M0042641	8M0042641	265
REC862048A1	812454A1	124	REC87-91941A8	87-91941A8	160	REC8M0047215	864650A05	128
REC862048A1	812454A3	124	REC87290A23	87290A26	177	REC8M0047215	864650A13	128
REC862048A1	862048A1	124	REC87290A4	87290A4	178-179-180	REC8M0047215	8M0047215	128
REC862048A1	97399A2	124	REC87399A2	87399A2	306	REC8M0047215		129
REC862048A1		125-126	REC87399A2	87399A2	308	REC8M0052939	814281A7	292
REC862077A1	41141A2	124	REC87399A2		306-308	REC8M0052939	889514A01	292
REC862077A1	862077A1	124	REC87399A3	87399A3	307	REC8M0052939	8M0052939	292
REC862077A1		125	REC87580		276-277-299	REC8M0052939		292-194
REC862132T	862132T	277	REC876037	8M0032176	158	REC8M0054726	881731	144
REC862209	862209	297	REC876037	8M0057697	158	REC8M0054726	8M0054726	144-150
REC862210A01	22-862210A01	227	REC879150054		107	REC8M0058164	97401	125
REC862210A01	22-862210A01	229	REC879150150	849934	144	REC8M0058164	8M0058164	125
REC862210A01	22-862210A01	230	REC879150150	879150150	144	REC8M0058164		125-126
REC862210A01	22-862210A01	237	REC879150150		150	REC8M0061068	47442A1	180
REC862210A01	22-862210A01	239	REC879172	879172	120	REC8M0061381	860256A4	178
REC862344A	47585	124	REC879172	896332162	120	REC8M0061381	861006A1	178
REC862344A	71327	124	REC879172		107	REC8M0061381	8M0061381	178
REC862344A	77594	124	REC879172259	879172259	152	REC8M0062102	32-8M0062102	198
REC862344A	86234	124	REC879172259	896332191	152	REC8M0062102	32-8M0062102	296
REC862344A	8623405	124	REC879194185	879194185	184	REC8M0062770	8M0062770	126
REC862344A	86234A3	124	REC879194371	882481	152	REC8M0062770	8M0062770	128
REC862344A	86234A4	124	REC879194371	879194371	152	REC8M0064021	834832	154
REC862344A		125-126	REC879194401	46-879194401	185	REC8M0064021	834832T2	154
REC862351T	862351T	187	REC879194401	8M0094406	185	REC8M0064021	857006A3	154
REC86246T	71646	124	REC879194401	8M6005225	185	REC8M0068784	34623	147
REC86246T	78485	124	REC879194401		187	REC8M0068784	90806	147
REC86246T	86246	124	REC879194401	879194401	302	REC8M0068784	815425	147
REC86246T	86246A1	124	REC88-79023T10	88-79023T10	158	REC8M0068784	87-815425T	147
REC86246T	86246T	124	REC88035	88035	306	REC8M0068784	8M0068784	147
REC86246T		125-126	REC881693002	881693002	130-150	REC8M0073435	842725A3	125
REC86247T	46860	124	REC881879T11	859210	147	REC8M0073435	861676A1	125
REC86247T	83196	124	REC881879T11	881879011	147	REC8M0073435	861676T09	125
REC86247T	78820	124	REC881879T11	859210T	147	REC8M0073435	8M0073435	125
REC86247T	86247	124	REC881879T11	859604A1	147	REC8M0073435		125
REC86247T	86247A2	124	REC881879T11	881879A6	147	REC8M0077616	805544T	145
REC86247T	86247T	124	REC881879T11	881879T11	147	REC8M0077616	8M0077616	145
REC86247T		125-126	REC882376	882376	116	REC8M0077616		150
REC862548A1	865380A13	156	REC88243A3	88243A3	279	REC8M0080805	8M0080805	291-296-306-307-308
REC862998	862998	145-149-150-223	REC88243A3	88243A3	281	REC8M0080805		290-296-306-307-308
REC863077T	863077T	154	REC88243A3	88243A3	283	REC8M0082988	828358	146
REC863077T	86307AR01	154	REC882571	882571	154	REC8M0082988	8283582	146
REC86310	16755Q1	277	REC882571	8M0084523	154	REC8M0082988	8M0030022	146
REC863802T2	863802T2	179	REC882687	882687	122	REC8M0082988	8M0082988	146
REC864244A2	864244A2	277	REC882687	35-8M0150917	122	REC8M0087834	885165	144
REC864281A2	864281A01	270	REC882751A04	821509	158	REC8M0087834	8M0087834	144
REC864281A2	864281A2	269-271	REC882751A04	821509T01	158	REC8M0089715	807252T1	182
REC864281A2	86481A2	271	REC882751A04	882751A04	158	REC8M0089715	8M0089715	182
REC864281A2	865491A01	271	REC883166A2	883166A2	156	REC8M0089715		104-105-106
REC864282T	864282T	271	REC885174	885174	130-149-150	REC8M0091470	807252T2	182
REC864297T01	864297	146	REC885176	885176	130-149-150	REC8M0091470	8M0091470	182
REC864297T01	864297001	146	REC889419	889419	117	REC8M0091470		104-105-106
REC864297T01	864297T01	146	REC889422	889422	117	REC8M0092849	8M0092849	160
REC864493	864493	104-105-106-181	REC89-818997A1	89-818997A1	157	REC8M0093480	8M0066646	181
REC864572	864572	112	REC89-818997A1	89-818997T1	157	REC8M0093480	8M0067292	181
REC864572	35-864572	112	REC89-818999A2	89-805188A1	157	REC8M0093480	8M0093480	181
REC864572		106	REC89-818999A2	89-818999A1	157	REC8M0093480		107
REC864625T	864625T	194	REC89-818999A2	89-818999A2	157	REC8M0093561	879194215	181
REC865193	865193	194	REC89-96054T	89-91975	157	REC8M0093561	879194231	181
REC865182Q01	865182	285	REC89-96054T	89-96054	157	REC8M0093561	879194233	181
REC865182Q01AL	865182	285	REC89-96158T	89-96054T	157	REC8M0093561	896332148	181
REC865329A02	865329A02	292-304	REC89-96158T	89-818864	157	REC8M0093561	8M0093561	181
REC865380A13	14336A20	155	REC89-96158T	89-818864T	157	REC8M0093561		107
REC865380A13	14336A8	155	REC89-96158T	89-96158T	157	REC8M0095310	8M0095310	146
REC865380A13	865380A13	155	REC891736T	17649	156	REC8M0095310	8M0095310	293
REC865380A13	865380A25	155	REC891736T	17649T	156	REC8M0095310	8M0095310	298
REC865380A13	88183A12	155	REC891736T	891736T	156	REC8M0095953	8M0095953	231
REC865380A25	14336A9	155	REC89260		254	REC8M0098619	889341	143
REC865380A25	414336A6	155	REC892615002	892615	146	REC8M0098619	8M0098619	143
REC865380A25	88183A12	155	REC892615002	892615001	146	REC8M0103289	8M0062771	127-128
REC865436A02	865436A02	292-300	REC892615002	892615002	146	REC8M0111642	898101425	193
REC865436A03		108-109-300	REC892617	892617	146	REC8M0111642	8M0111642	193
REC865437A02	865437A02	292-300	REC892681	892681	128	REC8M0113182	8183812	194
REC865496A02	865496A01	277	REC892681	892681	130	REC8M0125617	805226A1	144
REC865496A02	865496A02	271	REC892681		150	REC8M0125617	881070T	144
REC865503T	865503T	271	REC895207	895207	107-122-184	REC8M0125617	8M0125617	144
REC865876A01	865876A01	283	REC896332057	896332057	193	REC8M0125617		149-150-223
REC866169T01	866169A01	126	REC89690T	89690T	184	REC8M0133370	8M0057679	129
REC866169T01	866169T01	126	REC898101505	898101505	153	REC8M0133370	8M0133370	129

REF	OEM		REF	OEM		REF	OEM	
REC8M0133370		128	REC91-859046Q3		311	RM21325765	801331174	143
REC8M0142542	8M0142542	148	REC91-859046Q4		311	RM21325765	801763272	143
REC8M0142695	8M0095468	145-231	REC91-888863	91-888863	173	RM21325765	54-896332164	143
REC8M0142695	8M0142695	145	REC93320A15	93320A10	237-248	RM21325765	864148A01	143
REC8M0144930	8M0144930	160	REC93320A15	93320A15	248	RM21325765		143
REC8M0148530	8M0148530	186	REC93320A15		237	RM22-43828	22-43828T	296
REC8M0148668	885342001	148	REC934231	934231	263-267	RM22-49718	22-49718	305
REC8M0148668	885342002	148-231-234	REC934241	934241	263-267	RM22-861163	22-861163	185-295-297
REC8M0148668	8M0148668	148-223	REC93568	35-93568	113	RM23-815921A17	23-815921A17	272-273
REC8M0153706	807729T	193	REC94286T1	94286	285	RM23-816599	23-816599	291
REC8M0153706	8M0153706	193	REC94286T1AL	94286	285	RM23-847638	23-847638	298
REC8M0155633	897345016	186	REC94576	94576	192	RM23-87560091	23-87560091	277
REC8M0155633	8M0129714	186	REC94916	94916	192	RM23-87560094	23-87560094	277
REC8M0155633	8M0155633	186	REC94998A4	94998A4	259	RM23-87560097	23-87560097	277
REC8M2003959	8M2003959	145	REC966900	57-77274	195-198	RM23-98356	23-98356	291-296
REC8M2003959	8M2003959	231-234	REC966903	57-74271Q	195-196-198	RM23-983571	23-983571	291-296
REC8M2003959		223	REC966931	57-13458Q	196-198	RM23-99352	23-99352	293-298
REC8M2004414	8M2004414	231-234-251	REC96705A1	96705A1	219-242-248-	RM26-879194364		216
REC8M2011027	79448	281	REC97258A1	34625	250-252	RM27-864549A02	27-864549A02	252
REC8M2011027	8M2011027	263-267-275-	REC97258A1	97258	148	RM31-86763A04	31-86763A04	277
REC8M2015937	8M2015937	269-271	REC97258A1	97258A1	148	RM32-805375	32-805375	199-202
REC8M2015938	8M2015938	269-271	REC97258A1	F16900152	148	RM32-806209-1	32-806209-1	199
REC8M6000623	8818793	148	REC97258A1	F16900198	148	RM32-860144	32-860144	200-201
REC8M6000623	881879010	148	REC97432A2	97432A2	217-303	RM32-860331	32-860331	200
REC8M6000623	8M6000623	148	REC98-8M0121940	98-8M0121940	191	RM32-861057	32-861057	200
REC8M6000634	889659002	147	REC982209	391-5075	168	RM35-802893Q		110
REC8M6000634	897447002	147	REC982209	391-5075Q1	168	RM35-863829	35-863829	113
REC8M6000634	8M6000634	147	REC982209	F16900148	168	RM35-866340Q02	35-866340Q03	114
REC8M6001217	391-5092	170	REC98230A1	98230A1	293-298	RM35-866594Q01	35-866594K01	110
REC8M6001217	391-5093	170	REC98504A3	98504A3	227-234-239-	RM35-866594Q01	35-866594Q01	110
REC8M6001217	391-898253001	170	REC985218		251-267	RM35-883702Q	35-883702Q	114
REC8M6001217	8M6001217	170	REC985218		168	RM35-8M2001030	35-8M2001030	113
REC8M6001217	F16900040	170	REC98703A26	98703A26	308	RM41646A9	41646A9	297
REC8M6001217		171-172	REC98703A3	98703A3	306	RM42260A6	42260A6	291
REC8M6001219	392-6325	170	REC98704A26	98704A26	308	RM42815A6	42815A6	295
REC8M6001219	392-898253005	170	REC98704A3	98704A3	306	RM43-14063A1	43-14063A1	279-281
REC8M6001219	8M6001219	170	REC99155T2	99155T2	105-106-182-	RM43-66773A3	43-66773A3	259
REC8M6001219	F16900031	170	REC99356A2	99356A2	224	RM43-887903A1	43-887903A1	277
REC8M6001219		171-172	RECEFP-KT		184-253	RM43-887906A1	43-887906A1	277
REC8M6001249	392-6324	170	RECGREU1		127	RM43-887909A1	43-887909A1	277
REC8M6001249	392-898223002	170	RECGS00530		109	RM43-887909A1	43-887909A1	277
REC8M6001249	8M6001249	170	RECGS01030	35-8M0067597	119-120	RM43881A14	8M0062568	291
REC8M6001249	F169000083	170	RECHOL17-6		107-119-120	RM43881A17	43881A17	296
REC8M6001249	F16900023	170	RECHOL17-7		135	RM44-41630T	44-41630T	279-281
REC8M6001249	F16900032	170	RECK309		135	RM44-41630T	44-850308	279
REC8M6001249	F16900189	170	RECK591		228-229-233	RM44-865322T	44-865322T	283
REC8M6001249		171-172	RECK6325		228-229-233	RM44181A1	44181A1	217
REC8M6001252	898253009	169	RECK8503		220	RM44182A1	44182A1	217
REC8M6001252	8M6001252	169			226-227-236-	RM45-41629A2	41629A2	279
REC8M6002274		107			237-238-239	RM45-41629A2	45-41629A2	281
REC8M6002428	8M0057686	130	RECKITMALPHA1AL	888756Q04	108-258-259-	RM45-41629A2	805370A1	283
REC8M6002428	8M6000652	130	RECKITMALPHA1M	888756Q04	263-267-284-	RM45-812773T	45-812773T	277
REC8M6002428	8M6002428	130	RECKITMALPHA1ZN	888756Q04	286	RM46-807151A8	46-72774A69	185
REC8M6003194	878187	145	RECKITMALPHA2AL	888756Q03	284-286	RM46-807151A8	46-807151A8	185
REC8M6003194	8M6003194	145	RECKITMALPHA2M	888756Q03	284-286	RM52-865344A01	52-865344A01	277
REC8M6500024	865598	194	RECKITMALPHA2Z	888756Q03	108-109-269-	RM53-87843	53-87843	185-294-295-
REC8M6500024	8M6500024	193	RECKITMALPHA2Z	888756Q03	271-275-284-	RM53-87843		297
REC9-33301	885176	131-149-150	RECKITMALPHA2M	888756Q03	286	RM54-12078	54-12078	293-298
REC9-33302	861260	131	RECKITMALPHA2Z	888756Q03	284-286	RM57-862054Q		104-195
REC9-33302	861260T	131	RECKITMBRAVO1AL		109	RM57410	57410	283
REC9-33302		149-150	RECKITMBRAVO1AL	888758Q02	276-277-279-	RM805182A1	805182A1	283
REC9-33303	805225A1	131-149-150	RECKITMBRAVO1M	888758Q02	284-286	RM805322	805322	283
REC9-33304	849896	131	RECKITMBRAVO1M	888758Q02	284-286	RM806031A2	806031A2	295
REC9-33304	802632T	131-150	RECKITMBRAVO1ZN	888758Q02	284-286	RM806034A2	806034A2	293-298
REC90095		310	RECKITMBRAVO23AL	888761Q03	109-281-284-	RM806193A48	19742A1	185
REC90301-ZW1-003	11-827614	263-267-275-	RECKITMBRAVO23M	888761Q03	286	RM806193A48	19742A3	185
REC90490	91-17257T	279	RECKITMBRAVO23Z	888761Q03	284-286	RM806193A48	806193A20	185
REC90490	91-8053741	314	RECKITMBRAVO3AL	888761Q04	284-286	RM806193A48	806193A38	185
REC90508-ZW1-003	14-816629Q	267-275-279	RECKITMBRAVO3AL	888761Q04	108-109-283-	RM806193A48	806193A48	185
REC90508-ZW1-003	816629Q	263	RECKITMBRAVO3M	888761Q04	284-286	RM807130A4	44266T	250
REC90736A24	90736A24	177	RECKITMBRAVO3ZN	888761Q04	284-286	RM807130A4	44266T1	250
REC908855	26-20070	216	RECMC00001		189	RM807130A4	807130A4	227-229-233-
REC909140	25-58390	215	RECMC00002		189	RM807130A4		237-239-250
REC91-00001		310	RECMC00004	47-89984Q5	190	RM807130A4	8M0115149	231-250
REC91-00002		310	RECOBBRACKET		110	RM807371T1	807371T1	184
REC91-12037	91-12037	313	RECPG260		151	RM815932	815932	269-271
REC91-17256	91-17256	314	RECPIN4		310	RM817275A1	817275A1	273
REC91-25034		292-311	RECPIN4.5		310	RM863444T1	863444T1	179
REC91-31107T	91-17275A1	313	RECPIN6		310	RM863457A2	863457A2	178
REC91-31229		313	RECRK21069		123	RM863631T1	863631T1	179
REC91-34569A1		310	RECSWK-2000/10		119	RM864363A1	864363A1	292
REC91-36569T	91-36569T	310	RECSWK-2000/5		119	RM864364A1	864364A1	292
REC91-37241		310	RECTOOLTRIM1		310	RM865328A01	865328A01	293
REC91-43506T		311	RECTOOLTRIM2		310	RM865425A03	865425A03	277
REC91-43579	91-43579	313	RECTOOLTRIM3		310	RM865470	865470	296
REC91-45497A1	91-45497A1	312	RECTOOLTRIMKIT		310	RM865470	865470	296
REC91-56048001	91-56048001	312	RM10-25299	10-824941	219-221-225-	RM866136A01	866136A01	277
REC91-56775T	91-56775T	312	RM10-28635	10-28635	235	RM866322A01	866322A01	293-298
REC91-60523	91-60523	312	RM10-807204	10-807204	293-298	RM86739	86739	283
REC91-60526T	91-60526T	312	RM11-49910	11-49910	293-298	RM86739	14-86739	279-281
REC91-61067A04		311	RM11-92004	11-92004	292	RM86754T	86754T	283
REC91-61069T		311	RM12-41721	12-41721	277	RM88-79023A91	88-79023A91	158
REC91-61077T	91-61077T	312	RM12-98548	12-98548	293-298	RM8M0052936	87-808009A1	292
REC91-78310	91-78310	312	RM14801A1	14801A1	293-298	RM8M0052936	87-808009A3	292
REC91-805475A1	91-805475A1	312	RM1656-8866A17	8866A64	233-237-249	RM8M0052936	87-8M0052936	292
REC91-818162	91-818162	312	RM19543A10	865436A02	279	RM8M0062440	8M0062440	298
			RM21325765	864148	292-300	RM91-17273	91-17273	313
					143	RM91-17275A1	91-17275A1	313



REF	OEM	
RM91-17302	91-17302	313
RM91-31229A7		311
RM94989A6	94989A6	291
RM97351	97351	277
RM99356A1	99356A1	184
RM99438A1	99438A1	183
<b>S</b>		
SED3092000	805602A1	247
SED3092600	807988A03	239-247
SED3092600	807988A3	227
SED3092600		237
SED3092610	12076A2	247
SED3092610	12076A2	221-222
SED3093300	805602A2	247
SED3093301	80176320	247
SED3095400	864309T02	229-233-247
SED3095500	807988A03	247
SED3095500	864591T02	229-233
SHE10615K	47-879312025	107-186-188
SHE15000K	3349198	188
SHE15000K	3916720	188
SHE15000K	47-853126	188
SHE15000K	8M0056956	188
SHE15000K		107-186
SHE15979	47-808145T	186-191
SHE26000K	3972366	186-188
SHEG151	805835	186
SHEG155	806152	186
SHEG2603X		186
SHEP1016	854179001	186
SHEP1016	879312023	186
SHEP1016	8M0148530	186
SOL1511-142-23	48-78126A45	316
SOL1511-143-21	48-832834A45	316
SOL1511-145-19	48-832832A45	316
SOL1511-148-17	48-832830A45	316
SOL1511-150-15	48-832828A45	316
SOL1511-153-19	48-13700A46	316
SOL1511-153-21	48-13702A46	316
SOL1511-153-23	48-13704A46	316
SOL1511-155-17	48-18278A46	316
SOL1511-158-15	48-19838A46	316
SOL1511-160-13	48-78114A45	316
SOL1511-160-13	48-826072A46	316
SOL1512-153-19	48-13701A46	316
SOL1512-153-21	48-13703A46	316
SOL1512-155-17	48-90159A46	316
SOL1512-158-15	48-19841A46	316
SOL1513-140-21	48-832832A45	316
SOL1513-140-21	48-834854A45	316
SOL1513-140-23	48-832834A45	316
SOL1513-143-19	48-832830A45	316
SOL1513-143-19	48-834852A45	316
SOL1513-145-17	48-831850A45	316
SOL1513-145-17	48-832828A45	316
SOL1513-148-15	48-78116A4	316
SOL1514-140-21	48-834855A45	316
SOL1514-143-19	48-834853A45	316
SOL1514-145-17	48-834851A45	316
SOL1531-140-19	48-16316A46	316
SOL1531-140-19	48-832830A45	316
SOL1531-140-21	48-16318A46	316
SOL1531-140-21	48-832832A45	316
SOL1531-140-23	48-16320A46	316
SOL1531-140-23	48-832834A45	316
SOL1531-140-25	48-16322A46	316
SOL1531-140-25	48-78126A45	316
SOL1531-143-17	48-16314A46	316
SOL1531-143-17	48-832828A45	316
SOL1531-145-15	48-16312A46	316
SOL1531-145-15	48-78116A4	316
SOL1531-156-13	48-78114A45	316
SOL1532-140-19	48-16317A46	316
SOL1532-140-21	48-16319A46	316
SOL1532-140-23	48-16321A46	316
SOL1532-143-17	48-16315A46	316
SOL1551-140-24	48-16322A46	316
SOL1551-140-24	48-16550A46	316
SOL1551-143-22	48-16320A46	316
SOL1551-143-22	48-16548A46	316
SOL1551-145-21	48-16546A46	316
SOL1551-148-16	48-16314A46	316
SOL1551-148-18	48-16316A46	316
SOL1551-148-19	48-16544A46	316
SOL1551-148-20	48-16318A46	316
SOL1552-140-24	48-16549A46	316
SOL1552-143-22	48-16321A46	316
SOL1552-143-22	48-16547A46	316
SOL1552-145-21	48-16545A46	316
SOL1552-148-16	48-16315A46	316
SOL1552-148-18	48-16317A46	316
SOL1552-148-19	48-16543A46	316
SOL1552-148-20	48-16319A46	316
SOL1571-145-25	48-13706A46	316
SOL1571-148-23	48-13704A46	316
SOL1571-150-21	48-13702A46	316
SOL1571-153-19	48-13700A46	316

REF	OEM	
SOL1571-155-17	48-18278A46	316
SOL1572-145-25	48-13707A46	316
SOL1572-148-23	48-13705A46	316
SOL1572-150-21	48-13703A46	316
SOL1572-153-19	48-13701A46	316
SOL1572-155-17	48-90159A46	316
SOL1611-178-21	48-18616A40	316
SOL1611-178-21	48-18616A6	316
SOL1611-183-19	48-18614A40	316
SOL1611-183-19	48-18614A6	316
SOL1611-188-17	48-18612A40	316
SOL1611-188-17	48-18612A6	316
SOL1611-193-15	48-18610A40	316
SOL1611-193-15	48-18610A6	316
SOL1612-178-21	48-18617A40	316
SOL1612-178-21	48-18617A6	316
SOL1612-183-19	48-18615A40	316
SOL1612-183-19	48-18615A6	316
SOL1612-188-17	48-18613A40	316
SOL1612-188-17	48-18613A6	316
SOL1612-193-15	48-18611A40	316
SOL1612-193-15	48-18611A6	316
SOL1641-173-25	48-18620A6	316
SOL1641-175-23	48-18618A40	316
SOL1641-175-23	48-18618A6	316
SOL1641-175-23	48-18620A40	316
SOL1641-178-21	48-18616A40	316
SOL1641-178-21	48-18616A6	316
SOL1641-183-19	48-18614A40	316
SOL1641-183-19	48-18614A6	316
SOL1641-188-17	48-18612A40	316
SOL1641-188-17	48-18612A6	316
SOL1641-193-15	48-18610A40	316
SOL1641-193-15	48-18610A6	316
SOL1642-173-25	48-18621A40	316
SOL1642-173-25	48-18621A6	316
SOL1642-175-23	48-18619A40	316
SOL1642-175-23	48-18619A6	316
SOL1642-178-21	48-18617A40	316
SOL1642-178-21	48-18617A6	316
SOL1642-183-19	48-18615A40	316
SOL1642-183-19	48-18615A6	316
SOL1642-188-17	48-18613A40	316
SOL1642-188-17	48-18613A6	316
SOL1642-193-15	48-18611A40	316
SOL1642-193-15	48-18611A6	316
SOL1651-138-28		317
SOL1651-140-24		317
SOL1651-140-25		317
SOL1651-140-26		317
SOL1651-140-27		317
SOL1651-143-22		317
SOL1651-143-23		317
SOL1651-144-20		317
SOL1651-144-21		317
SOL1654-150-28		317
SOL1654-155-24		317
SOL1654-155-25		317
SOL1654-155-26		317
SOL1654-155-27		317
SOL1654-158-22		317
SOL1654-158-23		317
SOL1654-160-20		317
SOL1654-160-21		317
SOL9511-143-21		317
SOL9511-145-19		317
SOL9511-148-17		317
SOL9511-150-15		317
SOL9511-153-13		317
SOL9512-143-21		317
SOL9512-145-19		317
SOL9512-148-17		317
SOL9512-150-15		317
SOL9513-140-21		317
SOL9513-143-19		317
SOL9513-145-17		317
SOL9513-148-15		317
SOL9531-140-19		317
SOL9531-140-21		317
SOL9531-140-23		317
SOL9531-143-17		317
SOL9531-145-15		317
SOL9532-140-19		317
SOL9532-140-21		317
SOL9532-140-23		317
SOL9532-143-17		317
SOL9532-145-15		317
SOL9571-145-25		317
SOL9571-148-23		317
SOL9571-150-21		317
SOL9571-153-19		317
SOL9571-155-17		317
SOL9571-158-15		317
SOL9572-145-25		317
SOL9572-148-23		317
SOL9572-150-21		317
SOL9572-153-19		317
SOL9572-155-17		317

REF	OEM	
SOL9572-158-15		317
SOLRBX-102		317
<b>T</b>		
TEN00800	1301339	286
TEN00806BIS	821521	286
TEN00807	55989	286
TEN00814	821629	286
TEN00815	821630	286
TEN00817	806189	287
TEN00818	806190	287
TEN00819	806105	287
TEN00820	76214-5	286
TEN00823	823912	286
TEN00824	823913	286
TEN00827	17264	286
TEN00839	853762	287
TEN01320T	811487	287
TEN01320T	879194217	287
TEN01320T	8M0067062	287
TEN01320T	8M0067625	287
TEN01320T	8M0150234	287
TEN01320T	97-8M0151541	287
TEN01320T		107-183
TEN02040		287
TEN02041		287
TEN02042		287
TEN02043		287
TEN02043T		287
TEN02044		287
TEN02044T		287
TEN02044TP		287
TENKITALPHAONE/1	8887562Q02	263-267-287
TENKITALPHAONE/2	888756Q01	287
TENKITALPHAONE/2	888756Q03	287
TENKITALPHAONE/2		269-171-175
TENKITBRAVOI	888758Q01	279-287
TENKITBRAVOII-III	888761Q01	281-287
TENKITBRAVOIII-04	888761Q02	283-287
TRANSONALPHA2G	6-6111002LP	291
TRANSONALPHA1	6-6010000CP	291
TRANSONBRAVO	6-6211002NZ	298
TRANSONBRAVO	6-6311002NZ	298

# OEM --> REF

OEM	REF	PAG.	OEM	REF	PAG.	OEM	REF	PAG.
6325	REC33662	170	62898	BAMC29-62898	180	807652	REC807652T	154
12449	REC3860769	153	63196	REC86247T	124	807653	REC807653T	154
12708	REC12708	277	64850	REC71831	170	808483	REC3854548	168
12711	REC12711	277-302	65864	REC65864	169	808484	REC3854549	169
12784	REC12784	277	69729	REC69729	153	808500	REC808500	129
13037	REC13037	157	70125	REC70125A02	142	808504	REC65L-13915-00	113
13171	REC12-835467Q01	281	71327	REC86234A4	124	809064	REC809064	138-140-141
13220	REC13220	138	71464	REC71464A01	142	809065	REC809065	138
15995	REC15995	148-224	71646	REC86246T	124	809066	REC809066	142
17264	TEN00827	286	72608	MP425149	254	811091	REC806490T	148
17649	REC891736T	156	72625	REC71464A01	142	811406	REC803623001	160
19685	REC3860769	153	73379	REC22-73379	231-234	811461	REC25-811461	143
25661	REC378444	157	75416	FEDV-3929	217	811487	TEN01320T	287
32734	CEF500512K	300	75832	REC3850812	277	811534	REC811534	136-140-141-142
32734	REC18654A1	300	76214	REC76141T	285	811536	REC811536T	136
33266	REC195141	176	76214	REC76141T1AL	285	811575	MP425113	254
33662	REC33662	170	76214-4	REC762144	285	811636	REC3854261	169
33700	REC33700	170	76214-4	REC762144AL	285	811637	REC3854003	162
33706	REC33706	170	76865	REC76865	263-267-275	811639	REC3854001	145
33708	REC33708	168	77123	REC77123	293	814605	REC814605	275
33765	REC33765T	168	77594	REC86234A4	124	815425	REC8M0068784	147
33863	MP514693	193	78016	REC65864	169	815932	RM815932	269-271
34127	REC34127T2	285	78402	REC78403A2	153	816607	REC816607	295
34127	REC34127T2AL	285	78458	CEF500520K	300	816685	REC816685	295-302
34235	REC34235T	170	78458	REC78458A1	300	817119	REC3860769	153
34623	REC8M0068784	147	78485	REC86246T	124	817377	REC817377	173-176
34625	REC97258A1	148	78820	REC86247T	124	817378	REC3854003	161
35852	GS38122	303	79448	REC8M2011027	281	821509	REC882751A04	158
35915	REC35915	263	85060	REC85060	306-307-308	821521	TEN00806BIS	286
35983	REC35983	259	85538	CMX-1	288	821629	TEN00814	286
35983	REC35983	269	85538	CMX-1A	288	821630	TEN00815	286
35983	REC35983	271	86234	REC86234A4	124	823341	CMX-1	288
36223	CEF500522K	299	86246	REC86246T	124	823341	CMX-1A	288
36223	REC36223A2	299	86247	REC86247T	124	823727	REC823727	136-140-141
36525	REC806490T	148	86739	RM86739	283	823728	REC809065	138
38547	REC1463-9382	162	87581	REC195141	176	823912	TEN00823	286
39916	BAMC47-27-39923	250	88035	REC88035	306	823913	TEN00824	286
39920	BAMC-20-55538	245	90806	REC8M0068784	147	824324	MP425024	254
41471	PAGB/T93-10	231	92916	REC23-8M8000506	281	824330	MP425036	254
41802	REC41802	227	94286	REC94286T1	285	827682	REC827682T	126
41802	REC41802	229	94286	REC94286T1AL	285	828151	REC3854138	158
41802	REC41802	233	94576	REC94576	192	828358	REC8M0082988	146
41802	REC41802	237	94916	REC94916	192	834832	REC8M0064021	154
41802	REC41802	239	97258	REC97258A1	148	835076	REC809065	138
41802	REC41802	291	97351	RM97351	277	849896	REC9-33304	131
41802	REC41802	296	97399	REC862048A1	124	849899	REC849899	130-150
42785	REC42785	155	97401	REC8M0058164	125	849934	REC879150150	144
43436	REC43436	292-303	98555	REC3860769	153	850484	REC3854331	168
43557	REC805759Q01	168	98794	REC10-98794	231	850485	REC3854311	169
43713	REC43713	291-296	99757	REC27-99757	231	850485	REC3854311	173
43994	REC43994A2	285	195141	REC195141	176	850487	REC3854003	162
43994	REC43994A2AL	285	324351	REC324351	261-265	853635	REC853635	271
46335	REC46335	219-221-222-224-225-227-235-237-239	393831	REC393831	269	853678	REC853678T	144
46399	REC46399	285	393831	REC393831	271	853762	TEN00839	287
46399	REC46399AL	285	428611	REC22-428611	231-234	853998	REC853998A1	131
46860	REC86247T	124	479452	PAF15-07010004	229	854445	REC854445	144-150
47585	REC86234A4	124	621041	REC621041	259-295-302	859135	REC11-859135	194-269
47587	BAMC29-47587	177	668631	REC10-668631	231-234	859210	REC881879T11	147
47735	BAMC1-47735	244	681001	REC681001	267-275	860231	REC27-8637251	251
47736	BAMC1-47736	244	774811	REC774811	261-265	861249	REC861249A1	144
47820	REC47820A1	285	801766	REC801766	171	861259	REC861259	142
47820	REC47820A1AL	285	801767	REC801767	171	861260	REC9-33302	131
48952	REC48952	148	801768	REC801768	171	861578	REC861578	292
52352	REC195141	176	802464	REC802464	162	861579	REC861579	186
53051	REC27-53045Q01	181	802630	REC802630T01	129	861579	REC861579	192
53114	CEF500524	253	802632	REC802632T	130	862031	REC862031T1	153
53114	REC53114A1	253	803148	REC803148	144-149-150	862209	REC862209	297
54552	REC62092T	124	803149	REC3843751	145-149-150	862646	BS5292	159
55989	TEN00807	286	803623	REC803623001	160	862647	BS5294	159
56045	REC69729	153	804412	REC3854003	162	862998	REC862998	145
56153	REC3853847	217	804418	REC3854548	168	863725	REC27-8637251	251
57410	RM57410	283	804424	REC3854311	169	864148	RM21325765	143
58033	REC58033	170	805100	REC805100	283	864297	REC864297T01	146
58034	REC64851	170	805218	REC3850397	148	864493	REC864493	181
58217	REC58217	169	805223	REC805223T	148	864572	REC864572	112
58231	REC195141	176	805322	RM805322	283	865182	REC865182Q01	285
59498	BAMC29-59498	180	805835	SHEG151	186	865182	REC865182Q01AL	285
59503	REC59503	191	805884	REC805884T	153	865193	REC865193	194
59755	REC69729	153	806105	TEN00819	287	865470	RM865470	296
59974	MP425113	254	806152	SHEG155	186	865598	REC8M6500024	194
60207	REC60207	235-241	806188	REC806188Q01	285	866725	REC22-866725	231-234
60565	REC35-06007	114	806188	REC806188Q01AL	285	878187	REC8M6003194	145
60930	REC60930	253	806189	TEN00817	287	879172	REC879172	120
62092	REC62092T	124	806190	TEN00818	287	881731	REC8M0054726	144
62424	REC195141	176	806490	REC806490T	148	882376	REC882376	116
						882481	REC879194371	152



OEM	REF	PAG.	OEM	REF	PAG.	OEM	REF	PAG.
882571	REC882571	154	881693002	REC881693002	130-150	11-862907	REC11-862907	283
882687	REC882687	122	881879010	REC8M6000623	148	11-863332	REC11-863332	304
882751	REC3854138	158	881879011	REC881879T11	147	11-8M0105210	REC11-8M0105210	283
883885	REC3853796	186-187	885342001	REC8M0148668	148	11-92004	RM11-92004	277
883925	REC46-8M0113736	185	885342002	REC8M0148668	148-231-234	12-18448	REC12-18448	275
884727	REC46-8M0113733	185	889659002	REC8M6000634	147	12-19183-3	REC12-191833	283
884790	REC898253013	169	892615001	REC892615002	146	12-191833	REC12-191833	259-263-267-269-271-275-277-279-281
884792	REC898253T22	169	892615002	REC892615002	146	12-20084	REC12-20084	192-219-221-222
885165	REC8M0087834	144	896332057	REC896332057	193	12-27880	REC12-27880	261-265
885174	REC885174	130-149-150	896332148	REC8M0093561	181	12-29245	PAGB/T848-6	261-265
885176	REC885176	130-149-150	896332162	REC879172	120	12-31211A2	REC12-31211Q03	275
885176	REC9-33301	131-149-150	896332191	REC879172259	152	12-31211Q03	REC12-31211Q03	263-267-279
888731	REC898253T23	169	897345016	REC8M0155633	186	12-31266	REC12-31266	261-265
889333	BAMC29-63588	178	897447002	REC8M6000634	147	12-32666	REC12-32666	259-295
889341	REC8M0098619	143	898101425	REC8M0111642	193	12-32834	REC12-32834	304
889419	REC889419	117	898101505	REC898101505	153	12-35777	REC12-35777	304
889422	REC889422	117	898253003	REC33662	170	12-35935	REC12-45176	269-271-295-297
892615	REC892615002	146	898253005	REC33662	170	12-36001	PAGB/T97.1-8	192-261-265
892617	REC892617	146	898253007	REC58033	170	12-39116	REC12-39116	295
892665	REC35-892665	128	898253008	REC58217	169	12-41721	RM12-41721	293-298
892681	REC892681	128	898253009	REC8M6001252	169	12-44163	REC12-44163	306-308
892681	REC892681	130	898253010	REC3854549	169	12-44164	REC12-44164	308
892683	REC26-892683	128	898253011	REC3854261	169	12-45176	REC12-45176	257-283
895207	REC895207	107-122-184	898253012	REC3854311	169	12-45810	REC12-45810	259-269-271
898141	REC3863130	146-175	898253013	REC898253013	169	12-46765	REC12-46765	305
934231	REC934231	263-267	898253029	REC89825302	169	12-72498	REC12-72498	295
934241	REC934241	263-267	10-20518	REC10-20518	292-303	12-815472	REC12-815472	292
1301339	TEN00800	286	10-28635	RM10-28635	293-298	12-815952	REC12-815952	307
2495186	REC46-48748T1	189	10-28636	REC10-28668	291	12-835467Q01	REC12-835467Q01	263-267-275-279
2763441	REC46-48748T1	189	10-28668	REC10-28668	259-271	12-85058	REC12-85058	306
3349198	CEF500167	188	10-28688	REC10-28668	269	12-8M0042641	REC8M0042641	261
3349198	REC15000K	188	10-30206	REC10-30206	263-267	12-90931	REC12-90931	174
3349198	SHE15000K	188	10-31700	REC10-31700	292-302	12-92721	REC350038	267
3581760	REC3581760	117	10-32470	REC10-32470	263-267	12-92721	REC350038	275
3854260	REC3854260	173	10-34354	REC10-34354	221	12-98548	RM12-98548	293-298
3854331	REC3854331	173	10-35386	REC10-35386	219-235-240-241	12076A2	MAR076	221-222-245-251
3854548	REC3854548	173	10-37562	REC10-37562	225	12076A2	SED3092610	247
3916720	CEF500167	188	10-37612	REC10-37612	239-240-241	12076A2	SED3092610	221-222
3916720	REC15000K	188	10-37612	REC10-37612	239-240-241	12632A7	REC12632A7	304
3916720	SHE15000K	188	10-43749	REC10-43749	227-229-233-237-239	12644A1	REC12644A1	254
3938311	REC393831	259	10-45590	REC10-45590	295-302	13-33734	REC13-33734	304
3972366	CEF500183G	188	10-53728	REC10-53728	221-222	13-35048	REC13-35048	221-224-227-229-233-235-237-239-240-241-277
3972366	SHE26000K	186-188	10-53728	REC10-53728	221-222	13-39107	REC13-39107	224
8079821	REC27-8079821	137	10-668631	REC10-668631	221	13-42351-1	REC13-423511	263-279
8084841	REC3854549	169	10-72094	REC10-72094	221	13-423511	REC13-423511	267-275
8085041	REC65L-13915-00	113	10-73657	REC10-73657	224	13-69432	REC304454	307-308
8116361	REC3854261	169	10-74727	REC22-73379	224	1336-3594A1	REC1347-818619R02	133
8168112	REC8168112	259-269-271	10-76156	REC10-76156	263-267	13447A1	REC17177A1	175
8172761	REC8172761	273	10-79953Q04	REC10-79953Q04	259-269-271	1347-6492A1	REC1347-816373A4	134
8183812	REC8M0113182	194	10-806290	REC10-806290	307-308	1347-6493A1	REC804626R02	132
8245191	REC8245191	265-273	10-806327	REC10-806327	275-279-281-283	1347-7361A1	REC1347-9661A3	132
8283582	REC8M0082988	146	10-807204	RM10-807204	293-298	1347-7362A1	REC1347-816373A4	134
8503991	REC46-8M0113734	185	10-812509184	MPO180-001	152	1347-7363A1	REC804626R02	132
8504541	REC46-8M0113735	185	10-816601	REC10-816601	269-271-283	1347-7364A1	REC1347-9661A3	132
8504851	REC3854311	169	10-816928	REC10-816928	273-223	1347-7366A	REC804626R02	132
8507522	REC8507522	302	10-824941	RM10-25299	225-235	1347-804623R1/02	REC3304-9354A2	132
8623405	REC86234A4	124	10-85486	REC10-85486	306-307-308	1347-804624R02	REC1347-816373A4	134
8733261	REC13037	157	10-861788	REC10-861788	151-152	1347-804626R1	REC804626R02	132
8818793	REC8M6000623	148	10-865321	REC313715	283	1347-816373A4	REC1347-816373A4	134
14358001	REC32-14358001	231	10-865982005	REC10-865982005	227-237-239	1347-818619R02	REC1347-818619R02	133
44348001	REC32-44348001	231	10-86801	REC10-86801	293-298	1347-8186191	REC1347-818619R02	133
80176320	SED3093301	247	10-90926	REC10-90926	174	1347-8186211	REC1348-818621R02	132
81637002	REC3854003	162	10-96411	REC10-96411	265	1347-8186221	REC1376-818622R02	133
82671013	REC11-862903	305	10-97934	REC10-97934	304	1347-8288A1	REC804626R02	132
801331174	RM21325765	143	10-97934A1	REC10-97934A1	292-304	1347-8291A3	REC804626R02	132
801763272	RM21325765	143	10-98794	REC10-98794	229-233-259-269-271	1347-8292A4	REC1347-816373A4	134
802630001	REC802630T01	129	11-13436	REC11-13436	261-265	1347-8296A4	REC1347-9661A3	132
803623001	REC803623001	160	11-134371	REC11-862903	293-298	1347-9415T	REC1347-816373A4	134
811637001	REC3854003	162	11-134391	REC11-34933	295	1347-9661A3	REC1347-9661A3	132
811637001	REC3854003	173	11-22339	REC11-22339	259-269-271-277	1347-9662A4	REC1347-816373A4	134
815504272	GS38320	231	11-34933	REC11-34933	291-296	1347-8296A4	REC1347-9661A3	132
854179001	SHEP1016	186	11-35921	REC11-35921	263-267-275	1347-9415T	REC1347-816373A4	134
861526001	REC821526001	273	11-46335	REC46335	240-241	1347-9661A3	REC1347-9661A3	132
864297001	REC864297T01	146	11-49910	RM11-49910	292	1347-9662A4	REC1347-816373A4	134
879150150	REC879150150	144	11-52707Q1	REC11-52707Q1	263-267-275-279	1348-818621R02	REC1348-818621R02	132
879172105	REC3843100	147	11-8267089	REC11-8267089	261-265-296	1351-4263A1	REC1347-818619R02	133
879172259	REC879172259	152	11-827614	REC90301-ZW1-003	263-267-275-279	1351-4263A2/A3	REC1347-818619R02	133
879194185	REC879194185	184	11-859116	REC11-34933	259-263-267-283-297-306-308	1351-5202A1	REC1347-818619R02	133
879194215	REC8M0093561	181	11-859124	REC11-859124	263-267	1351-6065A2	REC1347-818619R02	133
879194217	TEN01320T	287	11-859135	REC11-859135	271	1351-7354A1	REC1347-818619R02	133
879194231	REC8M0093561	181	11-862902	REC11-862902	219-221	1351-8480A2	REC1348-818621R02	132
879194233	REC8M0093561	181				13524A1	REC13524A1	169
879194241	REC016940	121						
879194363	REC21124849	146						
879194371	REC879194371	152						
879312023	SHEP1016	186						

OEM	REF	PAG.	OEM	REF	PAG.	OEM	REF	PAG.
13524A4	REC13524A6	169	16-97520	REC16-97520	235	22-866725	REC22-866725	221-224-229-233-235-237-239-241-241
13524A5	REC13524A1	169	1623-5356A4	REC1623-5356A4	256-261	22-88847A1	REC22-88847A1	291-296
13524A6	REC13524A6	169	1623-815822A30	REC1623-815822A30	257-273	22-89771Q2	GS31066	112
13524Q06	REC13524A6	169-174	1623-815822A32	REC1623-815822A32	257	22-8M0058389	REC22-67892A05	283
13524T1	REC13524A1	169-174	1623-815822A43	REC1623-815822A43	257	22-98477A2	REC22-98477A2	179
13753A2	REC815407A2	168	1623-815822A45	REC1623-815822A45	257	23-29804T	REC23-29804T	261-265
1376-5659A1	REC1376-818622R02	133	1623-815822A47	REC1623-815822A47	257	23-30617A2	REC23-30617A2	261-265
1376-5744A1	REC1376-818622R02	133	1623-815822A53	REC1623-815822A53	257	23-32632	REC23-32632	259
1376-6152A1	REC1376-818622R02	133	1623-815822A6	REC1623-815822A6	257	23-67370	REC23-67370	273
1376-818622R02	REC1376-818622R02	133	1623-815823A5	REC1623-815822A53	257	23-805041A2	REC23-805041A2	295-303
1389-9562A1	REC3310-860070A2	135	1623-8951A33	REC1623-8951A33	256	23-806036A1	REC23-806036A1	295-303
1389-9670A2	REC3310-807312A1	133	1623-8951A37	REC1623-8951A37	256-265	23-806922	REC23-806922	178-180
1396-4148	REC1396-4148	142	1623-8951A43	REC1623-8951A43	256	23-807073	REC23-807073	308
1396-4656	REC1396-4656	138	16457A4	REC805759Q01	168	23-815921A17	RM23-815921A17	272-273
1396-5222	REC1396-5238	139	1656-8866A55	REC1656-8866A55	255	23-815921A21	REC23-815921A21	273
1396-5238	REC1396-5238	139	1656-8866A63	REC1656-8866A63	255	23-8159501	REC23-8159501	307
1397-2060	REC1397-2060	136-139-140-141	1656-8M0046682	REC1656-8M0046682	255	23-816583	REC23-816583	257-273
1397-2067	REC823427A1	137	1656-8M0046733	REC1656-8M0046733	255	23-816599	RM23-816599	291
1397-2150	REC1397-2150	113	1656-8M0046735	REC1656-8M0046735	255	23-824108	REC23-824108	267-275
1397-2634	REC823427A1	137	1656-8M0046738	REC1656-8M0046738	255	23-847637	REC23-847637	293-298
1397-3327	REC1397-3327	136	16755Q1	REC16755Q1	276-277-197-199	23-847638	RM23-847638	298
1397-3459	REC823427A1	137	16755Q1	REC86310	277	23-853853002	REC23-853853002	217
1397-5830	REC1397-8760	137	16792A39	REC16792A39	292	23-853855001	REC23-853855001	217
1397-5831	REC1397-5831	139-141	17-14872A1	REC17-14872A1	141-306	23-861209A1	REC23-861209A1	277-297-303
1397-5837	REC3302-9031	136	17-14872A1	REC21380	306	23-87560091	RM23-87560091	277
1397-6367A1	REC1397-6367A1	138	17-14873A1	REC17-14873A1	306	23-87560094	RM23-87560094	277
1397-7099	REC1397-8760	137	17-14873A1	REC21370	306	23-87560097	RM23-87560097	277
1397-7542	REC823427A1	137	17-35973	REC331880	267	23-89574	REC23-89574	305
1397-7547	REC823427A1	137	17-44166	REC17-44166	308	23-90915	REC23-90915	174
1397-8545	REC1397-8767Q	112	17-44166T1	REC14-44166T1	308	23-92916	REC23-8M8000506	279-283
1397-8546	REC1397-3327	136	17-44167A1	REC17-44167A1	308	23-98356	RM23-98356	291-296
1397-8582	REC1397-8582	142	17-47617	REC17-47617	174	23-983571	RM23-983571	291-296
1397-8760	REC1397-8760	137	17-815953A01	REC17-815953A01	307	23-99291T	REC23-99291	306
1397-8767	REC1397-8767Q	112	17-8M0073409	REC17-8M0073409	296	23-99299	REC23-99299	304
1397-8767Q	REC1397-8767Q	112	17177A1	REC17177A1	175	23-99322	REC23-99322	292-304
1397-8872	REC823427A1	137	17494A1	REC17494A1	180	23-99352	RM23-99352	293-298
1397-8873	REC823427A1	137	17649T	REC891736T	156	24-17997A1	REC24-17997A1	269-271-277
1397-8959	REC1397-3327	136	18-32665	REC18-32665	259-295	24-30893	REC24-30893	267-275
1398-3089	REC1398-3089	138	18525A1	REC18525A1	156	24-30893	REC31-30893	263
14-18323	REC14-18323	267-275-279-281	18643A7	REC18643A7	304	24-803192A2	REC27-803192A2	187
14-79447	REC14-79447	263	18654A1	CEF500512K	300	24-8M0094247	REC27-8M0094247	143
14-816629Q	REC90508-ZW1-003	267-275-279	18654A1	REC18654A1	295-297-300	25-16524	REC25-16524	215
14-86739	RM86739	279-281	18920A1	REC18920A1	295-297	25-20081	REC25-20081	215
14034A3	REC14034A3	306	19-14842	REC19-14842	306-308	25-20415	REC25-16524	215
14035A3	REC14035A3	306	19-42682	REC19-42682	259	25-20826	REC308627	215-279-281-283
14336A20	REC865380A13	155	19-47579	REC19-47579	259	25-20862	REC25-20862	215
14336A8	REC865380A13	155	19-59504	REC19-59504	192	25-21836	REC25-21836	215-273
14336A9	REC865380A25	155	19-815951	REC19-815951	307	25-25439	REC25-25439	215-259-261-265-269-271
14348A1	REC807166A3	253	19-864689	REC19-864689	229-233	25-26543	REC333572	215
14478T	BAMC-20-14478	249	19405A4	REC13524A6	169	25-26722	REC302588	215
14478T01	BAMC-20-14478	227-230-237-239-249	19742A1	RM806193A48	185	25-26802	REC25-8M0084884	183
14505A2	REC14505A2	304	19742A3	RM806193A48	185	25-26802	REC303347	215
14587A5	REC14587A7	267-275	21-20553	REC13-35048	219-221-222	25-26855	REC3852928	215
14801A1	RM14801A1	233-237-249	22-328022	REC22-328022	221-227-237-239-240-241-249	25-29439	REC309731	215
15-32563A1	REC15-32563A1	259-269-271	22-32803	REC22-32803	222-224-249	25-29845	REC25-29845	277
15-35980A1	REC15-35980A1	259-269-271	22-36382	REC22-36382	219-221-227-237-239-249	25-30224Q	REC25-30224	180
15-36178A02	REC15-36178A02	269-271	22-384071	REC22-384071	237	25-30271	REC25-30271	261-265
15-36178A02	REC15-36178A02	259	22-41622	REC22-41622	221-227-235-237-239-240-249	25-30529	REC25-30529	215
15-42637A1	REC15-42637A1	265-273	22-428611	REC22-428611	224-227-229-233-237-239-259-296	25-30613	REC25-30613	215-261-265
15-44491A1	REC15-44491A1	275	22-43828T	RM22-43828	296	25-31305	REC553126	215
15-45691A1	REC15-45691A1	259-269	22-49718	RM22-49718	305	25-31534	REC25-31534	263-267-275-279-281
15-47397A1	REC15-47397A1	263-267-275	22-67892	REC22-67892A05	281	25-31986	REC3852866	215
15-57007A1	REC15-57007A1	261	22-73379	REC22-73379	227	25-32509	REC304174	215
15-71013	REC15-71013	259-269-271	22-73379	REC22-73379	227	25-32546	REC25-32546	215-259-269-271
15-86749A1	REC15-86749A1	279-281-283	22-806608A1	REC13980	229-233-237-239-291	25-33145	REC25-33145	215-261
15-92914A1	REC15-92914A1	279-281	22-860382	REC22-860382	295	25-33465	REC25-33465	192-215-279-283
1547-815930A7	REC1547-815930A7	257-269-271	22-861150A1	REC22-861150T02	185-295-297	25-33466	REC302537	215
1547-861063A10	REC1547-861063A10	257	22-861150A2	REC22-861150T02	185	25-33504	REC0307239	215-295
1547-861063A12	REC1547-861063A12	257	22-861150T02	REC22-861150T02	185	25-33756	REC305123	215
1547-861063A6	REC1547-861063A6	257	22-861163	RM22-861163	185-295-297	25-35027	REC25-35027	269-271-277
1547-861063A8	REC1547-861063A8	257	22-862210A01	REC862210A01	227	25-35029	REC25-35029	215
1547-9412A20	REC1547-9412A20	256	22-862210A01	REC862210A01	229	25-35276	REC310584	215
1547-9412A21	REC1547-9412A21	256	22-862210A01	REC862210A01	230	25-35480	REC321921	215
1547-9412A22	REC1547-9412A22	256	22-862210A01	REC862210A01	230	25-36318	REC25-36318	273
1547-9412A23	REC1547-9412A23	256	22-862210A01	REC862210A01	237	25-36318	REC301967	215
1589-865440H50	REC1589-865440H50	255	22-862210A01	REC862210A01	239	25-38099	REC25-38099	215-265
1589-865440H51	REC1589-865440H51	255	22-862210A01	REC862210A01	239	25-38101	REC25-38101	215
1589-865440H52	REC1589-865440H52	255	22-862210A01	REC862210A01	239	25-38933	REC25-38933	215
16-49545	REC16-49545	219-225-227-235-237-239-240-241	22-865417	REC22-865417	295-297	25-39695	REC326849	215
16-56826	REC16-56826	221				25-457101	REC25-457101	215-277
16-59579	REC16-59579	295-297						
16-70236	REC16-70236	219-221						
16-806300	REC16-806300	222						



OEM	REF	PAG.	OEM	REF	PAG.	OEM	REF	PAG.
25-45711	REC326649	215	26-805080	REC26-861694	216	27-68715	REC27-68715	217-224-252
25-47254	REC310414	215	26-805344	REC26-805344	279-281-283	27-70142	REC27-70142	137-139
25-48171	REC25-48171	215-295-297	26-807006	REC26-807006	216-277	27-70143	REC27-8079821	137
25-48452	REC302035	215	26-811554	REC26-811554	216	27-701431	REC27-8079821	137
25-54029	REC25-33465	215	26-814622	FELBSA0013	216-217	27-70905	REC27-70905	217
25-55682	REC26-55682	216	26-816464-1	REC26-8164641	273	27-72479A5	REC27-72479A5	217
25-55801	REC25-55801	215-259	26-8164641	REC26-8164641	216-261-265	27-72805	REC27-72805	125
25-58390	REC909140	215	26-816575A2	REC26-816575A2	273	27-73666	REC27-73666	217
25-62700	REC25-62700	215	26-816575A3	REC26-816575A3	272-273-278	27-73866	FEL17460	253
25-62704	REC3852045	215	26-821092	REC26-821092	216	27-73866	REC3852455	241
25-62705	REC25-62705	215-277-295-297	26-8219471	REC26-8219471	216-217	27-73866	REC3852455	253
25-62706	REC25-62706	277	26-823894	REC26-823894	216-259-269-271	27-74830	REC27-74830	180
25-62707	REC25-62706	215	26-861694	REC26-861694	283	27-801333454	REC27-8M0094247	143
25-64068	REC333572	215	26-864319	REC26-864319	271-273	27-8052151	REC27-8052151	192
25-65936	REC331188	215	26-88397	REC26-88397	269-271	27-805396	REC27-805396	137
25-67202	REC25-67202	215	26-88397A1	REC26-88397A1	269-271	27-805760	REC27-805760	174
25-67202	REC313175	215	26-88416	REC26-88416	291-296	27-807218	REC27-807218	219-221-225-250
25-70937	REC25-70937	215-259-269-271	26-892361	REC26-24590	216	27-807982	REC27-8079821	137
25-805331	REC3852865	215	26-89238	REC26-89238	216-261-265	27-8079821	REC27-8079821	137-221-222
25-805331	REC3852865	283	26-892683	REC26-892683	129	27-8146801	REC27-8146801	180
25-8071341	REC25-8M0084884	183	26-8M0033407	REC26-8M0033407	283	27-815528	REC27-815528	222-252
25-822370	REC25-33465	279-281	26-8M0050563	REC70817B	216	27-8172771	REC27-8172771	273
25-823683	REC25-823683	215	26-8M0150312	REC26-8M0150312	216	27-818832	REC27-863726	251
25-87400A2	REC25-87400A2	307-308	26-90562	REC26-90562	192-216	27-85046	REC27-850456	215
25-89497	REC25-89497	215	26-90925	REC26-90925	216-217	27-854129	REC27-8M0094247	143
25-89633	REC32126	183	26-94038	REC26-94038	216	27-856081	REC27-856081	261-265
25-896332077	REC32077	184	26-96063	REC26-897153	216	27-856704	REC27-856704	261
25-896332126	REC32126	183	26-965031	REC26-965031	216-259	27-856705	REC27-856705	224-251
25-8M0039163	REC25-8M0084884	183	26-97664	REC70817B	216	27-858524	REC27-858524	261-265
25-90011	REC25-90011	215-265-273	26-976641	REC70817B	216	27-860232	REC27-863726	251
25-94288	REC25-94288	192	27-13709	REC27-13709	217	27-860233	REC27-863724Q	251
25-97387	REC25-97387	215-277	27-14250	REC27-14250	215	27-863724	REC27-863724Q	251
2566111	REC378444	157	27-18272	REC27-18272	224-251	27-863724Q	REC27-863724Q	227-237-239-251
26-12224	REC26-12224	216-263-267-275	27-33179Q02	REC27-33179Q02	180	27-8637251	REC27-8637251	227-237-239-251
26-12709	REC26-12709	216	27-33395	FEL17420	233-235-237-253	27-863726	REC27-863726	251
26-127091	REC26-12709	277	27-33395	REC27-33395	233-235-237-249-253	27-863726	REC27-863726	227-237-239-251
26-14077	REC26-76868	216-275	27-33956	REC27-33956	187	27-864547A02	REC27-864547A02	252
26-14240	REC26-14240	216-217	27-34213	REC27-34213	124-125	27-864547A02	REC270	233-251
26-14756	REC26-14756	213-214-216	27-34486-3	REC27-344861	174	27-864549A02	REC270	251
26-16709A2	REC26-16709A2	276-277	27-34897	REC27-34897	187	27-864549A02	RM27-864549A02	252
26-16977	REC26-16977	216-261-265	27-34898	REC27-34898	125	27-864550A02	REC270	251
26-20070	REC908855	216	27-35898T	REC27-35898T	218	27-864850A02	REC27-864850A02	252
26-24590	REC26-24590	216	27-39915	REC27-39915	218-251	27-871051	REC27-863726	251
26-26226	REC310599	216	27-39917	REC27-39917	218-250	27-89656-1	REC27-89656-1	181
26-30913	REC26-30913	216	27-39923	BAMC47-27-39923	218-250	27-896561	REC27-89656-1	224
26-31249	REC26-24590	216	27-40431	REC27-40431	241	27-898101475	REC27-8M0094247	143
26-32511	REC26-32511	216-259	27-41609	REC27-41609	137-140	27-8M2021920	REC27-33918	181
26-32511A1	REC26-32511A1	258-259	27-41812	REC27-41812Q	181	27-94914	REC27-94914	192
26-32911	REC26-32911	216	27-418122	REC27-418122	181	27-94996Q2	REC27-94996Q2	269-271-295-299
26-33144A2	REC26-33144A2	261-265	27-41812Q	REC27-41812Q	181	27-96429	REC27-96429	221-253
26-33467	REC26-33467	216	27-41813	REC27-863724Q	251	27-97542	REC27-856705	251
26-34217	REC26-34217	216	27-42457	REC27-42457	125	27-97542	REC27-856705	251
26-36556	REC26-36556	279-281	27-42631-1	REC27-426311	265	27-988231	REC27-988231	291-296
26-36557	REC26-36557	259	27-430331	REC27-430331	273	27-995061	REC27-995061	291
26-38970	REC26-38970	261-265	27-46401	FEL17319	225-252	27-99757	REC27-99757	227-229-230-252
26-416071	REC26-8M2005029	291-296	27-46820	REC27-46820	239-240-253	27-99771	REC27-99771Q02	251
26-41953	REC26-419533	216	27-47510Q	REC27-47510Q	180	27-99772	REC27-99772Q02	251
26-43035	REC26-43035	216	27-47590-1	REC27-475901	181	27-99777Q02	REC27-99777Q02	219-221-222-225-235-241-251
26-43036	REC26-43036	216	27-47644-1	REC27-47644-1	290-291			
26-43993	REC26-43993	216-277	27-48042	REC27-48042	240-251			
26-45577 1	REC26-455771	216-263-267-273-279-281-283	27-480431	REC27-480431	219-225-235-240-250	27-99960	REC27-99960	251
26-45587	REC26-45587	216	27-48399	REC27-48399	137-141	28-30281	REC28-30281	263-267
26-54925	REC26-54925	291	27-48818Q01	REC27-48818Q01	181	28-8M0032833	REC28-8M0032833	273
26-55682	REC26-55682	216-291	27-49110	REC27-49110	187	28-8M0032834	REC8M0032834	261
26-56397	REC26-56397	216	27-49953	REC27-49953	215	30-72961	REC30-72961	192
26-56788	REC26-56788	216	27-524572	REC27-524572	137-139-140-141-142	30-879194A01	REC30-879194A01	291
26-62818	REC26-62818	216	27-52546	REC27-52546	218-252	30-879194A01	REC30-879194A01	296
26-64818Q4	REC27-64818Q4	259	27-53045Q01	REC27-53045Q01	181	30-88957T	REC30-88957T	263-267
26-66302	REC26-66302	216-269-271-273	27-53354	REC27-53354	219-252	30-88957T1	REC30-88957T1	275
26-67388	REC26-67388	216-217	27-54014Q1	REC27-54014Q1	108-299	30-98475T1	REC30-98475T1	179
26-69188	REC26-69188	216	27-5450	REC27-54506	181	300-8M0044991	REC300-8M0044991	161
26-69189	REC26-69189	216	27-54529	REC27-54529	215	31-15842	REC31-15842	275
26-70081	REC26-70081	216	27-55810 1	REC27-558101	259	31-15844	REC31-15844	275
26-72785	REC26-72785	192-216	27-56108	REC27-56108	215	31-30894A1	REC31-30894A1	275
26-75413	REC26-75624	216	27-56880	REC27-56880	187	31-30894A5	RM31-30894A5	271
26-75624	REC26-75624	216-217	27-60208	REC27-60208Q	181	31-30895T	REC31-30895T	263-267-275
26-75980	FEL17740	216-217	27-60715	REC27-60715	137	31-30956T	REC387247	263-267-275
26-75988	REC26-75988	216	27-64692	REC27-64692	137-219-221	31-32573A1	REC31-32573A1	259-271
26-76868	REC26-76868	216-263-267-279-281	27-64718A1	REC27-64718A1	259	31-32575T1	REC31-32575T1	259-269-271
26-76868A04	REC26-76868A04	279-281-283	27-64818Q4	REC27-64818Q4	295-299	31-33138A1	REC31-33138A1	273
26-79831	REC26-79831	216	27-65577	REC27-65577	137	31-35928T1	REC31-35928T1	263-267-275
26-804507	REC26-8M0150312	216	27-684547A02	REC270	229	31-35988A12	REC31-35988A12	259-269
			27-68714	REC27-68714A6	201-203-215	31-35990A1	REC31-35990A1	259-269-271
						31-36387A1	REC31-36387A1	265-273

OEM	REF	PAG.	OEM	REF	PAG.	OEM	REF	PAG.
31-42647A1	REC387817	267-275	32-864959	REC32-864959	306-307-309	35-808275	REC35-808275	116
31-53079A1	REC31-53079A1	261	32-864960	REC32-864960	306-307-309	35-809097	LENS3213	111
31-54042T	REC31-54042T	279-281	32-87117	REC32-871171	200	35-809097	RACS3213	111
31-61100A1	REC31-61100A1	259-269	32-871171	REC32-871171	200	35-809099	RACS3214	111
31-66668A1	REC31-66668A1	281	32-87234	REC32-87234	309	35-815419	REC016940	121
31-66818A1	REC31-66818A1	259	32-87235	REC32-87235	309	35-816168	REC35-816168	122
31-814653	REC31-814653T	275	32-88795	REC32-88795	199	35-850481	REC500MA	119
31-815900	REC31-815900	277	32-887952	REC32-887952	199-201-202	35-850481A1	REC500MA	119
31-828437A2	REC31-828437A2	267-275	32-89653	REC32-89653	198	35-863829	RM35-863829	113
31-828439A2	REC31-828439A2	275	32-897181	REC32-897181	199-202-203	35-864572	REC864572	112
31-86748A1	REC31-86748A1	279-281-283	32-897301	REC32-897491	200-202-203	35-866171A01	REC35-866171A01	112
31-86752A1	REC31-86752A1	279-281-283	32-89749-1	REC32-897491	200-202-203	35-866340Q03	REC35-06003	104-105-106-107-114
31-86754T	REC31-86754T	279-281	32-8M0062102	REC8M0062102	198	35-866340Q03	RM35-866340Q02	114
31-86763A04	RM31-86763A04	277	32-8M0062102	REC8M0062102	296	35-866594K01	RM35-866594Q01	110
31-86763A2	REC31-86763A2	277	32-8M0062309	REC32-4172533	198	35-866594Q01	RM35-866594Q01	110
31-86771	REC31-86771	277	32-8M0062614	REC32-33220	200	35-879172104	REC35-879172104	107-116
31-87156	REC31-87156	277	32-90949T	CEF500511K	253	35-879172143	REC35-879172143	107-120
31-92366A1	REC31-92366A1	263			221-224-227-237-239-253	35-879312041	REC35-879312041	107-121
31-99328A1	REC31-66668A1	279-283	32-90949T	REC32-90949T		35-881132T	REC35-8M0138697	114
31640A4	CM31640	288	32-95858	REC32-861127	309	35-883702Q	REC35-06004	104-105-114
31640A4	CM31640A	288	32-95859	REC32-861129	309	35-883702Q	RM35-883702Q	114
31640Q4	CM31640	263-267	32-96246A4	REC32-96246A4	199-201-202	35-884380T	RAC31871	112
31640Q4	CM31640A	263-267	32-99902	REC32-864589	309	35-884380T	REC35-8M0122423	112
31640Q4	REC31640Q4	285	32-99902-1	REC32-864960	309	35-886638	LENS3227	111
31640Q4	REC31640Q4AL	285	32-99903	REC32-864588	309	35-886638	RACS3227	111
32-14358	CEF500508K	253	32-99903-1	REC32-864959	309	35-892665	REC35-892665	105-106-107-113
32-14358	REC32-14358001	253	32-99904	REC32-99904	309	35-89272048	REC35-89272048	120
32-14358001	CEF500508K	253	32-99904Q	REC32-99904	306-307-308	35-8M0020349	RAC31871	112
32-14358001	REC32-14358001	227-220-230-233-237-239-253	32193A2	REC1463-9382	162	35-8M0020349	REC35-8M0122423	112
32-14358T	CEF500508K	253	32734A3	CEF500512K	300	35-8M0046752	REC35-8M0046752	112
32-14358T	REC32-14358001	253	32734A3	REC18654A1	300	35-8M0060041	RAC31871	112
32-16012	REC32-16012	199	33-55816	REC32-55816	305	35-8M0060041	REC35-8M0122423	112
32-160211	REC32-160211	200-201-202	3302-804689	REC3302-804689	136-140-141	35-8M0066483	REC35-8M0066483	107-121
32-32461	REC32-32461	198-291-295	3302-804845	REC3302-804845002	139-140-141-171	35-8M0067337	REC35-8M0067337	107-116
32-32461A1	REC32-32461	198-108	3302-9031	REC3302-9031	138	35-8M0067597	REC6S01030	120
32-33189	REC32-33189	199-201-202-203	3302-9033	REC35-53336	113	35-8M0103963	REC35-19486	116
32-33220	REC32-33220	200	3302-9407	REC3302-9407	136-140-141	35-8M0116378	REC35-06007	114
32-3322070	REC32-33220	200	3302-9437	REC3302-804845	138	35-8M0138697	REC35-8M0138697	114
32-4172533	REC32-4172533	198-291-295	3304-9354A2	REC3304-9354A2	132	35-8M0150917	REC882687	122
32-43437	REC32-43437	198-296	3310-804624R1	REC1347-816373A4	134	35-8M2001030	RM35-8M2001030	113
32-44348	CEF500507K	253	3310-806077A2	REC3310-860070A2	135	35-8M6002131	REC35-8M6002131	107-120
32-44348	REC32-44348001	253	3310-806078A2	REC3310-860070A2	135	35-8M6002390	REC35-8M6002390	116
32-44348001	CEF500507K	253	3310-807312A1	REC3310-807312A1	133	35-93568	REC93568	113
32-44348001	REC32-44348001	221-222-227-229-230-233-237-239-253	3310-807312R02	REC3310-807312A1	133	36-97335	REC3853341	216
32-44348T	CEF500507K	253	3310-815396A2	REC3310-860070A2	135	36223A1	CEF500522K	299
32-44348T	REC32-44348001	223-253	3310-861245A1	REC3310-860070A2	135	36223A2	REC36223A2	299
32-48132	REC32-48132	201-202-203	3310-861448A1	REC3310-864943A01	134	36223A2	CEF500522K	299
32-52481	REC32-52481	198-200-201	3310-864941A01	REC3310-864942A01	134	36223A2	REC36223A2	299
32-54236	REC32-54236	259	3310-864942A01	REC3310-864942A01	135	39-74381A1	REC39-74381A1	217
32-55816	REC32-55816	309	3310-864943A01	REC3310-864943A01	134	391-5075	REC982209	168
32-58432A2	REC32-58432A2	305-309	3310-9350A2	REC3310-860070A2	135	391-5075Q1	REC982209	168
32-59841	REC32-59841	305-309	33662Q	REC33662	170	391-5088	REC89825302	169
32-59842	REC32-59842	305-309	33765T	REC33765T	168	391-5090	REC391-5090	170
32-805375	RM32-805375	199-202	33863T	MP514693	193	391-5090A1	REC391-5090Q1	170
32-806209-1	RM32-806209-1	199	34127T2	CM34127	288	391-5090Q1	REC391-5090Q1	170
32-8066351	REC32-8066351	200-201-202-203	34127T2	CM34127A	288	391-5092	REC8M6001217	170
32-8066361	REC32-8066361	200-201-202-203	34235A1	REC3423A1	170	391-5093	REC8M6001217	170
32-806856	REC32-806856	199-201-202-203	34235Q1	REC3423A1	170	391-7057	REC89825302	169
32-807407	REC32-807407	199	34235T	REC34235T	170	391-898253004	REC391-5090	170
32-807458T	CEF500532K	253	34762A1	CM34762	288	392-6316	REC392-6316	176
32-807458T	REC32-807458T	253	34762A1	CM34762A	288	392-6318	REC835702	168
32-807661	REC32-807661	199-201-202	34765A2	REC34765A2	254	392-6318T	REC835702	168
32-807697	REC32-807697	200-201-202-203	35-11004A1	REC35-8M0046752	112	392-6324	REC8M6001249	170
32-808033	REC32-808033	199	35-16595Q	REC3850559	114	392-6324A1	REC392-6324Q1	171
32-808044-1	REC32-8080441	199	35-16595T1	REC3850559	121	392-6324Q1	REC392-6324Q1	171
32-8600891	REC32-8600891	199-203	35-19485	REC127695-35150	121	392-6324T1	REC392-6324Q1	171
32-860144	RM32-860144	200-201	35-19487	REC35-19486	116	392-6325	REC8M6001219	170
32-860205	REC32-860205	199-201-203	35-49088A2	REC35-49088A2	113	392-6325A1	REC392-6325Q1	171
32-860220	REC32-860220	269-271	35-49088Q2	REC35-49088A2	113	392-6325Q1	REC392-6325Q1	171
32-860331	RM32-860331	200	35-52731	REC3850559	121	392-6325T1	REC392-6325Q1	171
32-86036	REC32-86036	305-309	35-53336	REC35-53336	113	392-6326	REC834975	169
32-86036Q	REC32-86036	309	35-53336Q	REC35-53336	113	392-6326T	REC834975	169
32-861057	RM32-861057	200	35-802886Q	REC35-06007	114	392-6330	REC392-6330	176
32-861127	REC32-861127	306-307-308-309	35-803470	REC3517857	121	392-7803A4	REC300-00879	161
32-861128	REC32-861128	306-307-308-309	35-803897Q1	REC3517857	112	392-805570A2	REC300-00879	161-174
32-862124	REC32-862124	200	35-80470Q	REC3517857	121	392-806529A1	REC1463-9382	162
32-862139	REC32-862139	200	35-805312	REC35-805312	120	392-863704T	REC3861985	161
32-864588	REC32-864588	306-308-309	35-805809	REC35-805809	121	392-881732	REC3861267	161
32-864589	REC32-864589	306-308-309	35-807256T	REC35-807256	116	392-889925	REC3861267	161
						392-898223002	REC3859078	161
						392-898253005	REC8M6001249	170
						392-8M0054588	REC8M6001219	170
						392-9086	REC3861985	175
							REC392-9086T	168



OEM	REF	PAG.	OEM	REF	PAG.	OEM	REF	PAG.
392-9086T	REC392-9086T	168	46-64141A11	REC46-64141A11	189-260-261	48-16315A46	SOL1532-143-17	316
392-9089	REC3853801	169	46-72774A11	REC46-72774A32	187	48-16315A46	SOL1552-148-16	316
392-9089Q	REC3853801	169	46-72774A32	REC46-72774A32	187	48-16316A46	SOL1531-140-19	316
392-9089T	REC3853801	169	46-72774A69	RM46-807151A8	185	48-16316A46	SOL1551-148-18	316
392-9766	REC392-9766	168	46-73823A7	REC46-72774A32	187	48-16317A46	SOL1532-140-19	316
392-9766Q1	REC392-9766	168	46-807151A12	REC46-72774A32	187	48-16317A46	SOL1552-148-18	316
392-9766T	REC392-9766	168	46-807151A14	REC46-807151A14	192	48-16318A46	SOL1531-140-21	316
392-9767	REC3853801	169	46-807151A8	RM46-807151A8	185	48-16318A46	SOL1551-148-20	316
393-3230	REC3854331	168	46-807151A9	REC46-807151A9	186	48-16319A46	SOL1532-140-21	316
393-3230	REC393-4988	168	46-862914T10	REC46-862914T10	187	48-16319A46	SOL1552-148-20	316
393-4988	REC393-4988	168	46-879194401	REC879194401	185	48-16320A46	SOL1531-140-23	316
393-4988T	REC3854331	168	46-96148A5	REC46-96148A8	190	48-16320A46	SOL1551-143-22	316
393-4988T	REC393-4988	168	46-96148A8	REC12120	189-264-265	48-16321A46	SOL1532-140-23	316
393-4988T2	REC3854331	168	46-96148A8	REC46-96148A8	190	48-16321A46	SOL1552-143-22	316
393-4988T2	REC393-4988	168	46-96148T1	REC46-96148T1	261-265	48-16322A46	SOL1531-140-25	316
393-9459Q1	REC3854331	168	46020T02	REC46020T02	259-269	48-16322A46	SOL1551-140-24	316
41141A2	REC862077A1	124	46399A1	CM46399	288	48-16543A46	SOL1552-148-19	316
414336A6	REC865380A25	155	46399A1	CM46399A	288	48-16544A46	SOL1551-148-19	316
41629A2	RM45-41629A2	279	47-43026Q02	CEF500301	188	48-16545A46	SOL1552-145-21	316
41641A8	REC41641A8	279	47-43026Q02	REC47-43026Q02	109-188-273	48-16546A46	SOL1551-145-21	316
41641A8	REC41641A8	281	47-43026Q06	REC47-43026Q06	108-190	48-16547A46	SOL1552-143-22	316
4164A9	RM4164A9	297	47-59362A4	REC47-59362A4	187-191	48-16548A46	SOL1551-143-22	316
41674T	REC41674T	296	47-59362Q01	CEF500109	188	48-16549A46	SOL1552-140-24	316
41674T	REC41674T	297	47-59362Q01	REC47-59362Q01	188-192	48-16550A46	SOL1551-140-24	316
42260A6	RM42260A6	291	47-59362Q08	REC47-59362Q08	191	48-18278A46	SOL1511-155-17	316
42419A1	REC42419A1	156	47-59362T5	REC47-59362T5	191	48-18278A46	SOL1571-155-17	316
42600A09	REC42600A09	159	47-59362T6	REC47-59362T6	191	48-18610A40	SOL1611-193-15	316
42600A1	REC42600A09	159	47-801332602	CEF500106GT	188	48-18610A40	SOL1641-193-15	316
42600A3	REC42600A09	159	47-801332602	JOH09-1028B	188	48-18610A6	SOL1611-193-15	316
42600A5	REC42600A09	159	47-801332602	REC3841697	188	48-18610A6	SOL1641-193-15	316
42724A3	REC42724A3	259	47-808145T	SHE15979	186-191	48-18611A40	SOL1612-193-15	316
42815A6	RM42815A6	295	47-809866T	CEF500161	188	48-18611A40	SOL1642-193-15	316
43-14063A1	RM43-14063A1	279-281	47-809866T	REC47-809866T	188	48-18611A6	SOL1612-193-15	316
43-18411A2	REC43-18411A2	259-269	47-816814T	CEF500177GT	188	48-18611A6	SOL1642-193-15	316
43-18411A4	REC43-18411A2	259-268-269	47-816814T	JAB17018-0001	107-188	48-18612A40	SOL1611-188-17	316
43-45814A5	REC43-45814A5	259-269	47-816814T	REC3593573	188	48-18612A40	SOL1641-188-17	316
43-55778A3	REC43-55778A3	259-269	47-831311350	CEF500161	188	48-18612A6	SOL1611-188-17	316
43-66773A3	RM43-66773A3	259	47-831311350	REC47-809866T	188	48-18612A6	SOL1641-188-17	316
43-75325A3	REC43-75325A3	259-269	47-853126	CEF500167	188	48-18613A40	SOL1612-188-17	316
43-818807	REC43-818807	174	47-853126	SHE15000K	188	48-18613A40	SOL1642-188-17	316
43-828073A1	REC43-828073A1	267-275	47-853126	SHE15000K	188	48-18613A6	SOL1612-188-17	316
43-853592A2	REC43-878617A2	275	47-862232A2	CEF500159G	188	48-18613A6	SOL1642-188-17	316
43-853640A2	REC43-853640A2	271	47-862232A2	REC47-862232A2	188	48-18614A40	SOL1611-183-19	316
43-853641A2	REC43-853641A2	271	47-879194186	CEF500114T	188	48-18614A40	SOL1641-183-19	316
43-853642A2	REC43-853642A2	271	47-879194186	JAB17937-0001-P	107-188	48-18614A6	SOL1611-183-19	316
43-853643A2	REC43-853643A2	271	47-879194186	REC17937-0001	188	48-18614A6	SOL1641-183-19	316
43-878087A2	REC43-878087A2	275	47-879312025	CEF500120T	188	48-18615A40	SOL1612-183-19	316
43-887903A1	RM43-887903A1	277	47-879312025	REC10615K	186-188	48-18615A40	SOL1642-183-19	316
43-887906A1	RM43-887906A1	277	47-879312025	SHE10615K	107-188	48-18615A6	SOL1641-183-19	316
43-887909A1	RM43-887909A1	277	47-896332063	CEF500155	188	48-18615A6	SOL1642-183-19	316
43557A1	REC805759Q01	168	47-896332063	JAB11979-0001	107-188	48-18616A40	SOL1611-178-21	316
43881A17	RM43881A17	296	47-896332063	REC11979-0001	188	48-18616A40	SOL1641-178-21	316
43994A2	CM43994	288	47-89984Q5	REC47-89984Q5	190	48-18616A6	SOL1611-178-21	316
43994A2	CM821631	288	47-89984Q5	RECMC00004	190	48-18616A6	SOL1641-178-21	316
43994A2	CM821631A	288	47-89984T4	CEF500313G	188	48-18617A40	SOL1612-178-21	316
44-41630T	RM44-41630T	279-281	47-89984T4	REC47-89984T4	188-261-265	48-18617A40	SOL1642-178-21	316
44-8146061	REC44-8146061	267	47-8M0104229	CEF500159G	188	48-18617A6	SOL1612-178-21	316
44-824110	REC44-824110	263-267-275	47-8M0104229	REC47-862232A2	188	48-18617A6	SOL1642-178-21	316
44-850308	REC44-850308	275	47441A1	REC47441A1	180	48-18618A40	SOL1641-175-23	316
44-850308	RM44-41630T	279	47442A1	REC8M0061068	180	48-18618A6	SOL1641-175-23	316
44-865322T	RM44-865322T	283	47587A2	BAMC29-47587	177	48-18619A40	SOL1642-175-23	316
44181A1	RM44181A1	217	47638A1	BA1-47638	218-250	48-18619A6	SOL1642-175-23	316
44182A1	FEDV-1984	217	47735A1	BAMC1-47735	244	48-18620A40	SOL1641-175-23	316
44182A1	RM44182A1	217	47735A17	BAMC1-47735	240-244	48-18620A6	SOL1641-173-25	316
44266T	RM807130A4	250	47736A17	BAMC1-47736	240-244	48-18621A40	SOL1642-173-25	316
44266T1	RM807130A4	250	47737A1	BAMC1-47737	240-244	48-18621A6	SOL1642-173-25	316
44354A3	MAR988	245	47737A10	BAMC1-47737	244	48-19838A46	SOL1511-158-15	316
44354A3	MAR988	245	47738A1	BAMC1-47738	240-244	48-19841A46	SOL1512-158-15	316
45-41629A2	RM45-41629A2	281	47738A10	BAMC1-47738	244	48-78114A45	SOL1511-160-13	316
45-41939F1	REC45-41939F1	261	47877A4	BAMC20-76668	245	48-78114A45	SOL1531-156-13	316
45-42634	REC45-42634	265	48-13700A46	SOL1511-153-19	316	48-78116A4	SOL1513-148-15	316
45-55796	REC45-55796	259	48-13700A46	SOL1571-153-19	316	48-78116A4	SOL1531-145-15	316
45-55796-1	REC45-557961	269	48-13701A46	SOL1512-153-19	316	48-78126A45	SOL1511-142-23	316
45-557961	REC45-557961	271	48-13701A46	SOL1572-153-19	316	48-78126A45	SOL1531-140-25	316
45-812773	RM45-812773T	277	48-13702A46	SOL1511-153-21	316	48-826072A46	SOL1511-160-13	316
45-816919	REC45-816919	273	48-13702A46	SOL1571-150-21	316	48-831850A45	SOL1513-145-17	316
45-853648	REC45-853648	273	48-13703A46	SOL1512-153-21	316	48-832828A45	SOL1511-150-15	316
45518A3	REC45518A3	295-302	48-13703A46	SOL1572-150-21	316	48-832828A45	SOL1513-145-17	316
45518T1	REC45518T1	295-302	48-13704A46	SOL1511-153-23	316	48-832828A45	SOL1531-143-17	316
45589A3	REC45589A3	295-302	48-13704A46	SOL1571-148-23	316	48-832830A45	SOL1511-148-17	316
46-44292Q03	REC46-44292Q03	189-265	48-13705A46	SOL1572-148-23	316	48-832830A45	SOL1513-143-19	316
46-48748A1	REC46-48748T1	189	48-13706A46	SOL1571-145-25	316	48-832830A45	SOL1531-140-19	316
46-48748T1	REC46-48748T1	189	48-13707A46	SOL1572-145-25	316	48-832832A45	SOL1511-145-19	316
46-59112A2	REC46-72774A32	187	48-16312A46	SOL1531-145-15	316	48-832832A45	SOL1513-140-21	316
46-60367A1	REC46-96148A8	190	48-16314A46	SOL1531-143-17	316	48-832832A45	SOL1531-140-21	316
46-63450A2	REC46-72774A32	187	48-16314A46	SOL1551-148-16	316	48-832834A45	SOL1511-143-21	316

OEM	REF	PAG.	OEM	REF	PAG.	OEM	REF	PAG.
48-832834A45	SOL1513-140-23	316	54-12078	RM54-12078	293-298	6-6311002NZ	TRANSONBRAVO	298
48-832834A45	SOL1531-140-23	316	54-38863	REC54-38863	291-296-300			219-221-
48-834851A45	SOL1514-145-17	316	54-815504256	GS38320	221-222-227-237-239	60252A2	REC60252A2	225-235-241-250
48-834852A45	SOL1513-143-19	316	54-815504272	GS38320	233	60372A1	BAMC29-60372	180
48-834853A45	SOL1514-143-19	316	54-815504320	REC54-815504320	108-291-296-300	60372A2	BAMC29-60372	180
48-834854A45	SOL1513-140-21	316	54-815504372	GS38320	221	60426A1	HOT20971	246
48-834855A45	SOL1514-140-21	316	54-815504372	GS38322	221	60932A1	CEF500516K	299
48-90159A46	SOL1512-155-17	316	54-815504372	GS38322	221-227-230-237-239	60932A1	REC60932A4	299
48-90159A46	SOL1572-155-17	316	54-815504412	REC54-815504412	295	60932A4	CEF500516K	299
48101A1	BAMC20-72963	246	54-815504456	GS38310	229-233	60932A4	REC60932A4	295-299
48752T	REC48752T	261-265	54-815504456	GS38320	229	61811A3	BAMC20-61811A4	248
5-5000147CP	REC1623-8951A33	256	54-86049	REC54-86049	295-297-300	61811A4	BAMC20-61811A4	248
5-5000162CP	REC1623-8951A33	256	54-896332164	RM21325765	143	61851A3	BAMC20-61851A3	248
5-5000181CP	REC1623-8951A33	256	55131A5	REC55131A5	178	62092T	REC62092T	124
5-5000194CP	REC1623-8951A33	256	55538A2	BAMC-20-55538	218-245	623-815822A55	REC1623-815822A55	257
5-5010147CP	REC1623-8951A43	256	55989A9	CM55989	288	62898A1	BAMC29-62898	180
5-5010162CP	REC1623-8951A43	256	55989A9	CM55989A	288	63122A10	BAMC-1-63122	218-242
5-5010181CP	REC1623-8951A43	256	55989Q9	CM55989	288-291	63122A13	BAMC-1-63122	212-242
5-5010194CP	REC1623-8951A43	256	55989Q9	CM55989A	288	63122A14	BAMC-1-63122	218-242
5-5111200TP	REC1623-815822A47	257	55989Q9	REC55989Q9	109-285-291	63588A1	BAMC29-63588	178
5-5111300TP	REC1623-815822A47	257	55989Q9	REC55989Q9AL	108-285	65057A1	REC65057T1	157
5-5111400TP	REC1623-815822A47	257	55989Q9	REC55989Q9M	285	65057T1	REC65057T1	157
5-5111500TP	REC1623-815822A47	257	57-13457Q	REC57-13457Q	105-195-196-198	65533A1	REC65533A1	291
5-5121200TP	REC1623-815822A53	257	57-13458Q	REC966931	196-198	65603A12	HOT20962	241-244
5-5121300TP	REC1589-865440H52	255	57-32850	REC3852106	198	65603A3	HOT20962	244
5-5121300TP	REC1623-815822A53	257	57-34359	REC57-34359	198	65604A12	HOT20958	241-244
5-5121300TP	REC1656-8866A63	255	57-36356	REC57-36356	198	65604A4	HOT20958	244
5-5121400TP	REC1623-815822A53	257	57-37619T,Q	REC57-34359	198	66081A2	REC66081A2	259-269-271
5-5121500TP	REC1623-815822A53	257	57-45856	REC3858462	198	66688A1	REC31-66688A1	279
5-5231100NP	REC1589-865440H50	255	57-48120Q1	REC829207	198	68521A3	REC17177A1	175
5-5231100NP	REC1656-8866A55	255	57-48122Q1	REC57-48122Q	196-198	68521A4	REC17177A1	175
5-5231100TP	REC1589-865440H50	255	57-49043A1	REC57-49043A1	198	69354A2	REC69354A2	217-303
5-5231100TP	REC1656-8866A63	255	57-49211	REC57-64416	198	70125A02	REC70125A02	142
5-5231200NP	REC1589-865440H51	255	57-49213A1	REC3858462	198	70125A1	REC70125A02	142
5-5231200NP	REC1656-8866A55	255	57-52692	REC57-52692	198	70981A3	CEF500523	253
5-5231200TP	REC1589-865440H51	255	57-64032Q1	REC57-49043A1	198		REC70981A3	221-224-221-235-237-239-253
5-5231300NP	REC1589-865440H50	255	57-64416	REC57-64416	198	71464A01	REC71464A01	142
5-5231300NP	REC1656-8866A55	255	57-65607T	REC57-65607Q	198	72608T	MP425149	254
5-5441100TP	REC1589-865440H50	255	57-69143Q	REC3852106	198	72963A1	BAMC20-72963	246
5-5441100TP	REC1656-8M0046733	255	57-74271Q	REC966903	195-196-198	72963A9	BAMC20-72963	240-246
5-5441200TP	REC1589-865440H51	255	57-77274	REC966900	195-198	72964A1	BAMC20-76668	245
5-5441200TP	REC1656-8M0046733	255	57-78200Q1	REC57-78200Q1	196-198			
5-5441300TP	REC1589-865440H51	255	57-807755Q04	REC57-807755Q04	197	73813A1	HGE4870	218-219-221-225-235-240-241-250
5-5441300TP	REC1656-8M0046735	255	57-807755Q05	REC57-807755Q05	197			
5-5441400TP	REC1589-865440H50	255	57-816295Q	REC57-816295Q	104-195-196-198	73873A1	REC73873A1	292
5-5441400TP	REC1656-8M0046738	255	57-817113	REC57-817113	197	74639Q02	CEF500513K	299
5-5441500TP	REC1589-865440H52	255	57-861049Q	REC57-861049Q	197	74639Q02	REC74639Q02	291-296-299
5-5441500TP	REC1656-8M0046738	255	57-861757Q	REC57-861757Q	197	74905A3	REC17177A1	175
5-5441600TP	REC1589-865440H51	255	57-861758Q	REC57-861758Q	197	75832T	REC75832T	259-269
5-5441600TP	REC1656-8M0046738	255	57-861759Q	REC57-861759Q	197	75832T1	REC3850812	259-269
5-5441700TP	REC1589-865440H52	255	57-865615005	REC57-865615Q05	197	76214-4	CM762144	288
5-5441700TP	REC1656-8M0046682	255	57-865615007	REC57-865615Q07	197	76214-4	CM762144A	288
50-12782	REC3854190	151	57-865615010	REC57-865615Q10	197	76214-5	TEN00820	286
50-47454	REC50-97499A2	152	57-865615Q01	REC57-865615Q01	197	76214A2	CM762144	281
50-56886	REC3854190	151	57-865615Q02	REC57-865615Q02	197	76214A2	CM762144A	281
50-65785A1	REC50-97499A2	152	57-865615Q03	REC57-865615Q03	104-105-197	76214A2	CM762145	288
50-69865A1	REC3854190	151	57-865615Q04	REC57-865615Q04	104-105-197	76214A2	CM762145A	288
50-72550A2	REC50-97499A2	152	57-865615Q06	REC57-865615Q06	197	76214Q5	CM762144	283
50-79604A3	REC50-97499A2	152	57-865615Q07	REC57-865615Q07	197	76214Q5	CM762144A	283
50-805991	REC3916854	152	57-865615Q08	REC57-865615Q08	104-105-197	76214Q5	CM762145	275-270-288
50-806963A2	REC50-806965A4	152	57-879172120	REC57-879172120	107-198	76214Q5	CM762145A	275-288
50-806965A2	REC50-8M0090697	152	57-879194425	REC57-879194425	198	76214Q5	CM76214Q5	288
50-806965A4	REC50-806965A4	152	57-882531	REC57-882531	198	76214Q5	REC76214Q5	284-285
50-806965A4	REC50-8M0090697	152	57-882531T	REC57-882531	198	76214Q5	REC76214Q5AL	109-284-285
50-808011A05	REC50-808011A05	151	57-898101579	REC57-898101579	107-198	76325A2	REC76325A2	221-225-245-251
50-80811A4	REC50-808011A05	151	57-898101624	REC57-879194425	198	76351A04	HGE6351	241
50-812429A2	REC50-8M0090697	152	57-8M0074767	REC57-8M0074767	197	76351A04	HOT20971	219-225-235-241-246
50-863007A1	REC50-806965A4	152	57-8M0088876	REC57-8M0088876	197	76351A2	HOT20971	246
50-863007A1	REC50-863007A1	151	57-8M0093495	REC57-8M0093495	198	76514Q5	HOT20971	246
50-864340A2	REC3885317	151	57-8M0097728	REC57-8M0097728	197	76668A1	CM762145A	279
50-864340A2	REC50-99418A2	151	57-91035Q1	REC57-91035Q1	195-196-198	76668A1	BAMC20-76668	245
50-88671A1	REC50-808011A05	151	57-93658Q	REC3858462	198	76668A3	BAMC20-76668	240-245
50-8M0090697	REC50-8M0090697	152	58217Q	REC58217	169	76771A2	HOT20978	219-235-241
50-8M0095471	REC50-8M0095471	151	58759A1	BAMC-1-58759	243	76771A2	REC76771A2	245
50-99418A2	REC50-99418A2	151	58759A10	BAMC-1-58759	243	76771A3	REC76771A2	245
52-853594T	REC52-853594T	263-267-275	58759A13	BAMC-1-58759	243	76788A1	BAMC20-72963	246
52-865344A01	RM52-865344A01	277	58759A14	BAMC-1-58759	225-243	76850A2	REC76850A2	304
53-23720	REC53-23720	192	59078Q3	REC59078Q3	181	77234A2	HOT20950	244
53-29641	REC53-29641	265-273	59498A1	BAMC29-59498	180	77234A7	HOT20950	235-244
53-805272	REC53-805272	308	59501A1	REC59501A1	192	78403A1	REC78403A2	153
53-815949	REC53-815949	108-307	59826A3	REC59826A3	303	78403A2	REC69729	153
53-87843	RM53-87843	185-295-297	59830A7	REC59830A7	259-269-271	78403A32	REC78403A2	153
53-88242	REC53-88242	279-281-283	6-6010000CP	TRANSONALPHAI	291	78458A1	CEF500520K	300
53114A1	CEF500524	253	6-6111002LP	TRANSONALPHA2G	291	78458A1	REC78458A1	297-300
53114A1	REC53114A1	219-225-253	6-6211002NZ	TRANSONBRAVO	298	78984A08	REC78984A08	177



OEM	REF	PAG.	OEM	REF	PAG.	OEM	REF	PAG.
78984A1	REC78984A08	177	807166A3	REC807166A3	253	821631Q1	CM821631A	291
78985A1	BAMC29-78985	178	807252Q3	REC807252Q3	182	821631Q1	REC821631Q1	284-285
802630T	REC802630T01	129	807252Q4	REC807252Q4	182	821631Q1	REC821631Q1AL	108-109-284-285
802630T01	REC802630T01	129	807252Q5	REC807252Q5	182	822777Q1	CM46399	288
802632T	REC802632T	130	807252T1	REC8M0089715	182	822777Q1	CM46399A	288
802632T	REC9-33304	131-150	807252T2	REC8M0091470	182	823426A1	REC823426A1	139-140-141-142
804483T	REC3854548	168	807252T4	REC807252Q4	182	823427A1	REC823427A1	137
804626R02	REC804626R02	132	807289A1	REC425062	254	824324T	MP425024	254
805016A1	REC805016A1	142	807371T1	RM807371T1	184	824330T	MP425036	254
805025A2	REC3858261	127	807476A6	MAR3320PAR	248	827682T	REC827682T	126
805025A2	REC861155A6	127	807652T	REC807652T	154	828151A1	REC3854138	158
805101T	REC805101T	283	807653T	REC807653T	154	828692A1	REC828692A1	269-271
805182A1	RM805182A1	283	807729T	MP154516	193	828830A2	REC828830A2	275
805185A3	REC805185A3	176	807729T	REC8M0153706	193	834832T2	REC8M0064021	154
805185A36	REC805185A36	174-176	807731T	REC861579	186	84-813720A10	REC15-801	167
805185A37	REC805185A37	174	807757T	REC807757T	193	84-813720A11	REC15-601	167
805217A1	REC3850396	144	807914A1	MAR988	245	84-813720A13	REC15-405	167
805218T	REC3850397	148	807914A1	MAR988	245	84-813720A2	REC15-804	167
805222A1	REC805222A1	173-176	807929A1	REC807929A1	273	84-813720A3	REC15-804	167
805223T	REC805223T	148	807952A1	REC807952A1	129-149-150	84-813720A4	REC15-804	167
805224A1	REC3855194	145-149-150	807964A1	REC807964A1	173-176	84-813720A5	REC15-804	167
805225A1	REC9-33303	131-149-150	807988A03	MAR988	227-230-237-239-245	84-813720A5	REC15-401	167
805226A1	REC8M0125617	144	807988A03	MAR988	227-230-237-239-245	84-813720A7	REC15-402	167
805227A1	REC805227A1	130-150	807988A03	MAR988	239-247	84-813720A8	REC15-604	167
805298A1	REC805298A1	142	807988A03	SED3092600	247	84-813720A8	MAG15-602	167
805320A03	REC805320A03	146-293-298	807988A03	SED3095500	247	84-813720A9	REC15-801	167
805370A1	RM45-41629A2	283	807988A2	MAR988	245	84-816608A1	REC15-815	167-175-176
805447T	REC805884T	153	807988A2	MAR988	245-251	84-816761A15	MAG15-803	167
805536A2	REC805536A2	259-269-271	807988A3	SED3092600	227	84-816761A15	REC15-804	167
805544T	REC8M0077616	145	808483T3	REC3854548	168	84-816761A2	MAG15-803	167
805602A1	SED3092000	247	808504T1	REC65L-13915-00	113	84-816761A2	REC15-804	167
805602A2	SED3093300	247	809463A1	REC3859054	157	84-816761A4	REC15-804	167
805629A1	REC805629A1	221-250	81-64851	REC64851	170	84-816761Q13	REC15-405	173
805656A2	REC3858261	127	811536T	REC811536T	136	84-816761Q16	REC15-601	173-174-176
805656A2	REC861155A6	127	811575T	MP425113	254	84-816761Q17	REC15-804	173-174
805656A5	REC3858261	127	811637T	REC3854003	162	84-816761Q7	REC15-604	167
805656A5	REC861155A6	127	811639T	REC3854001	145-162-173	84-816781A15	MAG15-803	167
805656A6	REC3858261	127	812454A1	REC862048A1	124	84-816781A15	REC15-804	167
805656A6	REC861155A6	127	812454A3	REC862048A1	124	84-816781A15	REC15-804	167
805759A1	REC805759Q01	168	814263A1	GS38105	303	84-817376T01	REC84-817376T01	173
805759A2	REC805759Q01	168	814281A7	REC8M0052939	292	84-818781A4	REC15-804	167
805759A5	REC805759Q01	168	814604A1	REC814604T1	275	84-863656A1	REC15-813	167-175
805759Q01	REC805759Q01	168-174	814606 1	REC44-8146061	275	84-863656A2	REC15-606	175
805759T1	REC805759Q01	168	814819A2	REC814819A2	259-269	842725A3	REC8M0073435	125
805759T2	REC805759Q01	168	814819A3	REC59830A7	277	850484T	REC3854331	168
805884T	REC805884T	153	814819A7	REC814819A7	271	850484T2	REC3854332	168
806031A2	RM806031A2	295	815303T	REC815303T	297	8507522+10-31700	REC8507522	292
806034A2	RM806034A2	293-298	815407A2	REC815407A2	168	851956A1	REC853998A1	131
806105Q1	CM806105	267-275	815407Q02	REC815407A2	168-174	852956A1	REC38589A1	130-149
806105Q1	CM806105A	267-275	815471T1	REC815471T1	300	853678T	REC853678T	144
806105Q1	REC806105Q1	284-285	815919A1	REC815919A1	273	853998A1	REC853998A1	131
806105Q1	REC806105Q1AL	109-284-285	815935A7	REC815935A7	307	853998T	REC853998A1	131
806188A1	CM806188	288	815954A7	REC815954A7	307	85785A2	REC805298A1	142
806188A1	CM806188A	288	816148A1	REC17177A1	175	85785T	REC805298A1	142
806188A1	CM806189	288-307	816219A5	HOT20937	242	859210T	REC881879T11	147
806189Q1	CM806189A	288-307	816431A1	CEF500515K	299	859604A1	REC881879T11	147
806189Q1	REC806189Q1	284-285	816431A1	REC816431A1	295-299	86-865202T	REC86-865202T	158
806189Q1	REC806189Q1AL	109-284-285	816597A1	REC816597A1	273	860235A03	REC860235A03	222-243-252
806190A1	CM806190	308	816629Q	REC90508-ZW1-003	263	HOT20956	HOT20956	221
806190A1	CM806190A	308	817119A1	REC3860769	153	MAR246	MAR246	244
806190Q1	CM806190	288	817119A4	REC3860769	153	MAR246	MAR246	237-244
806190Q1	CM806190A	288	817275Q05	REC78403A2	153	MAR246	MAR246	244
806190Q1	REC806190Q1	284-285	817377T	RM817275A1	273	860256A4	REC8M0061381	178
806190Q1	REC806190Q1AL	284-285	817378T	REC817275A1	109-191	860349A1	REC860349A1	129-150
806191T	REC806191T	307-308	818349T1	REC817275Q05	109-191	861006A1	REC8M0061381	178
806193A20	RM806193A48	185	818383T	REC817377	176	861126A1	REC861126A1	129-149-150
806193A38	RM806193A48	185	818763A10	REC817378T	161	861155A2	REC861155A3	127
806193A48	RM806193A48	185	821509T01	REC818349T1	263-267-275	861155A3	REC861155A3	127
806235A04	HOT20956	242	821629Q1	REC861677T	124	861155A5	REC3858261	127
806490T	REC806490T	148	821629Q1	REC818763A10	263-267-275	861155A5	REC861155A6	127
806612T	REC806612T	145	821629Q1	REC882751A04	158	861155A6	REC3858261	127
806673T	REC806673T1	161	821629Q1	CM821629	269-271-288	861156A03	REC861156A03	129
806673T1	REC806673T1	161	821629Q1	CM821629A	269-271-288	861156A04	REC861156A04	129
806867A12	REC860235A03	243	821629Q1	REC821629Q1	284-285	861249A1	REC861249A1	144
806867A3	REC860235A03	243	821629Q1	REC821629Q1AL	284-285	861260T	REC9-33302	131
806867A8	HOT20956	242	821630A1/Q1	CM821630	288	861493A07	BAMC29-47587	177
807078A6	MAR078	244	821630A1/Q1	CM821630A	288	861493A07	BAMC29-60372	180
807078T09	MAR078	244	821630Q1	CM821630	277	861493A3	BAMC29-47587	177
807078T10	MAR078	239-244	821630Q1	CM821630A	277			
		227-229-233-237-239-250	821630Q1	REC821630Q1AL	284-285			
			821631A1	CM43994	288			
			821631A1	CM821631	288			
			821631A1	CM821631A	288			
			821631Q	CM821631	296			
			821631Q	CM821631A	296			
			821631Q1	CM821631	291			

OEM	REF	PAG.	OEM	REF	PAG.	OEM	REF	PAG.
861523A9	REC861523A9	303	87-808009A2	REC87-808009A2	292	888761Q03	RECKITMBRAVO23AL	109-281-284-286
861676A1	REC8M0073435	125	87-808009A3	RM8M0052936	292	888761Q03	RECKITMBRAVO23M	284-286
861676T09	REC8M0073435	125	87-814281A5	REC87-814281A5	292	888761Q03	RECKITMBRAVO23ZN	284-286
861677T	REC861677T	124	87-815425T	REC8M0068784	147	888761Q04	RECKITMBRAVO3AL	109-283-284-286
862030T	REC862030T01	154	87-858679T2	REC87-858679T2	160	888761Q04	RECKITMBRAVO3M	284-286
862030T01	REC862030T01	154	87-859032T02	REC87-859032T02	160	888761Q04	RECKITMBRAVO3M	284-286
862031T	REC862031T1	153	87-864252	REC87-864252	147	888761Q04	RECKITMBRAVO3ZN	284-286
862031T1	REC862031T1	153	87-864252A01	REC87-864252A01	147	889514A01	REC8M0052939	292
862048A1	REC862048A1	124	87-892150Q02	REC87-892150Q02	174	89-18080	REC3853869	157
862077A1	REC862077A1	124	87-8M0052935	REC87-808009A2	292	89-68258A4	REC852565	157
862132T	REC862132T	277	87-8M0052936	RM8M0052936	292	89-805188A1	REC89-818999A2	157
86234A3	REC86234A4	124	87-91941A8	REC87-91941A8	160	89-818864	REC89-96158T	157
86234A4	REC86234A4	124	87114A19	MAR246	244	89-818864T	REC89-96158T	157
862351T	REC862351T	187	87290A26	REC87290A23	177	89-818997A1	REC89-818997A1	157
86246A1	REC86246T	124	87290A4	REC87290A4	178	89-818997T1	REC89-818997A1	157
86246T	REC86246T	124	87399A2	REC87399A2	306	89-818999A1	REC89-818999A2	157
86247A2	REC86247T	124	87399A2	REC87399A2	308	89-818999A2	REC89-818999A2	157
86247T	REC86247T	124	87399A3	REC87399A3	307	89-853654A1	REC3853869	157
862548A1	REC42419A1	156	87581T	REC195141	176	89-853654A1	REC852565	157
863077T	REC863077T	154	879150A87	REC21622232	175-176	89-91975	REC89-96054T	157
86307AR01	REC863077T	154	879194A01 & A02	REC30-879194A01	296	89-96054	REC89-96054T	157
863444T1	RM863444T1	179	879194T46	REC879194T46	302	89-96054T	REC89-96054T	157
863457A2	RM863457A2	178	88-11178A01	BS2142	158	89-96158	REC89-96158T	157
863631T1	RM863631T1	179	88-212619	BS5296	159	89-96158T	REC89-96158T	157
863786A1	REC22-863786A1	234	88-79023A91	RM88-79023A91	158	89-99253	REC3853869	157
863802T2	REC863802T2	179	88-79023A94	BS5140	159	89011A8	MAR078	244
864148A01	RM21325765	143	88-79023T10	REC88-79023T10	158	891736T	REC891736T	156
864244A2	REC864244A2	277	88-832969T05	AM603905	159	89690T	REC89690T	184
864281A01	REC864281A2	270	88-832969T10	AM603910	159	898253T22	REC898253T22	169-175
864281A2	REC864281A2	269-271	88-832969T15	AM603915	159	898253T23	REC898253T23	169-175
864282T	REC864282T	271	88-832969T20	AM603920	159	898253T24	REC14639382	162
864297T01	REC864297T01	146	88-832969T30	AM603930	159	898253T27	REC3854002	161-173
864308T01	MAR735	243	88-8M0129528	BS5185	159	8M0020941	REC17-8M0084681	263-267-275
864309T01	MAR309	245	88-8M0129530	BS5187	159	8M0029482	REC300-8M0044991	161
864309T02	MAR309	229-233-245-251	88-8M0129531	BS5189	159	8M0030022	REC8M0082988	146
864309T02	SED3095400	229-233-247	88-8M0129533	BS5175	159	8M0032176	REC876037	158
864363A1	RM864363A1	292	88-8M0129534	BS5177	159	8M0032834	REC8M0032834	265
864364A1	RM864364A1	292	88-8M0129535	BS5181	159	8M0042641	REC8M0042641	265
864591T02	MAR591	229-233-245-251	88-8M0129560	BS5182	159	8M0047215	REC8M0047215	128
864591T02	SED3095500	229-233	88-8M0130941	BS5183	159	8M0052939	REC8M0052939	292
864612T01	MAR612	229-243-248-249-252	88-8M2011907	BS2138	158	8M0054588	REC3861985	161
864625T	REC864625T	194	88-93582	BS2143	158	8M0054726	REC8M0054726	144-150
864650A05	REC8M0047215	128	881070T	REC8M0125617	144	8M0056956	CEF500167	188
864650A13	REC8M0047215	128	88183A12	REC865380A13	155	8M0056956	REC15000K	188
86481A2	REC864281A2	271	88183A12	REC865380A25	155	8M0056956	SHE15000K	188
864856A1	REC3850396	144	881879A6	REC881879T11	147	8M0057679	REC8M0133370	129
864908A1	BAMC-20-864908A1	229-233-249	881879T11	REC881879T11	147	8M0057686	REC8M6002428	130
864929A3	HGE4929	229-233	88243A3	REC88243A3	279	8M0057697	REC876037	158
864929A3	MAR929	248	88243A3	REC88243A3	283	8M0058164	REC8M0058164	125
865049T01	MAR735	243	882751A04	REC882751A04	158	8M0058389	REC22-67892A05	263-267-275-277-279
865328A01	RM865328A01	293	882751A1	REC3854138	158	8M0061381	REC8M0061381	178
865329A02	REC865329A02	292-304	882751A2	REC3854138	158	8M0062084	REC3854311	169
865380A13	REC862548A1	156	883166A2	REC883166A2	156	8M0062406	CEF500509K	299
865380A13	REC865380A13	155	884794A02	REC21622232	176	8M0062406	REC86840A05	299
865380A25	REC865380A13	155	884794A1	REC21622232	176	8M0062440	RM8M0062440	298
865425A03	RM865425A03	277	8866A64	RM1656-8866A17	279	8M0062568	RM43881A14	291
865436A02	REC865436A02	292-300	88751A02	REC40005334	175	8M0062770	REC8M0062770	126
865436A02	RM19543A10	292-300	88751A03	REC40005334	175	8M0062770	REC8M0062770	128
865437A02	REC865437A02	292-300	888751A1	REC40005334	175	8M0062771	REC8M0103289	127-128
865491A01	REC864281A2	271	888756Q02	TENKITALPHAONE/1	263-267-287	8M0066646	REC8M0093480	181
865496A01	REC865496A02	277	888756Q01	CMALPHAKITA	289	8M0067062	TENO1320T	287
865496A02	REC865496A02	271	888756Q01	CMALPHAKITM	289	8M0067268	REC57-8M0093495	198
865503T	REC865503T	271	888756Q01	TENKITALPHAONE/2	287	8M0067292	REC8M0093480	181
865735A02	MAR735	233-243	888756Q02	CMALPHAGEN1KITA	289	8M0067625	TENO1320T	287
865876A01	REC865876A01	283	888756Q02	CMALPHAGEN1KITM	289	8M0068784	REC8M0068784	147
866136A01	RM866136A01	277	888756Q03	CMALPHAKITA	289	8M0069803	REC802630T01	129
866169A01	REC866169T01	126	888756Q03	CMALPHAKITM	289	8M0073409	REC17-8M0073409	291
866169T01	REC866169T01	126	888756Q03	RECKITMALPHA2AL	2865	8M0073435	REC8M0073435	125
866169Y01	REC866169T01	128	888756Q03	RECKITMALPHA2M	284-286	8M0077616	REC8M0077616	145
866170A01	REC866170A01	127-128	888756Q03	RECKITMALPHA2ZN	284-286	8M0080805	REC8M0080805	291-296-306-307-308
866171A01	REC35-866171A01	128	888756Q04	TENKITALPHAONE/2	287	8M0082479	PREKM63706	301
866200A01	REC806034A1	293-298	888756Q04	RECKITMALPHA1AL	286	8M0082480	PREKM63707	301
866322A01	RM866322A01	293-298	888756Q04	RECKITMALPHA1M	284-286	8M0082481	PREKM63708	301
86754T	RM86754T	283	888756Q04	RECKITMALPHA1ZN	284-286	8M0082482	PREKM63709	301
86779A1	REC86779A1	277	888758Q01	CMBRAVO1KITA	279-289	8M0082483	PREKM63710	301
86840A05	CEF500509K	299	888758Q01	CMBRAVO1KITM	279-289	8M0082484	PREKM63711	301
86840A05	REC86840A05	297-299	888758Q01	TENKITBRAVOI	279-287	8M0082485	PREKM63712	301
86840A3	CEF500509K	299	888758Q02	RECKITMBRAVO1AL	286	8M0082485	PREKM63713	301
86840A3	REC86840A05	299	888758Q02	RECKITMBRAVO1M	284-286	8M0082486	PREKM63714	301
87-18286A43	REC87-18286A43	160	888758Q02	RECKITMBRAVO1ZN	284-286	8M0082488	PREKM63715	301
87-19674A1	REC87-19674A1	160	888761Q01	CMBRAVO2Y3KITA	281-289	8M0082489	PREKM63716	301
87-71831	REC71831	170	888761Q01	CMBRAVO2Y3KITM	281-289	8M0082490	PREKM63717	301
87-76416A1	REC3853839	157	888761Q02	TENKITBRAVOII-III	281-287	8M0082491	PREKM63718	301
87-805605A1	REC87-805605A1	147	888761Q02	CMBRAVO3KITA	283-289	8M0082492	PREKM63719	301
87-808009A1	RM8M0052936	292	888761Q02	CMBRAVO3KITM	283-289	8M0082493	PREKM63720	301
			888761Q02	TENKITBRAVOIII-04	283-287			



OEM	REF	PAG.	OEM	REF	PAG.	OEM	REF	PAG.
8M0082494	PREKM63721	301	8M0155633	REC8M0155633	186	99438A1	RM99438A1	183
8M0082495	PREKM63722	301	8M2000229	REC10-53728	231-234	99746A17	HOT20952	227-230-243
8M0082496	PREKM63723	301	8M2000819	REC27-33395	209-234	99746A17	MAR746	227-230-243
8M0082497	PREKM63724	301	8M2003959	REC8M2003959	145	99746A3	HOT20952	243
8M0082529	PRE53006	301	8M2003959	REC8M2003959	231-234	99746A3	MAR746	243
8M0082530	PRE53007	301	8M2004414	REC8M2004414	231-234-251	99746A8	HOT20952	243
8M0082531	PRE53008	301	8M2011027	REC8M2011027	263-267-275-279	99746A8	MAR746	243
8M0082532	PRE53009	301	8M2015937	REC8M2015937	269-271	99798A18	HOT20956	242
8M0082533	PRE53010	301	8M2015938	REC8M2015938	269-271	F16900148	REC982209	168
8M0082534	PRE53011	301	8M6000623	REC8M6000623	148	F16900083	REC8M6001249	170
8M0082535	PRE53012	301	8M6000634	REC8M6000634	147	F16900023	REC8M6001249	170
8M0082536	PRE53013	301	8M6000652	REC8M6000652	147	F16900031	REC33662	170
8M0082537	PRE53014	301	8M6000652	REC8M6000652	147	F16900031	REC8M6001219	170
8M0082538	PRE53015	301	8M6001217	REC8M6001217	170	F16900032	REC8M6001249	170
8M0082539	PRE53016	301	8M6001218	REC33662	170	F16900040	REC8M6001217	170
8M0082540	PRE53017	301	8M6001219	REC8M6001219	170	F16900044	REC834975	169
8M0082541	PRE53018	301	8M6001222	REC898253013	169-175	F16900152	REC97258A1	148
8M0082542	PRE53019	301	8M6001224	REC89825302	169	F16900184	REC835702	168
8M0082543	PRE53020	301	8M6001249	REC8M6001249	170	F16900185	REC392-9766	168
8M0082544	PRE53021	301	8M6001250	REC391-5090	170	F16900186	REC3853801	169
8M0082545	PRE53022	301	8M6001251	REC58217	169	F16900189	REC8M6001249	170
8M0082546	PRE53023	301	8M6001252	REC8M6001252	169	F16900190	REC3853801	169
8M0082547	PRE53024	301	8M6001253	REC3854549	169	F16900198	REC97258A1	148
8M0082577	PRE3300C05	301	8M6001253	REC3854549	173	F16901224	REC89825302	169
8M0082578	PRE3300C06	301	8M6001254	REC3854261	169	GM10482803	REC3858984	162
8M0082579	PRE3300C07	301	8M6001254	REC3854261	173			
8M0082580	PRE3300C08	301	8M6002428	REC8M6002428	130			
8M0082581	PRE3300C09	301	8M6003194	REC8M6003194	145			
8M0082582	PRE3300C10	301	8M6005225	REC879194401	185			
8M0082583	PRE3300C11	301	8M6500024	REC8M6500024	193			
8M0082584	PRE3300C12	301	90576A4	REC13524A6	169			
8M0082585	PRE3300C13	301	90736A24	REC90736A24	177			
8M0082586	PRE3300C14	301	90746A1	REC805759Q01	168			
8M0082587	PRE3300C15	301	907964A1	REC807964A1	176			
8M0082588	PRE3300C16	301	91-12037	REC91-12037	313			
8M0082589	PRE3300C17	301	91-17256	REC91-17256	314			
8M0082590	PRE3300C18	301	91-17257T	REC90490	314			
8M0082591	PRE3300C19	301	91-17273	RM91-17273	313			
8M0082592	PRE3300C20	301	91-17275A1	REC91-31107T	313			
8M0082593	PRE3300C21	301	91-17275A1	RM91-17275A1	313			
8M0082594	PRE3300C22	301	91-17302	RM91-17302	313			
8M0082595	PRE3300C23	301	91-36569T	REC91-36569T	310			
8M0082596	PRE3300C24	301	91-43579	REC91-43579	313			
8M0082597	PRE3300C25	301	91-45497A1	REC91-45497A1	312			
8M0082598	PRE3300C26	301	91-56048001	REC91-56048001	312			
8M0082599	PRE3300C27	301	91-56775T	REC91-56775T	312			
8M0082600	PRE3300C28	301	91-60523	REC91-60523	312			
8M0082601	PRE3300C29	301	91-60526T	REC91-60526T	312			
8M0082602	PRE3300C30	301	91-61077T	REC91-61077T	312			
8M0082603	PRE3300C31	301	91-78310	REC91-78310	312			
8M0082604	PRE3300C32	301	91-8053741	REC90490	314			
8M0082605	PRE3300C33	301	91-805475A1	REC91-805475A1	312			
8M0082606	PRE3300C34	301	91-818162	REC91-818162	312			
8M0082607	PRE3300C35	301	91-888863	REC91-888863	173			
8M0082608	REC8M0082988	146	91823A3	REC17177A1	175			
8M0084523	REC882571	154	92497A3	REC78403A2	153			
8M0084884	REC25-8M0084884	183	93320A10	REC93320A15	237-248			
8M0087834	REC8M0087834	144	93320A13	MAR3320PAR	227-237-239-248			
8M0089715	REC8M0089715	182	93320A15	REC93320A15	248			
8M0091470	REC8M0091470	182	93320A5	MAR3320PAR	248			
8M0092489	REC8M0092489	160	93322A12	HOT20985	249			
8M0093480	REC8M0093480	181	93322A12AV	HOT20985	227-237-239			
8M0093561	REC8M0093561	181	94989A6	RM94989A6	291			
8M0094406	REC879194401	185	94998A4	REC94998A4	259			
8M0095310	REC8M0095310	146	95862A5	BAMC-1-95862	221-242			
8M0095310	REC8M0095310	293	96705A1	REC96705A1	219-242			
8M0095310	REC8M0095310	298	97-257	REC806490T	148			
8M0095468	REC8M0142695	145-231	97-8M0151541	TEN01320T	287			
8M0095953	REC8M0095953	231	97257A1	REC806490T	148			
8M0098619	REC8M0098619	143	97258A1	REC97258A1	148			
8M0111642	REC8M0111642	193	97399A2	REC862048A1	124			
8M0113733	REC46-8M0113733	185	97432A2	REC97432A2	217-303			
8M0113734	REC46-8M0113734	185	98-8M0121940	REC98-8M0121940	191			
8M0113736	REC46-8M0113736	185	98230A1	REC98230A1	293-298			
8M0115149	RM807130A4	231-250	98504A3	HOT20970	227-237-239-246			
8M0125617	REC8M0125617	144	98504A3	REC98504A3	23-239-2467			
8M0129714	REC8M0155633	186	98562A6	HOT20937	224-242-246-251			
8M0133370	REC8M0133370	129	98703A26	REC98703A26	308			
8M0142542	REC8M0142542	148	98703A3	REC98703A3	306			
8M0142695	REC8M0142695	145	98704A26	REC98704A26	308			
8M0144930	REC8M0144930	160	98704A3	REC98704A3	306			
8M0148530	REC8M0148530	186	99155T2	REC99155T2	182-224			
8M0148530	SHEP1016	186	99356A1	RM99356A1	184			
8M0148668	REC8M0148668	148-223	99356A2	REC99356A2	184-253			
8M0150234	TEN01320T	287						
8M0153706	MP514516	193						
8M0153706	REC8M0153706	193						

GUÍA MANTENIMIENTO DE MOTORES	346
GUÍA MANTENIMIENTO DE MOTORES	349
GUÍA MANTENIMIENTO TRANSMISIONES	354
KITS MANTENIMIENTO COLAS	355
MATERIALES GENÉRICOS PARA REVISIÓN	353

## SISTEMA ALIMENTACIÓN Y FILTRACIÓN 356

ACEITE VOLVO	590
ACCESORIOS PARA FILTROS	371
BOMBA DE COMBUSTIBLE	372
BOMBA DE ALTA PRESIÓN	374
BOMBA DE BAJA PRESIÓN	375
BOMBA MECÁNICA	372
CARBURADOR	379
BOYAS	381
GUÍA	383
JUNTAS	380
JUNTAS - KITS	381
JUNTAS APAGALLAMAS	383
KITS ADAPTADORES	380
KITS TORNILLOS	379
TUBO COMBUSTIBLE	380
FILTRO DE ACEITE	359
FILTRO DE COMBUSTIBLE Y ELEMENTOS	356
BRACKET	356
FILTRO DECANTADOR, VASO TRASPARENTE	357
FILTRO GASOLINA	358
FILTRO PARA CARBURADOR	358
FILTRO SEPARADOR AGUA	356
RACOR DE LATÓN	357
FILTRO DE ACEITE	366
FILTRO DE AIRE	365
FILTRO DE COMBUSTIBLE Y ELEMENTOS	360
FILTRO CON CAZOLETA	362
FILTRO DECANTADOR	363
FILTRO TIPO SEPAR2000	365
FILTRO DE REFRIGERANTE	369
FILTRO DESVAPORIZADORES	369
INYECTORES	376
ARANDELAS	378
INYECTORES	376
KITS	376
KITS CAMISA	377
RETENES Y TÓRICAS	377
MANGUERA CARBURANTE	370
RACORES	370
TURBO	383
MANGUERA	386

## SISTEMA ELÉCTRICO 387

ALTERNADORES	396
COMPRESOR	392
EMBRAGUE COMPRESOR	392
MÓDULO ELECTRÓNICO	392
MOTORES DE ARRANQUE	393
DESCONECTOR DE SEGURIDAD	395
LLAVES DE ARRANQUE	396
SENSORES	387
AGUA EN COMBUSTIBLE	391
ÁRBOL DE LEVAS	388
BOMBILLA PARA INSTRUMENTOS	392
CIGÜEÑAL Y RPM	392
IAC	387
MAT/MAP	387
PICADO	388
POSICIÓN CIGÜEÑAL	388
POTENCIÓMETRO MANDO	390
PRESIÓN DE ACEITE	389
RAIL DE PRESIÓN	390
REGULADOR DE VOLTAJE	391
TEMPERATURA DE AGUA / AIRE	390
TEMPERATURA Y PRESIÓN ACEITE (ALARMA)	389
TPS	387
SOLENOIDE, RELÉ Y FUSIBLES	405
EXTENSOR DE SOLENOIDE PARA TERMINALES	406
FUSIBLE ATM, ATC, MAXI	408
FUSIBLE TÉRMICO MOTOR	408
FUSIBLE TRIM	408
SOLENOIDES	405
SOLENOIDES ARRANQUE	406
SOLENOIDES PARADA INYECTORA	405
RELÉS	407
RELÉ BOMBA GASOLINA ELÉCTRICA	407

RELÉ CAJA FUSIBLES	406
RELÉ PARADA EMERGENCIA	406
RELÉ STARTER TRIM/TILT	406
TRIM	398
CONVERTIDOR DE 3 A 2 CABLES	398
DESPIECE	402
DEPÓSITO	398
HERRAMIENTA PARA TUERCA	401
KIT REPARACIÓN	402
LATIGUILLOS	404
PISTÓN	401
PULSADOR / INTERRUPTOR	399
SENSOR	399
TRIM COMPLETO	398
TRIM HIDRÁULICO	398
TRIM MECÁNICO	398
TRIM SX	398
TRIM / TILT	398
TUBO CILINDRO	401

## SISTEMA ENCENDIDO 409

BOBINAS	409
ENCENDIDO	409
BUJÍAS	410
CABLES ALTO RENDIMIENTO	412
DISTRIBUIDOR	412
6 CYL	412
4 CYL	413
PRESTOLITE	414
MALLORY	415
4 CYL DELCO	416
V6 DELCO	416
V6 GXI	417
V8 DELCO	417
V8 GXI	418
V8 FORD	418
DESPIECES	420
DISTRIBUIDORES	418
KITS DE CONVERSIÓN ELECTRÓNICO	419
MÓDULOS IGNICIÓN	410

## SISTEMA DE REFRIGERACIÓN 422

BOMBA ASPIRACIÓN DE AGUA	439
IMPULSORES	441
IMPULSORES - GUÍA	442
BOMBA ASPIRACIÓN DE AGUA	443
IMPULSORES	448
IMPULSORES - GUÍA	449
SISTEMAS IPS	447
BOMBA CIRCULACIÓN DE AGUA	433
GUÍA	435
JUNTAS	434
BOMBA CIRCULACIÓN DE AGUA	436
ESTOPADA	437
DESPIECE	437
JUNTAS	438
KITS REPARACIÓN	437
RODAMIENTO	437
RODETE CON EJE	438
BOMBA DE AGUA - COMPONENTES	450
ANILLO TÓRICO TRASERO	452
CENTRADORES BOMBA ASPIRACIÓN	452
CIRCLIP	452
COJINETE	451
CONSOLA	450
JUNTAS TAPA	452
PASADOR EJE	450
PESTAÑA DE SUJECCIÓN	451
PIN CENTRADOR	450
RETENES Y JUNTAS - KITS	453
TAPA DEPÓSITO EXPANSIÓN	451
TOPE	450
TORNILLOS TAPA	451
VÁLVULA DE VACÍO	450
CORREAS Y COMPONENTES	464
GUÍA CORREAS	467
GUÍA CORREAS	468
GUÍA CORREAS SERPENTÍN Y TENSORES	466
GUÍA CORREAS SERPENTÍN Y TENSORES	467
KIT DISTRIBUCIÓN	464
POLEA COMPRESOR ALTERNADOR	465
POLEA RUPTURA	464
PIÑÓN ÁRBOL DE LEVAS	464
PIÑÓN CIGÜEÑAL	464

RODILLO TENSOR	465
TAPÓN SEGURIDAD TAPA DE CORREAS	464
TENSOR CORREA ALTERNADOR	465
TENSOR CORREA COMPRESOR	465
TENSIÓMETRO DISTRIBUCIÓN	465
ENFRIADOR DE ACEITE	431
CARCASA	431
RETENES Y JUNTAS	433
RETENES - KITS	431
ENFRIADOR DE AIRE	430
JUNTAS	431
INTERCAMBIADOR DE CALOR	426
FILTRO AGUA SALADA	430
INTERCAMBIADOR DE AGUA	429
INTERCOOLER	429
JUNTAS	428
KITS	426
KITS REPARACIÓN	454
MANGUITOS MOTOR	463
RETENES	457
ADMISIÓN AIRE	461
BOMBA	458
COLECTOR ESCAPE	462
CUERNO ESCAPE	462
CUERPO TERMOSTATO	457
DISTRIBUIDOR	458
EJE	457
ENFRIADOR	461
INFERIOR DEL FILTRO	457
INTERCAMBIADOR	461
RETENES TUBOS REFRIGERACIÓN	459
RETENES TUBOS REFRIGERACIÓN - KITS	459
RETENES TUBOS REFRIGERACIÓN - KITS	460
SISTEMA LUBRICACIÓN	462
SISTEMA REFRIGERACIÓN	461
TAPONES DRENAJE	462
TERMOSTATO	422
CUERPOS	423
JUNTAS	426
RETÉN SOPORTE DOBLE TERMOSTATO	425
TERMOSTATOS - KITS	423

## PARTES DEL MOTOR 470

JUNTAS MOTOR	480
ADMISIÓN	482
CARTER	483
CULATA	480
ESCAPE	482
PARTE INFERIOR - KITS	483
PARTE SUPERIOR - KITS	480
PORTARETÉN TRASERO CIGÜEÑAL	482
TAPA BALANCINES	482
TAPA DISTRIBUCIÓN	481
JUNTAS MOTOR	484
CARTER	495
CULATA	484
ESCAPE	492
PARTE INFERIOR - KITS	495
PARTE SUPERIOR - KITS	487
RETENES CIGÜEÑAL	498
RETENES TAPA BALANCINES	492
RETENES TAPA LATERAL BLOQUE	492
TAPA BALANCINES	490
TAPA DISTRIBUCIÓN	494
TAPA TRASERA CIGÜEÑAL	495
TURBO	493
JUNTAS PARA BASES GM Y FORD	470
PISTONES - KITS	499
AROS	499
BASE VOLVO	499
COJINETES ÁRBOL DE LEVAS	501
COJINETES BANCADA	500
COJINETES BIELA	500
PISTONES - KITS	501
AROS	502
CAMISAS	502
COJINETES BANCADA	503
COJINETES BIELA	505
GOMAS CAMISAS	501
PISTONES	501
RETENES BOMBA DE ACEITE	506
VÁLVULAS	507
RETENES	507
RETENES	507



# VOLVO

<b>SISTEMA ESCAPE Y ADMISIÓN</b>	<b>508</b>
COLECTOR ADMISIÓN	518
<b>COLECTORES Y CODOS</b>	<b>520</b>
CODOS	522
CUERNOS ESCAPE	522
EXTENSOR DE ESCAPE	523
KIT RISER 6"	523
<b>COLECTORES Y CODOS</b>	<b>524</b>
ABRAZADERA ESCAPE	525
CODO ESCAPE INOX	526
CODO ESCAPE - GUÍA	527
KIT REPARACIÓN TUBO ESCAPE	528
MANGUITO ESCAPE	528
PIPA CONEXIÓN	526
<b>COMPONENTES DE FIJACIÓN</b>	<b>508</b>
GUÍA COMPONENTES	509
<b>DESPIECES COLECTORES Y CODOS</b>	<b>510</b>
AQ115A, B • BB115A, B, C • AQ130A, B, C, D	519
AQ120B • AQ125A, B • AQ131A, B, C, D • AQ140A • BB140A • AQ145A, B • BB145A • AQ151A, B, C • 230A, B • 250A, B	510
3.0I GM	511
6L AQ 165 & 170 A, B, C	512
V6 AQ 175 • AQ 205 • AQ430 A/B • 431 A/B • AQ 434	512
V6 4.3L GM 262 CID	513
AQ & BB 200, 205, 211, 231, 225, 260, 271, 290, 311, 500, 501, 570, 571, 572 GM 305/350 CID,	514
V8 5.0/5.7L GM305 & GM 350 CID	515
5.0/5.8L & Fi/FSi FORD 302/351 CID V8	516
V8 7.4/8.2 GM 454/502 CID	517
VÁLVULAS ADMISIÓN Y ESCAPE	518

COMPONENTES	519
<b>UNIDADES DE TRANSMISIÓN</b>	<b>529</b>
<b>MODELOS DE COLAS Y ACEITE</b>	<b>532</b>
ACOPLIAMIENTOS MOTOR	585
ÁNODOS	557
ÁNODO CANADA METAL	565
ÁNODO RECMAR	558
ÁNODO TECNOSEAL	560
<b>CAMBIO</b>	<b>584</b>
DAMPER	585
<b>DESPIECE COLAS</b>	<b>534</b>
IPS-A, B, C, D, E, F	534
VELEROS 120, 130, 150, M525	535
XDP	536
DPH / DPR	538
AQUAMATIC (SUPERIOR)	540
SX (SUPERIOR)	542
SX-A, FWD, DPS-A, DPS-B (SUPERIOR)	544
DP-G, DPX-A (SUPERIOR)	545
AQUAMATIC (INFERIOR)	546
AQUAMATIC DP (INFERIOR)	547
SX (INFERIOR)	548
DP-S (INFERIOR)	549
DP-SM (INFERIOR)	550
DPS-A, DPS-B (INFERIOR)	552
SX-A (INFERIOR)	553
FWD (INFERIOR)	554
AQUAMATIC (INTERMEDIA)	555
DP-E, DP-G, DP-C, DP-D (INTERMEDIA)	556
<b>PISTONES DIRECCIÓN Y COMPONENTES</b>	<b>529</b>
ACTUADOR	529
BOMBA HIDRÁULICA	530

CABLE CONTROL 33C	531
CABLE RUDDER	531
EXTRACTOR POLEA BOMBA DIRECCIÓN	530
FUELLES	530
KIT REPARACIÓN	530
LATIGUILLOS DIRECCIÓN	529
PISTONES	529
POLEA PARA SERVO Y BOMBA	531
<b>PRENSAESTOPAS - KIT</b>	<b>585</b>
<b>SOPORTE MOTOR</b>	<b>584</b>
<b>TRANSOM</b>	<b>577</b>
DP-S	577
SX	578
SX-A TSK	579
<b>TRANSOM - COMPONENTES</b>	<b>580</b>
GOMAS	581
FUELLES DE TRANSMISIÓN	582
MANGUITOS DE COLA	583
RODAMIENTOS EJE	581
RODAMIENTOS Y RETENES - GUÍA	580
<b>REPARACIÓN AQUAMATIC - COMPONENTES</b>	<b>568</b>
<b>REPARACIÓN SX - COMPONENTES</b>	<b>571</b>
<b>REPARACIÓN COLAS E INVERSORES - KITS</b>	<b>571</b>
<b>RETENES Y TÓRICAS</b>	<b>576</b>

<b>SISTEMA DE PROPULSIÓN</b>	<b>586</b>
<b>HÉLICES SOLAS</b>	<b>586</b>
<b>HÉLICES ORIGINALES VOLVO</b>	<b>588</b>
<b>REF --&gt; RO</b>	<b>593</b>
<b>RO --&gt; REF</b>	<b>605</b>

EN

DRIVES MAINTENANCE KIT	355
GENERIC MATERIALS FOR REVISION	353
<b>GUIDE: ENGINE MAINTENANCE</b>	<b>346</b>
<b>GUIDE: ENGINE MAINTENANCE</b>	<b>349</b>
<b>GUIDE: MAINTENANCE TRANSMISSIONS</b>	<b>354</b>
<b>FUEL &amp; FILTRATION SYSTEM</b>	<b>356</b>
AIR FILTER	365
AIR FILTER CARTER	369
CARBURETOR	379
ADAPTER KITS	380
FLAME ARRESTORS	383
FLOATS	381
FUEL TUBE	380
GASKETS	380
GASKETS - KITS	381
GUIDE	383
SCREW KITS	379
<b>COOLANT FILTER</b>	<b>369</b>
<b>FILTERS - ACCESSORIES</b>	<b>371</b>
<b>FUEL FILTERS AND ELEMENTS</b>	<b>356</b>
BRACKET	356
BRASS RACCORS	357
CARBURETOR FUEL FILTER	358
COMPLETE FUEL FILTER	357
FUEL FILTER	358
WATER SEPARATING FUEL FILTER	356
<b>FUEL FILTERS AND ELEMENTS</b>	<b>360</b>
BOWLS FILTER	362
COMPLETE FUEL FILTER	363

FILTER TYPE SEPAR2000	365
<b>FUEL PUMP</b>	<b>372</b>
HIGH PRESSURE	374
LOW PRESSURE	375
MECHANICAL	372
<b>FUEL TUBE</b>	<b>370</b>
INJEKTOR	376
KITS	376
SEALS & WHASERS	378
SLEEVE KITS	377
WASHERS	378
<b>OIL FILTER</b>	<b>359</b>
<b>OIL FILTER</b>	<b>366</b>
RACORS	370
TURBO	383
TUBE	386
<b>VOLVO OIL</b>	<b>590</b>

<b>ELECTRIC SYSTEM</b>	<b>387</b>
ALTERNATORS	396
COMPRESSOR	392
ELECTRONIC MODULE	392
SOLENOID CLUTCH	392
STARTERS	393
CUT OFF SWITCH	395
START KEYS	396
<b>SENSORS</b>	<b>387</b>
AIR / WATER TEMPERATURE	390
BULB WATCH INSTRUMENTS	392
CAMSHAFT	388
COMPLETE TEMPERATURE & OIL PRESSURE WARNING KIT	389

CONTROL POTENTIOMETER	390
CRANKSHAFT	388
CRANKSHAFT & RPM	392
IAC	387
KNOCK	388
MAT/MAP	387
OIL PRESSURE	389
OIL PRESSURE WARNING	391
TPS	387
VOLTAGE REGULATOR	391
WATER IN FUEL	391
<b>SOLENOID, RELAY &amp; FUSES</b>	<b>405</b>
FUSES - ATM, ATC, MAXI	408
FUSES - IGNITION CIRCUIT BREAKER	408
FUSES - TRIM	408
RELAY	407
RELAY - EMERGENCY STOP	407
RELAY - FUSES BOX	406
RELAY - FUEL ELECTRIC PUMP	407
RELAY - TRIM/TILT STARTER	406
SOLENOID	405
SOLENOID EXTENSOR FOR TERMINALS	406
SOLENOID - STARTER	406
SOLENOID - STOP	405
<b>TRIM</b>	<b>398</b>
3 TO 2 WIRE WIRED CONVERTER	399
CYLINDER TUBE	401
HYDRAULIC MOTOR	398
HOSES	404
MECHANICAL MOTOR	399
PARTS	402
PISTON	401
REPAIR KIT	402



RESERVOIR	399
SENSOR	400
SWITCH	400
SX	399
TOOL FOR END NUT	401
TRIM / TILT	399

## IGNITION SYSTEM 409

COILS	409
IGNITION	409
DISTRIBUTOR	412
6 CYL	412
4 CYL	413
PRESTOLITE	414
MALLORY	415
4 CYL DELCO	416
V6 DELCO	416
V6 GXI	417
V8 DELCO	417
V8 GXI	418
V8 FORD	418
DISTRIBUTORS	418
ELECTRONIC CONVERSION KITS	419
PARTS	420
IGNITION MODULES	410
SPARK PLUG	410
HD SPARK PLUG WIRES SET	412

## COOLING SYSTEM 422

AFTERCOOLER	430
GASKETS	431
BELTS & COMPONENTS	464
ALTERNATOR BELT TENSIONER D4/D6	465
COMPRESSOR BELT TENSIONER D4/D6	465
CRANKSHAFT GEAR	464
PLUG SAFETY COVER BELTS	464
RUPTURE PULLEY	464
SERPENTINE BELTS & TENSIONERS - GUIDE	466
SERPENTINE BELTS & TENSIONERS - GUIDE	467
TENSIONER	465
TENSIONES ROLLER	465
TIMING BELT KIT	464
V-BELTS - GUIDE	467
V-BELTS - GUIDE	468
HEAT EXCHANGER	426
GASKETS	428
INTERCOOLER	429
KITS	426
SEA WATER FILTER	430
WATER EXCHANGER	429
HOSES MOTOR	463
OIL COOLER	431
HOUSING	431
SEALS & GASKETS	433
SEALS - KITS	432
RAPAIR KITS	454
SEALS	457
AIR INTAKE	461
COOLER	461
COOLING SYSTEM	461
DISTRIBUTOR	458
DRAIN TAPS	462
ENGINE HOSE SEALS	459
ENGINE HOSE SEALS - KITS	459
ENGINE HOSE SEALS - KITS	460
EXCHANGER	461
EXHAUST MANIFOLD	462
EXHAUST TUBE	462
LOWER SEAL OLD WATER FILTER	457
LUBRICATION SYSTEM	462
PUMP	458
SHAFT	457
THERMOSTAT HOUSING	457
THERMOSTAT WATER TUBE	460
THERMOSTAT	422
DOUBLE THERMOSTAT SUPPORT GASKET	425
GASKETS	426
HOUSING	423
THERMOSTATS - KITS	423
WATER PUMP - BLOCK CIRCULATING	433
GASKETS	434
GUIDE	435
WATER PUMP - BLOCK CIRCULATING	436
BEARING	437
GASKETS	438

GUIDE	437
IMPELLER & SHAFT	438
REPAIR KIT	437
WATER PUMP - COMPONENTS	450
BACK O-RING	452
BEARING	451
CONSOLE	450
CIRCLIP	452
EXPANSION DEPOSIT COVER	451
GASKETS - KITS	453
GASKETS- PUMP COVER	452
IMPELLER GASKET COVER	452
LOOKING PING	450
MOUNTING CLAMP FOR BALL BEARING	451
PIN	450
SCREW PUMP COVER	451
STOP	450
VACUUM VALVE	450
WATER PUMP CROSS PIECES	452
WATER PUMP - RAW MARINE	439
IMPELLERS	441
IMPELLERS - GUIDE	442
WATER PUMP - RAW MARINE	443
IMPELLERS	448
IMPELLERS - GUIDE	449
IPS SYSTEM	447

## ENGINE PARTS 470

ENGINE GASKETS	480
CONVERSION GASKET KIT	483
CRANKSHAFT REAR SEAL GASKET	482
CYLINDER HEAD	480
EXHAUST GASKET	482
GASKET HEAD - KITS	480
INTAKE	482
OIL PAN	483
TIMING COVER	481
VALVE COVER	482
ENGINE GASKETS	484
OIL PAN	495
CONVERSION GASKET KIT	495
CRANKSHAFT	498
CYLINDER HEAD	484
EXHAUST	492
GASKET HEAD - KITS	487
REAR CRANKSHAFT COVER GASKET	495
SIDE COVER BLOCK	492
TIMING COVER	494
TURBO	493
VALVE COVER	490
VALVE COVER SEALS	492
GASKETS TO GM & FORD ENGINES	470
OIL PUMP SEALS	506
PISTONS - KITS	499
BEARING KITS FOR CAMSHAFT	500
CONNECTING ROD BEARING KITS	500
MAIN BEARING KITS	500
RING SET	499
VOLVO BASE	499
PISTONS - KITS	501
CONNECTING ROD BEARING KITS	505
CYLINDER LINER	502
CYLINDER LINER KITS	501
MAIN BEARING KITS	503
PISTONS	501
RING SET	502
VALVES	507

## EXHAUST & INTAKE SYSTEM 508

INTAKE & EXHAUST VALVES	518
COMPONENTS	519
INTAKE MANIFOLD	518
FIXING COMPONENTS	508
GUIDE	509
MANIFOLDS & ELBOWS	520
ELBOWS	522
EXHAUST TUBO SX	522
EXHAUST EXTENSOR	523
RISER 6"	523
MANIFOLDS & ELBOWS	524
CONNECTOR FOR ELBOW	526
EXHAUST BELLOW KIT	524
EXHAUST CLAMP	525
EXHAUST ELBOW - 316 SS	526
EXHAUST ELBOW - GUIDE	527

EXHAUST HOSE	528
EXHAUST HOSE - REPAIR KIT	528
PARTS - MANIFOLDS & ELBOW	510
AQ115A, B • BB115A, B, C • AQ130A, B, C, D	519
AQ120B • AQ125A, B • AQ131A, B, C, D • AQ140A • BB140A • AQ145A, B • BB145A • AQ151A, B, C • 230A, B • 250A, B	510
3.0I GM	511
6L AQ 165 & 170 A, B, C	512
V6 AQ 175 • AQ 205 • AQ430 A/B • 431 A/B • AQ 434	512
V6 4.3L GM 262 CID	513
AQ & BB 200, 205, 211, 231, 225, 260, 271, 290, 311, 500, 501, 570, 571, 572 GM 305/350 CID,	514
V8 5.0/5.7L GM305 & GM 350 CID	515
5.0/5.8L & Fi/Fsi FORD 302/351 CID V8	516
V8 7.4/8.2 GM 454/502 CID	517

## TRANSMISSION UNIT 586

STERNDRIVES MODELS AND OILS	532
ANODES	557
CANADA METAL	565
RECMAR	558
TECNOSEAL	560
BELLOWS	582
DRIVE BELLOW	583
DRIVE HOSE	583
DAMPER	585
ENGINE COUPLER ASSEMBLIES	585
ENGINE MOUNT SCREW	584
GEARCASES PARTS	534
IPS-A, B, C, D, E, F	534
SAILBOAT 120, 130, 150, M525	535
XDP	536
DPH / DPR	538
AQUAMATIC (UPPER HOUSING)	540
SX (UPPER HOUSING)	542
SX-A, FWD, DPS-A, DPS-B (UPPER HOUSING)	544
DP-G, DPX-A (UPPER HOUSING)	545
AQUAMATIC (LOWER HOUSING)	546
AQUAMATIC DP (LOWER HOUSING)	547
SX (LOWER HOUSING)	548
DP-S (LOWER HOUSING)	549
DP-SM (LOWER HOUSING)	550
DPS-A, DPS-B (LOWER HOUSING)	552
SX-A (LOWER HOUSING)	553
FWD (LOWER HOUSING)	554
AQUAMATIC (INTERMEDIATE HOUSING)	555
DP-E, DP-G, DP-C, DP-D (INTERMEDIATE HOUSING)	556
REPAIR KIT COMPONENTS - AQUAMATIC	568
REPAIR KIT COMPONENTS - SX COBRA	571
REPAIR KIT - STERN DRIVES & INVERTERS	571
RUBBER SEAL - KIT	585
SEALS & RUBBER O-RINGS	576
TRANSOM	577
DP-S	577
SX	578
SX-A TSK	579
TRANSOM - COMPONENTS	580
SEALING STRIPS	581
SHAFT BELL SEAL	581
SHAFT CLIP	581
SHAFT BEARING	581
RUBBER RING	581
RUBBER LOCK- IPS	581
SHIFT	584
STEERING PISTONS & COMPONENTS	529
ACTUATOR	529
HYDRAULIC STEERING PUMP	530
BELLOWS	530
CABLE - CONTROL 33C	531
CABLE - RUDDER	531
HYDRAULIC HOSES	529
PISTON REPAIR KIT	530
PULLEY FOR SERVO PUMP	531
PULLEY REMOVER	530

## PROPULSION SYSTEM 586

PROPELLERS - SOLAS	586
ORIGINAL PROPELLER - VOLVO	588
REF --> RO	593
RO --> REF	605







<b>SYSTÈME D'ALLUMAGE</b>	<b>409</b>
BOBINE	409
BOUGIES	410
KIT FAISCEAU DE BOUGIE	410
DISTRIBUTEUR	412
6 CYL	412
4 CYL	413
PRESTOLITE	414
MALLORY	415
4 CYL DELCO	416
V6 DELCO	416
V6 GXI	417
V8 DELCO	417
V8 GXI	418
V8 FORD	418
ALLUMEUR	418
KITS DE CONVERSION ÉLECTRONIQUE	419
PIÈCES	420
MODULES D'ALLUMAGE	410

<b>SYSTÈME DE REFFROIDISSEMENT</b>	<b>422</b>
BAGUE	457
ADMISSION D'AIR	461
BOUCHONS DE VIDANGE	462
COLLECTEUR D'ÉCHAPPEMENT	462
CORNE D'ÉCHAPPEMENT	462
CORPS DE THERMOSTAT	457
DISTRIBUTEUR	458
ÉCHANGEUR	461
INFÉRIEUR DU FILTRE	457
JOINTS TUYAUX DE REFFROIDISSEMENT	459
JOINTS TUYAUX DE REFFROIDISSEMENT - KITS	459
JOINTS TUYAUX DE REFFROIDISSEMENT - KITS	460
POMPA	458
REFFROIDISSEUR	461
SYSTÈME DE LUBRIFICATION	462
SYSTÈME DE REFFROIDISSEMENT	461
TUYAU D'EAU THERMOSTAT	460
COURROIES ET COMPOSANTS	464
BOUCHON D'ÉTANCHÉITÉ	464
GALET TENDEUR	465
GUIDE DE COURROIES MOTEUR	467
GUIDE DE COURROIES MOTEUR	468
GUIDE DE COURROIES SERPENTINE	466
GUIDE DE COURROIES SERPENTINE	467
KIT DISTRIBUTION	464
PIGNON D'ARBRE À CAME	464
PIGNON DE VILEBREQUIN	464
POULIE	465
POULIE DU COMPRESSEUR ALTERNATEUR	465
TENDEUR	465
TENDEUR DE COURROIE D'ALTERNATEUR	465
TENDEUR DE COURROIE DE COMPRESSEUR	465
DURITE MOTEUR	463
ÉCHANGEUR DE CHALEUR	426
ÉCHANGEUR D'EAU	429
FILTRE EAU DE MER	430
INTERCOOLER	429
JOINTS	428
KITS	426
KITS RÉPARATION	454
POMPE À EAU DE MER	439
TURBINES	441
TURBINES - GUIDE	442
POMPE À EAU DE MER	443
TURBINES	448
TURBINES - GUIDE	449
SYSTÈMES IPS	447
POMPE DE BRASSAGE	433
GUIDE	435
JOINTS	434
POMPE DE BRASSAGE	436
JOINTS	437
KITS	437
ROULEMENT	437
TURBINE	438
POMPE D'EAU - COMPOSANTS	450
BOUCHON DE VASE D'EXPANSION	451
BUTÉE	450
BRIDE DE POMPE	451
CIRCLIP	452
CLAVETTE	450

JOINT DE COUVERCLE DE TURBINE	454
JOINT TORIQUE ARRIÈRE	452
JOINTS - KITS	453
PIN DE CENTRAGE	450
ROULEMENT	451
SUPPORT DE POMPE	450
TOC D'ENTRAÎNEMENT DE POMPE	452
VANNE À CACUUM	450
VIS DE COUVERCLE	451
REFROIDISSEUR D'AIR	430
JOINTS	431
REFROIDISSEUR D'HUILE	431
CARTER	431
JOINTS SPI ET TORIQUES	433
JOINTS - KITS	432
THERMOSTAT	422
CORPS	423
JOINTS	426
JOINTS DU SUPPORT DOUBLE THERMOSTAT	425
THERMOSTAT - KITS	423

<b>PIÈCES MOTEUR</b>	<b>470</b>
JOINTS DE POMPE À HUILE	506
JOINTS POUR MOTEUR	480
ADMISSION	482
CARTER	483
CULASSE	480
ÉCHAPPEMENT	483
JOINT ARRIÈRE DE VILEBREQUIN	482
JOINT CARTER DE DISTRIBUTION	481
JOINT DE CACHE CULBUTEUR	482
POCHETE BASSE	483
POCHETE HAUTE	480
JOINTS POUR MOTEUR	484
CACHE CULBUTEUR	490
CARTER D'HUILE	495
CARTER	494
COUVERCLE ARRIÈRE DE VILEBREQUIN	495
COUVERCLE LATERAL DU BLOC	492
CULASSE	484
JOINT SPI DE CACHE CULBUTEUR	492
POCHETE BASSE	495
POCHETE HAUTE	487
TURBO	493
VILEBREQUIN	498
JOINTS POUR MOTEUR GM ET FORD	470
PISTONS - KITS	499
BASE VOLVO	499
COUSSINETS D'ARBRE À CAMMES	501
COUSSINETS DE VILEBREQUIN	500
COUSSINETS DE BIELLE	502
SEGMENTS	499
PISTONS - KITS	501
CHEMISE	502
COUSSINETS DE VILEBREQUIN	503
COUSSINETS DE BIELLE	505
JOINTS DE CHEMISE	501
PISTONS	501
SEGMENTS	502
SOUPAPES	507

<b>SYSTÈME ÉCHAPPEMENT ET ADMISSION</b>	<b>508</b>
COLLECTEUR ADMISSION	518
COLLECTEURS ET COUDES	520
COUDES	522
CORNES D'ÉCHAPPEMENT	522
KIT REHAUSSE 6"	523
COLLECTEURS ET COUDES	524
DURITE D'ÉCHAPPEMENT	528
COLLIER D'ÉCHAPPEMENT	525
COUDE D'ÉCHAPPEMENT - INOX	526
COUDE D'ÉCHAPPEMENT - GUIDE	527
KIT RÉPARATION POUR CORNE D'ÉCHAPPEMENT	528
COMPOSANTS DE FIXATION	508
GUIDE	509
PIÈCES COLLECTEURS ET COUDES	510
AQ115A, B • BB115A, B, C • AQ130A, B, C, D	519
AQ120B • AQ125A, B • AQ131A, B, C, D • AQ140A • BB140A • AQ145A, B • BB145A • AQ151A, B, C • 230A, B • 250A, B	510
3.0l GM	511
6L AQ 165 Et 170 A, B, C	512
V6 AQ 175 • AQ 205 • AQ430 A/B • 431 A/B • AQ 434	512

V6 4.3L GM 262 CID	513
AQ Et BB 200, 205, 211, 231, 225, 260, 271, 290, 311, 500, 501, 570, 571, 572 GM 305/350 CID,	514
V8 5.0/5.7L GM305 Et GM 350 CID	515
5.0/5.8L Et Fi/Fsi FORD 302/351 CID V8	516
V8 7.4/8.2 GM 454/502 CID	517
SOUPAPES D'ADMISSION ET D'ÉCHAPPEMENT	518
COMPOSANTS	519

<b>EMBASES ET PIÈCES</b>	<b>529</b>
MODÈLES D'EMBASES ET D'HUILE	532
ACCOUPLÉMENT MOTEUR	585
ANODES	557
ANODE CANADA METAL	565
ANODE RECMAR	558
ANODE TECNOSÉAL	560
CHANGEMENT	584
DAMPER	585
DURITES D'EMBASES	583
JOINTS SPI ET JOINTS TORIQUES	576
PIÈCES D'EMBASES	534
IPS-A, B, C, D, E, F	534
SAIL DRIVE 120, 130, 150, M525	535
XDP	536
DPH / DPR	538
AQUAMATIC (SUPÉRIEURE)	540
SX (SUPÉRIEURE)	542
SX-A, FWD, DPS-A, DPS-B (SUPÉRIEURE)	544
DP-G, DPX-A (SUPÉRIEURE)	545
AQUAMATIC (INFÉRIEUR)	546
AQUAMATIC DP (INFÉRIEUR)	547
SX (INFÉRIEUR)	548
DP-S (INFÉRIEUR)	549
DP-SM (INFÉRIEUR)	550
DPS-A, DPS-B (INFÉRIEUR)	552
SX-A (INFÉRIEUR)	553
FWD (INFÉRIEUR)	554
AQUAMATIC (INTERMÉDIAIRE)	555
DP-E, DP-G, DP-C, DP-D (INTERMÉDIAIRE)	556
PRESSE ETOUPE - KIT	585
RÉPARATION AQUAMATIC - COMPOSANTS	568
RÉPARATION SX COBRA - COMPOSANTS	571
RÉPARATION EMBASES ET INVERSEURS - KITS	571
SUPPORT MOTEUR	584
TRANSOM	577
DP-S	577
SX	578
SX-A TSK	579
TRANSOM - COMPOSANTS	580
JOINTS	581
SOUFFLET DE CARDAN	582
ROULEMENT D'ARBRE	581
ROULEMENTS ET JOINTS SPI - KITS	580
VERIN ET COMPOSANTS DE DIRECTION	529
ACTIONNEUR	529
CÂBLE DE COMMANDE 33c	531
CÂBLE RUDDER	531
FLEXIBLES	529
KIT RÉPARATION	530
POMPE HYDRAULIQUE	530
POULIE DE SERVO POMPE	531
SERVO POMPE	531
EXTRACTEUR POULIE	530
SOUFFLET	530

<b>SYSTÈME DE PROPULSION</b>	<b>586</b>
HÉLICES SOLAS	586
HÉLICES ORIGINALES VOLVO	588
REF --> RO	593
RO --> REF	605



		REF				
AQ95		REC3517857	FILTRO ACEITE	OIL FILTER	FILTRO OLIO	FILTRE A HUILE
AQ100		REC3581078	FILTRO COMBUSTIBLE	FUEL FILTER	FILTRO COMBUSTIBILE	FILTRE A ESSENCE
AQ110		JOH09-1026B	IMPULSOR	IMPELLER	GIRANTE	TURBINE
AQ115		REC876080	TERMOSTATO	THERMOSTAT	TERMOSTATO	THERMOSTAT
AQ120A		REC966891	CORREA	BELT	CINGHIA	COURROIE
AQ130		NGKBP7HS	BUJÍAS	SPARK PLUGS	CANDELE	BOUGIES
AQ170A, B, C		REC3517857	FILTRO ACEITE	OIL FILTER	FILTRO OLIO	FILTRE A HUILE
		REC3581078	FILTRO COMBUSTIBLE	FUEL FILTER	FILTRO COMBUSTIBILE	FILTRE A ESSENCE
		JOH09-801B	IMPULSOR	IMPELLER	GIRANTE	TURBINE
		REC875791	TERMOSTATO	THERMOSTAT	TERMOSTATO	THERMOSTAT
		REC966694	CORREA	BELT	CINGHIA	COURROIE
		NGKBP7HS	BUJÍAS	SPARK PLUGS	CANDELE	BOUGIES
AQ120B		REC3517857	FILTRO ACEITE	OIL FILTER	FILTRO OLIO	FILTRE A HUILE
AQ125A, B		REC3581078	FILTRO COMBUSTIBLE	FUEL FILTER	FILTRO COMBUSTIBILE	FILTRE A ESSENCE
AQ131A, B, C, D		JOH09-801B	IMPULSOR	IMPELLER	GIRANTE	TURBINE
230A, B		REC875580	TERMOSTATO 82°	THERMOSTAT 82°	TERMOSTATO 82°	THERMOSTAT 82°
AQ140A	120A/B, 125A/B,	REC966694	CORREA	BELT	CINGHIA	COURROIE
AQ145A, B	140A, 145A	REC966891	CORREA	BELT	CINGHIA	COURROIE
AQ151A, B, C	130B/C	REC966382	CORREA	BELT	CINGHIA	COURROIE
AQ250, A, B	131A/B/C/D, 145B,	NGKBP7HS	BUJÍAS	SPARK PLUG	CANDELE	BOUGIES
	151A/B/C	NGKBP7HS	BUJÍAS	SPARK PLUG	CANDELE	BOUGIES
	AQ120, 125A/B, 145					
	AQ131A/B/C, 140A,					
	151A/B/C, 230A, 250A/B					
AQ255A, B		REC35-06003	FILTRO ACEITE	OIL FILTER	FILTRO OLIO	FILTRE A HUILE
		REC982230	FILTRO COMBUSTIBLE	FUEL FILTER	FILTRO COMBUSTIBILE	FILTRE A ESSENCE
	AQ255A	SHE09959K	IMPULSOR	IMPELLER	GIRANTE	TURBINE
	AQ255B	JOH09-1027B	IMPULSOR (Ancho 31 mm)	IMPELLER (Width 31 mm)	GIRANTE (Largh. 31 mm)	TURBINE (Largeur 31 mm)
	AQ255B	REC22120-0001	IMPULSOR (Ancho 50 mm)	IMPELLER (Width 50 mm)	GIRANTE (Largh. 50 mm)	TURBINE (Largeur 50 mm)
		REC876305	TERMOSTATO 62°	THERMOSTAT 62°	TERMOSTATO 62°	THERMOSTAT 62°
		REC978750	CORREA	BELT	CINGHIA	COURROIE
		NGKUR6	BUJÍAS	SPARK PLUG	CANDELE	BOUGIES
AQ225B, C, D, E, F		REC35-06003	FILTRO ACEITE	OIL FILTER	FILTRO OLIO	FILTRE A HUILE
AQ231A, B		REC982230	FILTRO COMBUSTIBLE	FUEL FILTER	FILTRO COMBUSTIBILE	FILTRE A ESSENCE
BB231A		REC3581078	FILTRO COMBUSTIBLE	FUEL FILTER	FILTRO COMBUSTIBILE	FILTRE A ESSENCE
	B, C	SHE09959K	IMPULSOR	IMPELLER	GIRANTE	TURBINE
	D, E, F	REC22120-0001	IMPULSOR	IMPELLER	GIRANTE	TURBINE
		REC876305	TERMOSTATO 62°	THERMOSTAT 62°	TERMOSTATO 62°	THERMOSTAT 62°
		REC978750	CORREA (Bomba alternador)	BELT (Alternator pump)	CINGHIA (Pompe alter.)	COURROIE (Pompe alter.)
		GDY17291	CORREA (Dirección)	BELT (Steering)	CINGHIA (Sterzo)	COURROIE (Direction)
	AQ225A/B/C/D	NGKUR6	BUJÍAS	SPARK PLUG	CANDELE	BOUGIES
	AQ225E/F, 231A/B, BB231A	NGKYR5	BUJÍAS	SPARK PLUG	CANDELE	BOUGIES
AQ260A, B		REC35-06003	FILTRO ACEITE	OIL FILTER	FILTRO OLIO	FILTRE A HUILE
BB260A, B, C		REC982230	FILTRO COMBUSTIBLE	FUEL FILTER	FILTRO COMBUSTIBILE	FILTRE A ESSENCE
		REC3581078	FILTRO COMBUSTIBLE	FUEL FILTER	FILTRO COMBUSTIBILE	FILTRE A ESSENCE
		JOH09-1027B	IMPULSOR (Ancho 31 mm)	IMPELLER (Width 31 mm)	GIRANTE (Largh. 31 mm)	TURBINE (Largeur 31 mm)
		REC22120-0001	IMPULSOR (Ancho 50 mm)	IMPELLER (Width 50 mm)	GIRANTE (Largh. 50 mm)	TURBINE (Largeur 50 mm)
		REC876305	TERMOSTATO 62°	THERMOSTAT 62°	TERMOSTATO 62°	THERMOSTAT 62°
		REC978750	CORREA	BELT	CINGHIA	COURROIE
		NGKBR6FS	BUJÍAS	SPARK PLUG	CANDELE	BOUGIES
AQ271A, B, C, D		REC35-06003	FILTRO ACEITE	OIL FILTER	FILTRO OLIO	FILTRE A HUILE
BB261A		REC85686	FILTRO COMBUSTIBLE	FUEL FILTER	FILTRO COMBUSTIBILE	FILTRE A ESSENCE
		REC3581078	FILTRO COMBUSTIBLE	FUEL FILTER	FILTRO COMBUSTIBILE	FILTRE A ESSENCE
		JOH09-1027B	IMPULSOR (Ancho 31 mm)	IMPELLER (Width 31 mm)	GIRANTE (Largh. 31 mm)	TURBINE (Largeur 31 mm)
		REC22120-0001	IMPULSOR (Ancho 50 mm)	IMPELLER (Width 50 mm)	GIRANTE (Largh. 50 mm)	TURBINE (Largeur 50 mm)
		REC876305	TERMOSTATO 62°	THERMOSTAT 62°	TERMOSTATO 62°	THERMOSTAT 62°
		REC978750	CORREA (Bomba alternador)	BELT (Pump alternator)	CINGHIA (Pompa altern.)	COURROIE (Pompe altern.)
		REC967111	CORREA (Dirección)	BELT (Steering)	CINGHIA (Sterzo)	COURROIE (Direction)
		NGKBR6FS	BUJÍAS	SPARK PLUG	CANDELE	BOUGIES
430, 431, 432, 434		REC841750	FILTRO ACEITE	OIL FILTER	FILTRO OLIO	FILTRE A HUILE
		REC85686	FILTRO COMBUSTIBLE	FUEL FILTER	FILTRO COMBUSTIBILE	FILTRE A ESSENCE
		REC3581078	FILTRO COMBUSTIBLE	FUEL FILTER	FILTRO COMBUSTIBILE	FILTRE A ESSENCE
		JOH09-1027B	IMPULSOR (Ancho 31 mm)	IMPELLER (Width 31 mm)	GIRANTE (Largh. 31 mm)	TURBINE (Largeur 31 mm)
		REC22120-0001	IMPULSOR (Ancho 50 mm)	IMPELLER (Width 50 mm)	GIRANTE (Largh. 50 mm)	TURBINE (Largeur 50 mm)
		REC876305	TERMOSTATO 62°	THERMOSTAT 62°	TERMOSTATO 62°	THERMOSTAT 62°
		REC978750	CORREA (Bomba alternador)	BELT (Pump alternator)	CINGHIA (Pompa altern.)	COURROIE (Pompe altern.)
		REC967111	CORREA (Dirección)	BELT (Steering)	CINGHIA (Sterzo)	COURROIE (Direction)
		NGKBR6FS	BUJÍAS	SPARK PLUG	CANDELE	BOUGIES
AQ280A		REC35-06003	FILTRO ACEITE	OIL FILTER	FILTRO OLIO	FILTRE A HUILE
AQ290A		REC982230	FILTRO COMBUSTIBLE	FUEL FILTER	FILTRO COMBUSTIBILE	FILTRE A ESSENCE
		REC3581078	FILTRO COMBUSTIBLE	FUEL FILTER	FILTRO COMBUSTIBILE	FILTRE A ESSENCE
		JOH09-1027B	IMPULSOR (Ancho 31 mm)	IMPELLER (Width 31 mm)	GIRANTE (Largh. 31 mm)	TURBINE (Largeur 31 mm)
		REC22120-0001	IMPULSOR (Ancho 50 mm)	IMPELLER (Width 50 mm)	GIRANTE (Largh. 50 mm)	TURBINE (Largeur 50 mm)
		REC876305	TERMOSTATO 62°	THERMOSTAT 62°	TERMOSTATO 62°	THERMOSTAT 62°
		REC978750	CORREA	BELT	CINGHIA	COURROIE
	AQ280A	NGKUR6	BUJÍAS	SPARK PLUGS	CANDELE	BOUGIES
	AQ290A/B	NGKBR6FS	BUJÍAS	SPARK PLUGS	CANDELE	BOUGIES



		REF				
AQ311A, B		REC35-06003	FILTRO ACEITE	OIL FILTER	FILTRO OLIO	FILTRE A HUILE
		REC855686	FILTRO COMBUSTIBLE	FUEL FILTER	FILTRO COMBUSTIBILE	FILTRE A ESSENCE
		REC3581078	FILTRO COMBUSTIBLE	FUEL FILTER	FILTRO COMBUSTIBILE	FILTRE A ESSENCE
		JOH09-1027B	IMPULSOR (Ancho 31 mm)	IMPELLER (Width 31 mm)	GIRANTE (Largh. 31 mm)	TURBINE (Largeur 31 mm)
		REC22120-0001	IMPULSOR (Ancho 50 mm)	IMPELLER (Width 50 mm)	GIRANTE (Largh. 50 mm)	TURBINE (Largeur 50 mm)
		REC876305	TERMOSTATO 62°	THERMOSTAT 62°	TERMOSTATO 62°	THERMOSTAT 62°
		REC978750	CORREA	BELT	CINGHIA	COURROIE
	NGKBR6FS	BUJÍAS	SPARK PLUGS	CANDELE	BOUGIES	
500A, B 501A, B		REC35-06003	FILTRO ACEITE	OIL FILTER	FILTRO OLIO	FILTRE A HUILE
		REC855686	FILTRO COMBUSTIBLE	FUEL FILTER	FILTRO COMBUSTIBILE	FILTRE A ESSENCE
		REC3581078	FILTRO COMBUSTIBLE	FUEL FILTER	FILTRO COMBUSTIBILE	FILTRE A ESSENCE
		JOH09-1027B	IMPULSOR (Ancho 31 mm)	IMPELLER (Width 31 mm)	GIRANTE (Largh. 31 mm)	TURBINE (Largeur 31 mm)
		REC876305	TERMOSTATO 62°	THERMOSTAT 62°	TERMOSTATO 62°	THERMOSTAT 62°
		REC978750	CORREA (Bomba alternador)	BELT (Alternator pump)	CINGHIA (Pompe alternateur)	COURROIE (Pompe alternateur)
		REC967111	CORREA (Dirección)	BELT (Steering)	CINGHIA (Sterzo)	COURROIE (Direction)
	NGKBR6FS	BUJÍAS	SPARK PLUGS	CANDELE	BOUGIES	
570A 571A 572A		REC35-06003	FILTRO ACEITE	OIL FILTER	FILTRO OLIO	FILTRE A HUILE
		REC855686	FILTRO COMBUSTIBLE	FUEL FILTER	FILTRO COMBUSTIBILE	FILTRE A ESSENCE
		JOH09-1027B	IMPULSOR (Ancho 31 mm)	IMPELLER (Width 31 mm)	GIRANTE (Largh. 31 mm)	TURBINE (Largeur 31 mm)
		CEF500104	IMPULSOR (Ancho 50 mm)	IMPELLER (Width 50 mm)	GIRANTE (Largh. 50 mm)	TURBINE (Largeur 50 mm)
		REC876305	TERMOSTATO 62°	THERMOSTAT 62°	TERMOSTATO 62°	THERMOSTAT 62°
		REC978750	CORREA (Bomba alternador)	BELT (Alternator pump)	CINGHIA (Pompe alternateur)	COURROIE (Pompe alternateur)
		REC967111	CORREA (Dirección)	BELT (Steering)	CINGHIA (Sterzo)	COURROIE (Direction)
	NGKBR6FS	BUJÍAS	SPARK PLUGS	CANDELE	BOUGIES	
740A, B		REC35-06003	FILTRO ACEITE	OIL FILTER	FILTRO OLIO	FILTRE A HUILE
		REC855686	FILTRO COMBUSTIBLE	FUEL FILTER	FILTRO COMBUSTIBILE	FILTRE A ESSENCE
		CEF500104	IMPULSOR	IMPELLER	GIRANTE	TURBINE
		REC876305	TERMOSTATO 62°	THERMOSTAT 62°	TERMOSTATO 62°	THERMOSTAT 62°
		RM967191	CORREA	BELT	CINGHIA	COURROIE
		NGKBR6FS	BUJÍAS	SPARK PLUGS	CANDELE	BOUGIES
7.4GL		RM3850559	FILTRO ACEITE	OIL FILTER	FILTRO OLIO	FILTRE A HUILE
		REC3862228	FILTRO COMBUSTIBLE	FUEL FILTER	FILTRO COMBUSTIBILE	FILTRE A ESSENCE
	MD	SHE09959K	IMPULSOR	IMPELLER	GIRANTE	TURBINE
	HU, NC, LK	JOH09-1027B	IMPULSOR	IMPELLER	GIRANTE	TURBINE
		REC3853983	TERMOSTATO	THERMOSTAT	TERMOSTATO	THERMOSTAT
		RM3850430	CORREA	BELT	CINGHIA	COURROIE
		CHARV15YC4	BUJÍAS	SPARK PLUGS	CANDELE	BOUGIES
7.4GL, GSI DPX385		RM3850559	FILTRO ACEITE	OIL FILTER	FILTRO OLIO	FILTRE A HUILE
		REC3862228	FILTRO COMBUSTIBLE	FUEL FILTER	FILTRO COMBUSTIBILE	FILTRE A ESSENCE
		JOH09-1027B	IMPULSOR	IMPELLER	GIRANTE	TURBINE
		REC3853983	TERMOSTATO	THERMOSTAT	TERMOSTATO	THERMOSTAT
	BY, WT, MD, HU, NC, LK	RM3854643	CORREA (Alternador)	BELT (Alternator)	CINGHIA (Alternatore)	COURROIE (Alternateur)
	MD, HU, NC, LK	RM3860087	CORREA (Dirección)	BELT (Steering)	CINGHIA (Sterzo)	COURROIE (Direction)
		NGKBR6FS	BUJÍAS	SPARK PLUGS	CANDELE	BOUGIES
	NGKUR6IX	BUJÍAS IRIIDIUM	SPARK PLUGS IRIIDIUM	CANDELE IRIIDIUM	BOUGIES IRIIDIUM	
8.2GL, GSI DPX415		RM3850559	FILTRO ACEITE	OIL FILTER	FILTRO OLIO	FILTRE A HUILE
		REC3862228	FILTRO COMBUSTIBLE	FUEL FILTER	FILTRO COMBUSTIBILE	FILTRE A ESSENCE
	8.2GL	SHE09959K	IMPULSOR	IMPELLER	GIRANTE	TURBINE
	GSI, DPX HU-BY, WT	JOH09-1027B	IMPULSOR	IMPELLER	GIRANTE	TURBINE
		REC3853983	TERMOSTATO	THERMOSTAT	TERMOSTATO	THERMOSTAT
		RM3852607	CORREA	BELT	CINGHIA	COURROIE
	LK, BY, WT	RM978454	CORREA (Bomba)	BELT (Pump)	CINGHIA (Pompa)	COURROIE (Pompe)
	LK, BY, WT	RM3854643	CORREA (Alternador)	BELT (Alternator)	CINGHIA (Alternatore)	COURROIE (Alternateur)
	PNCA, PNVNM	RM3850430	CORREA	BELT	CINGHIA	COURROIE
	EF	RM3860087	CORREA	BELT	CINGHIA	COURROIE
	NGKBR6FS	BUJÍAS	SPARK PLUGS	CANDELE	BOUGIES	
	NGKBR6FIX	BUJÍAS IRIIDIUM	SPARK PLUGS IRIIDIUM	CANDELE IRIIDIUM	BOUGIES IRIIDIUM	
3.0GLP-C, D, E, J		REC35-06003	FILTRO ACEITE	OIL FILTER	FILTRO OLIO	FILTRE A HUILE
		REC3847644	FILTRO COMBUSTIBLE	FUEL FILTER	FILTRO COMBUSTIBILE	FILTRE A ESSENCE
	C	JOH09-1027B	IMPULSOR	IMPELLER	GIRANTE	TURBINE
	D, E, J	JOH09-812B	IMPULSOR	IMPELLER	GIRANTE	TURBINE
		REC3853799	TERMOSTATO	THERMOSTAT	TERMOSTATO	THERMOSTAT
	C, D	RM3586325	CORREA (Alternador)	BELT (Alternator)	CINGHIA (Alternatore)	COURROIE (Alternateur)
	E	REC3860092	CORREA (Dirección)	BELT (Steering)	CINGHIA (Sterzo)	COURROIE (Direction)
	J	REC3888177	CORREA	BELT	CINGHIA	COURROIE
	NGKBPR6EFS	BUJÍAS	SPARK PLUGS	CANDELE	BOUGIES	
3.0GX1-J 3.0GXIC-J		REC35-06003	FILTRO ACEITE	OIL FILTER	FILTRO OLIO	FILTRE A HUILE
		REC3847644	FILTRO COMBUSTIBLE	FUEL FILTER	FILTRO COMBUSTIBILE	FILTRE A ESSENCE
		JOH09-812B	IMPULSOR	IMPELLER	GIRANTE	TURBINE
		REC21132392	CORREA	BELT	CINGHIA	COURROIE
		NGKBPR6EFS	BUJÍAS	SPARK PLUGS	CANDELE	BOUGIES
4.3GL-J, GL-JF 4.3GX1-J, GX1-JF 4.3OSI-J, OSI-JF	GL-J, GL-JF	REC8692305	FILTRO ACEITE	OIL FILTER	FILTRO OLIO	FILTRE A HUILE
	GL-J, GL-JF	REC3862228	FILTRO COMBUSTIBLE	FUEL FILTER	FILTRO COMBUSTIBILE	FILTRE A ESSENCE
	GXI, OSI	REC3847644	FILTRO COMBUSTIBLE	FUEL FILTER	FILTRO COMBUSTIBILE	FILTRE A ESSENCE
		JOH09-812B	IMPULSOR	IMPELLER	GIRANTE	TURBINE
		REC3587597	TERMOSTATO	THERMOSTAT	TERMOSTATO	THERMOSTAT
		REC3831426	TERMOSTATO (Agua Dulce)	THERMOSTAT (Fresh Water)	TERMOSTATO (Acqua dolce)	THERMOSTAT (Eau douce)
		REC21132390	CORREA	BELT	CINGHIA	COURROIE
		NGKBPR6EFS	BUJÍAS	SPARK PLUGS	CANDELE	BOUGIES
	NGKUR6IX	BUJÍAS IRIIDIUM	SPARK PLUGS IRIIDIUM	CANDELE IRIIDIUM	BOUGIES IRIIDIUM	

**REF**

4.3GX-I-G, GX-I-GF		REC35-06003	FILTRO ACEITE	OIL FILTER	FILTRO OLIO	FILTRE A HUILE
		REC3862228	FILTRO COMBUSTIBLE	FUEL FILTER	FILTRO COMBUSTIBILE	FILTRE A ESSENCE
4.3OSI-G, OSI-GF	GF	JOH09-812B	IMPULSOR	IMPELLER	GIRANTE	TURBINE
	G	REC3831426	TERMOSTATO	THERMOSTAT	TERMOSTATO	THERMOSTAT
		REC3587597	TERMOSTATO	THERMOSTAT	TERMOSTATO	THERMOSTAT
		RM3889124	CORREA	BELT	CINGHIA	COURROIE
		NGKBPR6EFS	BUJÍAS	SPARK PLUGS	CANDELE	BOUGIES
		NGKUR6IX	BUJÍAS IRIIDIUM	SPARK PLUGS IRIIDIUM	CANDELE IRIIDIUM	BOUGIES IRIIDIUM
5.0GL-J, GL-JF, 5.0GX-I-J, GXI-JF	GL	REC8692305	FILTRO ACEITE	OIL FILTER	FILTRO OLIO	FILTRE A HUILE
		REC3862228	FILTRO COMBUSTIBLE	FUEL FILTER	FILTRO COMBUSTIBILE	FILTRE A ESSENCE
5.0OSI-J, OSI-JF	GXI, OSI	REC3847644	FILTRO COMBUSTIBLE	FUEL FILTER	FILTRO COMBUSTIBILE	FILTRE A ESSENCE
		JOH09-812B	IMPULSOR	IMPELLER	GIRANTE	TURBINE
		REC3587597	TERMOSTATO	THERMOSTAT	TERMOSTATO	THERMOSTAT
		REC3831426	TERMOSTATO (Agua Dulce)	THERMOSTAT (Fresh Water)	TERMOSTATO (Acqua dolce)	THERMOSTAT (Eau douce)
		REC21132390	CORREA	BELT	CINGHIA	COURROIE
		NGKBPR6EFS	BUJÍAS	SPARK PLUGS	CANDELE	BOUGIES
		NGKUR6IX	BUJÍAS IRIIDIUM	SPARK PLUGS IRIIDIUM	CANDELE IRIIDIUM	BOUGIES IRIIDIUM
5.0GX-I-G, GX-I-GF		REC35-06003	FILTRO ACEITE	OIL FILTER	FILTRO OLIO	FILTRE A HUILE
		REC3862228	FILTRO COMBUSTIBLE	FUEL FILTER	FILTRO COMBUSTIBILE	FILTRE A ESSENCE
5.0OSI-G, OSI-GF		JOH09-812B	IMPULSOR	IMPELLER	GIRANTE	TURBINE
		REC3831426	TERMOSTATO	THERMOSTAT	TERMOSTATO	THERMOSTAT
		RM3889124	CORREA	BELT	CINGHIA	COURROIE
		NGKBPR6EFS	BUJÍAS	SPARK PLUGS	CANDELE	BOUGIES
		NGKUR6IX	BUJÍAS IRIIDIUM	SPARK PLUGS IRIIDIUM	CANDELE IRIIDIUM	BOUGIES IRIIDIUM
5.7GI-F, GI-FF 5.7GX-I-G, GX-I-GF		REC35-06003	FILTRO ACEITE	OIL FILTER	FILTRO OLIO	FILTRE A HUILE
		REC3862228	FILTRO COMBUSTIBLE	FUEL FILTER	FILTRO COMBUSTIBILE	FILTRE A ESSENCE
5.7OSI-E, OSI-EF		JOH09-812B	IMPULSOR	IMPELLER	GIRANTE	TURBINE
		REC3587597	TERMOSTATO	THERMOSTAT	TERMOSTATO	THERMOSTAT
		REC3831426	TERMOSTATO (Agua Dulce)	THERMOSTAT (Fresh Water)	TERMOSTATO (Acqua dolce)	THERMOSTAT (Eau douce)
		RM3889124	CORREA	BELT	CINGHIA	COURROIE
		NGKBPR6EFS	BUJÍAS	SPARK PLUGS	CANDELE	BOUGIES
		NGKUR6IX	BUJÍAS IRIIDIUM	SPARK PLUGS IRIIDIUM	CANDELE IRIIDIUM	BOUGIES IRIIDIUM
5.7GI300-J, GI300-JF		REC8692305	FILTRO ACEITE	OIL FILTER	FILTRO OLIO	FILTRE A HUILE
		REC3847644	FILTRO COMBUSTIBLE	FUEL FILTER	FILTRO COMBUSTIBILE	FILTRE A ESSENCE
5.7OSI-J, OSI-JF		JOH09-812B	IMPULSOR	IMPELLER	GIRANTE	TURBINE
5.7GX-I-J, GXI-JF		REC3587597	TERMOSTATO	THERMOSTAT	TERMOSTATO	THERMOSTAT
5.7OSXI-J, OSXI-JF		REC3831426	TERMOSTATO (Agua Dulce)	THERMOSTAT (Fresh Water)	TERMOSTATO (Acqua dolce)	THERMOSTAT (Eau douce)
		REC21132390	CORREA	BELT	CINGHIA	COURROIE
		NGKBPR6EFS	BUJÍAS	SPARK PLUGS	CANDELE	BOUGIES
		NGKUR6IX	BUJÍAS IRIIDIUM	SPARK PLUGS IRIIDIUM	CANDELE IRIIDIUM	BOUGIES IRIIDIUM
8.1GI-J, GI-JF 8.1GX-I-J, GXI-JF		REC8692305	FILTRO ACEITE	OIL FILTER	FILTRO OLIO	FILTRE A HUILE
		REC3847644	FILTRO COMBUSTIBLE	FUEL FILTER	FILTRO COMBUSTIBILE	FILTRE A ESSENCE
8.1OSI-J, OSI-JF		JOH09-812B	IMPULSOR	IMPELLER	GIRANTE	TURBINE
		REC3853983	TERMOSTATO	THERMOSTAT	TERMOSTATO	THERMOSTAT
		REC3831426	TERMOSTATO (Agua Dulce)	THERMOSTAT (Fresh Water)	TERMOSTATO (Acqua dolce)	THERMOSTAT (Eau douce)
		RM21132385	CORREA	BELT	CINGHIA	COURROIE
		NGKBPR6EFS	BUJÍAS	SPARK PLUGS	CANDELE	BOUGIES
		NGKUR6IX	BUJÍAS IRIIDIUM	SPARK PLUGS IRIIDIUM	CANDELE IRIIDIUM	BOUGIES IRIIDIUM
8.1GI-H, GI-HF 8.1GX-I-G, GX-I-GF		REC35-06003	FILTRO ACEITE	OIL FILTER	FILTRO OLIO	FILTRE A HUILE
		REC3847644	FILTRO COMBUSTIBLE	FUEL FILTER	FILTRO COMBUSTIBILE	FILTRE A ESSENCE
8.1OSI-D, OSI-DF		JOH09-812B	IMPULSOR	IMPELLER	GIRANTE	TURBINE
		REC3853983	TERMOSTATO	THERMOSTAT	TERMOSTATO	THERMOSTAT
		REC3831426	TERMOSTATO (Agua Dulce)	THERMOSTAT (Fresh Water)	TERMOSTATO (Acqua dolce)	THERMOSTAT (Eau douce)
		REC21132390	CORREA	BELT	CINGHIA	COURROIE
		NGKBPR6EFS	BUJÍAS	SPARK PLUGS	CANDELE	BOUGIES
		NGKUR6IX	BUJÍAS IRIIDIUM	SPARK PLUGS IRIIDIUM	CANDELE IRIIDIUM	BOUGIES IRIIDIUM
V6-200/240/280, V8-300/350 (Gen 5)		REC8692305	FILTRO ACEITE	OIL FILTER	FILTRO OLIO	FILTRE A HUILE
		REC3847644	FILTRO COMBUSTIBLE	FUEL FILTER	FILTRO COMBUSTIBILE	FILTRE A ESSENCE
V8-380/430 (6.2L-Gen.V)		REC21403633	ANODO COLECTOR	MANIFOLD ANODE	ANODO COLLETTORE	ANODE COLECTEUR
V8-350/380/430 (6.0L)		JOH09-1027B	IMPULSOR	IMPELLER	GIRANTE	TURBINE
V8-225/270/300/ 320 (Gen1+)		REC8692305	FILTRO ACEITE	OIL FILTER	FILTRO OLIO	FILTRE A HUILE
		REC3847644	FILTRO COMBUSTIBLE	FUEL FILTER	FILTRO COMBUSTIBILE	FILTRE A ESSENCE
		TEN02029T	ANODO INTERCAMBIADOR	EXCHANGER ANODE	ANODO SCAMBIATORE	ANODE ÉCHANGEUR
		JOH09-1027B	IMPULSOR	IMPELLER	GIRANTE	TURBINE
		NGKIZTR5B11	BUJÍAS IRIIDIUM	SPARK PLUGS IRIIDIUM	CANDELE IRIIDIUM	BOUGIES IRIIDIUM
V6-200/225 (Gen 1+)		REC8692305	FILTRO ACEITE	OIL FILTER	FILTRO OLIO	FILTRE A HUILE
		REC3847644	FILTRO COMBUSTIBLE	FUEL FILTER	FILTRO COMBUSTIBILE	FILTRE A ESSENCE
		TEN02029T	ANODO INTERCAMBIADOR	EXCHANGER ANODE	ANODO SCAMBIATORE	ANODE ÉCHANGEUR
		JOH09-812B	IMPULSOR	IMPELLER	GIRANTE	TURBINE
		NGKIZTR5B11	BUJÍAS IRIIDIUM	SPARK PLUGS IRIIDIUM	CANDELE IRIIDIUM	BOUGIES IRIIDIUM





		REF				
MD1A, B MD2A, B MD5A, B, C MD11C, D		REC834337	FILTRO ACEITE	OIL FILTRE	FILTRO OLIO	FILTRE A HUILE
	MD1/2, 5A/B, 11C	REC876554	FILTRO COMBUSTIBLE	FUEL FILTER ELEMENT	FILTRO COMBUSTIBILE	FILTRE A CARBURANT
	MD5, MD11	REC829913	FILTRO COMBUSTIBLE BLINDADO	FUEL FILTER	FILTRO COMBUSTIBILE	FILTRE A CARBURANT
		JOH09-806B	IMPULSOR (6 tornillos en tapa)	IMPELLER (6 bolt in cap)	GIRANTE (6 viti en cop- perchio)	TURBINE (6 vis en couvrerle)
		JOH09-808B	IMPULSOR (4 tornillos en tapa)	IMPELLER (4 bolt in cap)	GIRANTE (4 viti en cop- perchio)	TURBINE (4 vis en couvrerle)
	MD1B	REC875580	TERMOSTATO 75°	THERMOSTAT 75°	TERMOSTATO 75°	THERMOSTAT 75°
	MD2/11	REC876080	TERMOSTATO 60°	THERMOSTAT 60°	TERMOSTATO 60°	THERMOSTAT 60°
	MD11	REC877349	TERMOSTATO AGUA DULCE (circuito cerrado 74°)	THERMOSTAT FRESH WATER (74°)	TERMOSTATO ACQUA DOLCE (circuito chiuso 74°)	THERMOSTAT EAU DOUCE (circuit fermé 74°)
	MD5A/B/C	REC875783	TERMOSTATO 60°	THERMOSTAT (60°)	TERMOSTATO 60°	THERMOSTAT 60°
	MD1/2	REC966990	CORREA DINAMO	BELT DYNAMO	CINGHIA DINAMO	COURROIE DYNAMO
	MD1/2	REC966906	CORREA ALTERNADOR (900 mm)	BELT ALTERNATOR (900 mm)	CINGHIA ALTERNATORE (900 mm)	COURROIE ALTERNATEUR (900mm)
	MD1/2	REC3852106	CORREA ALTERNADOR (1.025 mm)	BELT ALTERNATOR (1.025 mm)	CINGHIA ALTERNATORE (1.025 mm)	COURROIE ALTERNATEUR (1.025 mm)
	MD5A/B/C	REC966990	CORREA	BELT	CINGHIA	COURROIE
	MD11C/D	REC966906	CORREA (900 mm)	BELT (900 mm)	CINGHIA (900 mm)	COURROIE (900mm)
	MD11C/D	REC966931	CORREA (1.400 mm)	BELT (1.400 mm)	CINGHIA (1.400 mm)	COURROIE (1.400 mm)
MD11C/D	REC966942	CORREA (1.550 mm con circuito cerrado)	BELT (1.550 mm fresh water)	CINGHIA (1.550 mm con circuito chiuso)	COURROIE (1.550 mm circuit fermé)	
MD6A, B		REC834337	FILTRO ACEITE	OIL FILTRE	FILTRO OLIO	FILTRE A HUILE
		REC21492771	FILTRO COMBUSTIBLE	FUEL FILTER	FILTRO COMBUSTIBILE	FILTRE A CARBURANT
		JOH09-806B	IMPULSOR (6 tornillos en tapa)	IMPELLER (6 bolt in cap)	GIRANTE (6 viti en copperchio)	TURBINE (6 vis en couvrerle)
		JOH09-808B	IMPULSOR (4 tornillos en tapa)	IMPELLER (4 bolt in cap)	GIRANTE (4 viti en copperchio)	TURBINE (4 vis en couvrerle)
		REC875796	TERMOSTATO 60°	THERMOSTAT 60°	TERMOSTATO 60°	THERMOSTAT 60°
	MD6A/B (1234+)	REC3858462	CORREA DINAMO	BELT DYNAMO	CINGHIA DINAMO	COURROIE DYNAMO
	REC966933	CORREA ALTERNADOR	BELT ALTERNATOR	CINGHIA ALTERNATORE	COURROIE ALTERNATEUR	
MD7A, B		REC834337	FILTRO ACEITE	OIL FILTRE	FILTRO OLIO	FILTRE A HUILE
		REC21492771	FILTRO COMBUSTIBLE	FUEL FILTER	FILTRO COMBUSTIBILE	FILTRE A CARBURANT
		JOH09-808B	IMPULSOR	IMPELLER	GIRANTE	TURBINE
	MD7A	REC875796	TERMOSTATO 60°	THERMOSTAT 60°	TERMOSTATO 60°	THERMOSTAT 60°
	MD7B	REC966933	CORREA	BELT	CINGHIA	COURROIE
	REC966707	CORREA	BELT	CINGHIA	COURROIE	
MD3B MD17C, D		REC834337	FILTRO ACEITE	OIL FILTRE	FILTRO OLIO	FILTRE A HUILE
		REC876554	FILTRO COMBUSTIBLE	FUEL FILTER	FILTRO COMBUSTIBILE	FILTRE A CARBURANT
	MD17	REC829913	FILTRO COMBUSTIBLE	FUEL FILTER	FILTRO COMBUSTIBILE	FILTRE A CARBURANT
		JOH09-808B	IMPULSOR	IMPELLER	GIRANTE	TURBINE
		REC876080	TERMOSTATO 60°	THERMOSTAT 60°	TERMOSTATO 60°	THERMOSTAT 60°
		REC966383	TERMOSTATO (Agua dulce circuito cerrado 74°)	THERMOSTAT (Fresh water 74°)	TERMOSTATO (acqua dolce 74° circuito chiuso)	THERMOSTAT EAU DOUCE (circuit fermé 74°)
	MD17C/D	REC966383	CORREA	BELT	CINGHIA	COURROIE
MD17C/D	GDY15545	CORREA (1.375mm Circuito cerrado)	BELT (1.375 mm Fresh water)	CINGHIA (1.375mm circuito chiuso)	COURROIE (1.5375 mm circuit fermé)	
MD21A, B AQD21A, B		REC3581621	FILTRO ACEITE	OIL FILTER	FILTRO OLIO	FILTRE A HUILE
		REC3581078	FILTRO COMBUSTIBLE	FUEL FILTER	FILTRO COMBUSTIBILE	FILTRE A CARBURANT
		JOH09-801B	IMPULSOR	IMPELLER	GIRANTE	TURBINE
		REC875785	TERMOSTATO	THERMOSTAT	TERMOSTATO	THERMOSTAT
		REC829207	CORREA	BELT	CINGHIA	COURROIE
MD22A, B TMD22A, B TAMD22A	A	REC861476	FILTRO ACEITE	OIL FILTER	FILTRO OLIO	FILTRE A HUILE
	B, C	REC3517857	FILTRO ACEITE	OIL FILTER	FILTRO OLIO	FILTRE A HUILE
		REC3840335	FILTRO COMBUSTIBLE	FUEL FILTER	FILTRO COMBUSTIBILE	FILTRE A CARBURANT
		JOH09-1027B	IMPULSOR	IMPELLER	GIRANTE	TURBINE
		RM6210419	TERMOSTATO	THERMOSTAT	TERMOSTATO	THERMOSTAT
		RM966912	CORREA	BELT	CINGHIA	COURROIE
MD30A, B, D AQ30A, B, D TAMD30A, B, D TMD30A, B, D		REC3517857	FILTRO ACEITE	OIL FILTER	FILTRO OLIO	FILTRE A HUILE
		REC21492771	FILTRO COMBUSTIBLE	FUEL FILTER	FILTRO COMBUSTIBILE	FILTRE A CARBURANT
		REC876185	FILTRO AIRE	AIR FILTER	FILTRO ARIA	FILTRE A AIR
		REC876069	FILTRO CÁRTER	CÁRTER FILTER	FILTRO CÁRTER	FILTRE RENIFLARD
		REC838929	ÁNODO MOTOR	ENGINE ANODE	ANODO MOTORE	ANODE MOTEUR
		JOH09-1028B	IMPULSOR	IMPELLER	GIRANTE	TURBINE
		REC3831425	TERMOSTATO	THERMOSTAT	TERMOSTATO	THERMOSTAT
		REC966978	CORREA (1.100 mm)	BELT (1.100 mm)	CINGHIA (1.100 mm)	COURROIE (1.100 mm)
		REC3517857	FILTRO ACEITE	OIL FILTER	FILTRO OLIO	FILTRE A HUILE
		REC21492771	FILTRO COMBUSTIBLE	FUEL FILTER	FILTRO COMBUSTIBILE	FILTRE A CARBURANT
AQAD31, A AD31A, B, D, XD, P, L-A MD31, A TMD31A, B, D, L-A TAMD31A, B, D, P, L, M, S-A KAD32A		REC858488	FILTRO AIRE (Metal)	AIR FILTER (Metal.)	FILTRO ARIA (Metal.)	FILTRE A AIR (Métal.)
		REC21646645	FILTRO AIRE (Plast.)	AIR FILTER (Plast.)	FILTRO ARIA (Plast.)	FILTRE A AIR (Plast.)
		REC876069	FILTRO CÁRTER	CÁRTER FILTER	FILTRO CÁRTER	FILTRE RENIFLARD
		REC838929	ÁNODO MOTOR	ENGINE ANODE	ANODO MOTORE	ANODE MOTEUR
		JOH09-1028B	IMPULSOR	IMPELLER	GIRANTE	TURBINE
		REC3831426	TERMOSTATO 70°	THERMOSTAT 70°	TERMOSTATO 70°	THERMOSTAT 70°
		REC3831424	TERMOSTATO 81°	THERMOSTAT 81°	TERMOSTATO 81°	THERMOSTAT 81°
		RM3581460	CORREA COMPRESOR	COMPRESOR BELT	CINGHIA COMPRESSORE	COURROIE COMPRESSEUR
		REC861564	CORREA BOMBA	BELT PUMP	CINGHIA PUMPA	COURROIE POMPE
		REC977542	CORREA ALTERNADOR	BELT ALTERNATOR	CINGHIA ALTERNATORE	COURROIE ALTERNATEUR
	REC966978	CORREA (1.100 mm)	BELT (1.100 mm)	CINGHIA (1.100 mm)	COURROIE (1.100 mm)	



		REF					
MD40A TMD40A, B, C TAMD40A B AQD40A AQAD40A, B		REC471034	FILTRO ACEITE	OIL FILTER	FILTRO OLIO	FILTRE A HUILE	
		REC3840335	FILTRO COMBUSTIBLE	FUEL FILTER	FILTRO COMBUSTIBILE	FILTRE A CARBURANT	
		REC876185	FILTRO AIRE	AIR FILTER	FILTRO ARIA	FILTRE A AIR	
		REC876069	FILTRO CÁRTER	CÁRTER FILTER	FILTRO CÁRTER	FILTRE RENIFLARD	
		REC838929	ÁNODO MOTOR	ENGINE ANODE	ANODO MOTORE	ANODE MOTEUR	
		JOH09-1028B	IMPULSOR	IMPELLER	GIRANTE	TURBINE	
		JOH09-1029B	IMPULSOR	IMPELLER	GIRANTE	TURBINE	
	TAMD40, AD40	antiguo   old vecchio   ancien moderno   new moderno   moderne	REC3831426	TERMOSTATO 70°	THERMOSTAT 70°	TERMOSTATO 70°	THERMOSTAT 70°
			REC3831424	TERMOSTATO 81°	THERMOSTAT 81°	TERMOSTATO 81°	THERMOSTAT 81°
			REC966978	CORREA (1.100 mm)	BELT (1.100 mm)	CINGHIA (1.100 mm)	COURROIE (1.100 mm)
TMD41A, B, D, L-A TAMD41A, B, D D41A, B, D, L-A AD41A, B, D AQD41A AQAD41A		REC471034	FILTRO ACEITE	OIL FILTER	FILTRO OLIO	FILTRE A HUILE	
		REC3840335	FILTRO COMBUSTIBLE	FUEL FILTER	FILTRO COMBUSTIBILE	FILTRE A CARBURANT	
		REC858488	FILTRO AIRE (Ø200 mm)	AIR FILTER (Ø 200mm)	FILTRO ARIA (Ø 200mm)	FILTRE A AIR (Ø 200 mm)	
		REC21646645	FILTRO AIRE (Ø165mm)	AIR FILTER (Ø 165mm)	FILTRO ARIA (Ø 165mm)	FILTRE A AIR (Ø 165 mm)	
		REC876069	FILTRO CÁRTER	CÁRTER FILTER	FILTRO CÁRTER	FILTRE RENIFLARD	
		REC838929	ÁNODO MOTOR	ENGINE ANODE	ANODO MOTORE	ANODE MOTEUR	
		JOH09-1028B	IMPULSOR	IMPELLER	GIRANTE	TURBINE	
		REC3831426	TERMOSTATO 70°	THERMOSTAT 70°	TERMOSTATO 70°	THERMOSTAT 70°	
		REC3831424	TERMOSTATO 81°	THERMOSTAT 81°	TERMOSTATO 81°	THERMOSTAT 81°	
		REC966978	CORREA (1.100 mm)	BELT (1.100 mm)	CINGHIA (1.100 mm)	COURROIE (1.100 mm)	
TAMD41P, L, M, H-A, H-B AD41P, L-A KAD42A, B, P-A KAMD42A, B, P-A KAD43P-A KAMD43P-A	41	REC471034	FILTRO ACEITE	OIL FILTER	FILTRO OLIO	FILTRE A HUILE	
	42, 43	REC127695-35150	FILTRO ACEITE	OIL FILTER	FILTRO OLIO	FILTRE A HUILE	
		REC3840335	FILTRO COMBUSTIBLE	FUEL FILTER	FILTRO COMBUSTIBILE	FILTRE A CARBURANT	
	41	REC858488	FILTRO AIRE (Ø 200 mm)	AIR FILTER (Ø 200 mm)	FILTRO ARIA (Ø 200 mm)	FILTRE A AIR (Ø 200 mm)	
	antiguo   old vecchio   ancien moderno   new moderno   moderne	REC21646645	FILTRO AIRE (Ø 165 mm)	AIR FILTER (Ø 165 mm)	FILTRO ARIA (Ø 165 mm)	FILTRE A AIR (Ø 165 mm)	
		REC876185	FILTRO AIRE	AIR FILTER	FILTRO ARIA	FILTRE A AIR	
		REC876069	FILTRO CÁRTER	CÁRTER FILTER	FILTRO CÁRTER	FILTRE RENIFLARD	
		REC838929	ÁNODO MOTOR	ENGINE ANODE	ANODO MOTORE	ANODE MOTEUR	
		JOH09-1028B	IMPULSOR	IMPELLER	GIRANTE	TURBINE	
	moderno   new moderno   moderne	REC3831424	TERMOSTATO 81°	THERMOSTAT 81°	TERMOSTATO 81°	THERMOSTAT 81°	
KAD42A/B, KAM- D42A/B/P-A KAD43P-A, KAMD43P-A KAD42A/B, KAMD42A/B KAD42, KAMD42, KAD43, KAMD43		REC860388	CORREA COMP.	BELT COMP.	CINGHIA COMP.	COURROIE COMP.	
		REC860388	CORREA COMP.	BELT COMP.	CINGHIA COMP.	COURROIE COMP.	
		REC976483	CORREA BOMBA	BELT PUMP	CINGHIA PUMP	COURROIE POMPE	
		REC977542	CORREA ALTERNADOR	BELT ALTERNATOR	CINGHIA ALTERNATORE	COURROIE ALTERNATEUR	
		REC127695-35150	FILTRO ACEITE	OIL FILTER	FILTRO OLIO	FILTRE A HUILE	
		REC3840335	FILTRO COMBUSTIBLE	FUEL FILTER	FILTRO COMBUSTIBILE	FILTRE A CARBURANT	
		REC876185	FILTRO AIRE	AIR FILTER	FILTRO ARIA	FILTRE A AIR	
		REC876069	FILTRO CÁRTER	CÁRTER FILTER	FILTRO CÁRTER	FILTRE RENIFLARD	
		JOH09-1028B	IMPULSOR	IMPELLER	GIRANTE	TURBINE	
	moderno   new moderno   moderne	REC3831424	TERMOSTATO 81°	THERMOSTAT 81°	TERMOSTATO 81°	THERMOSTAT 81°	
KAD44P-A, P, B, P-C KAMD44P-A, P-B, P-C KAD300A KAMD300A		REC860388	CORREA COMP.	BELT COMP.	CINGHIA COMP.	COURROIE COMP.	
		REC860388	CORREA COMP.	BELT COMP.	CINGHIA COMP.	COURROIE COMP.	
		REC861564	CORREA BOMBA	BELT PUMP	CINGHIA PUMP	COURROIE POMPE	
		REC977542	CORREA ALTERNADOR	BELT ALTERNATOR	CINGHIA ALTERNATORE	COURROIE ALTERNATEUR	
		REC127695-35150	FILTRO ACEITE	OIL FILTER	FILTRO OLIO	FILTRE A HUILE	
		REC21492771	FILTRO COMBUSTIBLE	FUEL FILTER	FILTRO COMBUSTIBILE	FILTRE A CARBURANT	
		REC842280	FILTRO AIRE	AIR FILTER	FILTRO ARIA	FILTRE A AIR	
		REC876069	FILTRO CÁRTER	CÁRTER FILTER	FILTRO CÁRTER	FILTRE RENIFLARD	
		JOH09-1028B	IMPULSOR	IMPELLER	GIRANTE	TURBINE	
		REC3831426	TERMOSTATO 70°	THERMOSTAT 70°	TERMOSTATO 70°	THERMOSTAT 70°	
TAMD60A, B, C		REC3831425	TERMOSTATO 76°	THERMOSTAT 76°	TERMOSTATO 76°	THERMOSTAT 76°	
		REC966906	CORREA ALTERNADOR	BELT ALTERNATOR	CINGHIA ALTERNATORE	COURROIE ALTERNATEUR	
		RM966391	CORREA BOMBA	BELT PUMP	CINGHIA POMPA	COURROIE POMPE	
	TAMD61A TAMD62A		REC847741	FILTRO ACEITE	OIL FILTER	FILTRO OLIO	FILTRE A HUILE
			REC3827069	FILTRO ACEITE BY-PASS	OIL FILTER BY-PASS	FILTRO OLIO BY-PASS	FILTRE A HUILE BY-PASS
			REC21492771	FILTRO COMBUSTIBLE	FUEL FILTER	FILTRO COMBUSTIBILE	FILTRE A CARBURANT
			REC876185	FILTRO AIRE	AIR FILTER	FILTRO ARIA	FILTRE A AIR
			REC876069	FILTRO CÁRTER	CÁRTER FILTER	FILTRO CÁRTER	FILTRE RENIFLARD
			JOH09-819B	IMPULSOR	IMPELLER	GIRANTE	TURBINE
			REC3839110	TERMOSTATO 75°	THERMOSTAT 75°	TERMOSTATO 75°	THERMOSTAT 75°
TAMD61A/B, TAMD62A			RM967193	CORREA ALTERNADOR	BELT ALTERNATOR	CINGHIA ALTERNATORE	COURROIE ALTERNATEUR
TAMD63P-A-L			REC847741	FILTRO ACEITE	OIL FILTER	FILTRO OLIO	FILTRE A HUILE
			REC3827069	FILTRO ACEITE BY-PASS	OIL FILTER BY-PASS	FILTRO OLIO BY-PASS	FILTRE A HUILE BY-PASS
		REC21492771	FILTRO COMBUSTIBLE	FUEL FILTER	FILTRO COMBUSTIBILE	FILTRE A CARBURANT	
		REC3825038	FILTRO AIRE	AIR FILTER	FILTRO ARIA	FILTRE A AIR	
		REC876069	FILTRO CÁRTER	CÁRTER FILTER	FILTRO CÁRTER	FILTRE RENIFLARD	
		JOH09-821B	IMPULSOR	IMPELLER	GIRANTE	TURBINE	
		REC3839110	TERMOSTATO 75°	THERMOSTAT 75°	TERMOSTATO 75°	THERMOSTAT 75°	
		REC866653	CORREA	BELT	CINGHIA	COURROIE	



	REF				
MD70B TMD70B	REC127695-35150	FILTRO ACEITE	OIL FILTER	FILTRO OLIO	FILTRE A HUILE
	REC21492771	FILTRO COMBUSTIBLE	FUEL FILTER	FILTRO COMBUSTIBILE	FILTRE A CARBURANT
	REC842280	FILTRO AIRE	AIR FILTER	FILTRO ARIA	FILTRE A AIR
	REC876069	FILTRO CÁRTER	CÁRTER FILTER	FILTRO CÁRTER	FILTRE RENIFLARD
	JOH09-1028B	IMPULSOR	IMPELLER	GIRANTE	TURBINE
	REC875785	TERMOSTATO 70°	THERMOSTAT 70°	TERMOSTATO 70°	THERMOSTAT 70°
	REC3831425	TERMOSTATO 76°	THERMOSTAT 76°	TERMOSTATO 76°	THERMOSTAT 76°
MD70C TMD70C	REC127695-35150	FILTRO ACEITE	OIL FILTER	FILTRO OLIO	FILTRE A HUILE
	REC21492771	FILTRO COMBUSTIBLE	FUEL FILTER	FILTRO COMBUSTIBILE	FILTRE A CARBURANT
	REC842280	FILTRO AIRE	AIR FILTER	FILTRO ARIA	FILTRE A AIR
	REC876069	FILTRO CÁRTER	CÁRTER FILTER	FILTRO CÁRTER	FILTRE RENIFLARD
	JOH09-1028B	IMPULSOR	IMPELLER	GIRANTE	TURBINE
	REC875785	TERMOSTATO 70°	THERMOSTAT 70°	TERMOSTATO 70°	THERMOSTAT 70°
	REC3831425	TERMOSTATO 76°	THERMOSTAT 76°	TERMOSTATO 76°	THERMOSTAT 76°
TAMD70B, C	REC471034	FILTRO ACEITE	OIL FILTER	FILTRO OLIO	FILTRE A HUILE
	REC21492771	FILTRO COMBUSTIBLE	FUEL FILTER	FILTRO COMBUSTIBILE	FILTRE A CARBURANT
	REC842280	FILTRO AIRE	AIR FILTER	FILTRO ARIA	FILTRE A AIR
	REC876069	FILTRO CÁRTER	CÁRTER FILTER	FILTRO CÁRTER	FILTRE RENIFLARD
	JOH09-1028B	IMPULSOR	IMPELLER	GIRANTE	TURBINE
	REC875785	TERMOSTATO 70°	THERMOSTAT 70°	TERMOSTATO 70°	THERMOSTAT 70°
	REC3831425	TERMOSTATO 76°	THERMOSTAT 76°	TERMOSTATO 76°	THERMOSTAT 76°
TAMD70D, E AQAD70B	REC471034	FILTRO ACEITE	OIL FILTER	FILTRO OLIO	FILTRE A HUILE
	REC21492771	FILTRO COMBUSTIBLE	FUEL FILTER	FILTRO COMBUSTIBILE	FILTRE A CARBURANT
	REC842280	FILTRO AIRE	AIR FILTER	FILTRO ARIA	FILTRE A AIR
	REC876069	FILTRO CÁRTER	CÁRTER FILTER	FILTRO CÁRTER	FILTRE RENIFLARD
	JOH09-1028B	IMPULSOR	IMPELLER	GIRANTE	TURBINE
	REC875785	TERMOSTATO 70°	THERMOSTAT 70°	TERMOSTATO 70°	THERMOSTAT 70°
	REC3831425	TERMOSTATO 76°	THERMOSTAT 76°	TERMOSTATO 76°	THERMOSTAT 76°
AQD70C, D	REC127695-35150	FILTRO ACEITE	OIL FILTER	FILTRO OLIO	FILTRE A HUILE
	REC21492771	FILTRO COMBUSTIBLE	FUEL FILTER	FILTRO COMBUSTIBILE	FILTRE A CARBURANT
	REC842280	FILTRO AIRE	AIR FILTER	FILTRO ARIA	FILTRE A AIR
	REC876069	FILTRO CÁRTER	CÁRTER FILTER	FILTRO CÁRTER	FILTRE RENIFLARD
	JOH09-1028B	IMPULSOR	IMPELLER	GIRANTE	TURBINE
	REC875785	TERMOSTATO 70°	THERMOSTAT 70°	TERMOSTATO 70°	THERMOSTAT 70°
	REC3831425	TERMOSTATO 76°	THERMOSTAT 76°	TERMOSTATO 76°	THERMOSTAT 76°
TAMD71A, B TAMD72A, P-A	REC847741	FILTRO ACEITE	OIL FILTER	FILTRO OLIO	FILTRE A HUILE
	REC3827069	FILTRO ACEITE BY-PASS	OIL FILTER BY-PASS	FILTRO OLIO BY-PASS	FILTRE A HUILE BY-PASS
	REC21492771	FILTRO COMBUSTIBLE	FUEL FILTER	FILTRO COMBUSTIBILE	FILTRE A CARBURANT
	REC876185	FILTRO AIRE	AIR FILTER	FILTRO ARIA	FILTRE A AIR
	REC876069	FILTRO CÁRTER	CÁRTER FILTER	FILTRO CÁRTER	FILTRE RENIFLARD
	JOH09-819B	IMPULSOR	IMPELLER	GIRANTE	TURBINE
	REC3839110	TERMOSTATO	THERMOSTAT	TERMOSTATO	THERMOSTAT
TAMD73A, P-A, W, TAMD74P-	REC847741	FILTRO ACEITE	OIL FILTER	FILTRO OLIO	FILTRE A HUILE
	REC3827069	FILTRO ACEITE BY-PASS	OIL FILTER BY-PASS	FILTRO OLIO BY-PASS	FILTRE A HUILE BY-PASS
	REC21492771	FILTRO COMBUSTIBLE	FUEL FILTER	FILTRO COMBUSTIBILE	FILTRE A CARBURANT
	RM3838952	FILTRO AIRE	AIR FILTER	FILTRO ARIA	FILTRE A AIR
	REC876069	FILTRO CÁRTER	CÁRTER FILTER	FILTRO CÁRTER	FILTRE RENIFLARD
	JOH09-819B	IMPULSOR	IMPELLER	GIRANTE	TURBINE
	REC875785	TERMOSTATO 70°	THERMOSTAT 70°	TERMOSTATO 70°	THERMOSTAT 70°
MD100A, B TMD100A	REC3831425	TERMOSTATO 76°	THERMOSTAT 76°	TERMOSTATO 76°	THERMOSTAT 76°
	REC57-36356	CORREA ALTERNADOR	BELT ALTERNATOR	CINGHIA ALTERNATORE	COURROIE ALTERNATEUR
	GDY15335	CORREA BOMBA	BELT PUMP	CINGHIA POMPA	COURROIE POMPE
	REC127695-35150	FILTRO ACEITE	OIL FILTER	FILTRO OLIO	FILTRE A HUILE
	REC21492771	FILTRO COMBUSTIBLE	FUEL FILTER	FILTRO COMBUSTIBILE	FILTRE A CARBURANT
	REC842280	FILTRO AIRE	AIR FILTER	FILTRO ARIA	FILTRE A AIR
	REC876069	FILTRO CÁRTER	CÁRTER FILTER	FILTRO CÁRTER	FILTRE RENIFLARD
TMD100C TMD102A	JOH09-819B	IMPULSOR	IMPELLER	GIRANTE	TURBINE
	REC875785	TERMOSTATO 70°	THERMOSTAT 70°	TERMOSTATO 70°	THERMOSTAT 70°
	REC3831425	TERMOSTATO 76°	THERMOSTAT 76°	TERMOSTATO 76°	THERMOSTAT 76°
	REC21707134	FILTRO ACEITE	OIL FILTER	FILTRO OLIO	FILTRE A HUILE
	REC21492771	FILTRO COMBUSTIBLE	FUEL FILTER	FILTRO COMBUSTIBILE	FILTRE A CARBURANT
	REC842280	FILTRO AIRE	AIR FILTER	FILTRO ARIA	FILTRE A AIR
	REC876069	FILTRO CÁRTER	CÁRTER FILTER	FILTRO CÁRTER	FILTRE RENIFLARD
	GDY15335	CORREA BOMBA	BELT PUMP	CINGHIA POMPA	COURROIE POMPE



	REF					
TAMD102A-D TAMD103A	REC21707134	FILTRO ACEITE	OIL FILTER	FILTRO OLIO	FILTRE A HUILE	
	REC21492771	FILTRO COMBUSTIBLE	FUEL FILTER	FILTRO COMBUSTIBILE	FILTRE A CARBURANT	
	REC876069	FILTRO CÁRTER	CÁRTER FILTER	FILTRO CÁRTER	FILTRE RENIFLARD	
	JOH09-819B	IMPULSOR	IMPELLER	GIRANTE	TURBINE	
	REC875785	TERMOSTATO 70°	THERMOSTAT 70°	TERMOSTATO 70°	THERMOSTAT 70°	
	REC3831425	TERMOSTATO 76°	THERMOSTAT 76°	TERMOSTATO 76°	THERMOSTAT 76°	
	GDY15386	CORREA ALTERNADOR	BELT ALTERNATOR	CINGHIA ALTERNATORE	COURROIE ALTERNATEUR	
MD120A TMD120A TAMD120A	REC127695-35150	FILTRO ACEITE	OIL FILTER	FILTRO OLIO	FILTRE A HUILE	
	REC21492771	FILTRO COMBUSTIBLE	FUEL FILTER	FILTRO COMBUSTIBILE	FILTRE A CARBURANT	
	REC842280	FILTRO AIRE	AIR FILTER	FILTRO ARIA	FILTRE A AIR	
	REC876069	FILTRO CÁRTER	CÁRTER FILTER	FILTRO CÁRTER	FILTRE RENIFLARD	
	JOH09-819B	IMPULSOR	IMPELLER	GIRANTE	TURBINE	
	REC875785	TERMOSTATO 70°	THERMOSTAT 70°	TERMOSTATO 70°	THERMOSTAT 70°	
	REC3831425	TERMOSTATO 76°	THERMOSTAT 76°	TERMOSTATO 76°	THERMOSTAT 76°	
TMD120B	GDY15386	CORREA ALTERNADOR	BELT ALTERNATOR	CINGHIA ALTERNATORE	COURROIE ALTERNATEUR	
	REC21707134	FILTRO ACEITE	OIL FILTER	FILTRO OLIO	FILTRE A HUILE	
	REC21492771	FILTRO COMBUSTIBLE	FUEL FILTER	FILTRO COMBUSTIBILE	FILTRE A CARBURANT	
	REC842280	FILTRO AIRE	AIR FILTER	FILTRO ARIA	FILTRE A AIR	
	REC876069	FILTRO CÁRTER	CÁRTER FILTER	FILTRO CÁRTER	FILTRE RENIFLARD	
	REC875785	TERMOSTATO 70°	THERMOSTAT 70°	TERMOSTATO 70°	THERMOSTAT 70°	
	REC3831425	TERMOSTATO 76°	THERMOSTAT 76°	TERMOSTATO 76°	THERMOSTAT 76°	
TAMD120B	GDY15386	CORREA ALTERNADOR	BELT ALTERNATOR	CINGHIA ALTERNATORE	COURROIE ALTERNATEUR	
	REC21707134	FILTRO ACEITE	OIL FILTER	FILTRO OLIO	FILTRE A HUILE	
	REC21492771	FILTRO COMBUSTIBLE	FUEL FILTER	FILTRO COMBUSTIBILE	FILTRE A CARBURANT	
	REC842280	FILTRO AIRE	AIR FILTER	FILTRO ARIA	FILTRE A AIR	
	REC876069	FILTRO CÁRTER	CÁRTER FILTER	FILTRO CÁRTER	FILTRE RENIFLARD	
	JOH09-819B	IMPULSOR	IMPELLER	GIRANTE	TURBINE	
	REC875785	TERMOSTATO 70°	THERMOSTAT 70°	TERMOSTATO 70°	THERMOSTAT 70°	
TMD121C	REC3831425	TERMOSTATO 76°	THERMOSTAT 76°	TERMOSTATO 76°	THERMOSTAT 76°	
	GDY15386	CORREA ALTERNADOR	BELT ALTERNATOR	CINGHIA ALTERNATORE	COURROIE ALTERNATEUR	
	REC21707134	FILTRO ACEITE	OIL FILTER	FILTRO OLIO	FILTRE A HUILE	
	REC21492771	FILTRO COMBUSTIBLE	FUEL FILTER	FILTRO COMBUSTIBILE	FILTRE A CARBURANT	
	REC842280	FILTRO AIRE	AIR FILTER	FILTRO ARIA	FILTRE A AIR	
	REC876069	FILTRO CÁRTER	CÁRTER FILTER	FILTRO CÁRTER	FILTRE RENIFLARD	
	JOH09-819B	IMPULSOR	IMPELLER	GIRANTE	TURBINE	
TAMD121C-D TMD122A TAMD122A-F TAMD122C	REC875785	TERMOSTATO 70°	THERMOSTAT 70°	TERMOSTATO 70°	THERMOSTAT 70°	
	REC3831425	TERMOSTATO 76°	THERMOSTAT 76°	TERMOSTATO 76°	THERMOSTAT 76°	
	GDY15386	CORREA ALTERNADOR	BELT ALTERNATOR	CINGHIA ALTERNATORE	COURROIE ALTERNATEUR	
	REC21707134	FILTRO ACEITE	OIL FILTER	FILTRO OLIO	FILTRE A HUILE	
	REC21492771	FILTRO COMBUSTIBLE	FUEL FILTER	FILTRO COMBUSTIBILE	FILTRE A CARBURANT	
	REC842280	FILTRO AIRE	AIR FILTER	FILTRO ARIA	FILTRE A AIR	
	REC876069	FILTRO CÁRTER	CÁRTER FILTER	FILTRO CÁRTER	FILTRE RENIFLARD	
TAMD122P-A, D	REC875785	TERMOSTATO 70°	THERMOSTAT 70°	TERMOSTATO 70°	THERMOSTAT 70°	
	REC3831425	TERMOSTATO 76°	THERMOSTAT 76°	TERMOSTATO 76°	THERMOSTAT 76°	
	GDY15386	CORREA ALTERNADOR	BELT ALTERNATOR	CINGHIA ALTERNATORE	COURROIE ALTERNATEUR	
	REC847741	FILTRO ACEITE	OIL FILTER	FILTRO OLIO	FILTRE A HUILE	
	REC21492771	FILTRO COMBUSTIBLE	FUEL FILTER	FILTRO COMBUSTIBILE	FILTRE A CARBURANT	
	REC842280	FILTRO AIRE	AIR FILTER	FILTRO ARIA	FILTRE A AIR	
	REC876069	FILTRO CÁRTER	CÁRTER FILTER	FILTRO CÁRTER	FILTRE RENIFLARD	
2001, 2022, 2003, 2003T	GDY15386	CORREA ALTERNADOR	BELT ALTERNATOR	CINGHIA ALTERNATORE	COURROIE ALTERNATEUR	
	REC834337	FILTRO ACEITE	OIL FILTER	FILTRO OLIO	FILTRE A HUILE	
	REC829913	FILTRO COMBUSTIBLE	FUEL FILTER	FILTRO COMBUSTIBILE	FILTRE A CARBURANT	
	REC838929	ÁNODO MOTOR	ENGINE ANODE	ANODO MOTORE	ANODE MOTEUR	
	2001, 2002, 2003 2003T	JOH09-808B	IMPULSOR	IMPELLER	GIRANTE	TURBINE
	JOH09-1027B	IMPULSOR	IMPELLER	GIRANTE	TURBINE	
	REC877355	TERMOSTATO 62°	THERMOSTAT 70°	TERMOSTATO 70°	THERMOSTAT 70°	
	RM875795	TERMOSTATO (74° circuito cerrado)	THERMOSTAT (74° fresh water)	TERMOSTATO (74° con circuito chiuso)	THERMOSTAT 74° (circuit fermé)	
	2001	REC966903	CORREA	BELT	CINGHIA	COURROIE
	2002, 2003 2003T	REC966900	CORREA	BELT	CINGHIA	COURROIE
MD2010 MD2020 MD2030 MD2040	REC966906	CORREA	BELT	CINGHIA	COURROIE	
	2010, 2020	REC861473	FILTRO ACEITE	OIL FILTER	FILTRO OLIO	FILTRE A HUILE
	2030, 2040	RM3840525	FILTRO ACEITE	OIL FILTER	FILTRO OLIO	FILTRE A HUILE
	REC861477	FILTRO COMBUSTIBLE	FUEL FILTER	FILTRO COMBUSTIBILE	FILTRE A CARBURANT	
	2020, 2030, 2040	REC3580509	FILTRO AIRE	AIR FILTER	FILTRO ARIA	FILTRE A AIR
	MD2010 (-5101203008), MD2020 (-5101309052)	JOH09-806B	IMPULSOR	IMPELLER	GIRANTE	TURBINE
	MD2010 (5101203009+)	JOH09-1026B	IMPULSOR	IMPELLER	GIRANTE	TURBINE
	MD2020 (5101309053+), MD2030/2040	JOH09-1026B	IMPULSOR	IMPELLER	GIRANTE	TURBINE
	2010, 2020	RM861911	TERMOSTATO	THERMOSTAT	TERMOSTATO	THERMOSTAT
	2030, 2040	RM3580365	TERMOSTATO	THERMOSTAT	TERMOSTATO	THERMOSTAT
	MD2010A/B/C, MD2020A/B/C	RM973534	CORREA	BELT	CINGHIA	COURROIE
	MD2030A/B/C	REC978482	CORREA	BELT	CINGHIA	COURROIE
	MD2040A/B/C	RM967114	CORREA	BELT	CINGHIA	COURROIE





		REF					
D1-13 D1-20		REC861473	FILTRO ACEITE	OIL FILTER	FILTRO OLIO	FILTRE A HUILE	
		REC861477	FILTRO COMBUSTIBLE	FUEL FILTER	FILTRO COMBUSTIBILE	FILTRE A CARBURANT	
		JOH09-1026B	IMPULSOR	IMPELLER	GIRANTE	TURBINE	
		RM3842015	TERMOSTATO	THERMOSTAT	TERMOSTATO	THERMOSTAT	
		RM3809625	CORREA	BELT	CINGHIA	COURROIE	
D1-30 D2-40		REC3840525	FILTRO ACEITE	OIL FILTER	FILTRO OLIO	FILTRE A HUILE	
		REC861477	FILTRO COMBUSTIBLE	FUEL FILTER	FILTRO COMBUSTIBILE	FILTRE A CARBURANT	
		JOH09-1026B	IMPULSOR	IMPELLER	GIRANTE	TURBINE	
		RM3842015	TERMOSTATO	THERMOSTAT	TERMOSTATO	THERMOSTAT	
	D1-30		RM3812159	CORREA	BELT	CINGHIA	COURROIE
	D2-40		RM21314684	CORREA	BELT	CINGHIA	COURROIE
D2-50 D2-55 D2-60 D2-75		REC3840525	FILTRO ACEITE	OIL FILTER	FILTRO OLIO	FILTRE A HUILE	
		REC861477	FILTRO COMBUSTIBLE	FUEL FILTER	FILTRO COMBUSTIBILE	FILTRE A CARBURANT	
		REC3580509	FILTRO AIRE	AIR FILTER	FILTRO ARIA	FILTRE A AIR	
		JOH09-1027B	IMPULSOR	IMPELLER	GIRANTE	TURBINE	
		RM888624	TERMOSTATO	THERMOSTAT	TERMOSTATO	THERMOSTAT	
	D2-55		RM967114	CORREA	BELT	CINGHIA	COURROIE
	D2-75		RM3584086	CORREA	BELT	CINGHIA	COURROIE
D3, (-MY2009)		REC8692305	FILTRO ACEITE	OIL FILTER	FILTRO OLIO	FILTRE A HUILE	
		RM31261191	FILTRO COMBUSTIBLE	FUEL FILTER	FILTRO COMBUSTIBILE	FILTRE A CARBURANT	
		REC21646645	FILTRO AIRE Redondo	AIR FILTER Round	FILTRO ARIA Rotondo	FILTRE A AIR rond	
		REC21171277	FILTRO AIRE Cuadrado	AIR FILTER Square	FILTRO ARIA Quadrato	FILTRE A AIR carré	
		CEF500178G	IMPULSOR	IMPELLER	GIRANTE	TURBINE	
		REC3840816	TERMOSTATO	THERMOSTAT	TERMOSTATO	THERMOSTAT	
		REC30731809	CORREA	BELT	CINGHIA	COURROIE	
D3, (MY2010+)		REC30788490	FILTRO ACEITE	OIL FILTER	FILTRO OLIO	FILTRE A HUILE	
		RM21139810	FILTRO COMBUSTIBLE	FUEL FILTER	FILTRO COMBUSTIBILE	FILTRE A CARBURANT	
		REC21379288	FILTRO AIRE	AIR FILTER	FILTRO ARIA	FILTRE A AIR	
		CEF500178G	IMPULSOR	IMPELLER	GIRANTE	TURBINE	
		REC3840816	TERMOSTATO	THERMOSTAT	TERMOSTATO	THERMOSTAT	
		REC30731809	CORREA	BELT	CINGHIA	COURROIE	
D4 D6		REC3582732	FILTRO ACEITE	OIL FILTER	FILTRO OLIO	FILTRE A HUILE	
		REC21632901	FILTRO ACEITE BY-PASS	OIL FILTER BY-PASS	FILTRO OLIO BY-PASS	FILTRE A HUILE BY-PASS	
	-MY2019	REC3583443	FILTRO COMBUSTIBLE	FUEL FILTER	FILTRO COMBUSTIBILE	FILTRE A CARBURANT	
	MY2020+	RM23954708	FILTRO COMBUSTIBLE	FUEL FILTER	FILTRO COMBUSTIBILE	FILTRE A CARBURANT	
		REC3584145	FILTRO CÁRTER	CÁRTER FILTER	FILTRO CÁRTER	FILTRE CARTER	
		REC21702999	FILTRO AIRE	AIR FILTER	FILTRO ARIA	FILTRE À AIR	
	SN407905	REC838929	ÁNODO MOTOR	MOTOR ANODE	ANODO MOTORE	ANODE MOTEUR	
	AQ	TEN00745	ÁNODO ESCAPE	ANODO EXHAUST PIPE	ANODO SCARICO	ANODE D'ÉCHAPPEMENT	
		TEN00745AL					
	D-4A, D-4D, AQ, IPS	CEF500114T	IMPULSOR	IMPELLER	GIRANTE	TURBINE	
	D-4E, D-4F, AQ, IPS	JOH09-1028B	IMPULSOR	IMPELLER	GIRANTE	TURBINE	
	D-6A, D-6D, AQ, IPS	JAB17018-0001	IMPULSOR	IMPELLER	GIRANTE	TURBINE	
	D-6E, D-6F, AQ, IPS	JOH09-821B	IMPULSOR	IMPELLER	GIRANTE	TURBINE	
		REC8149182	TERMOSTATO	THERMOSTAT	TERMOSTATO	THERMOSTAT	
		RM21405494	CORREA	BELT	CINGHIA	COURROIE	

### MATERIALES GENÉRICOS PARA REVISIÓN

### GENERIC MATERIALS FOR REVISION

### MATERIALI GENERICI REVIEW

### MATÉRIAUX GÉNÉRIQUES POUR L'EXAMEN

REF				
GS90012	IMPRIMACIÓN PARA MOTOR	SPRAY PRIMER	PRIMER PER MOTORI	PRIMER POUR MOTEUR
PS111044	PINTURA MOTOR GRIS (1995)	GREY ENGINE PAINTS (1995)	PITTURE MOTORE GRIGIO (1995)	PEINTURE MOTEUR GRIS (1995)
GS90034	PINTURA GRIS AQUAMATIC	GREY ENGINE PAINTS AQUAMATIC	PITTURE MOTORE GRIGIO AQUAMATIC	PEINTURE GRIS AQUAMATIC
GS90005	PINTURA MOTOR ROJO (1972+)	RED ENGINE PAINTS (1972+)	PITTURE MOTORE ROSSO (1972+)	PEINTURE MOTEUR ROUGE (1972+)
GS90007	PINTURA MOTOR VERDE AGUA (1972+)	GREEN WATER ENGINE PAINTS (1972+)	PITTURE MOTORE VERDE ACQUA (1972+)	PEINTURE MOTEUR VERT EAU (1972+)
GS90029	PINTURA GRIS AQUAMATIC 89	GREY ENGINE PAINTS AQUAMATIC 89	PITTURE MOTORE GRIGIO AQUAMATIC 89	PEINTURE GRIS AQUAMATIC 89
GS90003	PINTURA GRIS METAL SX/DPX	GREY METAL ENGINE PAINTS SX/DPX	PITTURE MOTORE GRIGIO METALLIZZATO SX/DPX	PEINTURE GRIS MÉTAL SX/DPX
GS90019	BARNIZ TRANSPARENTE PROTECTOR PINTURA EN SPRAY	CLEAR VARNISH, SPRAY PAINT PROTECTOR	VERNICE TRASPARENTE, PROTETTORE DI PITTURA. SPRAY	VERNIS TRANSPARENT, PROTECTEUR
GS90090	PROTECTOR ÓXIDO MOTOR EN SPRAY	SPRAY ENGINE PROTECTOR FROM RUST	PROTETTORE MOTORE DALL'OSSIDAZIONE. SPRAY	PROTECTION MOTEUR CONTRE L'OXYDATION
GS90092	PROTECTOR DIELÉCTRICO EN SPRAY	SPRAY DIELECTRIC PROTECTOR	PROTETTORE DIELETRICO. SPRAY	PROTECTEUR DIELECTRIQUE
LUB11404	BOTE GRASA MARINA 450 g	MARINE GREASE 450 g	GRASSO MARINO 450 g	GRAISSE MARINE 450 g
LUB11363	GRASA DE LITIO	LITHIUM GREASE	GRASSO AL LITIO	GRAISSE LITHIUM

GUÍA MANTENIMIENTO  
TRASMISIONES

GUIDE MAINTENANCE  
TRANSMISSIONS

GUIDA  
MANUTENZIONE  
TRASMISSIONI

GUIDE MAINTENANCE  
TRANSMISSIONS

	REF	OEM				
110S	REC22303438	22303438	PLACA CUBIERTA CONTRA CASCO	COVER PLATE AGAINST HULL	COPERCHIO PIATTO CONTRO SCAFO	JOINTCOLERETTE SAIL DRIVE
	REC877362	21389074	RETÉN DE GOMA	RUBBER SEAL	PARAOLIO IN GOMMA	KIT SOUFFLET
120S,S-B, S-C, S-D, S-E	REC22303438	854932	PLACA CUBIERTA CONTRA CASCO	COVER PLATE AGAINST HULL	COPERCHIO PIATTO CONTRO SCAFO	JOINTCOLERETTE SAIL DRIVE
	REC877362	21389074	RETÉN DE GOMA	RUBBER SEAL	PARAOLIO IN GOMMA	KIT SOUFFLET
270 270T	REC876294	876294	FUELLE TRANSON	DRIVE JOINT BELLOW	CUFFIA TRANSON	SOUFFLET DE CARDAN
	REC875822	875822	MANGUITO (270)	COOLANT HOSE (270)	MANICOTTO (270)	DURITE D'EAU (270)
	REC876631	876631	FUELLE ESCAPE	EXHAUST BELLOW	CUFFIA SCARICO	SOUFFLET D'ÉCHAPPEMENT
280 280TA, PT	REC876294	876294	FUELLE TRANSON	DRIVE JOINT BELLOW	CUFFIA TRANSON	SOUFFLET DE CARDAN
	REC875822	875822	MANGUITO (280, PT)	COOLANT HOSE (280, PT)	MANICOTTO (280, PT)	DURITE D'EAU (280, PT)
	REC876633	876633	FUELLE ESCAPE	EXHAUST BELLOW	CUFFIA SCARICO	SOUFFLET D'ÉCHAPPEMENT
280DP	REC876294	876294	FUELLE TRANSON	DRIVE JOINT BELLOW	CUFFIA TRANSON	SOUFFLET DE CARDAN
	REC875822	875822	MANGUITO	COOLANT HOSE	MANICOTTO	DURITE D'EAU
	REC876631	876631	FUELLE ESCAPE	EXHAUST BELLOW	CUFFIA SCARICO	SOUFFLET D'ÉCHAPPEMENT
290, A 290SP-A, A1, A2, C, C1, E 290DP, A, A1, A2, B, B1, C, C1, D, D1, E	REC876294	876294	FUELLE TRANSON	DRIVE JOINT BELLOW	CUFFIA TRANSON	SOUFFLET DE CARDAN
	RM876632	876632	MANGUITO	COOLANT HOSE	MANICOTTO	DURITE D'EAU
	REC876631	876631	FUELLE ESCAPE	EXHAUST BELLOW	CUFFIA SCARICO	SOUFFLET D'ÉCHAPPEMENT
DPX-S, S1, R, A, G	REC876294	876294	FUELLE TRANSON	DRIVE JOINT BELLOW	CUFFIA TRANSON	SOUFFLET DE CARDAN
	REC3860384	3860384	FUELLE TRANSON (A, AG)	DRIVE JOINT BELLOW (A, AG)	CUFFIA TRANSON (A, AG)	SOUFFLET D'ÉCHAPPEMENT
	RM876632	876632	MANGUITO	COOLANT HOSE	MANICOTTO	DURITE D'EAU
	REC876631	876631	FUELLE ESCAPE	EXHAUST BELLOW	CUFFIA SCARICO	SOUFFLET D'ÉCHAPPEMENT
DPH- A,B,C DPR-A	REC3808898	3594509	FUELLE TRANSON	DRIVE JOINT BELLOW	CUFFIA TRANSON	SOUFFLET DE CARDAN
	RM21132674	21132674	KIT FUELLE (CILINDROS DIRECCIÓN)	ANTI-BARNACLE BELLOW KIT (STEERING CYLINDERS)	KIT CUFFIE (CILINDRI STERZO)	KIT SOUFFLETS (CILINDRE DIRECTION)
	CEF500538K	3588753	FUELLE ESCAPE	EXHAUST BELLOW	CUFFIA SCARICO	SOUFFLET D'ÉCHAPPEMENT
SX-M DP-SM XDP	REC3850426	3850426	KIT FUELLE ESCAPE (SX-M)	BELLOW KIT, EXHAUST (SX-M)	KIT CUFFIA, SCARICO (SX-M)	KIT SOUFFLET D'ÉCHAPPEMENT (SX-M)
	RM21277185	21277185	KIT FUELLE (XDP)	BELLOW KIT, DRIVE (XDP)	KIT CUFFIA (XDP)	KIT SOUFFLET (XDP)
	RM3885870	388587	KIT FUELLE ESCAPE (XDP)	BELLOW KIT, EXHAUST (XDP)	KIT CUFFIA, SCARICO (XDP)	SOUFFLET ÉCHAPPEMENT, KIT (XDP)
SX DPS	REC3841481	22197130	FUELLE TRANSON	DRIVE JOINT BELLOW	CUFFIA TRANSON	SOUFFLET DE CARDAN
	REC3850426	3850426	FUELLE ESCAPE	EXHAUST BELLOW	CUFFIA SCARICO	SOUFFLET ÉCHAPPEMENT
SX-A DPS-A, B	RM22197130	22197130	FUELLE TRANSON	DRIVE JOINT BELLOW	CUFFIA TRANSON	SOUFFLET DE CARDAN
	REC3888916	3888916	FUELLE ESCAPE	EXHAUST BELLOW	CUFFIA SCARICO	SOUFFLET ÉCHAPPEMENT
DPG	REC876294	876294	FUELLE TRANSON	DRIVE JOINT BELLOW	CUFFIA TRANSON	SOUFFLET DE CARDAN
	REC3860384	3860384	FUELLE ESCAPE	EXHAUST BELLOW	CUFFIA SCARICO	SOUFFLET D'ÉCHAPPEMENT
	RM876632	876632	MANGUITO	COOLANT HOSE	MANICOTTO	DURITE D'EAU

KITS MANTENIMIENTO COLAS

DRIVES MAINTENANCE KIT

KIT MANUTENZIONE PIEDE

KITS D'ENTRETIEN DES EMBASSES

		REF					Un.		
SX-A	RECKITSXA	CEF500536K	FUELLE ESCAPE	EXHAUST BELOW	MANICOTTO SCARICO	SOUFFLET D'ECHAPPEMENT	1		
		RECKITVSXAAL	KIT ÁNODOS AL	ANODES KIT AL	KIT ANODI AL	KIT ANODES AL	1		
		RM22197130	FUELLE TRANSMISION	BELLOWS	MANICOTTO TRASMISSIONE	SOUFFLET DE CARDAN	1		
SP-E	RECKITSPE	REC876294	FUELLE TRANSON	BELOW	MANICOTTO TRANSON	SOUFFLET DE CARDAN	1		
		REC876631	FUELLE ESCAPE	EXHAUST BELOW	MANICOTTO SCARICO	SOUFFLET ECHAPPEMENT	1		
		RECKITV290AL	KIT ÁNODOS AL	ANODES KIT AL	KIT ANODI AL	KIT ANODES AL	1		
		REC17276	PIN	PIN	FERMO	GOUPILLE	1		
		REC872096	CASQUILLOS HORQUILLA	TILT BUSHING	GHIERA FORCELLA	BAGUES	2		
		REC897682	JUNTA	GASKET	GUARNIZIONE	JOINT	1		
		REC955974	ARO TÓRICO	O-RING	FASCIA TONDA	JOINT TORIQUE	1		
		REC955989	ARO TÓRICO	O-RING	FASCIA TONDA	JOINT TORIQUE	1		
DPS-SX	RECKITDPS-SX	REC25-30613	ARO TÓRICO	O-RING	FASCIA TONDA	JOINT TORIQUE	2		
		REC3850426	FUELLE ESCAPE	EXHAUST BELOW	MANICOTTO SCARICO	SOUFFLET ECHAPPEMENT	1		
		REC3852045	ARO TÓRICO	O-RING	FASCIA TONDA	JOINT TORIQUE	1		
		RECKITVSXAL	KIT ÁNODOS AL	ANODES KIT AL	KIT ANODI AL	KIT ANODES AL	1		
		REC3852056	PIN	PIN	FERMO	GOUPILLE	1		
		REC3852560	RETEN GOMA	RUBBER SEAL	PARAOLIO GOMMA	JOINT CAOUTCHOUC	1		
		REC3855081	JUNTA	GASKET	GUARNIZIONE	JOINT	1		
		REC955981	ARO TÓRICO	O-RING	FASCIA TONDA	JOINT TORIQUE	1		
		REC3841481	FUELLE TRANSON	U-JOINT BELOW	CUFFIA TRANSON	SOUFFLET DE CARDAN	1		
DPR	RECKITDPR	CEF500537K	FUELLE TRANSMISION	BELLOWS	MANICOTTO TRASMISSIONE	SOUFFLET DE CARDAN	1		
		CEF500538K	FUELLE ESCAPE	EXHAUST BELOW	MANICOTTO SCARICO	SOUFFLET ECHAPPEMENT	1		
		RECKITVDPHAL	ÁNODO	ANODE	ANODO	ANODE	1		
		RECKITVDPHAL	ÁNODO	ANODE	ANODO	ANODE	1		
DPH	RECKITDPH	CEF500537K	FUELLE TRANSMISION	BELLOWS	MANICOTTO TRASMISSIONE	SOUFFLET DE CARDAN	1		
		CEF500538K	FUELLE ESCAPE	EXHAUST BELOW	MANICOTTO SCARICO	SOUFFLET ECHAPPEMENT	1		
DPC-D-E	RECKITDPC-D-E	REC876294	FUELLE TRANSON	BELOW KIT	MANICOTTO TRANSON	SOUFFLET DE CARDAN	1		
		REC876631	FUELLE ESCAPE	EXHAUST BELOW	MANICOTTO SCARICO	SOUFFLET ECHAPPEMENT	1		
		RECKITV290DPAL	KIT ÁNODOS AL	ANODES KIT AL	KIT ANODI AL	KIT ANODES AL	1		
		REC17276	PIN	PIN	FERMO	GOUPILLE	1		
		REC872096	CASQUILLOS HORQUILLA	TILT BUSHING	GHIERA FORCELLA	BAGUES	2		
		REC897682	JUNTA	GASKET	GUARNIZIONE	JOINT	1		
		REC955974	ARO TÓRICO	O-RING	FASCIA TONDA	JOINT TORIQUE	1		
		REC955989	ARO TÓRICO	O-RING	FASCIA TONDA	JOINT TORIQUE	1		
		290SP	RECKIT290SP	REC876294	FUELLE TRANSON	BELOW KIT	MANICOTTO TRANSON	SOUFFLET DE CARDAN	1
REC876631	FUELLE ESCAPE			EXHAUST BELOW	MANICOTTO SCARICO	SOUFFLET ECHAPPEMENT	1		
RECKITV290AL	KIT ÁNODOS AL			ANODES KIT AL	KIT ANODI AL	KIT ANODES AL	1		
REC17276	PIN			PIN	FERMO	GOUPILLE	1		
REC125017	ARO TÓRICO			O-RING	FASCIA TONDA	JOINT TORIQUE	1		
REC876278	CASQUILLOS HORQUILLA			PLASTIC BUSHING	GHIERA FORCELLA	BAGUES	2		
REC876279	CASQUILLOS HORQUILLA			TILT BUSHING	GHIERA FORCELLA	BAGUES	2		
REC897682	JUNTA			GASKET	GUARNIZIONE	JOINT	1		
REC955974	ARO TÓRICO			O-RING	FASCIA TONDA	JOINT TORIQUE	1		
REC955989	ARO TÓRICO			O-RING	FASCIA TONDA	JOINT TORIQUE	1		
290DP	RECKIT290DP			REC876294	FUELLE TRANSON	BELOW KIT	MANICOTTO TRANSON	SOUFFLET DE CARDAN	1
				REC876631	FUELLE ESCAPE	EXHAUST BELOW	MANICOTTO SCARICO	SOUFFLET ECHAPPEMENT	1
		RECKITV290DPAL	KIT ÁNODOS AL	ANODES KIT AL	KIT ANODI AL	KIT ANODES AL	1		
		REC17276	PIN	PIN	FERMO	GOUPILLE	1		
		REC876278	CASQUILLOS HORQUILLA	PLASTIC BUSHING	GHIERA FORCELLA	BAGUES	2		
		REC876279	CASQUILLOS HORQUILLA	TILT BUSHING	GHIERA FORCELLA	BAGUES	2		
		REC897682	JUNTA	GASKET	GUARNIZIONE	JOINT	1		
		REC955974	ARO TÓRICO	O-RING	FASCIA TONDA	JOINT TORIQUE	1		
		REC955989	ARO TÓRICO	O-RING	FASCIA TONDA	JOINT TORIQUE	1		
280DP	RECKIT280DP	REC876294	FUELLE TRANSON	BELOW KIT	MANICOTTO TRANSON	SOUFFLET DE CARDAN	1		
		REC876631	FUELLE ESCAPE	EXHAUST BELOW	MANICOTTO SCARICO	SOUFFLET ECHAPPEMENT	1		
		RECKITV280DPAL	KIT ÁNODOS AL	ANODES KIT AL	KIT ANODI AL	KIT ANODES AL	1		
		REC17276	PIN	PIN	FERMO	GOUPILLE	1		
		REC876278	CASQUILLOS HORQUILLA	PLASTIC BUSHING	GHIERA FORCELLA	BAGUES	2		
		REC897682	JUNTA	GASKET	GUARNIZIONE	JOINT	1		
		REC955974	ARO TÓRICO	O-RING	FASCIA TONDA	JOINT TORIQUE	1		
		REC955989	ARO TÓRICO	O-RING	FASCIA TONDA	JOINT TORIQUE	1		

# SISTEMA DE ALIMENTACIÓN Y FILTRACIÓN FUEL & FILTRATION SYSTEM

## SISTEMA DI ALIMENTAZIONE E FILTRAZIONE SYSTÈME D'ALIMENTATION ET DE FILTRATION



MOTORES GASOLINA

GAS ENGINE

MOTORI BENZINA

MOTEUR ESSENCE

FILTRO DE COMBUSTIBLE Y ELEMENTOS

FUEL FILTERS AND ELEMENTS

FILTRI BENZINA E RACCORDI

FILTRE A ESSENCE ET CARTOUCHE DE RECHANGE

BRACKET

BRACKET

SUPPORTO

TÊTE DE FILTRE À ESSENCE

Con 2 tapones de bronce y 2 tubos de extensión. (2 entradas y 2 salidas).

With 2 brass plugs and 2 extension tubes. (2 inputs & 2 outputs).

Con 2 tappi di bronzo e 2 tubi di estensione. (2 ingressi entrata carburante e 2 uscite carburante).

Avec 2 bouchons en bronze et 2 tubes d'extension. (2 entrées et 2 sorties).

REF		
REC25000	1/4"	AL
REC25010	1/4"	INOX /SS AISI316
REC25020	3/8"	AL
REC25030	3/8"	INOX /SS AISI316
RECOBBRACKET	1/4"	Plast.



REC25000 - REC25020



REC25010 - REC25030



RECOBBRACKET

FILTRO COMBUSTIBLE SEPARADOR DE AGUA

WATER SEPARATING FUEL FILTER

FILTRO SEPARATORE ACQUA-BENZINA

FILTRE À ESSENCE

REF	MICRON	
RACPF5510	10	4 <sup>7</sup> / <sub>16</sub> "

**RACOR**



REF	MICRON	
REC24942	10	4 <sup>7</sup> / <sub>16</sub> " = 11 cm
REC35-802893Q01	10	3 <sup>3</sup> / <sub>4</sub> "
REC855686	28	4 <sup>7</sup> / <sub>16</sub> "
REC35-802893Q	25	3 <sup>3</sup> / <sub>4</sub> "
RACPF5510	10	4 <sup>7</sup> / <sub>16</sub> "

**RECMAR**



REC24942



REC35-802893Q01



REC855686



REC35-802893Q

FILTRO CON BRACKET

Con 2 tapones de bronce y 1 tubo de extensión.

OEM FILTER WITH BRACKET

With 2 brass plugs & 1 extension tube.

FILTRO BENZINA CON SUPPORTO

Con 2 tappi di bronzo e 1 tubo di estensione.

FILTRE A ESSENCE AVEC SUPPORT

avec 2 bouchons en bronze et 1 tube d'extension

REF	MICRON			
REC24950	25	1/4"	50 GPH	AL
REC24952	10	1/4"	50 GPH	AL

**RECMAR**





**FILTRO DECANTADOR GASOLINA****COMPLETE FUEL FILTER****FILTRO DECANTATORE BENZINA****FILTRE DÉCANTEUR POUR ESSENCE****RACOR®**

				RAC120R-RAC-01	RAC320R-RAC-01	RAC320R-INOX-01	RAC320R-RAC-02
FLUJO MÁXIMO	MAX. FLOW	FLUSSO MASSIMO	FLUX MASSIMALE	114 l/h 30 gph	340 l/h 60 gph	340 l/h 60 gph	340 l/h 60 gph
ELEMENTO	ELEMENT	ELEMENTO	ÉLÉMENT	RACS3240	RACS3213	RACS3213	RACS3220UL
CAZOLETA TRANSPARENTE (sólo se recomienda para fueraborda.)	CLEAR BOWL (just for outboards)	VASCHETTA TRASPARENTE (solo nei fuoribordo.)	CAZOLETA TRANSPARENTE (uniquement recommandé pour le hors-bord.)	✓ PLAST.	✓ PLAST.	✓ PLAST.	✗ METAL.
ROSCAS CENTRALES	CENTRAL THREADS	FILETTO CENTRALE	FILS CENTRAUX	M18 x 1.5	1 1/4"	1 1/4"	1 1/4"
TAMAÑO ROSCA CABEZA	HEAD PORT SIZE	DIMENSIONE VITE TESTA	TAILLE DU FIL DE TÊTE	1/4-18 NPTF	1/4-18 NPTF	1/4-18 NPTF	1/4-18 NPTF
ALTURA X Ø	HEIGHT X Ø	ALTEZZA X Ø	HAUTEUR X Ø	166 x 81 x 81 mm	238 x 102 x 102 mm	238 x 102 x 102 mm	238 x 102 x 102 mm
PESO	WEIGHT	PESO	POIDS	0,5 kg	0,9 kg	0,9 kg	0,9 kg
CAIDA DE PRESIÓN	PRESSURE DROP	CADUTA DI PRESSIONE	CHUTE DE PRESSION	0.15 PSI 0.01 bar	0.61 PSI 0.04 bar	0.61 PSI 0.04 bar	0.61 PSI 0.04 bar
PRESIÓN MÁXIMA	MAX. PRESSURE	PRESIONE MASSIMA	PRESSION MAXIMALE	7 PSI 0.05 bar	7 PSI 0.05 bar	7 PSI 0.05 bar	7 PSI 0.05 bar
DESMTAJE CARTUCHO-CAZOLETA	ELEMENT REMOVAL UNDERBOWL	RIMOZIONE DELLA CARTUCCIA	DÉMONTAGE DE LA CARTOUCHE	25,4 mm 1"	25,4 mm 1"	25,4 mm 1"	25,4 mm 1"
TEMPERATURA DE TRABAJO	OPERATING TEMPERATURE	TEMPERATURA DI LAVORO	TEMPERATURE DE TRAVAIL	-40°C +124°C			

**ELEMENTOS DE RECAMBIO****ELEMENT****ELEMENTI DI RICAMBIO****CARTOUCHE DE RECHANGE**

REF	OEM	
RACS3240		RAC120R-RAC-01
LENS3240		
RACS3227	35-886638	
LENS3227		
RACS3213		RAC320R-RAC-01
LENS3213	35-809097	RAC320R-RAC-01 INOX RAC320R-RAC-03
RACS3214	35-809099	
RACS3228UL		RAC320R-RAC-02, bracket RACOR

LENS3240  
LENS3227  
LENS3214RACS3240  
RACS3227  
RACS3214

RACS3228UL

**RÁCORES DE LATÓN****BRASS RACORS****RACCORDI IN OTTONE****RACCORDS EN LAITON**

REF	OEM			
GS31066	22-89771Q2	1/4" NPT	5/16" = 7.9 mm	2
GS31067		1/4" NPT	3/8" = 9.5 mm	2

**GOLDENSHIP**

REF			
GS31065	1/4" NPT	3/8" = 9.5 mm	1
GS31066	1/4" NPT	5/16" = 7.9 mm	2
GS31055	3/8" NPT	3/8" = 9.5 mm	2
GS31056	3/8" NPT	5/16" = 7.9 mm	2
GS31157	3/8" NPT	1/4" = 6.4 mm	2



**FILTRO GASOLINA****FUEL FILTER****FILTRO BENZINA****FILTRE À ESSENCE**

REF	OEM	
REC982230	877765 855952 841054	AQ120B, 125, 131, 151, 171, 175A AQ200C, D AQ225B, C, D, E, F 230, 250, 251, 280A, 290A 255A, B 260A, B, C, AV





REF	OEM	
RACS3228UL	857633	

RECMAR	ORIGIN.	OEM	MICRON	
REC3862228	RM3862228	3862228 3852413 3851218	10	4.3, 5.0, 5.7, 5.8, 7.4, 8.1, 8.2L





RECMAR	ORIGIN.	OEM	MICRON	
REC855686	RM855686-2	855686	28	3.0, 4.3, 5.0, 5.7, 8.1, GXI 430, 431, 432, 434, 500, 501, 570, 571, 572, 740 AQ205, 200, 211, 225, 231, 271, 311 BB225, 231, 260, 261





RECMAR	ORING.	OEM	MICRON		BOMBA PUMP POMPA POMPE
REC3847644	RM3847644	3847644	10	3.0, 4.3, 5.0, 5.7, 8.1, GXI	RM21608511



**FILTRO DE GASOLINA  
CARBURADOR****CARBURETOR FUEL FILTER****FILTRO BENZINA  
CARBURATORE****FILTRE À ESSENCE  
DE CARBURATEUR**

REF	OEM	
REC35-53336	835576	AQ175, 200, 226, 266, 290 B200, 225, 260



REF	OEM	CARB.	
REC93568		Holley 4 bbl	

REF	OEM	
REC40155	3852224	Ford 5.0 / 5.8 Fi, FS



REF	OEM	CARB.			
REC984491	3854019	Rochester			



# FILTRO DE ACEITE

# OIL FILTER

# FILTRO OLIO

# FILTRE A HUILE

REF	OEM	
REC8692305	8692305	4.3L GL-J, GL-JF, GXi-J, GXi-JF 5.0L GXi-J, GXi-JF 5.7L Gi300-J, Gi-300-JF, GXi-J, GXi-JF 8.1L Gi-J, Gi-JF, GXi-J, GXi-JF (2007+)



RECMAR	ORIGIN.	OEM	
REC3850559	RM3850559	3850559	4.3 GXI, OSI, GL 5.0 Gi, GL, OSI, GXI 5.7 GS, GSi, GXi, OSI, GL 7.4 Gi, GL, GSi 8.1 Gi, GSi 8.2GL, GSi



RECMAR	ORIGIN.	OEM	
REC3517857	RM3517857	3517857 1266286 418432 430143	3/4" 16 NPT AQ60, 90, 95, 100, 105, 110, 120, 125, 130, 131, 140, 145, 165, 170, 171 MB20 BB115, 140, 145, 165, 170 230A, B 250A, B 251A



RECMAR	ORIGIN.	OEM	
REC841750	RM841750	841750	18mm x 1.5 AQ175, 205 430A, B 431A, B 432A 434A 4.3 GL,GS,GI



RECMAR	ORIGIN.	OEM	
REC35-06003	RM835440-9	835440 3852030 3852412	13/16" 16 NPT 3.0GL, GS AQ200A, B, C, D 211, 231, 260A, 271, 280A, 290A, 311 225A, B, C, D 500A, B 501A, B 570A, 571A, 572A 740A, B 4.3, 5.0, 5.7, 8.1 GI, GL, GXI 7.4GL, GI, GSi 8.2GSI



RECMAR	OEM	
REC35-06007	835779	3/4" 16 NPT Con base Ford V8 Bloque pequeño V8 Ford small block Con base Ford V8 blocco piccolo Pour moteur Ford V8, petit bloc AQ190A, 240A 5.0FL, FI 5.8FL, FI, FSI



VOLVO





# MOTORES DIESEL

# DIESEL ENGINE

# MOTORI DIESEL

# MOTEUR DIESEL

## FILTRO DE COMBUSTIBLE Y ELEMENTOS

## FUEL FILTERS AND ELEMENTS

## FILTRI BENZINA E RACCORDI

## FILTRE A CARBURANT ET CARTOUCHE DE RECHANGE

REF	OEM	
REC829913	829913	MD5B, C
		MD1B, 2B
		MD3B (19951+, 20838+, 22578+)
		MD7B (3080+)
		MD11C, D (50884+)
		MD7C, D (16372+)
		2001, 2002 2003, T, TB





RECMAR	ORIGIN.	OEM	
REC861477	RM861477	2010A, B, C, D	
		2020A, B, C, D	
		21190113	
		2030A, B, C, D	
		2040A, B, D, D	
3580096	D2-40, 50, 55, 60, 75		
3841080	D1-13, 20		



RECMAR	ORIGIN.	OEM	
REC21139810	RM21139810	21139810	D3-110I-D, I-E, I-F
			D3-140I-E, I-F, A-D, A-E, A-F
			D3-150I-D, I-E, I-F
			D3-170I-D, I-E, I-F, A-D, A-E, A-F
			D3-200I-D, I-E, I-F, A-D, A-E, A-F
			D3-220I-D, I-E, I-F, A-D, A-E, A-F



ORIGIN.	OEM	
RM31261191	31261191 8683212	D3-110I-A
		D3-130A-A, I-A
		D3-160A-A, I-A
		D3-190A-B



RECMAR	ORIGIN.	OEM	
REC3840335	RM3840335	21624740 3840335 3588378	AD41A, B, D
			AD41P, L-A
			AMD44P-A, P-B, P-C
			AQAD40A, B
			AQAD41A
			AQD40A, 41A
			D41A, B, D, L-A
			KAD300A
			KAD32P-A
			KAD42A, 42B, P-A
			KAD44P-A, P-B, P-C
			KAMD300A
			KAMD42A, B, P-A
			KAMD43P-A
			MD22A, B, L-B, P-B
			MD40A
			TAMD22A, P-B
			TAMD40A, B
			TAMD41A, B, D, P, L, M, H-A, H-B
			TMD22A, B, P-C
			TMD40A, B, C
			TMD41A, B, D, L-A



RECMAR	ORIGIN.	OEM	
REC21492771	RM21492771	21492771 3825133 466987 829993	AD31A, B, D, AD, P, L-A
			AQAD30A, 31A
			AQD70C
			D5A-T, A-TA, A-BTA
			D7A-T, A-TA, A-BTA
			KAD32A
			MD30A, B, D, AQ
			MD31A
			MD6A, B
			MD70B
			MD7A, B
			TAMD102A, D
			TAMD122C, D
			TAMD30A, B, D, AQ
			TAMD31A, B, D, P, L, M, S-A
			TAMD60A, B, C
			TAMD61A
			TAMD62A
			TAMD63L-A, P-A
			TAMD70C
			TAMD71B
			TAMD72P-A, WJ-A
			TAMD73P-A, WJ-A
			TAMD74A-A, A-B, C-A, C-B, L-A, L-B, P-A, P-B
			TMD100C
			TMD102KB, KD
			TMD121C, D
TMD30A, B, D, AQ			
TMD31A, B, D, L-A			
TMD70C			
TMD75P-A			





RECMAR	ORIGIN.	OEM		SENSOR SENDER SENSEUR SENSEUR
REC3583443	RM3583443	3583443 21718912	D-4, A-F D-6, A-F (-MY2019)	REC3808616



RECMAR	OEM	
REC3809721	3809721 21140344	D8, 9, 11, 12, 13



ORIGIN.	OEM	
RM23954708	23954708 22984479	D4 D6G (MY2020+)

**new**



RECMAR	OEM	
REC22377272	22377272 3888460	D8, 9, 11, 12, 13, 16



ORIGIN.	OEM	
RM3817517	3817517 3839469 3828838	D9 D11A-A, A-B, A-D D12D-A MG, D-A MH, D-B MH, C-A MP, D-A MP



RECMAR	OEM	
REC864315	864315 863750	D5 TAMD71, 74, 102, 103, 122, 162, 165



RECMAR	OEM	
REC876554	876554	MD1A, 1B, 2A, 2B, 3B MD5A, B (19950+, -20837, -22578) MD11C, D (-50883) MD17C, D (-16371)





FILTRO CON CAZOLETA

BOWL FILTERS

FILTRO CON COPPA

FILTRE AVEC COUPE



**RACOR**

	RAC500MA30	RAC900VMA	RAC900MA30	RAC1000VMA	RAC1000MA30	RAC75/500MAX	RAC75/1000MA30
	227 l/h 60 gph	340 l/h 90 gph	341 l/h 90 gph	681 l/h 180 gph	681 l/h 180 gph	454 l/h 120 gph	681 / 1363 l/h 180 / 360 gph
	2010	2010	2040	2010	2020	2010	2020
A X B X C	292 x 147 x 122 mm	432 x 220 x 200 mm	432 x 152 x 178 mm	557 x 220 x 200 mm	559 x 152 x 178 mm	292 x 368 x 241 mm	559 x 476 x 279 mm
	3/4"-16 UNF	7/8"-14 UNF	7/8"-14 UNF	7/8"-14 UNF	7/8"-14 UNF	3/4"-16 UNF	7/8"-14 UNF
	2 kg	4,9 kg	3 kg	5,6 kg	5 kg	7,7 kg	13,6 kg
CAIDA DE PRESIÓN PRESSURE DROP CADUTA DI PRESSIONE CHUTE DE PRESSION	0.61 PSI 0.04 bar	0.30 PSI 0.021 bar	0.34 PSI 0.02 bar	0.43 PSI 0.03 bar	0.49 PSI 0.03 bar	0.70 PSI 0.05 bar	3.70 PSI 0.25 bar
MAX	15 PSI 1 bar	15 PSI 1 bar	15 PSI 1 bar	15 PSI 1 bar	15 PSI 1 bar	15 PSI 1 bar	15 PSI 1 bar
MÀX.	102 mm	127 mm	127 mm	254 mm	254 mm	102 mm	254 mm

ELEMENTOS DE RECAMBIO

ELEMENT

ELEMENTI DI RICAMBIO

CARTOUCHE DE RECHANGE

REF 500	REF 900	REF 1000	MICRON
RAC2010SM-OR	RAC2040SM-OR	RAC2020SM-OR	2
RAC2010TM-OR	RAC2040TM-OR	RAC2020TM-OR	10
RAC2010PM-OR	RAC2040PM-OR	RAC2020PM-OR	30

**RACOR**



S: SECUNDARIO  
T: PRIMARIO O SECUNDARIO/FINAL  
P: PRIMARIO

S: SECONDARY FINAL  
T: PRIMARY OR SECONDARY FINAL  
P: PRIMARY

S: SECONDARIO  
T: PRIMARIO O SECONDARIO  
P: PRIMARIO

S: SECONDAIRE  
T: PRIMAIRE OU SECONDAIRE  
P: PRIMAIRE

REF	OEM		MICRON
REC3581760	3581760	R500MA	30
REC889419	889419	R900MA	
REC889422	889422	R1000MA	

**RECMAR**



REC3581760

REC889419

REC889422

new



**FILTRO DECANTADOR DIESEL**

**COMPLETE DIESEL FILTER**

**FILTRO DECANTATORE DIESEL**

**FILTRE DECANTEUR DIESEL**

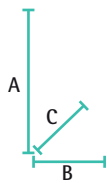

**RACOR**

	RAC120AS	RAC230R2	RAC245R2	RAC460R2	RAC490R2
	57 l/h 15 gph	114 l/h 30 gph	170 l/h 45 gph	227 l/h 60 gph	341 l/h 90 gph
	RACR12	RACR20	RACR25	RACR60	RACR90
	✓	✓	✓	✓	✓
	✓				
CAZOLETA TRANSPARENTE CLEAR BOWL VASCHETTA TRASPARENTE BOL TRASPARENT	✓	✓	✓	✓	✓
INSTALACIÓN VACUÓMETRO VACUUM INSTALLATION INSTALLAZIONE VACUOMETRO INSTALLATION VACUOMETRE	✓	✓	✓	✓	✓
INSTALACIÓN PRESIÓN PRESSURE INSTALLATION INSTALLAZIONE PRESSIONE INSTALLATION PRESSION	✓	✓	✓	✓	✓
A X B X C (mm)	165 x 81 x 81	229 x 102 x 102	267 x 102 x 102	279 x 114 x 121	300 x 114 x 121
	0,59 kg	0,90 kg	1 kg	1,3 kg	1,4 kg
CAIDA DE PRESIÓN PRESSURE DROP CADUTA DI PRESSIONE CHUTE DE PRESSION	0.15 PSI 0.01 bar	0.31 PSI 0.02 bar	0.61 PSI 0.04 bar	0.39 PSI 0.03 bar	0.95 PSI 0.06 bar
	7 PSI	30 PSI	30 PSI	30 PSI	30 PSI
	1/4" NPT	1/4" NPT	1/4" NPT	3/8" NPT	3/8" NPT
BOMBA CEBADO (SÓLO PARA DIESEL) PRIMER PUMP (ONLY DIESEL) POMPA (SOLO PER DIESEL) POMPE (SEULEMENT POUR DIESEL)	✗	✓	✓	✓	✓
Nº TOMAS NUM. OF PORTS Nº FORI Nº D'ENTREE / SORTIE	4	3	3	4	4
OPCIÓN SENSOR AGUA WATER SENSOR OPTION OPZIONE SENSORE ACQUA OPTION SONDE DE PRESENCE D'EAU	✓	✓	✓	✓	✓

**ELEMENTOS DE RECAMBIO**

**ELEMENT**

**ELEMENTI DI RICAMBIO**

**CARTOUCHE DE RECHANGE**

REF	MICRON		REF	MICRON		REF	MICRON	
RACR11T	10		RACR24S	2		RACR60S	2	
			RACR24T	10		RACR60T	10	
			RACR24P	30		RACR60P	30	
REF	MICRON		REF	MICRON		REF	MICRON	
RACR12S	2		RACR25S	2		RACR90S	2	
RACR12T	10		RACR25T	10		RACR90T	10	
RACR12P	30		RACR25P	30		RACR90P	30	
REF	MICRON		REF	MICRON		REF	MICRON	
RACR20S	2		RACR26S	2		RACR120SM	2	
RACR20T	10		RACR26T	10		RACR120TM	10	
RACR20P	30		RACR26P	30		RACR120P	30	

**VOLVO**

**RECAMBIOS MARINOS**



### FILTRO DECANTADOR DIESEL

### COMPLETE DIESEL FILTER

### FILTRO DECANTATORE DIESEL

### FILTRE DECANTEUR DIESEL

REF		
REC1140639	REC3581078	50 l/h



REF		
REC120	RACR12	50 l/h



**RECmar®** new

REF	MICROM			
REC1766160	10	205-420 L/H (2.45PSI)	2 x 11/16" 10 mm	REC160ELEMENT

**RECmar®** new

REF	OEM			
REC500MA	22677639 35-850481 35-850481A1	RAC913-08-H6 (13 mm) RAC913-08-H8 (10 mm)	227 l/h	REC3581760 RAC2010TM-OR

**RECmar®** new

REF		
REC296TWIN	50 L/H	REC3581078

**RECmar®** new

REF			CUBETA BOWL VASCHETTA SEAU	
REC2656613	50 l/h	G30432 (8mm) GS30433 (10 mm)	METAL.	REC3581078





**RECmar®** new

REF			
RECSWK-2000/10	600 L/H	M22X1.5	REC501030
RECSWK-2000/5	300 L/H	M16X1.5	REC500530





FILTROS TIPO SEPAR 2000 FILTER TYPE SEPAR 2000 FILTRI DI TIPO SEPAR 2000 CARTOUCHE DE RECHANGE

REF	MICROM	 (l/h)	 (mm)	 (mm)	 (mm)
RECGS00530	10	300	75	24	75
RECGS01030	30	600	88	55	88
RECGS01830	30	1080	136	55	138

RECMAR®



RECGS00530



RECGS01030

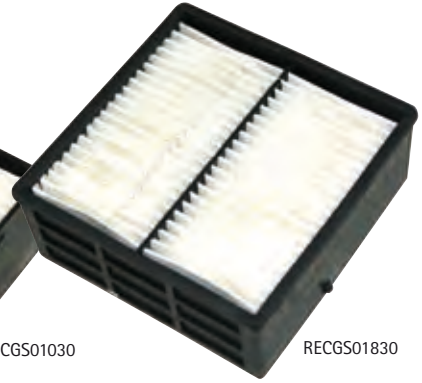

RECGS01830

FILTROS AIRE

AIR FILTER

FILTRI ARIA

FILTRE A AIR

REF	OEM	
REC21379288	21379288 21141341	D3



REF	OEM	
REC842280	842280	AQAD70C, D TMD70C, 100A, 120A, 120B TAMD60A, B, C TAMD70C, D, E TAMD120, 121, 122, 162 MD70C, 71, 74, 165



REF ORIGIN.	OEM	
RM3838952	3838952 3827167	TAMD74A-A, A-B, C-A, C-B, L-A, L-B, P-A, P-B, TAMD75P-A



RECMAR	KIT	OEM	Ø	
REC21646645	RM3582357	21646645 21782391 3582358	165 mm	31, 41 D3-110I-A D3-130I-A D3-160I-A TAMD42WJ-A





REC21646645





RM3582357

REF	OEM	Ø	
REC858488	858488	200 mm	MD31, 41 TAMD42B, WJ-A



REF	OEM	
REC3825038	3825038	TAMD63L-A, L-B, P-A



REF	OEM	
REC21196919	21196919 3885441	D12C-A MP, D-A MH, D-A MP, D-B MH, D-B MP, D-C MH, D-C MP, D-D MP, D-E MH, D-E MP, D-F MP, D-G MH, D-G MP, D-H MP D13B-A MP, B-B MP, B-C MP, B-D MP, B-E MH, B-G MP, B-H MP D16C-A MH, C-B MH, C-C MH, C-A MG



VOLVO

RECAMBIOS MARINOS

REF	OEM		REF	OEM
REC3580509	3580509	D2-50F, 60F	REC3580510	3580510
		D2-55A, B, C, D, E, F		
		D2-75A, B, C, F		
		MD2020B, C, D		
		MD2020B (SN 5101311300+)		
		MD2030B, C, D		
		MD2040A, B, C, D		



REF	OEM	
REC21702999	21702999	D-4, 6, 9, 11
	3818541	
	3583654	



REF	OEM	
REC876185	876185 463505 863344	MD30, 40
		KAMD42A, B, PA
		KAD32P-A, 42A, 43P, 300
		KAD44P, A, B, C
		TAMD61A, 62A, 71, 72

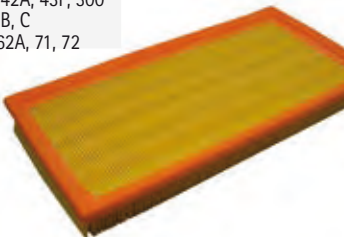

REF	OEM	
REC21171277	21171277	D3-110, 130, 160, 190
	3889484	
	3886591	
	3881586	



FILTRO DE ACEITE

OIL FILTER

FILTRO OLIO

FILTRE A HUILE



RECMAR	ORIG.	OEM	
REC834337	RM834337	834337	MD 1B, 2A, 2B, 3B, MD 5A, B, C MD 6A, 6B, 7A, 7B MD 11C, 11D, 17C, 17D 2001, 2002, 2003 Inversors HS1, IPS-A, B, C, D, E, F
		22057107	
		897321	



RECMAR	ORIG.	OEM	
REC3827069	RM3827069	21549542	MD21A (antiguo   Old   vecchio   ancien) MD21B AQD21B, 32 TAMD61, 63, 71, 72, 73, 74
		3827069	
		829161	



RECMAR	ORIG.	OEM	
REC3581621	RM3581621	3581621	MD21B AQD21B
		21549544	
		861474	
		861475	



RECMAR	ORIG.	OEM	
REC3517857	RM3517857	3517857	MD21A, 22L-B, 30, 31 TMD22, 22B, 31, 36 TAMD22P-B AQD21A KAD32
		1266286	
		418432	
		430143	



RECMAR	ORIG.	OEM	
REC3840525	RM3840525	3840525 3589316	D1-30 D2-40, 50, 55, 60, 75 MD2030A, B, C, D MD2040A, B, C, D





RECMAR	ORIG.	OEM	
REC861473	RM861473	861473 3808605 861826	D1-13, 20 MD2010A, B, C, D MD2020A, B, C, D



RECMAR	OEM	
REC21913334	21913334 21687472	D8A1 D8A2



RECMAR	OEM	
REC3831236	3831236 20821230 21640514	D5 D7



RECMAR	ORIG.	OEM	
REC471034	RM471034	471034	MD40, 41 D70 TD30A KAD43P-A KAMD43P-A



RECMAR	ORIG.	OEM	
REC127695-35150	RM4785974	423135 4785974	KAD42A, 42B, 43, 44 KADM42A, 42B, 43, 44 TAMD60A, B, C TAMD70B, C, D, E TAMD120A, B MD70A, B, C TMD70A, AB, B, C AQD70B, C, D, BL, CL THAMD70B, C TMD100A, C TMD120A, B, C TMD121C





RECMAR	ORIG.	OEM	
REC21707134	RM466634	466634 21707134	TAMD61A, 100, 103A, 120B, 122, 122A TMD102, 120B, 121, 122, 122A, 162



RECMAR	ORIG.	OEM	
REC847741	RM847741	847741	MD61, 62, 63, 71, 72, 73, 74, 75, 102, 103, 122 D5, 7



RECMAR	ORIG.	OEM	
REC861476	RM861476	861476 859746	MD22A, L-A, TMD22





RECMAR	ORIG.	OEM	BY-PASS	
REC3827069	RM3827069	21549542 3827069 829161 829390	✓	61, 63, 71, 72, 73, 74, 75



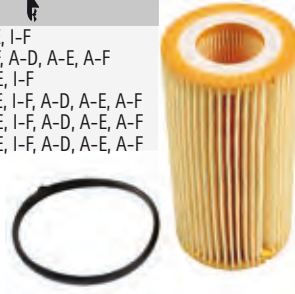

REF	OEM	
REC30788490	30788490	D3-110I-D, I-E, I-F D3-140I-E, I-F, A-D, A-E, A-F D3-150I-D, I-E, I-F D3-170I-D, I-E, I-F, A-D, A-E, A-F D3-200I-D, I-E, I-F, A-D, A-E, A-F D3-220I-D, I-E, I-F, A-D, A-E, A-F



RECMAR	ORIG.	OEM	BY-PASS	
REC3582732	RM3582732	3582732 22030848		D4, 6
REC21632901	RM21632901	21632901 22030852	✓	



REF	OEM	
REC8692305	8692305	D3-110I-A, B, C D3-130IA, B, C D3-160A-A, B, C D3-160I-A, B, C, (2004 +) D3-130A-A, B, C D3-190A, B, C D3-190IB, C, (2005 +)



RECMAR	ORIG.	OEM	BY-PASS	
REC478736	RM478736	21707133 478736	✓	D9, 11, 12, 13, 16, TMD102 TAMD103, 162, 165



REF	OEM	
RM23538670	23538670	DPI



**new**

RECMAR	ORIG.	OEM	BY-PASS	
REC21707132	RM477556	21707132 477556 471392	✓	D9, 11, 12, 13, 16 TAMD103, 162, 165, 193







### FILTRO DE REFRIGERANTE

### COOLANT FILTER

### FILTRO RAFFREDDAMENTO

### FILTRE REFRIGERANT

REF	OEM	
REC21192875	21192875 20532237 1665251	D9 D12 TAMD162, 163, 165



### FILTRO DESVAPORIZADORES

### AIR FILTER CARTER



### FILTRO SFIATO BENZINA FILTRE RENIFLARD

REF	OEM	
REC876069	876069 3830004 876070 849270	D12D, 30,31,40,41 KAD32P TAMD61A, 62A, 63, 70, 71A, 72A, 73, 74, 120, 122, 161, 162, 163,165



REF	OEM	
REC21368879	21368879	D3-110I-G, I-D, I-E, I-F D3-140A-D, A-E, A-F, A-G, I-G, I-E, I-F D3-150I-D, I-E, I-F, I-G D3-170A-D, A-E, A-F, A-G, I-D, I-E, I-F, I-G D3-200A-D, A-E, A-F, A-G, I-D, I-E, I-F, I-G D3-220A-D, A-E, A-F, A-G, I-D, I-E, I-F, I-G



RECMAR	OEM			ORIG.	OEM
REC3584144	3584144	D4 & D6	REC3584145	REC3584145	3584145



new



## RACORS

## RACORS

## RACCORDI

## RACCORDS

REF		
GS30430	8 mm	2
GS30431	10 mm	2

**GOLDENSHIP**

ORIENTABLES  
GUIDEBLE  
ORIENTABILE  
ORIENTABLE

REF		
GS30432	8 mm	2
GS30433	10 mm	2

**GOLDENSHIP**

REF				
RAC1/2X16	1/2"	16 mm		1
RAC1/2X18	1/2"	18 mm	500	1
RAC1/2X20	1/2"	20 mm	900	1
RAC3/8X10	3/8"	10 mm	1000	1
RAC3/8X12	3/8"	12 mm		1
RAC3/8X14	3/8"	14 mm		1

**RACOR**

REF	NPT		
BRA125-3/16x1/4	1/4"	3/16"	1
BRA125-1/4x1/2	1/2"	1/4"	1
BRA125-5/16x3/8	3/8"	5/16"	1
BRA125-3/8x3/8	3/8"	3/8"	1
BRA125-3/8x1/2	1/2"	3/8"	1
BRA125-1/2x3/8	3/8"	1/2"	1
BRA125-1/2x1/2	1/2"	1/2"	1
BRA125-1/2x3/4	3/4"	1/2"	1
BRA125-5/8x3/8	3/8"	5/8"	1
BRA125-5/8x3/4	3/4"	5/8"	1
BRA125-3/4x3/4	3/4"	3/4"	1
BRA125-1x3/4	3/4"	1"	1
BRA125-1/4X3/8	1/4"	3/8"	1

REF	NPT	NPT		
RAC1/2F-1/2M	7/8"	1/2"	900	1
RAC3/8F-3/8M	3/4"	3/8"	1000	1

**RACOR**

**GOLDENSHIP**

REF			
GS31066	1/4" NPT	5/16" = 7.9 mm	2
GS31055	3/8" NPT	3/8" = 9.5 mm	2
GS31056	3/8" NPT	5/16" = 7.9 mm	2

**new**

REF		
REC500MACON	500	3/8" = 10 mm

## MANGUERA CARBURANTE

## FUEL HOSE

## TUBO DI CARBURANTE

## TUYAU DE CARBURANT

Tubo de goma para el transporte de carburante (diesel o gasolina). Construida en goma negra (NBR). Contenido aromático no superior al 60%. Resistente a la abrasión de los agentes marinos.

Long length rubber hose, suitable for loading diesel, bio-diesel and unloading fuel for marine pleasure craft onboard engines up to 24 m.

Tubo in gomma per il passaggio di carburante (diesel o benzina). In gomma nera (NBR). Per motori entrobordo su imbarcazioni da diporto fino a 24m.

Tuyau en caoutchouc pour le passage de carburant (diesel ou essence). Caoutchouc noir (NBR). Pour moteurs in-bord sur bateaux de plaisance jusqu'à 24m.

### CARBO/7840/A1

REF	Ø (mm)						
GS35049	6x16	14 bar	35 mm			40 m	
GS35050	8x17	14 bar	50 mm			40 m	
GS35051	10x19	14 bar	60 mm			40 m	
GS35052	12x22	10 bar	75 mm	-30°C ~ 100°C	30 bars	20 m	Rina CE 0474 Lloyd's Register 96/00/127
GS35053	16x26	10 bar	100 mm			40 m	
GS35054	19x30	10 bar	115 mm			20 m	
GS35055	25x37	10 bar	250 mm			x m	

SAE J 1527 - 2004

USCG A1 R1

ISO 7840 A-1 2004 CE



De goma para diesel y gasolina sin plomo. Ideal para fueraborda. Refuerzos textiles internos. Muy flexible. Contenido aromático 50%.

Rubber Hose suitable for loading mineral oils, diesel and unleaded fuel

In gomma per diesel e benzina senza piombo. Ideale per motori fuoribordo. Tessuto interno rinforzato. Molto flessibile.

En caoutchouc pour diesel et essence sans plomb. Idéal pour les moteurs hors-bord et IB. Tissu intérieur renforcé. Très flexible.

### CARBUPOMP/10NL

REF	Ø (mm)				
GS35031	6x12	10 bar	50 mm	-25°C ~80° C	50 m
GS35032	8x15	10 bar	65 mm		50 m

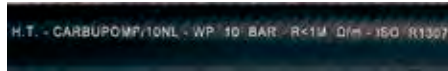

ISO R1307





Manguera para líneas de combustible. Con refuerzo termoplástico que le permite excelente flexibilidad y resistencia a los rayos UV. Color gris. Resistente al alcohol. Especialmente indicado para motores fueraborda.

Marine fuel hose for outboards. Fuel resistant thermo-plastic formulation with 2 spiral reinforcement provides excellent bendability and resistance to UV, aging and permeation by all marine fuels (gasoline/petrol and diesel) including alcohol blends.

Tubi per il condotto del carburante. Con rinforzo termoplastico che gli permette un'eccellente flessibilità e resistenza ai raggi UV. Resistente alle miscele di alcool. Indicato per motori fuoribordo.

Tuyau de carburant marin. La formulation thermoplastique avec 2 renforts en spirale offre une excellente flexibilité et résistance aux UV, au vieillissement et à la perméation de tous les carburants marins (essence et diesel), y compris les mélanges d'alcool.

REF	Ø		
TRI305-0566	8 mm 5/16"	15 m	1
TRI305-0386	10 mm 3/8"	15 m	1

SAE J1527  
ISO-8469 B1



## ACCESORIOS PARA FILTROS

## FILTER ACCESSORIES

## ACCESSORI PER FILTRI

## ACCESSOIRES POUR FILTRES

### LLAVES PARA FILTRO

### FILTER KEY

### CHIAVE DA FILTRO

### CLÉ À FILTRE

REF  
RACRK22628

**RACOR**



REF  
REC70720 65 - 110 mm

**RECMAR**

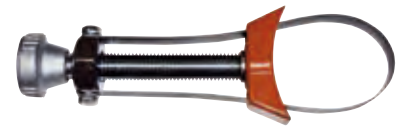

## VÁLVULA DRENAJE AGUA DE FILTROS RACOR

## DRAIN VALVE FOR RACOR FILTERS

## VALVOLA DRENAGGIO ACQUA PER FILTRI RACOR

## VANNE DE DRAINAGE D'EAU POUR FILTRE RACOR

REF  
RACRK19492UL

**RACOR**



## SENSOR DE AGUA PARA FILTROS DIESEL

## WATER SENSOR FOR DIESEL FILTERS

## SENSORE ACQUA PER FILTRI DIESEL

## SONDE DE PRESENCE D'EAU POUR DIESEL

REF  
RECRK21069

**RECMAR**



## RELOJ SENSOR DE AGUA

## WATER ALARM

## ALLARME SENSORE ACQUA

## ALARME SENSOR D'EAU

REF  
RACRK20726

**RACOR**



BOMBA DE COMBUSTIBLE

FUEL PUMP

POMPA COMBUSTIBILE

POMPE À CARBURANT





BOMBA DE COMBUSTIBLE MECANICA

FUEL PUMP MECHANICAL

POMPA COMBUSTIBILE MECCANICA

POMPE À ESSENCE MECANIQUE

REF	OEM	
REC855297	855297 841600	430A 431A AQ205A AQ175A





REF	OEM	
REC826493	826493	500, 501, 570, 572 AQ200, 225, 255, 211, 231, 271, 311, 260, 290



REF	OEM	
REC3854053	3854053	Ford 302, 351 5.0 & 5.8 FLP





REF	OEM		
REC8M0073435	3854858	GM 4 cyl (2.5 / 3.0L) MCM 3.7L 3.0L (SNL097000+)	REC35-8M0046752



REF	OEM	
REC841161	841161	AQ120B, AQ140A, BB140A (últimas versiones   early versions   ultime versione   dernières versions) 230A, B AQ125B AQ131A, B, C, D AQ145A, B BB145A, 250A, B AQ151A, B, C, D AQ171A, C



REF	OEM	
REC3855276	981650 3855276	5.7 GLPMDA, GLIMDA, GLPNCS, GLPLKE, GLPLKR, GSPLKD, GSPLKE







### BOMBA DE COMBUSTIBLE MECANICA

### FUEL PUMP MECHANICAL

REF	OEM	
REC21134777	21134777 833323	MD1B, 2A, 2B, 3B, 5A, 5B, 5C, 6A, 6B, 7A, 7B, 11C, 11D, 17C, 17D 2001, 2002, 2003 (-2301)



REF	OEM	
REC859428	859428	2001, 2002, 2003 (2301+) AQD2B D2A MD1B MD2A, B MD3B MD5A, B, C MD6A, B MD7A, B MD11C, D MD17C, D





REF	OEM	
REC3582500	3582500 3582458 859844	MD22, A, L-A, P-B, L-B TMD22A, B, P-C TAMD22P-B



### POMPA COMBUSTIBILE MECCANICA

### POMPE À CARBURANT MECANIQUE

REF	OEM	
REC21132189	21132189 3584126	D1-13, B, F D1-20, B, F D1-30, B, F D2-40, B, F D2-50F D2-55, B, C, D, E, F D2-60F D2-75, B, C



REF	OEM	
REC3582310	3582310 860320 1542170	30, 31, 40, 41, 42, KAD32D, T KAMD44P-A, KAD44P-A, KAMD300A



REF	OEM	
REC3580100	3580100	2010, 2020, 2030, 2040, A, B, C, D D2-55A, B, C, D, E, F



BOMBA DE COMBUSTIBLE  
ALTA PRESIONHIGH PRESSURE FUEL  
PUMP

REF	OEM	PARA BOMBA FOR PUMP PER POMPA POUR POMPE
RM3588865	3588865	GXI, GI (modernos   Moderns   Moderno   Modernes) 4.3, 5.0, 5.7, 8.1 4.3GIPEFS 5.0GIPEFS 5.7GSIPEFS 7.4GIPEFS, GSIPEFS 8.2GSIPEFS

POMPA COMBUSTIBILE  
ALTA PRESSIONEPOMPE À ESSENCE  
HAUTE PRESSION

REF	PARA BOMBA FOR PUMP PER POMPA POUR POMPE
REC8865	RM21608511



Kit bomba con tóricas y conector.  
Pump kit with o-ring and connetor.  
Kit pompa con anelli e connettore.  
Kit pompe avec toriques et raccord.

REF	OEM	PARA BOMBA FOR PUMP PER POMPA POUR POMPE
REC3817328	3817328	8.1GI, GXI (modernos   Moderns   Moderno   Modernes) 8.1 IPS 3.0 GXIC-J, CXI-J



REF	OEM	PARA BOMBA FOR PUMP PER POMPA POUR POMPE
REC3857650	3857650	4.3, 5.0, 5.7 7.4 GI (bracket: ) 5.0, 5.8 FI, FS (Ford) 120 PSI (Ford sobre enfriador   on cooler   dispositivo di raffreddamento   avec refroidissement)

KITS BOMBA DE ALTA  
PRESIÓNHIGH PRESSURE FUEL  
PUMP, KITKIT POMPA COMBUSTIBILE  
ALTA PRESSIONEKIT POMPE À CARBURANT  
HAUTE PRESSION

REF	OEM	PARA BOMBA FOR PUMP PER POMPA POUR POMPE	PARA BOMBA FOR PUMP PER POMPA POUR POMPE
REC21608512	22608512 23386773 23794966 21545139 21397772 3594785	8.1 (Con regulador de combustible With fuel regulator Con regolatore combustibile Avec regulateur de carburant)	REC3847644

REF	OEM	PARA BOMBA FOR PUMP PER POMPA POUR POMPE	PARA BOMBA FOR PUMP PER POMPA POUR POMPE
RM21608511	21608511 21545138 3594444 3860210 3861355	GXI, GI Moderno 4.3, 5.0, 5.7, 8.1 4.3GIPEFS 5.0GIPEFS 5.7GSIPEFS 7.4GIPEFS, GSIPEFS 8.2GSIPEFS	REC3847644



**BOMBA DE COMBUSTIBLE BAJA PRESION** **LOW PRESSURE FUEL PUMP**

REF	OEM		
REC3858261	3858261 3857986 3850809	5.0, 5.8 (Ford) (bracket:.)	8 PSI 25 gpm



REF	PARA BOMBA FOR PUMP PER POMPA POUR POMPE	
REC8845	RM21608511	



**POMPA COMBUSTIBILE BASSA PRESSIONE**

REF	OEM		
REC3858714	3858714	4.3, 5.0, 5.7, 7.4 GI, GL (bracket:.) GM (Big bloce   Big block   Blocco grande   Big bloc)	8 PSI 45 gpm



**KITS BOMBA DE ALTA PRESION**

**HIGH PRESSURE FUEL PUMP, KIT**

REF		
CARP74021	12 Volt.	4-6PSI /20-30 GPH

Poseen todas las medidas de seguridad exigidas.  
Puede usarse para trasvase de gasoil.  
Listed by Marine Division UL. Used for diesel fuel transfer  
Conforme con tutte le misure di sicurezza necessarie.  
Si può utilizzare per travasi di gasolio.  
Ils disposent de toutes les mesures de sécurité requises.  
Peut être utilisé pour le transfert de carburant diesel.



**KIT POMPA COMBUSTIBILE ALTA PRESSIONE**

**KIT POMPE À CARBURANT HAUTE PRESSION**





**JUNTA BOMBA DE COMBUSTIBLE**

**FUEL PUMP GASKET**

**GUARNIZIONE POMPA COMBUSTIBILE**

**JOINT DE POMPE À CARBURANT**

REF	OEM	
REC3501530	3501530	BB 230/250 251/140/145 AQ120/125/131/140/145/151/171 D31, D41, D30, D40, D42 D300, D43, D44 D13







**KIT CAMISA DE INYECTOR**

**INJEKTOR SLEEVE KIT**

**KIT CAMICIA INIETTORE**

**KIT FOURREAU D'INJECTEUR**

REF	OEM	
REC3581536	3581536	AD31L-A, P-A
		AD41L-A, P-A
		D41L-A
		KAD32P-A
		KAD43P-A
		KAMD43P-A
		TAMD31L-A, M-A, P-A, S-A
		TAMD41H-A, H-B, P-A, L-A, M-A
		TAMD42WJ-A
		TMD31L-A
		TMD41L-A



REF	OEM	
REC861688	861688	KAD44P-A, P-B, P-C
		KAMD44P-A, P-C
		KAD300-A
		KAMD300-A



REF	OEM	
REC889970	889970	D4-180I-B, I-C, I-D, I-F
		D4-210A-A, I-A, I-B
		D4-225A-B, I-B, A-C, A-D, I, A-F, I-F
		D4-260A-F, D-F, I-F
		D4-300A-F, D-F, I-F
		D6-280A-A, A-B, A-C, A-D, A-E, I-A, I-B, I-C, I-D, I-E
		D6-310I-A, A
		D6-300A-F, D-F, I-F, A-F
		D6-330A-F, D-F, I-F
		D6-370A-F, D-F, I-F
		D6-400A-F
		D6-435D-F



REF	OEM	
REC861255	861255	AD31A, B, D, L-A, XD
		AD41A, B, D, L-A, P-A
		AQAD31A
		AQAD41A
		D41A, B, D, L-A
		KAD42A, B, P-A
		KAD43P-A
		KAMD42A, B, P-A
		KAMD43P-A
		MD31A
		TAMD31A, 31B, D, L-A, M-A
		TAMD41A, B, D, H-A, H-B, L-A, M-A, P-A
		TAMD42B, WJ-A
		TAMDS31B TD31ACE,
		TMD31A, B, D, L-A
		TMD41A, B, D, L-A





**new**

REF	OEM	
REC85104134	85104134	D12
	85124676	
	3183241	
	85115324	



**new**

REF	OEM	
REC21351717	21351717	D11, D13, D16, D4, D6, D9
	21274700	
	85113732	
	85116162	



**RETENES Y KITS**

**SEALS & KITS**

**PARAOILI E KIT**

**JOINTS ET KITS**

REF	
REC1302	AQAD41A
	AQD41A
	MD41B, L-A
	KAD42A
	KAD43P
	KAMD42A
	KAMD43P-A
	TAMD41A, B, P-A, L-A, M-A, H-A
TMD41A, B, L-A	





## ARANDELA AL

## WHASER AL

## RONDELLA AL

## RONDELLE AL

new

REF	OEM		
REC957170	957170	2001, 2002, 2003 AQD70, MD70 MD11 MD17 MD5, 6, 7	Ø 9.3 x 6.85 x 1.0 mm
REC957181	957181 18840 1218022		18.2 x 21.9 x 1.5 mm
REC957171	957171		8.3 x 11.3 x 1 mm
REC957184	957184 6613687		25.9 x 21.2 x 1.5 mm
REC1542158	1542158	D30A D40A, B	

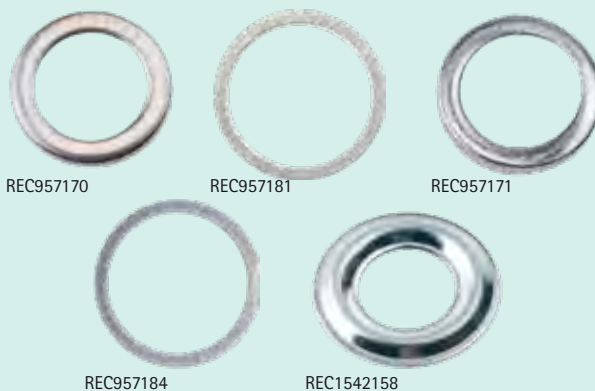



## ARANDELA CU

## WHASER CU

## RONDELLA CU

## RONDELLE CUIVRE

new

REF	OEM			
REC1542159	1542159 18671	D30A D40A, B	14.3 x 20.8 x 1.5 mm	
REC947620	947620 946729 6601761 20459900 969011		8.3 x 11.3 x 1.0 mm	
REC969011	13969011 20459972 21108673		14.3 X 19.2 X 1.5 mm	
REC981183	981183		6.2 x 11 x 1 mm	
REC18818	18818		19.4 x 25.8 x 2mm	
REC947627	947627 13947627			GASOLINA Y AGUA FUEL & WATER COMBUSTIBILE E ACQUA GASOLINE ET EAU
REC11994	11994		12.2 x 17.9 x 1.5 mm	
REC1542157	1542157	D30A D40A, B, C		
REC947622	947622 13947622 20450903 993436 20549894		16.2 x 19.7 x 1.5 mm	



## TÓRICA

## O-RING

## O-RING

## JOINT TORIQUE

new

REF	OEM						
REC976018	976018 955988 13955988	D43, 44 D4300		INFERIOR INYECTOR	INJECTOR DOWN O-RING	INFERIORE INIETTORE	INFÉRIEUR D'INJECTEUR
REC944988	944988	D42, 43, 44 D300	17 x 4.5 mm	VÁLVULA REFLUJO COMBUSTIBLE	FUEL VALVE	VALVOLA COMBUSTIBILE	SOUPAPE ESSENCE
REC3583078	3583078 3887602	D4 / D6		TUERCA INYECTOR	NUT INJEKTOR	DADO INIETTORE	ÉCROU INJECTEUR
				INYECTOR	INJEKTOR	INIETTORE	INJECTEUR

JUNTA TAPÓN LLENADO  
ACEITE DE MOTORENGINE OIL FILLER CAP  
GASKETGUARNIZIONE DEL  
TAPPO DI RIEMPIMENTO  
DELL'OLIO MOTOREJOINT DU BOUCHON  
DE REMPLISSAGE  
D'HUILE MOTEUR

new

REF	OEM	
REC1275379	1275379 940096	D43 D44 D4300



CARBURADOR

CARBURATOR

CARBURATORE



CARBURATEUR

CARBURADORES



CARBURATORS

CARBURATORI



CARBURATEUR

REF	OEM	KIT			
RM21610333	21610333 21132437 3857982 3854086	REC21533394		2	3.0L, GSP, GSM, GLM, GLP





REF	OEM		
MP426574	3855279	4	5.7 GSP 600 CFM



REF	OEM	KIT			
MP426422	3858331 3859066 3854346 21610334 2850245	REC3854020		2	500 CFM 5.7, GLP, GLI



REF	OEM	KIT			
MP426766	3855957	REC3854105		4	7.4L Et 8.2L 750 CFM



KITS ADAPTADORES  
CARBURADORESCARBURETORS ADAPTER  
KITSKIT ADATTATORE  
CARBURATORIKITS ADAPTATEURS DE  
CARBURATEURS

HOLLEY

REF

RECHOL17-6

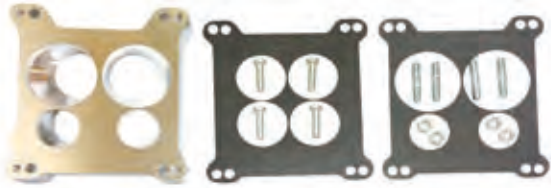

REF

REC2696



REF

OEM



REC27-65577

27-65577

4

REC27-41609

27-41609

4

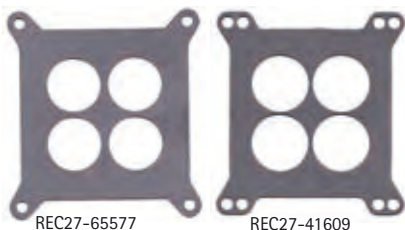

REC27-65577

REC27-41609

REF

OEM



REC27-70142

27-70142

2

REC27-60715

27-60715

2



REC27-70142

REC27-60715

## JUNTAS

## GASKET

## GUARNIZIONE

## JOINTS

REF

OEM

REC27-8079821

841031

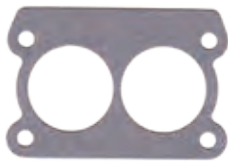

REF

OEM



REC824677

824677

SOLEX Carburetor



REF

OEM



REC3853283

3853283

3.0 GS, GL  
4.3 GL-P, J, JF

## JUNTAS BASE

GASKET CARBURETOR  
BASEGUARNIZIONE BASE  
CARBURATOREJOINT BASE DE  
CARBURATEUR

REF

OEM



REC908765

856033  
826479

V6 Et V8, 4BBL



new

TUBO COMBUSTIBLE  
BOMBA A CARBURADORFUEL TUBE FROM PUMP  
TO CARBURETORTUBO DA COMBUSTIBILE  
A POMPA CARBURATORITUYAU CARBURANT,  
POMPE A CARBURATEUR

REF



REC18-8115

3/8" x 25 - 5/8"

REC18-8114

3/8" x 31" - 5/8"





BOYAS	FLOATS	GALLEGGIANTI	FLOTEURS
-------	--------	--------------	----------

**ROCHESTER**

REF	
REC1397-3327	305" (5.0L) 307" (5.0L) 350" (5.7L) 454" (7.4L) AQ225B, C, D, E, F AQ255A, B AQ260A, B 290A 501A 501A/MS4A 570/S4A



**ROCHESTER & MERCAB**

REF	OEM
REC3302-9031	AQ175A AQ200D, F AQ500A
REC3854018	3854018



**KIT JUNTAS DE CARBURADOR**

**CARBURETOR GASKETS KIT**

REF	OEM	
REC875407	875407	AQ100, 105A, 110, 115, 120 AQ130A, B AQ165A



**KIT GUARNIZIONE CARBURATORI**

**KIT JOINTS CARBURATEURS**

REF	OEM	
REC823426A1	855889	AQ225B, C, D, E, F AQ255A, B AQ260A, B, AV, C AQ290A 1A501A MS4A, 570 MS4A 305"(5.0L) 307"(5.0L) 350"(5.7L) 454"(7.4L)



REF	OEM	
REC841994	841994	AQ175A, 200, 225, 260, 290

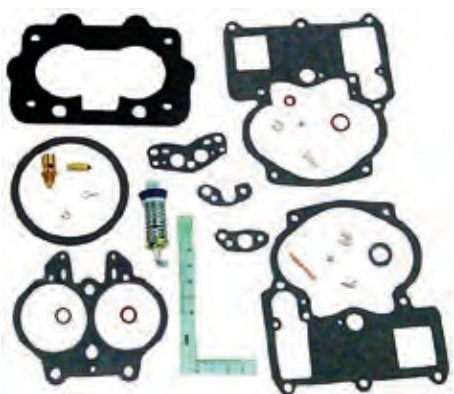

REF	OEM	
REC841294	841293	AQ120B, 140A

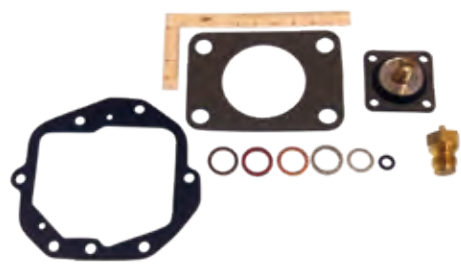

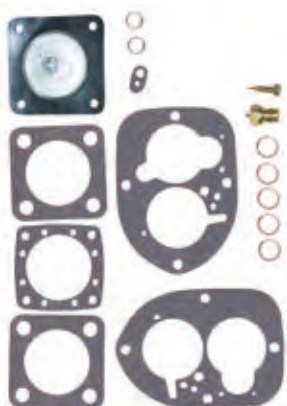

REF	OEM	
REC856472	856472	AQ115A, B AQ125A, B AQ130C, D AQ131A, B, C, D AQ145A, B AQ151A, B, C AQ170A, B, C AQ171A, C



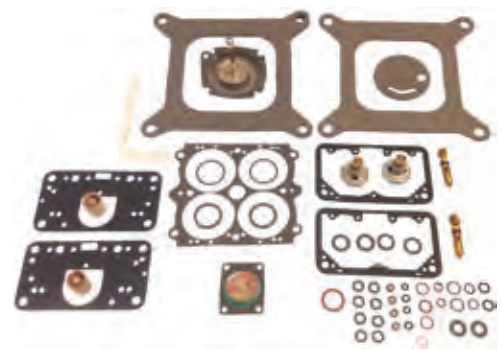

REF	OEM	
REC3855017	3855017	8.2L GL HU, MD



REF	OEM	
REC21533394	854256 21533394	3.0 GL, GS





REF	OEM	
REC3854020	3854020	4.3GL WT, GS WT, GI 5.0L, GL 5.7GL

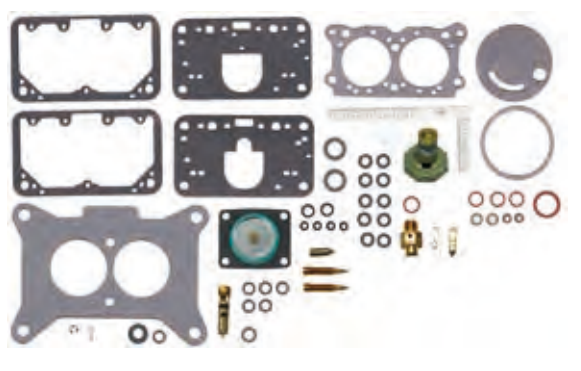

REF	OEM	
REC1396-4656	3854106	HOLLEY (2 bbl) 5.0L, 5.8L FORD FI, FL, SX FORD HO, MD, NC



REF	OEM	
REC1396-5238	3854107	HOLLEY (4 bbl) 4.3L, GL, GS 5.0L, 5.8L FORD HU, MD, NC



REF	OEM	
REC3854105	3854105	7.4L Gi, GL, GSi 8.2L GSi HU, NC, LK, MD

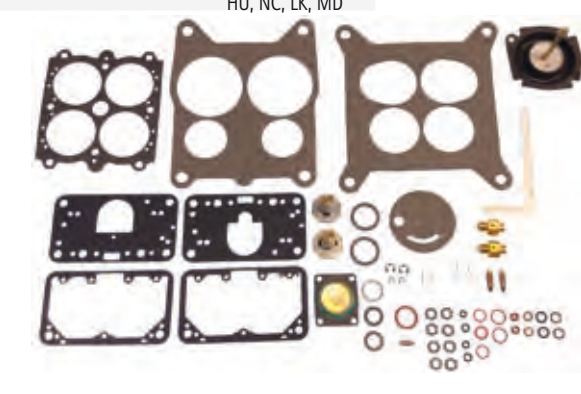

REF	OEM	
REC985052		7.5 FORD HOLLEY (4 bbl)



REF	OEM	
REC76104	740A MS5A	





**GUÍA CARBURADORES**

**GUIDE CARBURETORS**

**GUIDA CARBURATORI**

**GUIDE DES CARBURATEURS**

	CYL.	COD.	CARB.	KIT.	
AQ115A, B AQ125A, B AQ130C, D	4		SOLEX44 PA-1	REC856472	
AQ131A, B, C, D AQ145A, B			SOLEX44 PA-1	REC856472	
AQ120B AQ140A	4		SOLEX44 PHN-3	REC841294	REC3854018
AQ120A AQ130B	4			REC875407	
3.0L GL, GS, GLP	4	H-2	R-80316A, 1A	REC21533394	
AQ170A, B, C	6		SOLEX44 PA-1	REC856472	
AQ175A	6	R-2	17059059	REC841994	REC3302-9031
4.3L GI, GL, GS	6	H-2	R-80312A -A1	REC3854020	
4.3L GI, GL, GS	6	H-4	R-80403A -A1	REC1396-5238	
AQ200D, F AQ500A	8	R-2	17057133	REC841994	
501A, 501A/MS4A, 570/MS4A	8	R-4	17059283,296,298	REC823426A1	REC1397-3327
5.0L, 5.7L GM	8	R-4		REC823426A1	REC1397-3327
5.0L, 5.8L, FORD	8	H-2	R-80382A-1A	REC1396-4656	
5.0L, 5.8L FORD	8	H-4	R-80383A-1A	REC1396-5238	
740 A/MS5A	8	H-4	R-84026AA	REC76104	
7.4 GM ROCHESTER	8	R-4		REC841994	REC1397-3327
7.4L GL	8	H-4	R-80378A-1A	REC3854105	
8.2L GI	8	H-4	R-80378A-1A	REC3855017	
7.5L FORD	8	H-4		REC985052	

**JUNTAS BASE APAGALLAMAS**

**GASKET ARRESTORS**

**GUARNIZIONE PARAFIAMMA**

**JOINT DE PARE FLAMES**

REF	OEM	
REC831239	831239	250/251 AQ & BB 125, 131, 145, 151, 165, 170, 171



new

**TURBO**

**TURBO**

**TURBINE**

**TURBO**

**TUBO**

**TURBO**

**TURBINE**

**TURBO**

	REF	OEM	
TAMD41A, B, D, L-A, H-A, H-B, P-A, M-A TAMD42WJ-A TMD41A, B, D D41A, B, D AQAD41A AD41A, D, B, L-A,P-A KAD42A, B, P-A KAD43P-A KAMD42B, P-A KAMD43P-A	REC861260	861260	REC3582563
MD40A TMD40A, B, C TAMD40A, B AD40B AQD40A AQAD40A, B	REC845294	845294	REC3582595

**RECMAR®**



**VOLVO**

**RECAMBIOS MARINOS**



	REF	OEM	
AD30A AQAD30A MD30, A TAMD30, A TMD30, A	REC846037	846037	REC3582595
AQAD31A AD31A, B, L-A, P-A AD41D D41D TMD31A, B TAMD31A, B, L-A, M-A TAMD41B, D KAD32P-A	REC3581528	3581528	REC3582563
KAD300-A KAMD300-A	REC3802125	3583006	REC3582563
KAMD44P-A, P-C KAD44P, P-B, P-C	REC3802105	3581755	REC3582563
TAMD22P-B TMD22A, B, P-C	REC3802092	3581150	RM859834
TAMD71A, B TAMD61A	REC865428	865428	







REF

OEM



RECMAR®

TMD22A  
TMD22-B  
TMD22P-C

REC861407 861407

RM859834  
REC861414D3-110I-D, I-E, I-F, I-G, I-H D3-140, 150, 170,  
200, 220REC3801387 21163289  
21354008

RM3883844



D3-110I-A, I-B, I-C D3-130, 160

REC3801270 3847392

RM3883844



D3-190

REC3801271 3847393

RM3883844



D4-180, 210, 225

REC3802150 3582769

RM3588435



D4-260

REC3802149 3582768

RM3588435



D4-300



REC3801173 38879363

RM3588435



VOLVO

RECAMBIOS  
MARINOS

	REF	OEM	
D6-280, 300, 310	REC3802152	3584138	RM3588435
D6-330, 350, 370	REC3802151	3584053	RM3588435
D6-400, 435	REC3801138	3809911	RM3588435

**RECMAR®**



REF	OEM	
REC840962	840962	2003T, TB 2003TB SOLAS



**RECmar®**

MANGUERA	TUBE	TUBO	DURITE
REF	OEM		
REC3843854	3843854	D6-400, D6-435	



**RECmar®**

# SISTEMA ELÉCTRICO ELECTRIC SYSTEM

# SISTEMA ELETTRICO SYSTEME ÉLECTRIQUE

## SENSORES      SENSORS      SENSORE      CAPTEURS

### SENSOR TPS      TPS SENDER      SENSORE TPS      CAPTEUR TPS

REF	OEM	
REC803148	3855296	7.4 GSI 8.2 GSI DPX 385, 415 BY/EF WT/HU LK/NC





REF	OEM	
REC853678T	3857487	4.3, 5.0, 5.7, 8.1, 8.2L





REF	OEM	
REC8M0125617	3855184	V6, 305, 350, 454, 502, EFC







### SENSOR MAP      MAP SENSOR      SENSORE MAP      CAPTEUR MAP

REF	OEM	
REC3850396	3850396	4.3, 5.0, 5.7, 7.4L (1994-07) GI, GXI

### SENSOR MAT/MAP      MAT/MAP SENSOR      SENSORE MAT/MAP      CAPTEUR MAT/MAP

REF	OEM	
REC8M0087834	3859020 3858987	V6 GI, GXI V8 GI, GXI

REF	OEM	
REC31216308	31216308	D3-110, 220





### SENSOR IAC      IAC SENDER      SENSORE IAC      SONDE IAC

REF	OEM	
REC3855194	3855194 3855185	4.3, 5.0, 5.7, 7.4 GIIHUBCE, GIINCCCE, GIINCSCE, GIPHUSCE, GIPLKDCE, GIPLKECE, GIPNCACE, GIPNCBCE, GIPNCMCE, GIPNCSCCE, GSIINCC, GSIXHUS, GSIXNCB 8.2 GSIXNCB DPX385XLKE, 415XLKE



REF	OEM	
REC3843751	3843751 3857696	4.3GXIE-M, P, Q, 225-R 7.4 GI 8.1 GI, GXI V6-225-E-A Se instala en el cuerpo de mariposa Installs on the butterfly body Si installa sul corpo farfalla A installer sur le corps de papillon

VOLVO

RECAMBIOS  
MARINOS

## SENSOR PICADO

## KNOCK SENDER

## SENSORE DI CADUTA

## CAPTEUR DE CLIQUETIS



REF	OEM	
REC8M0077616	3854512	7.4 GL, GI, GS 8.2 (1989-01) GS, GS



REF	OEM	
REC3854905	3854905	4.3L (1994-02), 5.0L Gxi-A (2001-02), 5.7L Gil-A (2001), Gi-A, GXI-A, GXI-B, Gil-A, GSil-A, GXil-A, GXil-B (2000-03), 5.7GLPNCS, GIPNACE, GIPNCSCE, GIPNCMCE, GIPNCBCE, GIINCCCE, GIINCSCE (1995-96)



REF	OEM	
REC806612T	3850357 22024631	4.3, 5.0, 5.7L GI / GXI (Modelos modernos   new models   modelli nuovi   Nouveaux modèles)

## SENSOR POSICIÓN ÁRBOL DE LEVAS

## CAMSHAFT SENSOR



## SENSORE POSIZIONE ASSE A CAMME

## SONDE POSITION D'ARBRE A CAMMES



REF	OEM	
REC3863130	3863130	3.0, 4.3, 5.0, 5.7L GI, GXI V6 & V8 Para distribuidor de tapa plana For flat cap distributor Per distributore a coperchio piatto Pour distributeurs avec le couvercle plane



REF	OEM	
REC3859082	3859082 3861323	8.1Gi-A, B, BF, C, CF, D, DF, 8.1LGSi-A, 8.1GXi-A, AF, B, BF, C, 8.1Gi-E, EF, 8.1GXi-D, DF, 8.1OSi-A, AF, 8.1Gil-E, 8.1GXil-D (2001-07)

REF	OEM	
REC8631533	8631533	D3-110 --> D3-190 (I-A, A-A)

REF	OEM	
REC8658726	8658726	D3-110 --> D3-220



## SENSOR POSICIÓN CIGÜENAL

## CRANKSHAFT SENSOR



## SENSORE POSIZIONE ALBERO MOTORE

## SONDE POSITION DE VILEBREQUIN



REF	OEM	
REC892617	3808516	8.1L



REF	OEM	
REC864297T01	3858979	4.3, 5.0, 5.7L Para tapas de distribución de plástico For plastic distribution caps Per tappi di distribuzione in plastica Pour carter de distribution en plastique

REF	OEM	
REC21124849	21124849	V6 (modernos   new   nuovi   nouveau) Para tapas de distribución metálicas For metallic distribution caps Per tappi di distribuzione in metallo Pour carter de distribution en metal



**KIT TEMPERATURA Y PRESIÓN DE ACEITE CON ALARMA**

**COMPLETE TEMPERATURE & OIL PRESSURE WARNING KIT**

**KIT TEMPERATURA PRESSIONE DELL'OLIO CON ALLARME**

**KIT SONDE TEMPERATURE ET PRESSION D'HUILE AVEC ALARME**

REF	OEM
REC41400	



**SENSOR PRESIÓN DE ACEITE**

**OIL PRESSURE SENDER**

**SENSORE PRESSIONE OLIO**

**SONDE DE PRESSION D'HUILE**

REF	OEM		
REC8M0068784	3857532	80 PSI	3.0, 4.3, 5.0, 5.7, 7.4, 8.1, 230A, B, 250A, B



REF	OEM	
REC3808797	3808797	D1-13, 20, 30, D2-40, 55C, 60F, 75



REF	OEM	
REC3852215	3852215	4 cyl V6, V8, 3.0, 4.3, 5.0, 5.7, 7.4, 8.2



REF	OEM	
REC21250645	21250645, 3808796	D1-13, B, F, D1-30, B, F, D1-20, B, F, D2-40, B, F, D2-55D, E, F, D2-60F, D2-75, B, C, F



REF	OEM	
REC3887328	3887328, 3842442	V6 GI, GXI, V8 GI, GXI



REF	OEM	
REC807078	807078	MD1A, 1B, 2A, 2B, 3B, 5A, 5B, 6A, 6B



REF	OEM	
REC1324750	1324750	MB10, B 18, 20, 30, AQ120B, 125A, 140A, 145A, 200B, 210A, 225A, 225B, MD21A, 21B, 29, 32, 2001, 2002, 2003



REF	OEM	ESTACIONES STATIONS STAZIONI STATIONS	
REC866835	866835	1	D31, 32, 41, 42, 43, 44, 63, 72, 74, 75, 103, 122, 162, 165
REC866836	866836	2	D12D, MD2010A, 2020A, 2030A, 2040A



REF	OEM	
REC3545696	3545696	D3-110 --> D3-190



REF	OEM	
REC829587	829587	MD5C, 7A, 7B, 11C, 11D, 17C, 17D



**SENSOR RAIL DE PRESIÓN OIL PRESSURE SENDER SENSORE PRESIONE OLIO SONDE DE PRESSION D'HUILE**

REF	OEM	
REC3843100	3843100 3884352 3587927	D3, D4, D6



**POTENCIÓMETRO MANDO CONTROL POTENTIOMETER POTENZIOMETRO DI CONTROLLO POTENTIOMETRE**

REF	OEM	
REC1336385	1336385	EDC / EVC



**SENSOR DE TEMPERATURA AIRE AIR TEMPERATURE SENSOR SENSORE TEMPERATURA ARIA SONDE DE TEMPERATURE D'AIR**

REF	OEM	
REC805223T	3854527	4.3L EFI 5.0L Gxi-A (2001-02) 5.7L GiL-A (2001) 5.7L Gi-A (2000-01) 5.7L GSil-A (2000-01) 5.7L Gxi-A (2000-01) 5.7L XiL-A (2000-01) 5.7L Gxi-B (2001-02) 7.4L (1994-00) (Varios   Many   Varie   divers) 8.1L (2005+) (Varios   Many   Varie   divers)





**SENSOR TEMPERATURA AGUA WATER TEMPERATURE SENDER SENSORE TEMPERATURA ACQUA SONDE DE TEMPERATURE D'EAU**

REF	OEM	
REC3862500	3862500	3.0, 4.3, 5.0, 5.7, 8.1 En codo de escape For exhaust elbow Per il gomito di scarico Pour coude d'échappement

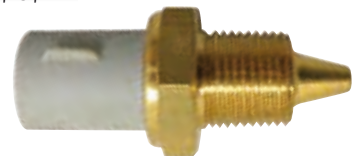

REF	OEM	
REC3854159	3854159	5.0FI, FSi, FLi 5.8FI, FSi, FLi



REF	OEM	
REC872066	872066	3.0, 4.3, 5.0, 5.7L (1998-07)



REF	OEM	
REC806490T	3853787	5.0L FL, FI, 5.8 FL, FI, FSI



REF	OEM	
REC3850397	3850397	D3 4.3 5.0 5.7 7.4 8.1



REF	OEM	ESTACIONES STATIONS STAZIONI STATIONS			
REC827151	827151	1	40-120°C		REC957181
REC840074	840074	2			

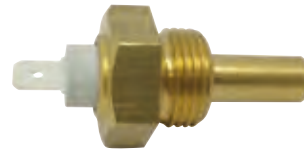

REF	OEM		
REC8653103	8653103	D3-110 --> D3-190	REC957181



**SENSOR AVISADOR DE TEMPERATURA DEL AGUA**

**WATER TEMPERATURE WARNING SENSOR**

**SENSOR ALARMA TEMPERATURA**

**SONDE D'ALARME DE TEMPERATURE**

REF	OEM			
REC873066	873066	97°	D31, 32, 41, 42, 43	REC957181



**SENSOR DE AGUA EN COMBUSTIBLE**

**WATER IN FUEL SENSOR**

**SENSORE AQUA NEL COMBUSTIBILE**

**SONDE DE PRESENCE D'EAU**

REF	OEM	
REC3808616	3808616	D3, 4, 6



REF	OEM	
REC3588916	3588916 874109	D1, 2, 3, 4, 6, 9, 12 31, 30, 41, 42, 43, 44, 300 MD2010, 2020, 2030, 2040 MD22



**SENSOR AVISADOR DE PRESIÓN DE ACEITE**

**OIL PRESSURE WARNING SENSOR**

**SENSORE DI AVVERTIMENTO DELLA PRESIONE DELL'OLIO**

**SONDE ALARME DE PRESSION D'HUILE**

REF	OEM		
REC863169	863169	2001, 2002, 2003 D12D, 31, 32, 40, 41, 42, 43, 44, 60, 61, 71, 72, 73, 74, 75, 100, 102, 103, 120, 121, 122, 162, 300	0.7 bar



**REGULADOR VOLTAJE**

**VOLTAGE REGULATOR**

**REGOLATORI DI VOLTAGGIO REGULATEUR**

REF	OEM	
REC847605	847605	AQ170C MD11A, B, 2B, 3B, 6A, 60, 70, 100, 120 MB10A



**SENSOR DE CIGÜEÑAL Y R.P.M.**

**CRANKSHAFT SENSOR & R.P.M.**

**SENSORE ALBERO MOTORE E R.P.M.**

**SONDE DE POSITION DE VILEBREQUIN**

REF	OEM	
REC21426987	21426987 20513343	D1-13B, 20B, 30B, D2-40F, 55B, 55C, 55D, 55E, 55F, 75B, 75C, 75F D4-180I-B, I-C, I-D, I-E, I-F, D4-210A-A, I-A, I-B D4-225A-B, I-B, A-C, A-D, I-C, I-D, A-E, I-E, A-F, I-F D4-260A-A, A-B, A-C, A-D, D-B, D-C, D-D, I-A, I-B, I-C, I-D, A-E, D-E, I-E, A-F, D-F, DI-F D6-280A-A, A-B, A-C, A-D, A-E, I-A, I-B, I-C, I-D, I-E D4-300A-A, A-C, A-D, D-A, D-C, I-A, I-C, I-D, A-E, D-E, D-D, I-E, A-F, D-F, I-F D6-300A-F, D-F (MC), I-F D6-310I-A, A-A, A-B, A-C, A-D, D-B, D-C, D-D, I-B, I-C, I-D, A-E, D-E, I-E D6-330A-B, A-C, A-D, D-B, D-C, D-D, I-B, I-C, I-D, A-E, D-E, I-E, A-F, D-F, I-F D6-350A-A, A-B D6-370A-B, A-C, A-D, D-B, D-C, D-D, I-A, I-B, I-C, I-D, A-E, D-E, I-E, A-F, D-F, I-F D6-400A-E, A-F D6-435D-A, D-D, D-C, D-E, I-A, I-C, I-D, I-E, D-F, I-SC-F, I-TC-F, I-WJ-F D9A2A D9-425, D9-500, D9-500 (R4), D9-500 (R5), D9-575 D9A2B D9-425, D9-500 (R5), D9-575 D9A2C D9-425 D9A2E D9-425 D9A2F D9-575 D9A2K D9-575 D11A-A, A-B, A-C, A-D, A-C (IPS), A-D (IPS), A-E, A-E (IPS) D12D-A, D-B, D-C, D-E, D-G MH D12C-A, D-A, D-B, D-C, D-D, D-E, D-FP, D-G, D-H MP D13B-A, B-B, B-C, B-D, B-G, B-H, B-J, B-K, B-K (IPS), B-L, B-M MP



**BOMBILLA RELOJ INSTRUMENTOS**

**BULB WATCH INSTRUMENTS**

**LAMPADINA OROLOGIO STRUMENTI**

**AMPOULE ROUGE**

REF	OEM	
REC863946	863946	12V 1.2W Rojo. Compatible con casi todos los instrumentos. Red. Compatible with almost all instruments. Rosso. Compatibile con quasi tutti gli strumenti. Rouge. Compatible avec presque tous les instruments.



**COMPRESOR**

**COMPRESSOR**

**COMPRESSORE**

**COMPRESSEUR**

**MÓDULO ELECTRÓNICO**

**ELECTRONIC MODULE**

**MODULO ELETTRONICO**

**MODULE ELECTRONIQUE**

REF	OEM	
RM860993	860993 860433 860434 860435	KAD42A - KAMD42A (-2204202416)
RM881797	881797 872616	KAD42A - KAMD42A (2204202417+) KAD32, PA

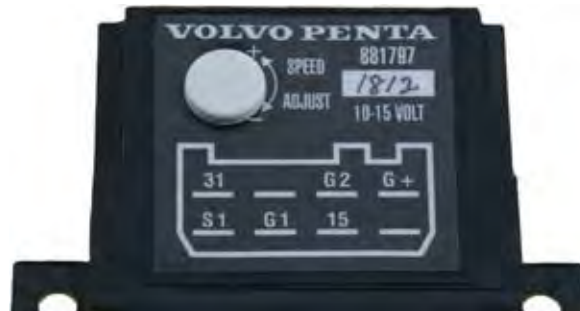

**EMBRAGUE COMPRESOR**

**SOLENOID CLUTCH**

**FRIZIONE COMPRESSORE**

**EMBRAYAGE DE COMPRESSEUR**

REF	OEM	
RM3581724	3581724 3581062 860786	D4-260 KAD32P-A KAD43P-A KAD42 KAD44 KAD300





## MOTORES DE ARRANQUE

## STARTERS

## MOTORINI AVVIAMENTO







## DÉMARREUR

Motor de arranque para sustituir a todos los motores de tamaño pequeño con tornillos fijación en diagonal excepto los 7.4L

Starter to replace all the little engines with diagonally fixation screws excepting 7.4L

Motorino d'avviamento per sostituire tutti i motori V 6 e V 8 con motorini con viti di supporto trasversali eccetto i motori 7.4L

Démarrreur de remplacement pour les moteurs GM 4L V6 et V8 avec des vis de fixation décalées sauf 7.4L

REF	OEM							OEM
REC50-863007A1	3885317 3857747 3660566	12V 1.4 kW	11	14"	REC3859054	4 cyl V6 et V8 3.0L	REC10-861788	10-861788



Motor de arranque Heavy Duty. Tornillos de fijación en diagonal.







Starter with diagonally fixation screws.

Motorino d'avviamento Heavy Duty con viti di supporto trasversali.

Démarrreur à usage intensif. Vis de fixation décalées.

REF	OEM							OEM
REC3885317	3860764	12V 1.7 kW	11	14"	RECPG260	V6 et V8 7.4L	REC10-861788	10-861788



REF	OEM						
REC3854190	3854190 841066	1.4 kW 12V	10		REC0987883	FORD 5.0 et 5.8L	2



Tornillos de fijación en diagonal.

Starter with diagonally fixation screws.

Viti di supporto trasversali.

Vis de fixation décalées

REF	OEM							OEM
REC50-99418A2	3850525 3853982	12V	9	14 <sup>1/4"</sup>	REC3853869	V6 et V8	REC10-861788	10-861788





Motor de arranque pequeño 4 en línea.

Starter Clockwise for 4L.



Viti di supporto trasversali

Démarrreur pour moteur 4 Cyl en ligne. Vis de fixation parallèles

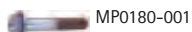
REF	OEM							OEM
REC50-806965A4	3854750 3856003	12V 1.4 kW	11	12 <sup>3/4"</sup>	REC3859054	V6 et V8	MP0180-001 REC10-861788	10-861788



REF	OEM						OEM
REC50-8M0090697	3862308	12V 1.4 kW	11	12 <sup>3/4"</sup>	REC3859054	3.0L V6, V8	MP0180-001 REC10-861788 10-861788

Contrarrrotación o montaje en campana. Starter counter clockwise. Controrrotante, posizionato nella campana. Contre-rotation ou montage sur cloche.

REF	OEM			
REC50-808011A05	21129980 3862985	12V 1.4 kW	9	4, 6 & 8 cyl 5.7 MIE / 6.2 MIE.



REF	OEM			
REC50-97499A2	841377	12V 1.4 kW	9	4, 6 & 8 cyl 4 in line mod.470



REF	OEM			
REC21323043	21323043 3583555 3801351 3803929	12V 1.4 kW	9	D2-50, 55, 60, 75



REF	OEM			
REC21302969	21302969	12V 1.4 kW	9	2030 D1-30 D2-40



REF	OEM			
REC3827444	874385 3827444	24V 6 kW	12	TAD1240, 1241, 1242, 1250, 1251, 1252 D12



REF	OEM	⚡	☀️	🔧
REC873549	872241 859593	12V 1.1 kW	9	HITACHI VALEO AQ120, 125, 145, 131, 151, 171, 251A, 2001, 2002, 2003



REF	OEM	⚡	☀️	🔧
REC3840888	3840888 3803904	12V 0.95 kW	8	MD2010A, B, C, D MD2020A, B, C, D D1-13, B, F D1-20, B, F



REF	OEM	⚡	☀️	🔧
REC3581774	3581774 188486 8599252	12V 3.1 kW	11	VALEO AQ30, 31, 40, 41 AD30, 31, 40, 41 TAMD30, 31, 40, 41, 42, 43, 44, 300

REF	OEM
REC968048	968048



REF	OEM	⚡	☀️	🔧
REC3848965	3848965 3801204 30782228	12V	9	D3-110 --> D3-190



REF	OEM	⚡	☀️	🔧
REC21423488	21423488 3801296 3803938 3803648 3588491 874501 3803855 3804296	12V	11	D4, 6



**DESCONECTOR DE SEGURIDAD**      **CUT OFF SWITCH**      **SCONETTATORE DI SICUREZZA**      **COUPE CIRCUIT DE SECURITE**

REF	OEM
REC40970	3817092
REC40990	22027280



*new*

LLAVES DE ARRANQUE

START KEYS

CHIAVE DI AVVIAMENTO

CONTACTEUR DE DEMARRAGE

REF	OEM	A	
REC3587071	3587071		
RM3587072	3587072		
GS11152	856659	28 mm	3

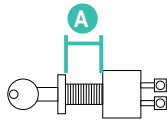

GOLDENSHIP



ALTERNADORES

ALTERNATORS

ALTERNATORI

ALTERNATEURS

ALTERNADORES

ALTERNATORS

ALTERNATORI

ALTERNATEUR

REF	OEM			
REC3884858	3884858 3803577 3803940	12V 130A	D12, 31, 41, 61, 62, 63, 71, 72, 74	



REF	OEM			
REC8676498	8676498 3803645	12V 140 A	6 (50 mm) SERPENTÍN GROOVE PULLEY SERPENTINA SERPENTINE	D3-110 --> D3-190



REF	OEM			
REC874502	874502 3803650 3840181 3803911 3587216 3803846 3819662 3803903	12V 115 A	6 (50 mm) SERPENTÍN GROOVE PULLEY SERPENTINA SERPENTINE	D1-13, B, F D1-20, B, F D1-30, B, F D2-40, B, F D2-55, C, D, E, F D2-60F D2-75, B, C, F D4 D6



Alternador tipo Delco. Con terminal centavueltas y polea simple. Regulador autoexcitante

Delco Type Alternator. With tachometer terminal & simple pulley. Self-exciting regulator.

Alternatore tipo Delco. Con terminale per contagiri e puleggia singola.

Alternateur de type Delco. Avec borne de compte tours et poulie unique.

REF	OEM			
REC841769	873770	12V 63 A	6 (50 mm) SIMPLE SINGLE SINGOLA SIMPLE	D1-30, B, F D2-40, B, F D2-55, C, D, E, F D2-60F D2-75, B, C, F D4 D6

RED +  
CASE -  
BLACK exc  
WHITE tach





REF	OEM	⚡	☪	REG.	🔧
REC3860769	3860769 3854809	12V 55A	SIMPLE SINGLE SINGOLA SIMPLE	INTERNO INTERNAL INTERNO INTERNE	GM 3.0, 4.3, 5.7, 7.4, 8.2 Ford 5.0, 5.8



REF	OEM	⚡	☪	REG.	🔧
REC31419556	31419556 30667118 30659131	12V 150A	5	SERPENTÍN GROOVE PULLEY SERPENTINA SERPENTINE	D3-110 --> D3-220



## MANDO

REF	OEM	⚡	☪	REG.	🔧
REC3860082	3862612 3860798		SERPENTÍN GROOVE PULLEY SERPENTINA SERPENTINE	8.1GiA, B, BF, C, CF, D, DF 8.1GXi-A, AF, B, BF, C, CF 8.1GXil-A, B, C 8.1GSi-A, 8.1Gil-A, B, C, D.	
REC3860171	83857561 3860171	12V 65A	SIMPLE SIMPLE PULLEY NORMALE SIMPLE	INTERNO INTERNAL INTERNO INTERNE	3.0, 4.3, 5.0, 5.7, 5.8, 7.4, 8.2
REC3857813	3857813		SERPENTÍN GROOVE PULLEY SERPENTINA SERPENTINE		3.0, 4.3, 5.0, 5.7, 5.8, 7.4, 8.2



REC3860082



REC3860171



REC3857813

## VALEO

Prácticamente para todos los motores diesel y gasolina con alternador. No incluye polea RM841812

For almost all diesel and gas engines with alternators. PULLEY RM841812 not included.

Utilizzabile per la maggior parte dei motori diesel e benzina con alternatore. Non incluso puleggia RM841812

Pratiquement pour tous les moteurs diesel et à essence avec alternateur. Sans poulie RM841812

REF	OEM	⚡	☪	OEM	REG.
REC873770	873770	12V 60A	RM841812	841812	INTERNO INTERNAL INTERNO INTERNE



## DELCO

REF	OEM	⚡	⊖	REG.	🔧
REC3862612	3862612		SIMPLE SIMPLE PULLEY NORMALE NORMAL 6	INTERNO INTERNAL INTERNO INTERNE	4.3 GLM - E, EF 5.0GL - F, FF
REC3884950	3862665 3884950 3862613	12V 65A	SERPENTÍN GROOVE PULLEY SERPENTINA SERPENTINE		3.0GLP-A, B 3.0GLM-A, B 4.3 & 5.7 EFI



## TRIM

## MOTOR TRIM COMPLETO TRIM ENGINES ASSY MOTORI TRIM COMPLETO MOTEUR TRIM COMPLET

REF	OEM	⚡	MOTOR ENGINE MOTORE MOTEUR	✂️	🔧
REC3586765	3586765 854346 3857265 3861027	12V	REC854525	2	Para colas 280-290 y versiones antiguas SX. For 280-290 drives and SX early versions. Fine thread. Per piedi 280-290 e versione vecchia SX. Pour embases 280-290 et versions anciennes SX. (1976-05)



REF	OEM	⚡	MOTOR ENGINE MOTORE MOTEUR	✂️	🔧
REC3587079	3587079 3857079 3857489 3858069 3860879	12V	REC3861575	2	Para colas SX última versión con rosca gruesa. Complete trim motor for SX drive late model with coarse thread. Per piedi SX ultima versione. Pour embases SX dernières versions.



REF	OEM	⚡	✂️	🔧
REC852928	3586765 852928	12V	3	Modelo antiguo Old Style Modello vecchio Modèle ancien (1977-00)



## MOTOR TRIM HIDRAULICO HYDRAULIC TRIM MOTOR MOTORI TRIM IDRAULICO MOTEUR DE TRIM HYDRAULIQUE

REF	OEM	⚡	KIT	✂️	🔧	
REC854525	3858071	12V	REC3586765	2	4 mm	Para colas 280-290 y versiones antiguas SX. For 280-290 drives and SX early versions. Fine thread. Per piedi 280-290 e versione vecchia SX. Pour embases 280-290 et versions anciennes SX. (1976-05)





**MOTOR TRIM MECÁNICO**

**MECHANICAL TRIM MOTOR**

**MOTORI TRIM MECHANICO**

**MOTEUR DE TRIM MECANIQUE**

REF	OEM			
REC850834	850834	12V	2	ROLL PIN TYPE







**MOTOR TRIM SX**

**SX TRIM MOTOR**

**MOTORI TRIM SX**

**MOTEUR DE TRIM SX**

REF	OEM				
REC3853945	3853945	12V	2	3	(1994+) 3.0 Et 8.2L







**MOTOR TRIM /TILT**

**TRIM/TILT MOTOR**

**MOTORI TRIM / TILT**

**MOTEUR DE TRIM /TILT**

REF	OEM				
REC3861575	3861575	12V	2	2.8 mm	REC3587079

Para colas SX última versión con centros de tornillos a 58,4 mm.  
 Later version 2.3" bolt centers w/coarse thread  
 Per piedi SX ultima versione con misura interna delle viti da 58,4 mm.  
 Pour les embases SX, dernière version avec entraxe des vis à 58,4 mm.

DPH, DPR



**CONVERTIDOR DE 3 A 2 CABLES**

**3 TO 2 WIRE WIRED CONVERTER**

**CONVERTITORE CAVI DA 3 A 2 FILI**

**FAJSCIEAU CONVERTISSEUR 3 A 2 FILS**

REF
REC84-819514T26

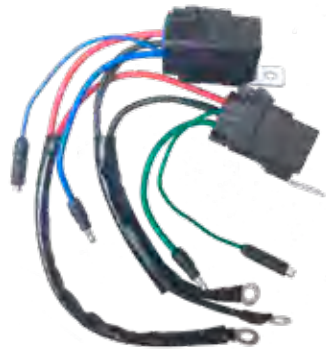

**DEPÓSITO TRIM**

**RESERVOIR TRIM**

**VASCHETTA TRIM**

**RESERVOIR TRIM**

REF	OEM		Ø
REC18525A1	854531	1	
REC883166A2	3861570	4	97 mm
REC3858077	3858077	4	99 mm

REC18525A1





REC883166A2  
REC3858077

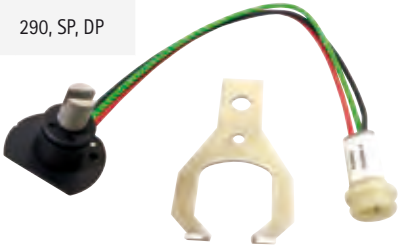

**SENSOR TRIM**      **TRIM SENSOR**      **SENSORE TRIM**      **SONDE DE TRIM**

REF	OEM	
REC22314183	873531 22314183 828726	290, SP, DP





REF	OEM	
REC3858212	21652399 3858212	SX (reloj digital europeo) (digital european gauge) (strumento digitale europeo) (Jauge digitale europe)



REF	OEM	
REC21484383	21484383 3841840	SX-A



REF	OEM		
REC3863007	3849411 3863007 3849413 3855535	3	SX (reloj analógico europeo) (digital analogic gauge) (strumento analogico europeo) (horloge analogique european)



REF	OEM		
REC3594989	3594989 3861837 3854842 3863129	2	SX-M, LT, MDB, MHP, MACLT, MAC, MDC, MBAC



**SOPORTE SENSOR TRIM**      **TRIM SENSOR SUPPORT**      **SUPPORTO SENSORE TRIM**      **SUPPORT SONDE DE TRIM**

REF	OEM
REC3852555	3852555





**PULSADOR TRIM MANDO**      **TRIM CONTROL SWITCH**      **INTERRUTTORE DI CONTROLLO DEL TRIM**      **BOUTON-POUSSOIR TRIM**

REF	OEM
REC3856844	3856844 3856839



**INTERRUPTOR TRIM**      **TRIM SWITCH**      **INTERRUTTORE TRIM**      **INTERRUPTEUR DE TRIM**

REF	OEM	
REC3855650	3855650 876317 853846	DP-D1, C, E, G DPX SP-C1, E SX





TUBO CILINDRO TRIM

TRIM CYLINDER TUBE

TUBO CILINDRO TRIM

TUBE VERIN DE TRIM

REF	
RM TUBOVOLVO	Pistones antiguos   Old piston: Pistone vecchio   Pistones anciennes: 852755, 854610, 853308, 853309, 854550



PISTON TRIM

PISTON TRIM

PISTONE TRIM

VERINS DE TRIM

REF	OEM	
RM3857471	3857471	SX-MLT, MACLT



REF	OEM
RM3860881	3860881 872837



REF	OEM		FULL TILT
REC22187386	22187386 3889955	SX-A, DPS-A	ESTRIBOR STD DESTRA TRIBORD BABOR PORT
REC22187385			



REF	OEM	
REC21840806	21840806 3888301 3857470	DPH, DPR
REC22121309		



HERRAMIENTA PARA TUERCA

TOOL FOR END NUT

STRUMENTO PER DADO

CLE POUR ECROU DE VERIN DE TRIM

REF	PISTONES PISTONS PISTONI VERINS
REC19876	RM3860881 RM872612-7



KIT PISTON TRIM

PISTON TRIM KIT

PISTONE TRIM KIT



KITS VERINS DE TRIM

REF	OEM	
RM3885196	3885196 3850683	Para substituir los pistones (3852414) de colas SX To replace the original piston (3852414) Per sostituire i pistoni del piedi SX (3852414) Remplace les vérins des embases SX (3852414)



REF	OEM	
RM872612-7	872612 854610 853439	Con terminal de horquilla. With terminal. Terminale a forcella Embout à fourche.

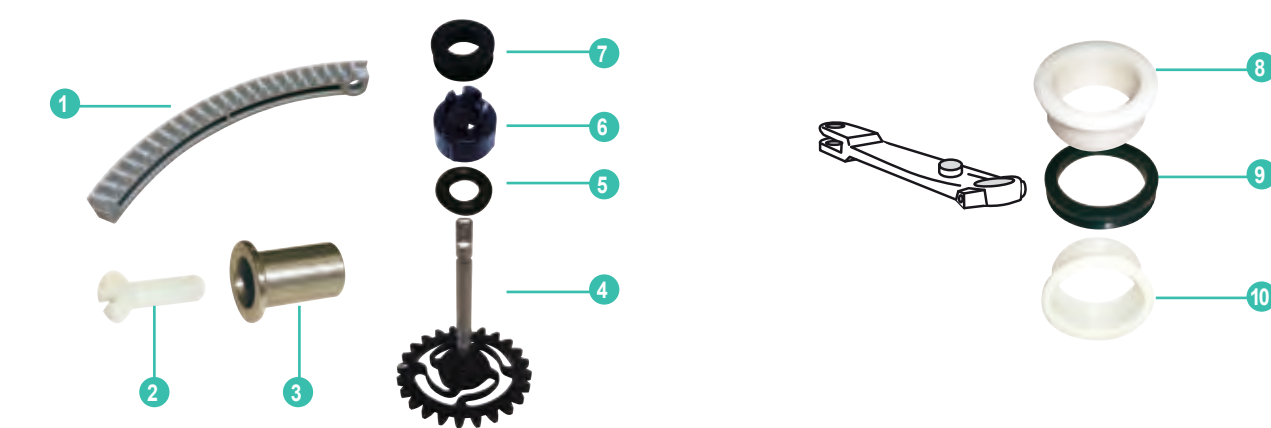

KIT REPARACIÓN TRIM	REAPIR KIT TRIM PISTON	KIT RIPARAZIONE PISTONE TRIM	KIT REPARATION VERIN DE TRIM
<p>REF: RECKITDP</p> <p>PARA FOR PER POUR: RM3860881</p> 	<p>REF: RECKITDP2</p> <p>PARA FOR PER POUR: RM872612-7</p> 	<p>REF: REC22169</p> <p>PARA FOR PER POUR: REC21840806, REC22121309</p> <p>DPH, DPR</p> 	<p>REF: REC22172</p> <p>PARA FOR PER POUR: REC22187386, REC22187385</p> <p>DPS-A, SX-A</p> 
<p>REF: REC19088</p> <p>PARA FOR PER POUR: REC21840806, REC22121309</p> 		<p>REF: REC3854247</p> <p>PARA FOR PER POUR: 3854247</p> <p>SX, DP-SM, SX-M, S, C</p> 	

DESPIECE TRIM	TRIM COMPONENTS	ESPLOSO TRIM	COMPOSANTS DE TRIM	
				
REF	OEM			
1 REC872812	872812 CREMALLERA TRIM	GEAR SEGMENT	CREMAGLIERA	CREMALLERA EN PLASTIQUE
2 REC853759	853759 TORNILLO CREMALLERA	SEGMENT SCREW	VITE CREMAGLIERA	VIS DE CREMALLERE
3 REC853760	853760 CASQUILLO TORNILLO	RIVET NUT	BOCCOLA	ECROU RIVET
4 RM852984-4	852984 PIÑÓN INDICADOR	DRIVE GEAR	PIGNONE INDICATORE TRIM	ROULETTE DE TRIM
5 REC925050	925050 ARANDELA	O-RING	RONDELLA	JOINT TORIQUE
6 REC851430	851430 CASQUILLO	BUSHING	BOCCOLA	ENTRAINEMENT
7 REC966207	966207 RETÉN	SEAL	PARAOLIO	JOINT
8 RM872363	872363 CASQUILLO SUPERIOR (ESTRIADO)	UPPER BUSHING (SPLINE)	BOCCOLA SUPERIORE (SCANALATA)	BAGUE SUPERIEURE (CANNELEE)
8 RM854705	854705 CASQUILLO SUPERIOR (CUADRADO)	UPPER BUSHING (SQUARE)	BOCCOLA SUPERIORE (QUADRATA)	BAGUE SUPERIEURE (CARREE)
9 REC839195	839195 RETÉN (HORQUILLA ESTRIADA)	RING (SPLINE)	PARAOLIO (FORCELLA SCANALATA)	JOINT (CANNELE)
9 RM977313	977313 RETÉN (HORQUILLA CUADRADA)	RING (SQUARE)	PARAOLIO (FORCELLA QUADRATA)	JOINT (CARRE)
10 REC872362	872362 CASQUILLO INFERIOR (ESTRIADO)	LOWER BUSHING (SPLINE)	BOCCOLA INFERIORE (SCANALATA)	BAGUE INFERIEURE (CANNELEE)
10 RM854704	854704 CASQUILLO INFERIOR (CUADRADO)	LOWER BUSHING (SQUARE)	BOCCOLA INFERIORE (QUADRATA)	BAGUE INFERIEURE (CARREE)

**LATIGUILLOS TRIM  
SX-C, SX-R, SX-S**

**TRIM HOSES  
SX-C, SX-R, SX-S**

**TUBI TRIM  
SX-C, SX-R, SX-S**

**FLEXIBLES DE TRIM  
SX-C, SX-R, SX-S**

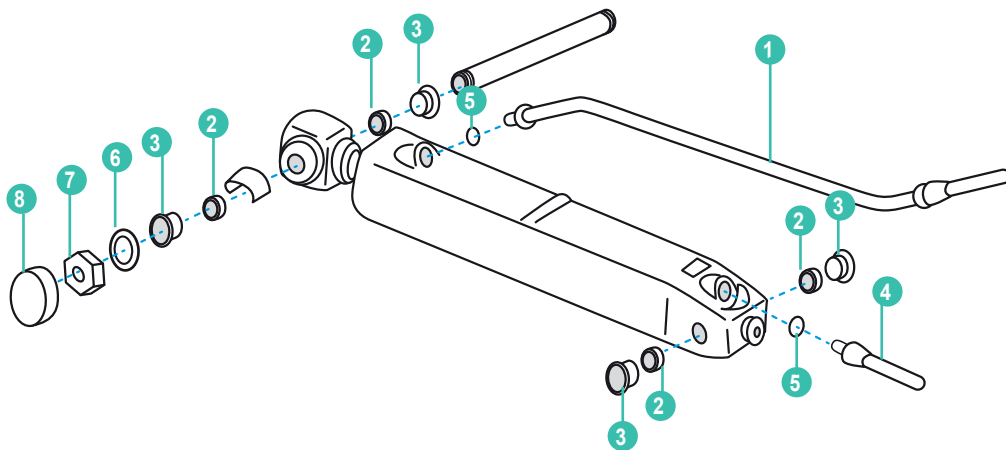

REF	OEM				
1	REC3853854 3853854	LATIGUILLO TRIM ESTRIBOR BAJADA	TRIM HOSE STARBOARD DOWN	TUBO IDRAULICO DESTRA DISCESA	FLEXIBLE TRIBORD BAS
	REC3853856 3853856	LATIGUILLO TRIM BABOR BAJADA	TRIM HOSE PORT DOWN	TUBO IDRAULICO SINISTRA DISCESA	FLEXIBLE BABORD BAS
2	RM3853424 3853424	ARO	RING	O-RING	RONDELLE AXE DE VERIN
3	REC3853423 3853423	CASQUILLO HORQUILLA	BUSHING	BOCCOLA	BAGUE
4	REC3853855 3853855	LATIGUILLO TRIM ESTRIBOR SUBIDA	TRIM HOSE STARBOARD UP	TUBO IDRAULICO DESTRA SALITA	FLEXIBLE TRIBORD HAUT
	REC3853857 3853857	LATIGUILLO TRIM BABOR SUBIDA	TRIM HOSE PORT UP	TUBO IDRAULICO SINISTRA SALITA	FLEXIBLE BABORD HAUT
5	REC3852165 3852165	ARO TÓRICO	O-RING	O-RING	JOINT TORIQUE
6	RM3852573 3852573	ARANDELA	WASHER	RONDELLA	RONDELLE
7	REC11-859135 3852648	TUERCA	NUT	DADO	ECROU
8	RM3852958 3852958	TAPA	CAP	COPERCHIO	CACHE

**LATIGUILLOS TRIM  
SX-M**







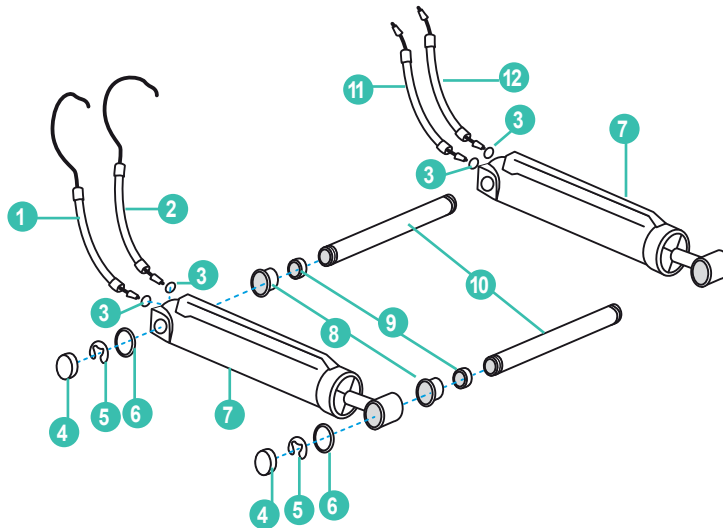

**TRIM HOSES  
SX-M**

**TUBI TRIM  
SX-M**

**FLEXIBLES DE TRIM  
SX-M**



REF	OEM				
1	REC3857523 3857523	LATIGUILLO TRIM	TRIM HOSE	TUBO IDRAULICO	FLEXIBLE DE TRIM
2	REC3853857 3853857	LATIGUILLO TRIM	TRIM HOSE	TUBO IDRAULICO	FLEXIBLE DE TRIM
3	REC3852165 3852165	ARO TÓRICO	O-RING	O-RING	JOINT TORIQUE
4	REC3857522 3857522	TAPA	CAP	COPERCHIO	CACHE
5	REC3857521 3857521	CLIP	CLIP	CLIP	CLIP
6	RM3857588 3857588	ARANDELA	WASHER	RONDELLA	RONDELLE
7	RM3857470 3857470	PISTÓN TRIM	TRIM PISTON	PISTONE TRIM	VERIN DE TRIM
8	REC3853423 3853423	CASQUILLO HORQUILLA	BUSHING	BOCCOLA	BAGUE
9	RM3853424 3853424	ARO	RING	O-RING	RONDELLE AXE DE VERIN
10	RM3857431 3857431	PASADOR	COTTER PIN	CHIAVISTELLO	AXE DE VERIN DE TRIM
11	REC3857524 3857524	LATIGUILLO TRIM	TRIM HOSE	TUBO IDRAULICO	FLEXIBLE DE TRIM
12	REC3853855 3853855	LATIGUILLO TRIM	TRIM HOSE	TUBO IDRAULICO	FLEXIBLE DE TRIM

LATIGUILLOS TRIM		TRIM HOSES		TUBI TRIM		FLEXIBLES DE TRIM	
BOMBA --> TRANSOM		PUMP --> TRANSOM		POMPA --> TRANSOM		POMPE ---> PLATINE	
REF	OEM						
REC852839	852839						
TRANSOM --> PISTÓN		TRANSOM --> PISTON		TRANSOM --> PISTONE		PLATINE --> VERINS	
REF	OEM						
RM857624	857624						
BOMBA --> COLECTOR		PUMP --> MANIFOLD		POMPA --> DISTRIBUTORE		POMPE --> COLLECTEUR	
REF	OEM						
RM3853825	3853825	SX					
BOMBA --> PISTON		PUMP --> PISTON		POMPA --> PISTONE		POMPE --> VERIN	
REF	OEM						
REC873228	873228	DP, DPX	REC873228				
REC873229	873229						
REC21945911	21945911 3884410	SX-A					
COLECTOR --> CILINDRO BABOR (SUBIDA)		MANIFOLD --> CYLINDER PORT (UP)		COLETTORE --> CILINDRO SINISTRA (SALITA)		COLLECTEUR --> VERIN BABORD (HAUT)	
REF	OEM						
REC3853857	3853857	SX					
COLECTOR --> CILINDRO BABOR (BAJADA)		MANIFOLD --> CYLINDER PORT (DOWN)		COLETTORE --> CILINDRO SINISTRA (DISCESA)		COLLECTEUR --> VERIN BABORD (BAS)	
REF	OEM						
REC3853856	3853856	SX	NO SXM, MAC, MDA, MDB, MLT	REC3853856			
REC3857523	3857523	SX SXM, MAC, MDA, MDB, MLT DPS SXM, MAC, MDA, MDB, MLT					
						REC3857523	



COLECTOR --> CILINDRO ESTRIBOR (SUBIDA)

MANIFOLD --> CYLINDER STD (UP)

COLETTORE --> CILINDRO DESTRA (SALITA)

COLLECTEUR --> VERIN TRIBORD (HAUT)

REF	OEM	
REC3853855	3853855	SX



COLECTOR --> CILINDRO ESTRIBOR (BAJADA)

MANIFOLD --> CYLINDER STD (DOWN)

COLETTORE --> CILINDRO DESTRA (DISCESA)

COLLECTEUR --> VERIN TRIBORD (BAS)

REF	OEM		NO
REC3853854	3853854	SX	SXM, MAC, MDA, MDB, MLT SX/DPS
REC3857524	3857524	SX	SXM, MAC, MDA, MDB, MLT



CILINDRO --> BOMBA

CYLINDER --> PUMP

CILINDRO --> POMPA

VERIN --> POMPE

REF	OEM	
REC21721548	21721548 3809559	DPH-A, -B
REC21721550	21721550 3809560	DPR-A, -B

REC21721550



REC21721548

SOLENOIDES , RELÉS Y FUSIBLES

SOLENOID, RELAY & FUSES

SOLENOIDI, RELÉ E FUSIBILE

SOLENOIDE, RELAIS ET FUSIBLES

SOLENOIDES



SOLENOID

SOLENOIDI

SOLENOIDE

REF	OEM	
REC852565	852565	AQD30, 31, 40, 41 AQ131A, B, C, D AQ145A, B AQ151A, B, C AQ171A, C 175A, 205, 231, 260



REF	OEM		
REC3853839	3853839	12V	5.0 & 5.8 FORD FI/FL





SOLENOIDE DE PARADA INYECTORA

STOP SOLENOID

SOLENOIDI STOP

SOLENOIDE DE STOP

REF	OEM		
REC876614	876614	50A	KAD32P-A, 42A, 42B, 42P-A, 43P-A, 44P-A, 44P-B, 44P-C, 300-A KAMD42B, 42P-A, 43P, 43P-A, 43P-B, 300-A TAMD22A, 22P-B, 31B, 31D, 31M-A, 31P-A, 31S-A, 41B, 41D, 42B, 42WJ-A, 41H-A, 41H-B, 41P-A, 41L-A, 41M-A, 42A AD31B, 31D-A, 31L-A, 31P-A, 31XD, 41B, 41D, 41L-A, 41P-A D41B, 41D, 41L-A TMD22-A, 22-B, 22P-C, 31D, 31L-A, 31B, 41D, 41L-A MD22A, 22A-A, 22L-A, 22L-B, 22P-B, 31A MS2A-E, 2B-A, 2B-R, 2A-E, 2B-L, 2L-E, 120S-E TM41B 120S-E



REF	OEM	
REC3584127	3584127	D1-13, B, F D1-20, B, F D1-30, B, F D2-40, B, F D2-55F, B, D, D, E D2-60F D2-75F, B, C



## EXTENSOR DE SOLENOIDE PARA TERMINALES

## SOLENOID EXTENSOR FOR TERMINALS

## PROLUNGA TERMINALE PER SOLENOIDE

## PROLONGATEUR POUR SOLENOIDE

REF
REC855314



## SOLENOIDE ARRANQUE

## STARTER SOLENOID

## SOLENOIDI AVVIAMENTO

## SOLENOIDE DÉMARRAGE

REF	OEM	⚡	STARTER
REC859618	859618	12V	REC3581774
REC0987883	3854194		REC3854190
REC3859054			RECRA122002
			REC50-863007A1 REC50-8M0090697



REC859618



REC0987883

## DELCO REMY

REF	
REC3853869	7,5 cm
REC13037	9,5 cm



REC3859054

## RELÉ CAJA FUSIBLES

## FUSES BOX RELAY

## RELÉ DELLA SCATOLA FUSIBILE

## RELAIS

REF	OEM	⚡	🔧
			V6, V8
REC3861376	3861376	12V	Modelos nuevos New models Modelli nuovi Nouveaux models



## RELÉ STARTER TRIM/TILT

## TRIM/TILT STARTER

## RELÉ TRIM/TILT AVVIAMENTO

## RELAIS DÉMARRAGE TRIM/TILT

REF	OEM	⚡	🔧
RM3841366	3841366		4 cyl, V6, V8 Modelos nuevos New models Modelli nuovi Nouveaux modèles
REC1504952	1504952	12V 30A	131, 145, 175, 250 V8 TMD30, 40 Para   for   per   pour: TRI MEST-1089
REC3854138	3854138	12V	3.0, 4.3, 5.0, 5.7, 5.8, 7.4



RELÉ		RELAY		RELÉ		RELAIS	
REF	OEM						
REC3861375	3861375	12V	3.0L, V6, V8 Modelos nuevos New models Modelli nuovi Nouveaux modèles				
REC1504952	3858809 1504952	12V 30A	(1998 SX-M-MAC, MDA, MLT) 3.0GLP-D 4.3GL-E, GL-EF, GXi-F, GXi-FF, OSi-F, OSi-FF 5.0GL-F, GL-FF, GXi-F, GXi-FF, Si-F, Si-FF, Gi-F/FF, GXi-G/GF, OSi-E/EF, OXi-E/EF, GXi-F, GXi-G 8.1Gi-G/GF, GXi-F/FF, OSi-C/CF, GiL-G, GXiL-F DPH-A, H-B, R-A EF drives SX-M TSKs (1998-05) SX-M DP-SM, (WT drives, PJX-C, PJX-S SX-M, MACLT, -MDA, -MDB, -MPH, -MTD, DP-E, DP-S, -S1, -S2, DP-SM, -SM) XDP-B MD22, 63, 71, 73, 74 30, 40, 61, 70 V8				
REC1324492	1324492	12V 30A	115, 130, 165 MD1, 21, 71				
REC876037	876037	12V 30A	2010, 2020, 2030, 2040 30, 31, 40, 41, 42, 102, V8				
REC841177	841177	12V 30A	V6, V8, 2001, 2002, 2003 AQ125B AQ131A, B, C, D AQ145B AQ151A, B, C				
REC22637542	22637542 846762 873740 860339	12V 70A	2003 MD22 D3 TMAD22 D30, 31, 32, 40, 41, 42, 43, 44				

RELÉ PARADA DE EMERGENCIA	EMERGENCY STOP RELAY	RELÉ ARRESTO DI EMERGENZA	RELAIS DU STOP
---------------------------	----------------------	---------------------------	----------------

REF	OEM			
REC21400091	21400091 873765 11305263	12V	KAD D(EVC)	

RELÉ BOMBA GASOLINA ELÉCTRICA	RELAY FOR FUEL ELECTRIC PUMP	RELE POMPA BENZINA ELETTRICA	RELAIS DE POMPE A ESSENCE
-------------------------------	------------------------------	------------------------------	---------------------------

REF	OEM			
REC3857533	3857533	12V 30/40 A	4.3, 5.0, 5.7, 7.4, 8.2	

## FUSIBLE TÉRMICO MOTOR

IGNITION CIRCUIT  
BREAKER

## FUSIBILE TERMICO MOTORE

FUSIBLE TERMIQUE  
MOTEUR

REF	OEM	⚡
BS2141	841178	40A
BS2142	3854164	50A
BS2143	3854186	60A



## FUSIBLE MOTOR TRIM

## TRIM FUSE ASSY

## FUSIBILE MOTORINI TRIM

FUSIBLE MOTEUR DE  
TRIM

REF	OEM	⚡
REC88-79023T10		110A
RM88-79023A91		90A



## FUSIBLE

## FUZE

## FUSIBILE

## FUSIBLE

REF	OEM	⚡	🔧
REC3819905	3819905 856355 853502 852939	55A	D22, 30, 31, 32, 40, 41, 42, 43, 44, 300 230, 250, 500, 501, 430, 431, 432 AQ131 --> AQ311



## FUSIBLE ATM

## ATM FUZE

## FUSIBILE ATM

## FUSIBLE ATM

REF	⚡	🔧
AM603905	5 A	2
AM603910	10 A	2
AM603915	15 A	2
AM603920	20 A	2
AM603930	30 A	2



## FUSIBLE ATC

## ATC FUZE

## FUSIBILE ATC

## FUSIBLE ATC

REF	⚡	🔧
BS5291	3 A	2
BS5299	4 A	2
BS5292	5 A	2
BS5293	7,5 A	2
BS5294	10 A	2
BS5295	15 A	2
BS5296	20 A	2
BS5297	25 A	2
BS5298	30 A	2

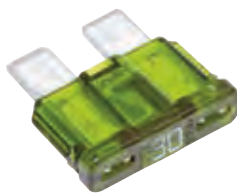

## FUSIBLE MAXI

## MAXI FUZE

## FUSIBILE MAXI

## FUSIBLE MAXI

REF	⚡	🔧
BS5138	30 A	2
BS5139	40 A	2
BS5140	50 A	2
BS5141	60 A	2
BS5142	70 A	2
BS5143	80 A	2

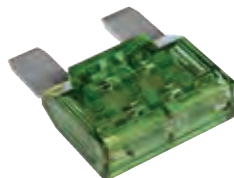





# SISTEMA ENCENDIDO IGNITION SYSTEM

# SISTEMA DI ACCENSIONE SYSTEME D'ALLUMAGE

BOBINAS	COILS	BOBINE	BOBINES
---------	-------	--------	---------

BOBINA DE ENCENDIDO	IGNITION COIL	BOBINA DI ACCENSIONE	BOBINE D'ALLUMAGE
---------------------	---------------	----------------------	-------------------

REF	OEM	
REC3287677	3287677	AQ171A, C AQ251A, (1988-92)



REF	OEM	
REC3854002	3854002	4L, V6 & V8 DELCO





REF	OEM	
REC3859078	3859078	8.1L



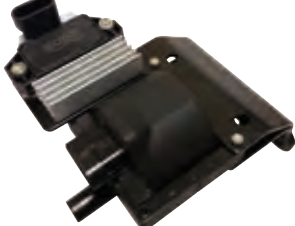

REF	OEM	
REC3861985	3861985	4.3L GXI 5.0L GXI 5.7L GXI



REF	OEM	
REC3854161	3854161	FORD 5.0L / 302Ci EFI 5.8L / 351Ci EFI (1993-96)



REF	OEM	
REC3861267	3861267	8.1Gi-A, B, BF, C, CF, D, DF 8.1GSi-A 8.1GXi-A, AF, B, BF, C DPX375, 420



REF	OEM	
REC21436799	21436799	Delco HVS V6, V8 (Version moderna   Late models   Versione moderna   Versions modernes) GXI



ENCENDIDO ELECTRONICO	ELECTRONIC IGNITION	ACCESIONE ELETTRONICA	BOBINE D'ALLUMAGE ELECTRONIQUE
-----------------------	---------------------	-----------------------	--------------------------------

NO USA RESISTENCIA EXTERNA  
HEI  
Sistema de encendido Thunderbolt

USE WITHOUT EXTERNAL RESISTOR  
HEI  
Thunderbolt ignition system

REF	OEM
REC300-00879	3852217



NON UTILIZZA RESISTENZA ESTERNA  
HEI  
Sistema di accensione Thunderbolt

N'UTILISE PAS DE RESISTANCE EXTERNE  
HEI  
Système d'allumage Thunderbolt.

USA RESISTENCIA EXTERNA  
HEI  
DELCO 1115202

USE WITH EXTERNAL RESISTOR  
HEI  
DELCO 1115202

REF	OEM
REC1463-9382	835998



UTILIZZA RESISTENZA ESTERNA  
HEI  
DELCO 1115202

UTILISE UNE RESISTANCE EXTERNE  
HEI  
DELCO 1115202

MÓDULOS IGNICIÓN

IGNITION MODULES

MODULI AVVIAMENTO

MODULES D'ALLUMAGE

REF	OEM	
REC3854001	3854001	4L, V6 & V8 DELCO



REF	OEM	
REC3854003	3854003	4L, V6 & V8 DELCO



REF	OEM	
REC3858984	3858984	V6 & V8 Vortec





BUJÍAS

SPARK PLUG

CANDELE

BOUGIES

BUJÍAS	SPARK	CANDELE	BOUGIES
			
<b>SERIES AQ</b>		<b>SERIES OCEAN</b>	
120 (B21)	CHARN7YC	GM V-6, 2002 4.3L OSi-XDP	5.7L GS Gen 1+, GSi Gen 1+
125A, B 145	CHARN7YC	GM V-8, 2002 5.0L OSi-XDP	CHARS12YC
130, A, B, C, D	CHARL82YC	GM V-8, 2002 5.7L OSi-XDP	CHARV15YC4
131, A, B, C, D	CHARN7YC	GM V-8, 2002 5.7L OSXi-XDP	CHARS9YC
140, A 145A, B	CHARN7YC	<b>PJX WATER JET</b>	7.4L Gi, GL
151A, B, C	CHARN7YC	4.3L Gi, GS	CHARS12YC
165A	CHARL82YC	<b>SERIES SX COBRA</b>	7.4L Gi L29
170, A, B, C	CHARL82YC	3.0L GS	7.4L GSi, 8.2L GSi
171A, C	CHARN9YC	4.3L GIPNCA	<b>SERIES ALTA CILINDRADA</b>
175, A	CHARV15YC4	4.3L GIPNCS	<b>HIGH HORSEPOWER SERIES</b>
180	CHARJ12YC	5.0L FL	<b>SERIE ALTO CILINDRO</b>
190, A FORD	CHARV15YC4	5.0L Fi, Gi Gen 1+, GL Gen 1+	<b>SERIE HAUTE CILINDRÉE</b>
200, A, B, C, D, F 205A	CHARV15YC4	5.7L Gi, GL, GLi, GS	<b>SERIES M</b>
210A (177315+)	CHARV9YC	5.7L GS Gen 1+, GSi Gen 1+	MB36A, B
211A, DP, 231D, P 271D, P	CHARV15YC4	5.8L FL	MB250S
255, A, C	CHARV15YC4	7.4L Fi, FSi	PZ-200
255D 305 CID 225E, F	CHARV15YC4	7.4L GL, Gi	<b>SERIES INTRABORDA</b>
230A, B 250A, B	CHARN7YC	7.4L Gi L29	<b>INBOARD SERIES</b>
231A, B 240A FORD 255B 280A	CHARV15YC4	<b>SERIES C</b>	<b>SERIE ENTROBORDO</b>
260A, B 271A, B, C, D 290, A, B	CHARV15YC4	C5, 10, 23	<b>SERIE INBOARD</b>
311, A, B 430, 531, 500A, 501A	CHARV15YC4	<b>SERIES DPX</b>	2002, 5.7L Gi
570A, 571A, 572, 740A	CHARV15YC4	7.4L DPX 385	2002, 5, 5.7L GSi, GXi
<b>SERIES B/BB</b>		8.2L DPX 415	5.8L FL/HS1
18A, C 30B	CHARL82C	<b>SERIES DUOPROP</b>	5.8L FSi, HS1
100, A	CHARL86C	4.3L GIPNCA	7.4L GL, Gi/HS1
115A, B 165A	CHARL82YC	4.3L GIPNCS	7.4L Gi L29 STANDARD
140	CHARN9YC	5.0L FL	7.4L Gi L29 PLATINUM
145, A	CHARN7YC	5.0L Fi, 5.0L GL Gen 1+	2002, 8.1L Gi/GSi
225, A, B, C 231A	CHARV15YC4	5.0L Gi GEN 1+	2002, 8.2L GL/HS1
260, A, B, C 261	CHARV15YC4	5.7L Gi, GL, GLi, GS	CHARV15YC4



BUJÍAS			CANDELE		
SPARK			BOUGIES		
	STANDARD	IRIDIUM		STANDARD	IRIDIUM
<b>SERIES AQ</b>			<b>PJX WATER JET</b>		
145A, B	NGKBPR7ES	NGKBPR7EIX	5.7L GS, GSi Gen 1+	NGKBPR6EFS	NGKTR6IX
130, A, B, C, D	NGKBP7HS	NGKBPR7EIX	5.7L GXi	NGKTR55	NGKTR55IX
131, A, B, C, D, 140A	NGKBPR7ES	NGKBPR7EIX	5.8L FL 4 bbl	NGKUR4	NGKUR4IX
150, A, B	NGKXR5		5.7L FSi EFI HO	NGKBPR6EFS	NGKTR6IX
151A, B, C	NGKBPR7ES	NGKBPR7EIX	7.4L Gi EFI, Gi L29	NGKBPR6EFS	NGKTR6IX
165A 170, A, B, C	NGKBP7HS	NGKBPR7EIX	7.4L GL 4 bbl	NGKBR6FS	NGKBR6FIX
171A, C	NGKBPR6ES	NGKBPR7EIX	7.4L GSi EFI	NGKBR6FS	NGKBR6FIX
175, A	NGKYR5	NGKYR5IX	8.1L GXi	NGKTR55	NGKTR55IX
180	NGKXR5	NGKYR5IX	8.2L GSi EFI	NGKBR6FS	NGKBR6FIX
190	NGKYR5	NGKYR5IX	<b>SX COBRA GRANDE</b>		
200, A, B, C, D, F	NGKUR5	NGKUR6IX	3.0L GS 2 bbl	NGKBPR6EFS	NGKTR6IX
210A (177315+)	NGKUR6	NGKUR6IX	4.3L Gi EFI (.460 Rch.)	NGKBPR6FS	NGKUR6IX
211/DP 211A	NGKYR5	NGKYR5IX	4.3L Gi EFI (.708 Rch.)	NGKBPR6EFS	NGKTR6IX
225B, A, B, C, D	NGKUR6	NGKUR6IX	4.3L GL 2 bbl	NGKBPR6EFS	NGKTR6IX
225E, F	NGKYR5	NGKYR5IX	4.3L GS 4 bbl	NGKBPR6EFS	NGKTR6IX
230A, B 250A, B	NGKBPR6ES	NGKBPR6EIX	5.0L Fi EFI	NGKTR5	NGKTR5IX
231/DP 231A, B	NGKYR5	NGKYR5IX	5.0L FL 2 bbl	NGKUR4	NGKUR4IX
240A 255B	NGKUR6	NGKUR6IX	5.0L Gi Gen 1+	NGKBPR6EFS	NGKTR6IX
260, A, B	NGKBR6FS	NGKBR6FIX	5.0L GL Gen 1+	NGKBPR6FS	NGKUR6IX
271/DP	NGKYR5	NGKYR5IX	5.7L Gi EFI	NGKBPR6FS	NGKUR6IX
271A, B, C, D	NGKBR6FS	NGKBR6FIX	5.7L GL 2 bbl	NGKBR6FS	NGKBR6FIX
280A	NGKUR6	NGKUR6IX	5.7L GLi EFI	NGKBPR6FS	NGKUR6IX
290A, B 311A, B	NGKBR6FS	NGKBR6FIX	5.7L GS 4 bbl	NGKBR6FS	NGKBR6FIX
430, 500A, 501A, 531, 570A	NGKBR6FS	NGKBR6FIX	5.7L GS Gen 1+	NGKBPR6EFS	NGKTR6IX
571A, 572, 740A	NGKBR6FS	NGKBR6FIX	5.7L GSi Gen 1+	NGKBPR6EFS	NGKTR6IX
<b>SERIES DPX</b>			5.7L GXi	NGKTR55	NGKTR55IX
5.7L DPX 375	NGKTR55	NGKTR55IX	5.8L FL 4 bbl	NGKUR4	NGKUR4IX
7.4L DPX 385 GSi EFI	NGKBR6FS	NGKBR6FIX	5.8L FSi EFI HO	NGKBPR6EFS	NGKTR6IX
8.1L DPX 420	NGKTR55	NGKTR55IX	7.4L Gi EFI	NGKBPR6FS	NGKUR6IX
8.2L DPX 415 GSi EFI	NGKBR6FS	NGKBR6FIX	7.4L Gi L29	NGKBPR6EFS	NGKTR6IX
<b>SERIES DUOPROP</b>			7.4L GL 4 bbl	NGKBR6FS	NGKBR6FIX
4.3L Gi EFI (.460 Rch.)	NGKBPR6FS	NGKUR6IX	<b>SERIES OCEAN</b>		
4.3L Gi EFI (.708 Rch.)	NGKBPR6EFS	NGKTR6IX	4.3L OSi-XPD	NGKTR5	NGKTR5IX
4.3L GL 2 bbl, GS 4 bbl	NGKBPR6EFS	NGKTR6IX	5.0L OSi-XPD	NGKTR5	NGKTR5IX
5.0L Fi EFI	NGKTR5	NGKTR5IX	5.7L OSi-XPD	NGKTR5	NGKTR5IX
5.0L FL 2bbl	NGKUR4	NGKUR4IX	5.7L OOXi-XPD	NGKTR5	NGKTR5IX
5.0L Gi, GL Gen 1+	NGKBPR6EFS	NGKTR6IX			
5.7L Gi EFI	NGKBPR6FS	NGKUR6IX			
5.7L GL 2 bbl	NGKBR6FS	NGKBR6FIX	REF CHAPROSU		
5.7L GLi EFI	NGKBPR6FS	NGKTR6IX	P 36		
5.7L GS 4 bbl	NGKBR6FS	NGKBR6FIX			

**JUEGOS DE CABLES,  
ALTO RENDIMIENTO**

Núcleo del cable de Kevlar de 8 mm antimagnético. Funda de silicona amarilla. Terminales bujías con muelle de acero inox. Terminal del distribuidor de cobre. Terminales bobina. Silicona resistente a altas temperaturas. Garantía de 5 años.

**HD SPARK PLUG WIRE  
SET**

Antimagnetic Kevlar core. Yellow silicone boot & jacket. SS snaplock. Brass distributor terminal. Coil terminals. High resistant silicone. 5 year warranty.

**KIT CAVI CANDELE,  
ALTE PRESTAZIONI**

Nucleo del cavo di Kevlar da 8 mm antimagnético. Copertura di silicone gialla. Terminali candele con molle di acciaio inox. Terminale lato spinterogeno in rame. Terminale Bobine. Silicone resistente alle alte temperature. Garanzia di 5 anni.

**KIT FAISCEAU DE BOUGIE  
HAUTE PERFORMANCE**

Noyau en Kevlar antimagnétique. Gaine en silicone jaune. Embout de BOUGIES d'allumage avec ressort en acier inoxydable. Terminal de distribution en laiton. Bornes de bobine. Silicone haute résistance. Garantie de 5 ans.

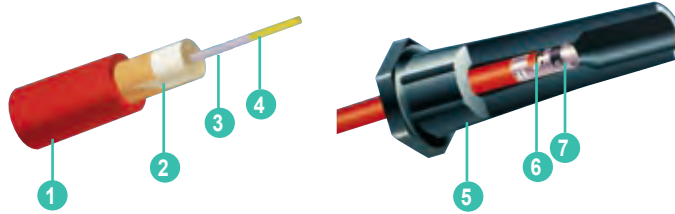

1	2	3	4	5	6	7
CAMISA DE SILICONA DE 8 MM	8 MM SILICONE JACKET	RIVESTIMENTO IN SILICONE DA 8 MM	GAINE SILICONE DE 8MM			
LÁTEX RESISTENTE ALTAS TEMPERATURAS	HEAT RESISTANT LATEX	LATEX RESISTENTE ALLE ALTE TEMPERATURE	LATEX RÉSTANT À HAUTE TEMPÉRATURE			
ACERO INOX	STAINLESS STEEL	ACCIAIO INOX	ACIER INOX			
NÚCLEO DE KEVLAR	KEVLAR CORE	NUCLEO DE KEVLAR	NOYAU DE KEVLAR			
CAPUCHÓN DE SILICONA	SILICONE JACKET	RIVESTIMENTO IN SILICONE	CAPUCHON EN SILICONE			
TRENZADO ESPECIAL FIBRA DE VIDRIO	FIBERGLASS BRAIDING	FIBRA DI VETRO	TRESSE EN FIBRE DE VERRE			
TERMINAL DE ACERO INOX	STAINLESS STEEL TERMINAL	TERMINALE DI ACCIAIO INOX	TERMINAL EN ACIER INOX			

	ARRANQUE IGNITION AVVIAMENTO ALLUMAGE		REF	OEM
	CYL	CONVEN. ELECT.		
4L. Base Volvo	4	✓	REC15-404	875571
V6 Base GM	6	✓	REC15-604	3857166
V8 Base GM	8	✓	REC15-801	3857166
V8 Base GM (Tapa delco plana   Flat Cap   Calotta Delco piatta   tête d'allumeur plane)	8	✓	REC15-806	3857166
4L. Base GM	4		✓	REC15-405 3888324
V6 Base GM	6		✓	REC15-601 3888325
V6 Base GM-MPI	6		✓	REC15-606 3888327
V8 Base GM	8		✓	REC15-804 3888326
V8 5.0/5.7 GM-MPI	8		✓	REC15-815 3888328
V8 8.1L	8		✓	REC15-808 3861295

**DISTRIBUIDOR**
**DISTRIBUTOR**
**SPINTEROGENO**
**ALLUMEUR**
**6 CYL  
AQ170**
**TAPA**
**CAP**
**CALOTTA**
**TÊTE D'ALLUMEUR**

REF	OEM	DELCO	
REC241669	241669	Delco Bosch Ø 73mm	AQ165, 170
REC243658	243658	Delco Bosch Ø 90mm	AQ170B, C

REC241669



REC243658

**PLATINO**
**POINT**
**PUNTINE**
**VIS PLATINÉES**

REF	OEM	
RM243801	243801	AQ170 (Versión moderna   Late models   Versione moderna   Version moderne)

**ROTOR**
**ROTOR**
**ROTORE**
**DOIGT D'ALLUMEUR**

REF	OEM	
REC238258	238258	AQ170 Bosch 6 cyl.





4 CYL

**1 TAPA** **CAP** **CALOTTA** **TÊTE D'ALLUMEUR**

REF	OEM
REC243797	243797
REC841263	841263
REC870690	870690



REC243797      REC841263      REC870690

**2 PLATINO** **POINT** **PUNTINE** **VIS PLATINÉES**

REF	OEM
REC243799	243799
REC1306169	1306169



REC1306169

**3 ROTOR** **ROTOR** **ROTORE** **DOIGT D'ALLUMEUR**

REF	OEM
REC243903	243903



**4 CONDENSADOR** **CONDENSER** **CONDENSATORE** **CONDENSATEUR**

REF	OEM
REC841262	841262 241710



REC841262

**KIT**

REF
REC9-29307



REC243903 + REC243799 + REC841262

	1	2	3	4
AQ115, 120B, 130, 140A	REC243797	REC243799	REC243903	REC841262
AQ120B				
AQ125A, B				
AQ131A, B, C, D				
AQ140A				
AQ145A, B	REC841263	REC243799	REC243903	
AQ151A, B, C				
AQ230A				
AQ250A				
AQ115A, B				
AQ120	REC870690	REC1306169	REC243903	REC841262
AQ130A, B, C, D				

## PRESTOLITE

**1 TAPA** **CAP** **CALOTTA** **TÊTE D'ALLUMEUR**

REF	OEM
REC392-9086T	841926
REC392-9766	3853815
REC835702	835702



REC392-9086T      REC392-9766      REC835702

**2 PLATINO** **POINT** **PUNTINE** **VIS PLATINÉES**

REF	OEM
REC8M6001219	835705



**3 ROTOR** **ROTOR** **ROTORE** **DOIGT D'ALLUMEUR**

REF	OEM
REC3853801	3853801
REC834975	834975



REC3853801      REC834975

**4 CONDENSADOR** **CONDENSER** **CONDENSATORE** **CONDENSATEUR**

REF	OEM
REC8M6001249	835704



## KIT

REF
REC392-6324Q1



REF
REC392-6325Q1



1

2

3

4

V6 PRESTOLITE AQ175A AQ205A AQ430A, B AQ431A, B	REC392-9086T	REC8M6001219	REC3853801	REC8M6001249
V8 PRESTOLITE (Atornillado   <a href="#">screw-down</a>   <a href="#">Avvitato</a>   <a href="#">vissée</a> )				
AQ211A				
AQ231A, B				
AQ271A, B	REC392-9766	REC8M6001219	REC3853801	REC8M6001249
AQ311A				
AQ500A, B				
AQ501A, B				
V8 PRESTOLITE (Clip)				
190A, 200D, 225D, 240A, 255B, 260A, 280A, 290A	REC835702	REC8M6001219	REC834975	REC8M6001249

**MALLORY**  
**AQ210A, 200B, 225A,B,C,255A,B**

TAPA

CAP

CALOTTA

TÊTE D'ALLUMEUR

REF	OEM
REC12532	841244



PLATINO

POINT

PUNTINE

VIS PLATINÉES

REF	OEM
REC391-5090	835304



ROTOR

ROTOR

ROTORE

DOIGT D'ALLUMEUR

REF	OEM
REC841243	841243



CONDENSADOR

CONDENSER

CONDENSATORE

CONDENSATEUR

REF	OEM
REC8M6001217	835308

**MALLORY**

TAPA

CAP

CALOTTA

TÊTE D'ALLUMEUR

REF	OEM
REC982209	508932



PLATINO

POINT

PUNTINE

VIS PLATINÉES

REF	OEM
REC391-5090	835304



ROTOR

ROTOR

ROTORE

DOIGT D'ALLUMEUR

REF	OEM
REC89825302	508935



CONDENSADOR

CONDENSER

CONDENSATORE

CONDENSATEUR

REF	OEM
REC8M6001217	835308



KIT

REF
REC391-5090Q1



REC89825302 + REC391-5090 + REC8M6001217

**4-CYL DELCO EST  
GM 3.0L / 181CI / 4-CYL**

TAPA

CAP

CALOTTA

TÊTE D'ALLUMEUR

REF	OEM
REC3854260	3854260



ROTOR

ROTOR

ROTORE

DOIGT D'ALLUMEUR

REF	OEM
REC3854261	3854261



CABLES

WIRE

CAVI

FAISCEAU

REF	OEM
REC15-405	

**V6 DELCO EST  
GM 4.3L / 262CI / V6**

TAPA

CAP

CALOTTA

TÊTE D'ALLUMEUR

REF	OEM
REC3854331	3854331



ROTOR

ROTOR

ROTORE

DOIGT D'ALLUMEUR

REF	OEM
REC3854311	3854311



CABLES

WIRE

CAVI

FAISCEAU

REF	OEM
REC15-601	





## V6 GXI

## TAPA

## CAP

## CALOTTA

## TÊTE D'ALLUMEUR

REF	OEM
REC898253T23	3859019



## ROTOR

## ROTOR

## ROTORE

## DOIGT D'ALLUMEUR

REF	OEM
REC898253013	898253013 3858977



## CABLES

## WIRE

## CAVI

## FAISCEAU

REF	OEM
REC15-606	

V8 DELCO EST  
VOLVO GM V8

## TAPA

## CAP

## CALOTTA

## TÊTE D'ALLUMEUR

REF	OEM
REC3854548	3854548



## ROTOR

## ROTOR

## ROTORE

## DOIGT D'ALLUMEUR

REF	OEM
REC3854549	3862014



## CABLES

## WIRE

## CAVI

## FAISCEAU

REF	OEM
REC15-804	



## V8 GXI

## TAPA

## CAP

## CALOTTA

## TÊTE D'ALLUMEUR

REF	OEM
REC898253T22	3858975



## ROTOR

## ROTOR

## ROTORE

## DOIGT D'ALLUMEUR

REF	OEM
REC898253013	898253013 3858977



## CABLES

## WIRE

## CAVI

## FAISCEAU

REF	OEM
REC15-815	

V8 FORD  
FORD 5.0L / 302CI EFI & 5.8L / 351CI EFI  
(1993-96)

## TAPA

## CAP

## CALOTTA

## TÊTE D'ALLUMEUR

REF	OEM
REC3854217	3854217



## ROTOR

## ROTOR

## ROTORE

## DOIGT D'ALLUMEUR

REF	OEM
REC3854218	3854218





## DISTRIBUIDORES



## DISTRIBUTORS

## SPINTEROGENI



## ALLUMEURS

REF	OEM		
REC807964A1		V6 (modelo antiguo HEI   late model HEI   modello vecchio HEI   modèle ancien HEI) 4.3 GL, GXI-A	REC15-601

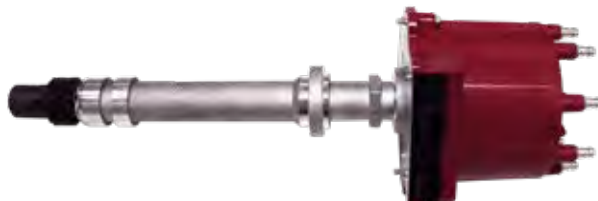

REF	OEM		
REC805222A1	3857449	V8 (modelo antiguo HEI   late model HEI   modello vecchio HEI   modèle ancien HEI) 5.0, 5.7 GL, GS, GXI-A 7.4GII, GS	REC15-804



REF	OEM		
REC817377		3.0 GL, GS Delco	REC15-405



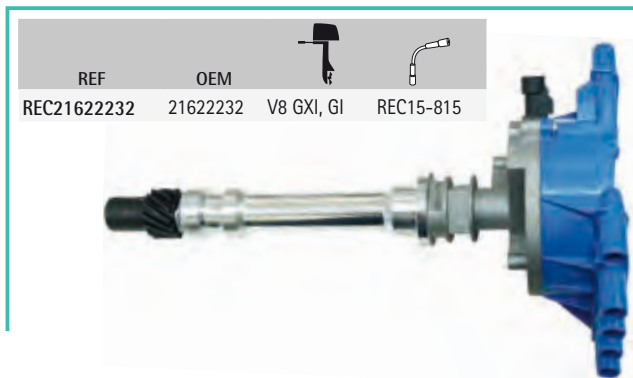
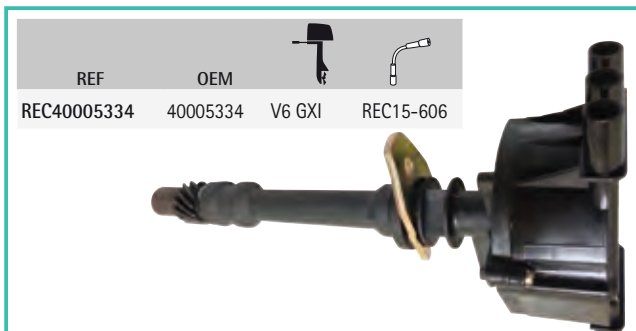

### KITS DE CONVERSIÓN ELECTRÓNICO

Sustituyen condensadores y contactos por componentes electrónicos.  
Usa bobina, tapa y rotor estándar.  
De fácil instalación, una pieza y dos cables.  
Precisión entre 1/4" calibrado de 0 a 8000 rpm.

### ELECTRONIC CONVERSION KITS

To substitute condensers for electronic devices  
Uses standard coil, cap & rotor  
Easy installation; one piece, two cables.  
Precisely calibrated between 1/4" from 0 to 8000

### KIT DI CONVERSIONE ELETTRICO

Sostituisce condensatori e contatti per componenti elettronici.  
Utilizza bobina, calotta e rotore standard.  
Facile installazione, una pz e due cavi.  
Precisione 1/4" calibrato da 0 a 8000.

### KITS DE CONVERSION ÉLECTRONIQUE

Remplace les condensateurs et les vis platinées par des composants électroniques. Utilisez une bobine, un t<sup>te</sup> et un rotor standard. Installation facile, une seule pièce et deux fils. Précision de 1/4" calibrée de 0 à 8000 rpm.

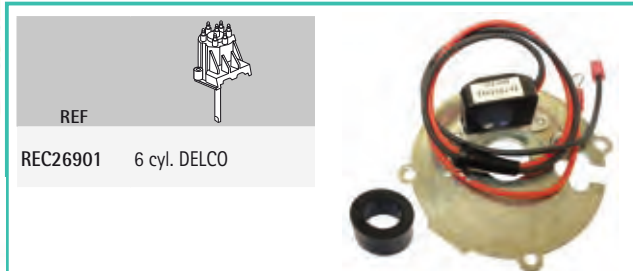

**DELCO®**  
**(4, 6, 8 CYL GM)**

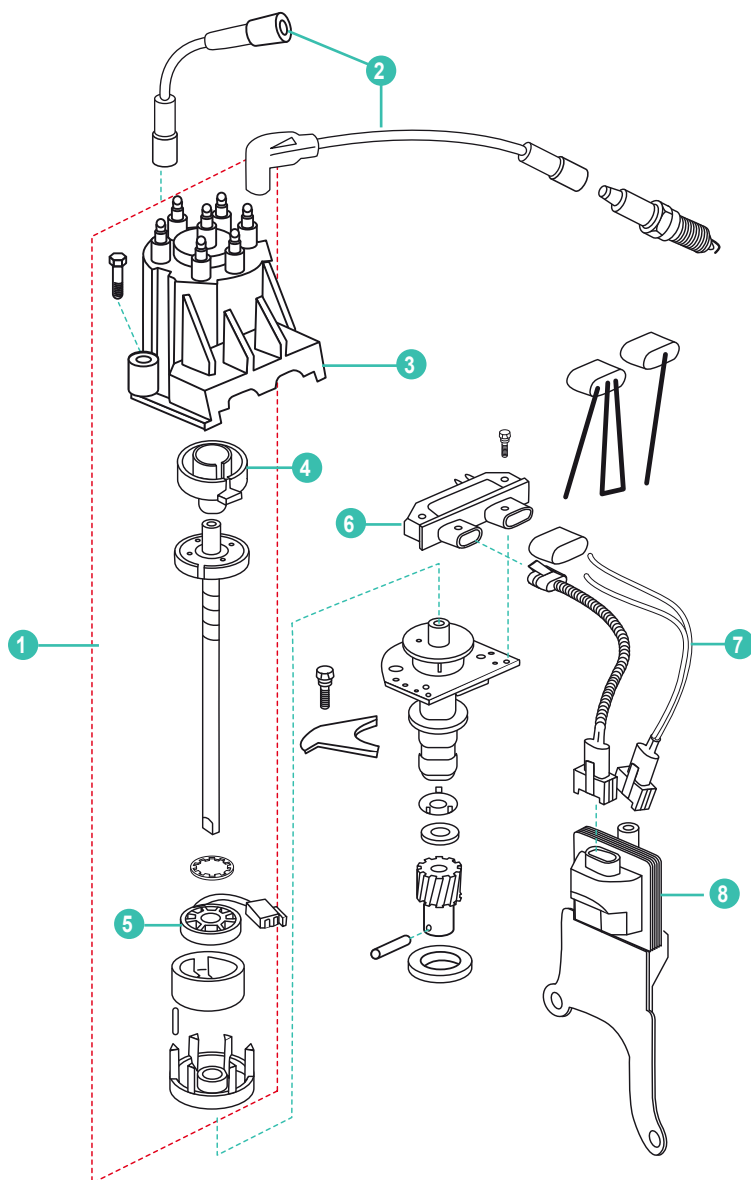

	REF	OEM				
	REC817377	817377	DISTRIBUIDOR 4 CYL	DISTRIBUTOR 4 CYL	DISTRIBUTORE 4 CYL	DISTRIBUTEUR 4 CYL
1	REC807964A1	807964A1	DISTRIBUIDOR 6 CYL	DISTRIBUTOR 6 CYL	DISTRIBUTORE 6 CYL	DISTRIBUTEUR 6 CYL
	REC805222A1	805222A1	DISTRIBUIDOR 8 CYL	DISTRIBUTOR 8 CYL	DISTRIBUTORE 8 CYL	DISTRIBUTEUR 8 CYL
	REC15-405	3888324	KIT CABLE ARRANQUE: 3.0L	IGNITION WIRE SET: 3.0L	KIT CAVI INIEZIONE: 3.0L	KIT FAISCEAU DE BOUGIE 3.0L
2	REC15-601	3888325	KIT CABLE ARRANQUE: V6	IGNITION WIRE SET: V6	KIT CAVI INIEZIONE: V6	KIT FAISCEAU DE BOUGIE V6
	REC15-804	3888326	KIT CABLE ARRANQUE: V8	IGNITION WIRE SET: V8	KIT CAVI INIEZIONE: V8	KIT FAISCEAU DE BOUGIE V8
	REC3854260	3854260	TAPA 4 CYL	CAP 4 CYL	COPERCHIO 4 CYL	TETE D'ALLUMEUR 4 CYL
3	REC3854331	3854331	TAPA 6 CYL	CAP 6 CYL	COPERCHIO 6 CYL	TETE D'ALLUMEUR 6 CYL
	REC3854548	3854548	TAPA 8 CYL	CAP 8 CYL	COPERCHIO 8 CYL	RETE D'ALLUMEUR 8 CYL
	REC3854311	3854311	ROTOR V6	ROTOR V6	ROTORE V6	DOIGT D'ALLUMAGE V6
4	REC3854549	3854549	ROTOR V8	ROTOR: V8	ROTORE: V8	DOIGT D'ALLUMAGE V8
	REC3854261	3854261	ROTOR 4 CYL	ROTOR 4 CYL	ROTORE 4 CYL	DOIGT D'ALLUMAGE 4 CYL
5	REC3854001	3854001	MÓDULO IMPULSOS	MODULE	MODULO	MODULE
6	REC3854003	3854003	MÓDULO DISTRIBUIDOR	MODULE: DISTRIBUTOR	MODULO DISTRIBUZIONE	MODULE DISTRIBUTEUR
7	REC500442		CABLE: DISTRIBUIDOR - BOBINA	WIRE LEAD: DIST- COIL	CAVO: DISTRIBUZIONE - BOBINA	FAISCEAU: DISTRIBUTEUR - BOBINE
8	REC500442	3854002	CABLE: BOBINA	WIRE LEAD: COIL HARNESS	CAVO BOBINA	FAISCEAU POUR BOBINE
9	REC84-817376T01	3854084	CABLES: BOBINA A DISTRIBUIDOR	CABLES: BOBINA A DISTRIBUIDOR	KIT CAVI BOBINA+FILTRO	FAISCEAU POUR BOBINE / DISTRIBUTEUR
10	REC294005		CABLE INTERRUPTOR	IGNITION WIRE: SHIFT INTERUPTEUR	CAVO INTERRUPTORE	FAISCEAU POUR SHIFT INTERRUPTEUR
11	REC91-888863	885163	HERRAMIENTA: DISTRIBUCIÓN, DELCO HEI/EST	TOOL:TIMING, DELCO HEI/EST	ATREZZI :TIMING, DELCO HEI/EST	OUTIL: ALLUMAGE DELCO HEI/EST



MPI V6 & V8  
(GM)

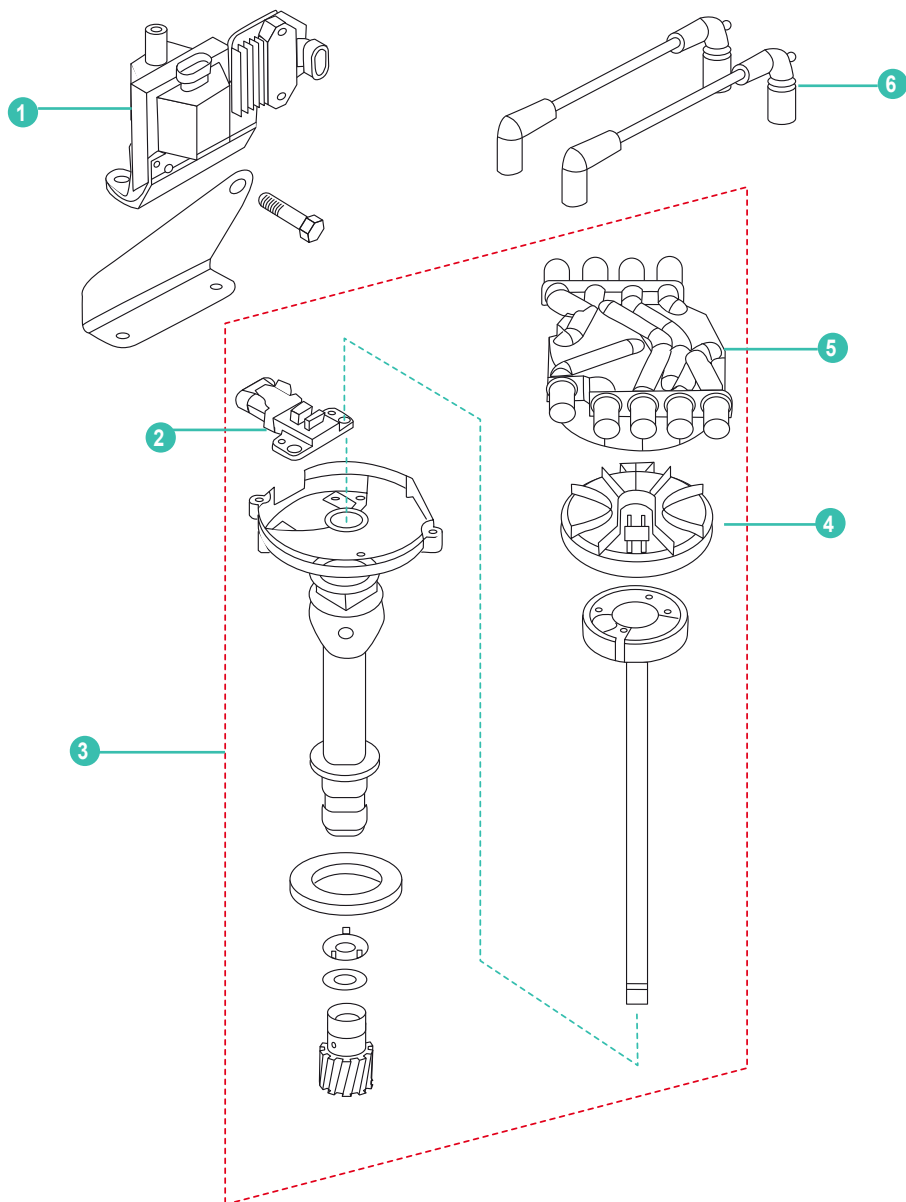

	REF	OEM				
1	REC3861985	3861985	BOBINA ENCENDIDO	IGNITION COIL	BOBINA INIEZIONE	BOBINE D'ALLUMAGE
2	REC3863130	3863130	SENSOR POSICIÓN ÁRBOL DE LEVAS	POSITION SENDER CRANKSHAFT	SENSORE POSIZIONE ALBERO A CAMME	SONDE DE POSITION D'ARBRE À CAMES
3	REC40005334	40005334	DISTRIBUIDOR V6	DISTRIBUTOR V6	DISTRIBUTORE V6	DISTRIBUTEUR V6
	REC21622232	21622232	DISTRIBUIDOR V8	DISTRIBUTOR V8	DISTRIBUTORE V8	DISTRIBUTEUR V8
4	REC898253013	3858977	ROTOR	ROTOR	ROTORE	DOIGT D'ALLUMAGE
5	REC898253T23	3859019	TAPA V6	CAP V6	COPERCHIO V6	TETE D'ALLUMEUR V6
	REC898253T22	3858975	TAPA V8	CAP V8	COPERCHIO V8	TETE D'ALLUMEUR V8
	REC15-606	3888327	KIT CABLES V6	WIRES KIT V6	KIT CAVI V6	FAISCEAU DE BOUGIE V6
6	REC15-815	3888328	KIT CABLES V8 (5.0L, 5.7L)	WIRES KIT V8 (5.0L, 5.7L)	KIT CAVI V8 (5.0L, 5.7L)	FAISCEAU DE BOUGIE V8 (5.0L, 5.7L)

# SISTEMA DE REFRIGERACIÓN COOLING SYSTEM

# SISTEMA DI RAFFREDDAMENTO SYSTÈME DE REFROIDISSEMENT

TERMOSTATO

THERMOSTAT

TERMOSTATO

THERMOSTAT

SISTEMA DE TERMOSTATO  
D31/D41/D42/D43/D44/D300

THERMOSTAT SYSTEM  
D31/D41/D42/D43/D44/D300

SISTEMA DE TERMOSTATO  
D31/D41/D42/D43/D44/D300

SYSTÈME DE THERMOSTAT  
D31/D41/D42/D43/D44/D300

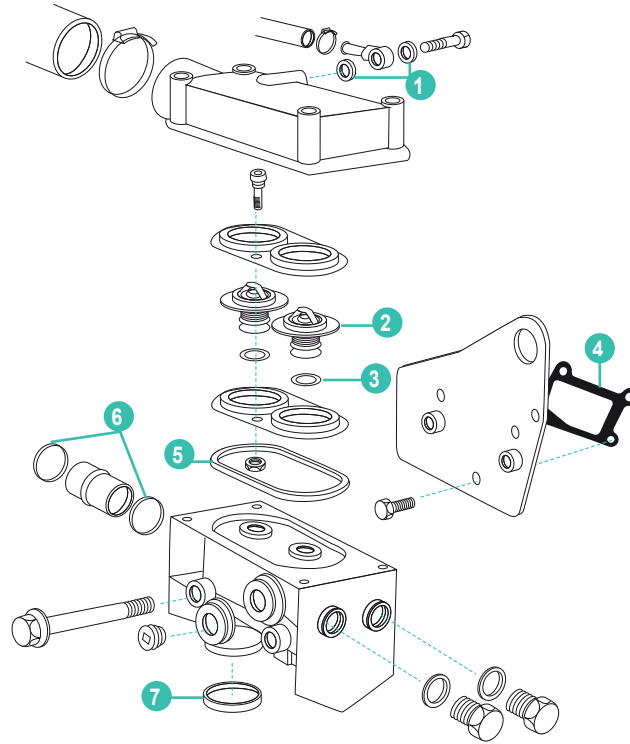



	REF	OEM				
1	REC11994	110386	ARANDELA	WASHER	RONDELLA	RONDELLE
		11994				
		18839				
		233033				
		243621				
		3580629				
		6603088				
		6604939				
		859851				
		859853				
2	REC3831424	861835	TERMOSTATO	THERMOSTAT	TERMOSTATO	THERMOSTAT
		3831424				
		875849				
		876128				
		889425				
3	REC416033	1317466	JUNTA	GASKET	GUARNIZIONE	JOINT DE THERMOSTAT
		416033				
		418361				
4	REC1542187	1542187	JUNTA	GASKET	GUARNIZIONE	JOINT
5	REC838807	838807	ARO TÓRICO	O'RING	O'RING	JOINT TORIQUE
6	REC968927	968927	ARO TÓRICO	O'RING	O'RING	JOINT TORIQUE
7	REC3583913	1542198	ARO TÓRICO	O'RING	O'RING	JOINT TORIQUE
		3583913				

**CUERPOS TERMOSTATO****THERMOSTATO HOUSING****CORPO TERMOSTATO****CORPS DE THERMOSTAT**

REF	OEM	
REC3850360	3850360	V6 & V8 (1993-11)



**KITS TERMOSTATO****THERMOSTATO KIT****KIT TERMOSTATO****KITS THERMOSTAT**

REF	OEM		°C
REC876080	876080		60 °C
	876797		
	875781		
	875790		
	824912		
	82812		



REF	OEM		°C
REC875791	875791	AQ165A	55 °C
	831040	AQ170A, B, C	
		BB165, 170	





REF	OEM		°C
REC875580	AQ120B		82 °C
	AQ125A, B		
	AQ131A, B, C, D		
	AQ140A		
	AQ145A, B		
	AQ151A, B, C		
	AQ171A, C		
	230A		
	250A		
	251A, B		
	BB140		



REF	OEM		°C
REC3853799	3853799		71 °C





REF	OEM		°C
REC876305	876305		62 °C
	875794		
	424299		
	835177		
	V6 & V8 (antiguos   all old style   vecchi   anciennes)		





REF	OEM		°C	Ø THERMO.
REC3853983	3853983		60 °C	38 mm



REF	OEM		°C
REC3587597	3587597		66 °C
	4.3GL-B, C, E		
	4.3GXi-F, Si-F		
	5.0GL-F, C, D		
	5.0GXi-F, OSi-F		
	5.7GL-C, D		
	5.7Gi-F, OSi-E, GXi-G, OSXi-E		
	5.7GiL-F, G		
	V6-200, 225		
	V8-225, 270, 300, 320, 380		





REF	OEM		°C	
REC3856961	3856961		70 °C	
				4.3 GL, GS, Gi, GXi-B, GXi-BF
				5.0 FL, Fi, Gi, GL
				5.7 GL, Gi, GS, GSi, GSX
				5.8 FL, Fi, FSi
8.1 Gi, GSi, GXi, OSi				



REF	OEM		°C
REC875796	875796	MB10A	60 °C



REF	OEM		°C	
REC3831426	3831426 875788 824200		70 °C	
				V8, D40
				5.0GXi-EF, 00Si-EF
				8.1GXi A, B, C
				8.1GXi AF, BF, CF
				8.1GXiL-A, B, C
				8.1GiA, B, C, D
				8.1Gi-BF, CF, DF
				8.1GiL-A, B, C, D



**KITS TERMOSTATO****THERMOSTATO KIT****KIT TERMOSTATO****KITS THERMOSTAT**

REF	OEM		°C
REC876080	876080 876097	MD2A, B MD3B MD11C, D MD17C, D	60 °C



REF	OEM		°C
RM6210419	6210419	MD22A, L-A, L-B, P-B TMD22A, B, P-C TAMD22P-B	



REF	OEM		°C
REC875796	875796	MD6A, B MD7A, B	60 °C



REF	OEM		°C
REC3831426	3831426	MD31A (versión antigua   old style   versione vecchia   version ancienne) MD40A MD41A (versión antigua   old style   versione vecchia   version ancienne) (Se necesita 1 pieza   1 piece needed   Ne serve 1 pz   1 pièce est nécessaire)	70°C

REF	OEM		°C	CIRCUITO CERRADO FRESH WATER CIRCUIT CIRCUITO APERTO CIRCUIT FERME
REC877355	877355	2001AG, B, BG 2002AG, B, BG, D	62 °C	X
RM875795	875795	2003AG, B, BG, D, T, TB	74 °C	✓



REF	OEM		°C
REC875783	875783	MD5A, B, C	60 °C



REF	OEM		°C
REC3831424	3831424	MD31 / MD41 (Versión moderna   New style   versione moderna   version moderne) KAD32, 42, 43, 44, 300	81°C



REF	OEM		°C
RM861911	861911	2010A, B, C, D 2020A, B, C, D	75°C



REF	OEM		°C
REC3831425	3831425	MD30A (Se necesitan 2 piezas   2 pieces needed   Ne serve 2 pz   2 pièces sont nécessaires) MD40A (Se necesita 1 pieza   1 piece needed   Ne serve 1 pz   1 pièce est nécessaire)	76°C



REF	OEM		°C
RM3580365	3580365	D2-55A, B MD2030A, B, C, D MD2040A, B, C, D	82°C



REF	OEM		°C
REC3839110	3839110	TAMD61, 62, 63, 71, 72, 73, 74-P 162C, 163A-A, 163P-A	75°C

REF	OEM		°C	CIRCUITO CERRADO FRESH WATER CIRCUIT CIRCUITO APERTO CIRCUIT FERME
REC877349	877349	MD11C, D MD17C, D	74 °C	✓

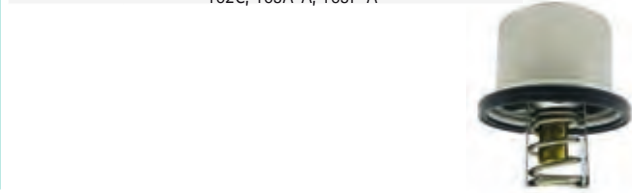



REF	OEM		°C
RM3842015	3842015	D1-13A, B, F D1-20A, B, F D1-30A, B, F D2-40A, B, F	90°C







REF	OEM		°C
RM888624	888624	D1-20A, B, F D2-50F D2-55C, D, F D2-75A, B, C, F D2-60F	83°C





REF	OEM		°C
RM21412646	21412646	D9A2	86°C





REF	OEM		°C
REC3840816	3840816	D3 110 --> D3 220HP	79°C



REF	OEM		°C
REC21412639	21412639	D9A2, A-MG D12C-A, D-A, D-B, D-G, D-H (MP) D13B-A, B-B, B-C, B-D, B-E, B-G, G-H (MP)	82°C





REF	OEM		°C
REC8149182	8149182	D4, 6, TAMD63L-A, P-A TAMD122A, P-A, P-C TMD122A, P-B	82°C



REF	OEM		°C
REC876080		AQD2B MD2B, 3B MD11C, D MD17C, D	60°C



REF	OEM		°C
RM3588437	3588437	D4, 6 INTERCOOLER	82°C



REF	OEM		°C
REC20450736	20450736	D5A-A TA, A-B TA D7A-B TA, C-B TA, C-A TA TD420VE TAD420VE, 620VE, 650VE, 660VE, 750VE, 760VE	82°C



REF	OEM		°C
REC875785	875785	MD19, 27, 29A, 32A MD21A, B AQD19, 27, 29A, 32A AQD21A, B	71 °C





**RETÉN SOPORTE DOBLE  
TERMOSTATO**

**DOUBLE THERMOSTAT  
SUPPORT GASKET**

**PARAOLIO SUPPORTO,  
TERMOSTATO DOPPIO**

**JOINTS DU SUPPORT  
DOUBLE DE THERMOSTAT**

REF	OEM	
REC838807	838807	D31/D41/D42 /D43/D44 D13/D300



*new*

JUNTAS TERMOSTATO

THERMOSTAT GASKET

GUARNIZIONE TERMOSTATO

JOINTS DE THERMOSTAT

REF	OEM		
REC27-33918	835417 3852111		

REF	OEM	3.0L		
REC27-8146801	3852096			

REF	OEM		
REC835581	835581		

REF	OEM		
REC0307239	3852071		

REF	OEM		
REC856004	856004		

REF	OEM	MD2040A, B, C, D D2-55, B, C, D, E, F		
REC3583780	3583780			

REF	OEM	30, 31, 32, 40, 41, 42, 43, 44, 300		
REC1542187	1542187			

REF	OEM	MD2040A, B, C, D D2-50F D2-55, B, C, D, E, F		
REC3580514	3580514			

REF	OEM		
REC416033	416033 7416033		<b>new</b>

INTERCAMBIADOR DE CALOR

HEAT EXCHANGER

SCAMBIATORE DI CALORE

ÉCHANGEUR DE CHALEUR

KITS INTERCAMBIADOR

HEAT EXCHANGER KITS

KIT SCAMBIATORI

KITS JOINTS D'ÉCHANGEUR

REF		
REC23011	D2-55A, B	

REF		
REC23013	D3-110I-A, I-B, I-C D3-130A-A, A-B, A-C, I-A, I-B, I-C D3-160A-A, A-B, A-C, I-A, I-B, I-C D3-190A-B, A-C, I-B, I-C	

REF		
REC23012	D2-55C, D, F D2-75A, B, C, F	

REF		
REC23048	D4-180I-F, I-B, I-C, I-D, I-E D4-210A-A, I-A, I-B D4-225A-F, I-F, A-B, I-B, A-C, A-D, I-C, I-D, A-E, I-E D4-260A-F, D-F, I-F, A-A, A-B, A-C, A-D, D-B, D-C, D-D, I-A, I-B, I-C, I-D, D-E, I-E, A-E D4-300A-F, D-F, I-F, A-A, A-C, A-D, D-A, D-C, I-A, I-C, I-D, A-E, D-E, D-D, I-E D6-280A-A, A-B, A-C, A-D, A-E, I-A, I-B, I-C, I-D, I-E D6-310I-A, A-A, A-B, A-C, A-D, D-B, D-C, D-D, I-B, I-C, I-D, A-E, D-E, I-E D6-330A-B, A-C, A-D, D-B, D-C, D-D, I-B, I-C, I-D, A-E, D-E, I-E D6-350A-A, A-B D6-370A-B, A-C, A-D, D-B, D-C, D-D, I-A, I-B, I-C, I-D, A-E, D-E, I-E D6-400A-E D6-435D-A, D-D, D-C, D-E, I-A, I-C, I-D, I-E	

REF		
REC23048	D4-180I-F, I-B, I-C, I-D, I-E D4-210A-A, I-A, I-B D4-225A-F, I-F, A-B, I-B, A-C, A-D, I-C, I-D, A-E, I-E D4-260A-F, D-F, I-F, A-A, A-B, A-C, A-D, D-B, D-C, D-D, I-A, I-B, I-C, I-D, D-E, I-E, A-E D4-300A-F, D-F, I-F, A-A, A-C, A-D, D-A, D-C, I-A, I-C, I-D, A-E, D-E, D-D, I-E D6-280A-A, A-B, A-C, A-D, A-E, I-A, I-B, I-C, I-D, I-E D6-310I-A, A-A, A-B, A-C, A-D, D-B, D-C, D-D, I-B, I-C, I-D, A-E, D-E, I-E D6-330A-B, A-C, A-D, D-B, D-C, D-D, I-B, I-C, I-D, A-E, D-E, I-E D6-350A-A, A-B D6-370A-B, A-C, A-D, D-B, D-C, D-D, I-A, I-B, I-C, I-D, A-E, D-E, I-E D6-400A-E D6-435D-A, D-D, D-C, D-E, I-A, I-C, I-D, I-E	

REF 

REC23015 D1-13A, B, F  
D1-20A, B, F  
D1-30A, B, F



REF 

REC22032 Para circuito de agua dulce  
Fresh water cooling system  
Per circuito acqua dolce  
Pour circuit d'eau douce  
2002, 2003 AG, B, BG



REF 

REC22155 D22  
MD22A, L-A



REF 

REC22033 Para circuito de agua dulce  
Fresh water cooling system  
Per circuito acqua dolce  
Pour circuit d'eau douce  
2003T, TB



REF 

REC22077 D22  
MD22L-B, P-B



REF 

REC22122 MD21A



REF 

REC22156 D22  
TMD22A



REF 

REC22123 AOD21A  
MD21B



REF 

REC22148 D22  
TMD22B  
TAMD22P-B

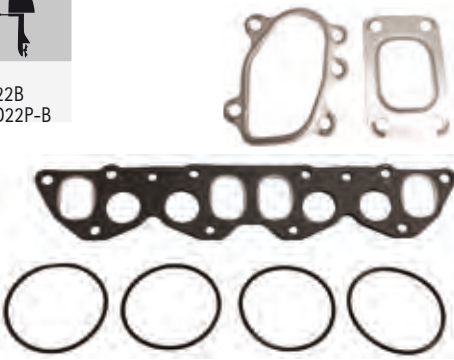

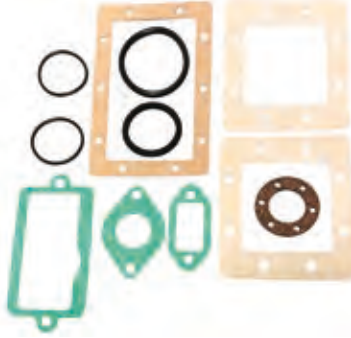

REF 

REC22124 AOD29, A  
AOD32A  
MD29, A  
MD32A



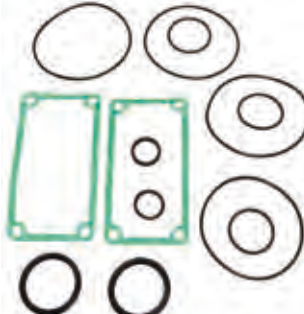

REF	
MD30 TMD30A REC22105 TAMD30A AD30A AQAD30A	





REF	
AQD40B TMD40B, C REC22107 AQAD40A, B TAMD40A, B	





REF	
MD40A TMD40A REC22106 AQD40A	



REF	
TMD31A, 31B, 41B TAMD31A, 31B, 41B REC22108 AD31A, 31B, 41B D41B, A	



REF	
TMD31L-A, 41L-A TAMD31P-A, L-A, M-A TAMD41P-A, L-A, M-A, H-A AD31P-A, L-A AD41P-A, L-A REC22109 D41L-A KAD32P, P-A KAD43P, P-A KAD44P, P-A, P-B, P-C KAD300A KAMD300A	





JUNTAS INTERCAMBIADOR

HEAT EXCHANGER GASKETS

GUARNIZIONE SCAMBIATORI



JOINTS D'ÉCHANGEUR

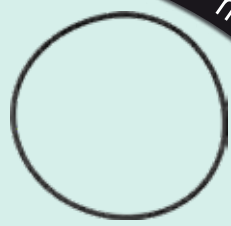

REF	OEM				new
REC976051	976051	D4/D6	49.2 x 5.7 mm		

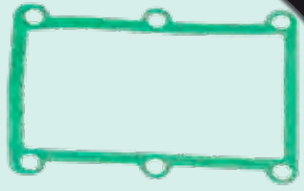
tubo de agua  
water tube  
tubi acqua  
tube d'eau

REF	OEM			new
REC3583647	3583647	D4/D6		

REF	OEM			new
REC859061	859061 842669	AQD40A MD40A TMD40A		

REF	OEM			new
REC855405	855405	230/250/251 AQ131/AQ151/AQ171		

REF	OEM			new
REC964106	964106	D31, D41, D32, D42, D43, D44, D300, D13, D4, D6, D8, D122		

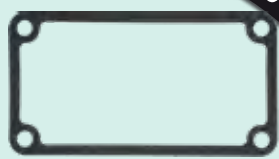
REF	OEM			new
REC859045	859045 845291	D30/D40		

tapa superior  
upper cover  
copperchio superiore  
couvercle supérieur



INTERCOOLER

INTERCOOLER

INTERCOOLER

INTERCOOLER

REF	OEM	
REC859047	859047 845585	D40

Tapa lateral  
Side cover  
Coperchio laterale  
Couvercle lateral



REF	
REC22103	AQ120B, 125, 140, 145 BB140A, 145A



REF	
REC22015	AQ131,151,171 230, 250, 251



INTERCAMBIADOR DE AGUA

WATER EXCHANGER

SCAMBIATORE ACQUA

ÉCHANGEUR D'EAU



REF
REC22037

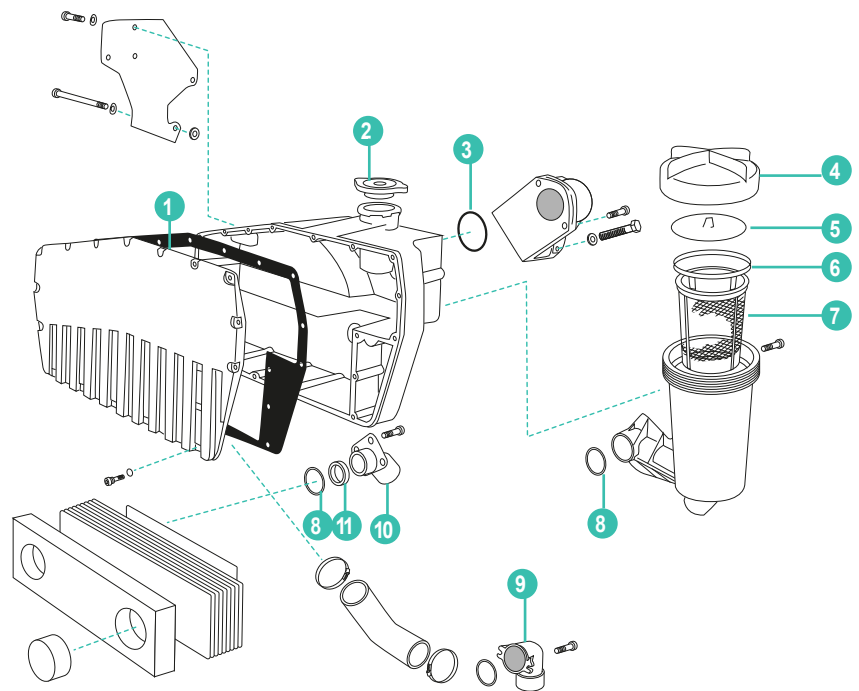

	REF	OEM				
1	REC855405	855405	JUNTA	GASKET	GUARNIZIONI	JOINT
2	RM829205	818666 829205	TAPON	CAP	TAPPO	BOUCHON
3	REC975672	925091 975672	ARO TORICO	RUBBER O-RING	FASCIA TONDA	JOINT TORIQUE
4	RM855410	855410	TAPA	COVER	COPERCHIO	COUVERCLE
5	RM855433	855433	TAPA PRESION	PRESSURE PLATE	COPERCHIO PRESSIONE	PLATEAU DE PRESSION DU FILTRE A EAU
6	RM855423	855423	JUNTA	GASKET	GUARNIZIONI	JOINT DE COUVERCLE DU FLTRE A EAU
7	RM855409	855409	FILTRO	STRAINER	FILTRO	FILTRE
8	REC948610	925067 948255 948610	ARO TORICO	O-RING	FASCIA TONDA	JOINT TORIQUE
9	RM855791	831931 855791	CONECTOR CAJA	CONNECTOR	CONNETTORE	RACCORD
10	RM856083	855407 856083	CONECTOR	CONNECTING PIPE	CONNETTORE	PIPE DE CONNEXION
11	REC855582	825582	ANILLO RETEN	O-RING	FASCIA TONDA	JOINT TORIQUE

FILTRO AGUA SALADA

SEA WATER FILTER

FILTRO ACQUA SALATA

FILTRE EAU DE MER

REF	OEM		
REC3583840	3583840 21219693	2001, 2002, 2003, 2010, 2020, 2030, 2040 MD AQD21, 30, 31, 41, D1, 2	Ø32 mm



REF	OEM	
REC21655254	21655254	Ø 50 mm
	21610728	
	3594159	
	3809093	
	3594161	
REC21880386	3809097	
	3587046	
	21880386	
	21641712	
	860631	



REF	OEM	
REC21457172	21457172	D4 & D6 (con cola   with sterndrive   con piede   avec embase)
	3889148	
	3809070	
	3582986	
	3809071	
	3583338	



ENFRIADOR DE AIRE

AFTERCOOLER

REFRIGERATORE ARIA

REFROIDISSEUR D'AIR

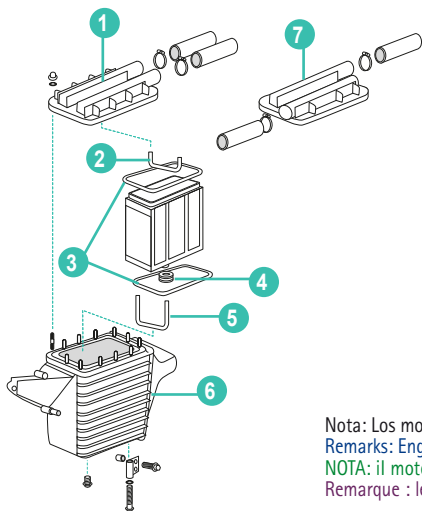

Nota: Los motores 44 y 300 utilizan la misma carcasa pero diferente elemento y tapa.  
 Remarks: Engines 44 & 300 uses same housing but different insert and cover.  
 NOTA: il motori 44 e 300 montano la stessa carcassa, ma differente elemento e coperchio.  
 Remarque : les moteurs 44 et 300 utilisent le même boîtier mais un élément et un couvercle différents.

	REF	OEM				
1	RM860409	860409	TAPA	COVER	COPERCHIO	COUVERCLE
2	REC847573	847573	JUNTA	GASKET	GUARNIZIONE	JOINT
3	REC860920	860920	JUNTA	GASKET	GUARNIZIONE	JOINT
4	REC858979	858979	JUNTA	GASKET	GUARNIZIONE	JOINT
5	REC3582639	3582639	JUNTA	GASKET	GUARNIZIONE	JOINT
6	RM861657	861657	CARCASA	HOUSING	CARCASSA	CARTER
7	REC861263	861263	TAPA 44/300	COVER 44/300	COPERCHIO 44/300	COUVERCLE 44/300

**JUNTAS ENFRIADOR**

**AFTERCOOLER GASKETS**

**GUARNIZIONE REFRIGERATORE**

**JOINTS DE REFFROIDISEUR**

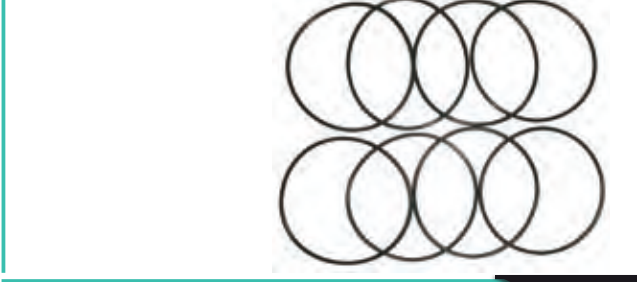
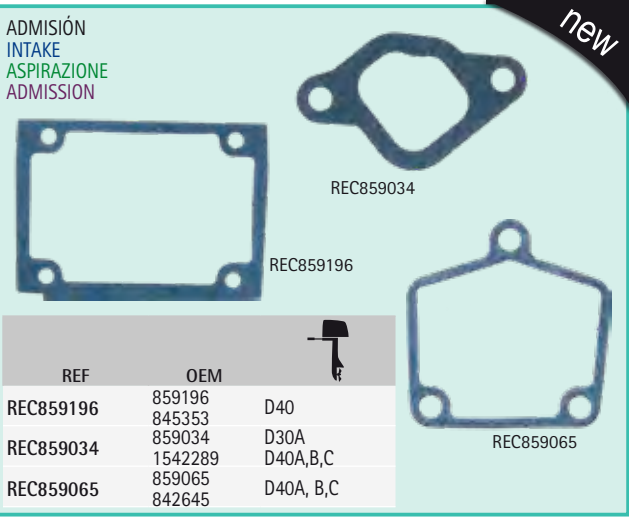
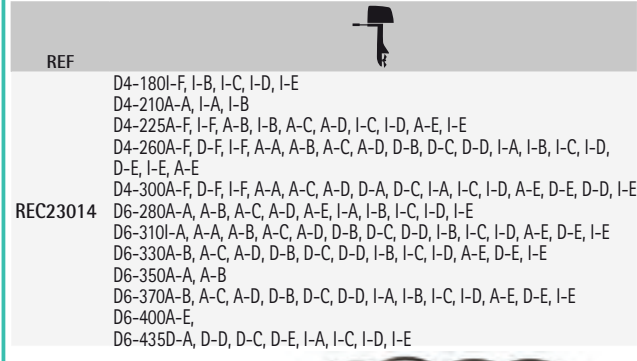
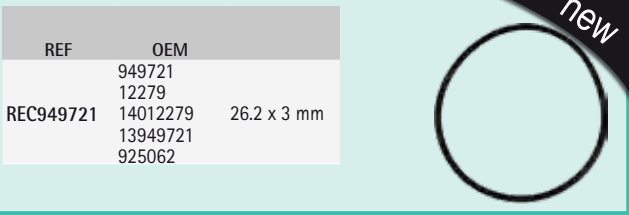
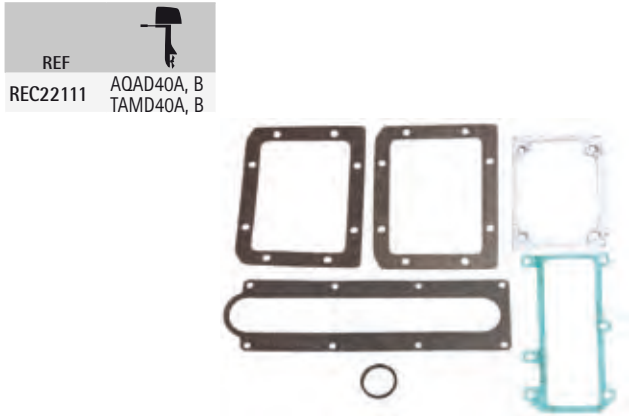

**ENFRIADOR DE ACEITE**

**OIL COOLER**

**SCAMBIATORE OLIO**

**REFROIDISEUR D'HUILE**

**CARCASA**

**HOUSING**

**CARCASSA**

**CARTER**

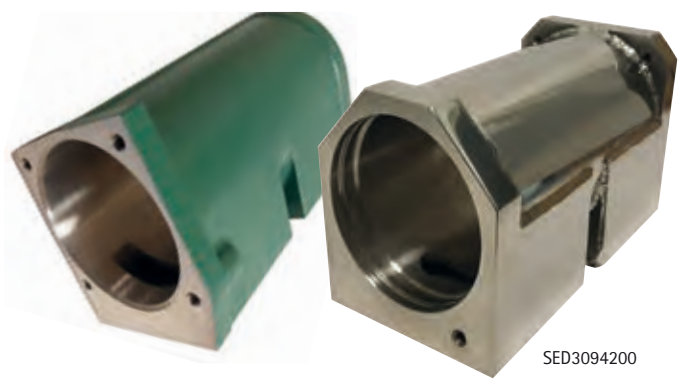



**KIT RETENES ENFRIADOR OIL COOLER SEAL KIT DE ACEITE**

REF	
REC22070	AQ105, 115, 120, 130, 145, 151, 165A, 170, 171 BB115, 140, 145, 165, 170 MB20A, B, C 230A, B 250A, B 251A

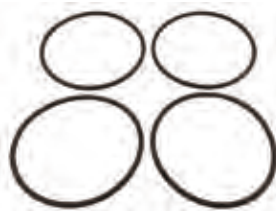

REF	
REC22153	D22 MD22L-B, P-B TAMD22P-B TMD22B



REF	
REC22152	D22, 30, 31, 32, 40, 41, 42, 43



REF	
REC22022	Con circuito de agua dulce With fresh water cooling system Con circuito ad acqua dolce Avec circuit d'eau douce 2003T, TB



**KIT TENUTE REFRIGERATORE OLIO**

REF	
REC22128	MD29, 29A 32A AQD29A, 32A



REF	
REC22127	MD21A, B AQD21A, B



REF	
REC22143	Para tapa de enfriador con 3 tornillos 3 bolt oil cooler cap Per modello con 3 viti couvercle avec 3 vis
	KAD32P-A, 42P-A, 43P-A, 44P-A, 300A KAMD42P-A, 43P-A, 44P-A, 300A TAMD42WJ-A D31, 32, 41, 42, 43, 44, 300



REF	
REC22104	Para tapa de enfriador con 4 tornillos 4 bolt oil cooler cap Per modello con 4 viti couvercle avec 4 vis
	MD30, 31, 40, 41, 42, 43, 44, 300

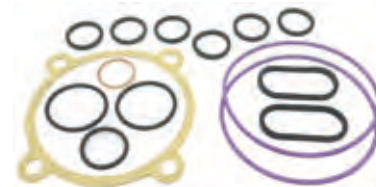



REF	
REC22149	D30, 31, 32, 40, 42, 43 D41, A, B, D, L-A AD30A, 40B AD31A, B, D, L-A, P-A, XD AD41AM, L-A, P-A AQAD30A, 31A, 40A, 41A AQD40AM MD30AM, 31, 40A TAMD30A, 40A, 42B, 42WJ-A TAMD31A, L-A TAMD41A, B, D, H-A, L-A, M-A, P-A TMD30A, 31A, 40A TMD41A, B, D, L-A KAD32P-A, 43P-A, 300A KAD42A, B, P-A KAD44P-A, P-B, P-C KAMD42A, B, P-A KAMD43P-A, 300A KAMD44P-A, P-B, P-C KAD44P-A, P-B, P-C





**RETENES Y JUNTAS**      **OIL SEAL & GASKETS**      **PARAOILIO E O-RING**      **JOINTS SPI ET TORIQUES**

new

REF	OEM		 (mm)				
REC976041	976041	D4/D6	42.2 x 3				
REC949974	94997		27.2 x 3				
REC976106	976106 190187 949721 12279						
REC949721	14012279 13949721 925062		26.2 x 3 mm				
REC975309	975309	D4/D6 D162/D163	38.2 x 32.2 x 3				
REC859086	859086 842586	D31/D41/D30/D40/D32/D42/ D43/D44 D13					
REC949722	949722 13949722	D4/D6 D162/D163/D165 D61/D62/D63/71/72 D73/D74/D75	36.2 x 3	ENFRIADOR ACEITE BOMBA ACEITE Y FILTRO	OILCOOLER OIL PUMP & FILTER	SCAMBIATORE OLIO POMPA OLIO E FILTRO	REFROIDISSEUR D'HUILE POMPE A HUILE ET FILTRE
REC969415	969415	D12/D13/D16/D5/9D7/D8/D9 D4/D6/D162/D103/D2010 D163/D74/D75	49.5 x 3	SISTEMA ACEITE Y REFRIGERACIÓN	OIL SYSTEM & COOLING	SISTEMA OLIO E SCAMBIATORE	SYSTÈME D'HUILE ET REFROIDISSEUR
REC949658	949658 12276		24.2 x 3	TUBO ENFRIADOR BOMBA AGUA INVERSORA	OILCOOLER TUBE WATER PUMP INVERTER	TUBO SCAMBIATORE POMPA ACQUA INVERSORA	TUYAU REFFROIDISSEUR, POMPE A EAU INVERSEUR REFROIDISSEUR D'HUILE
REC859010	859010 845301	MD40		ENFRIADOR ACEITE	OILCOOLER	SCAMBIATORE OLIO	REFROIDISSEUR D'HUILE
REC859131	859131 844084	D40A,B		COLECTOR ADMISIÓN	INTAKE MANIFOLD	COLLETTORE ASPIRAZIONE	CARTER ADMISSION

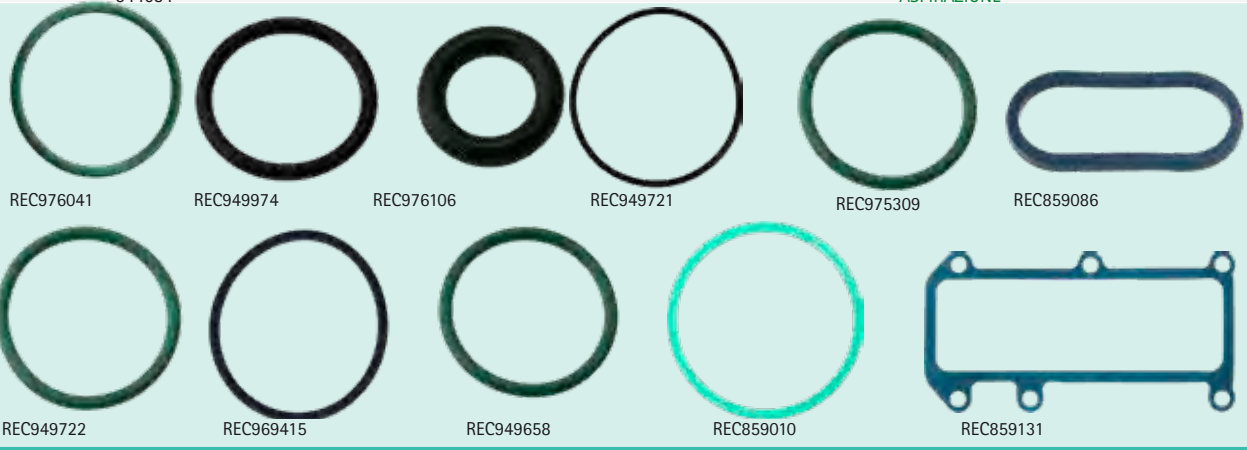

**BOMBAS DE AGUA DE CIRCULACIÓN**      **BLOCK CIRCULATING WATER PUMPS**      **POMPE ACQUA RICIRCOLO DI BLOCCO**      **POMPE DE BRASSAGE**



**BOMBAS DE AGUA**      **WATER PUMPS**      **POMPE ACQUA**      **POMPE A EAU**

REF	OEM	
REC271975	271975 1275148 3547560	131A, B, C, D 151A, B, C 171A, C 230A, B 250A, B 251A



REF	OEM		
REC46-8M0113733	3858340 3854017	3.0L	



REF	OEM	
REC3587508	3587508 828023	140A 120B 125A 145A



REF	OEM		
REC46-8M0113735	3855991 856609 3854118	7.4L 8.2L	





VOLVO

RECAMBIOS MARINOS

REF	OEM	
REC879194401	21124846	V6 (no bypass) 4.3L-J, GL-JF, GXI225-R, GI200-R, GXIE225-R, GXIE-M, GXIE-P, GXIE-Q, GXI-J, GXI-JF, OSI-V, OSI- JF, GXI-P, GXI-Q (2008+)





REF	OEM	
REC46-8M0113736	3861341	GM 8.1L



REF	OEM	
REC46-8M0113734	3853850	V6 Et V8 (bloque pequeño   small block   blocco piccolo   petit bloc) no : 4.3L-J, GL-JF, GXI225-R, GI200-R, GXIE225-R, GXIE-M, GXIE-P, GXIE-Q, GXI-J, GXI-JF, OSI-V, OSI-JF, GXI-P, GXI-Q (-2007)



REF	OEM	
REC3853796	3853796	V8 Ford, 302 et 351



JUNTAS BOMBAS DE AGUA

WATER PUMPS GASKETS

GUARNIZIONE POMPE DELL'ACQUA

JOINTS DE POMPE A EAU





REF	OEM		BOMBA PUMP POMPA POMPE
REC27-803192A2	24-803192A2	740, 7.4, 8.2L	REC46-8M0113735

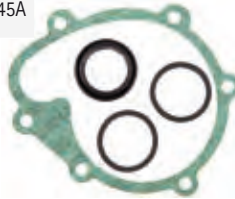

REF	OEM	
REC22014	AQ120B, 125A, 140A, 145A BB140A, 145A	



REF	OEM		BOMBA PUMP POMPA POMPE
REC27-56880	Ford V8 (302, 351)		REC3853796





REF	OEM	
REC22038	AQ125B, 145B	





REF	OEM		BOMBA PUMP POMPA POMPE
REC27-33956	3853342	4 Et 6 Cyl.	REC46-8M0113733





REF	OEM		BOMBA PUMP POMPA POMPE
REC3067767	3067767	D3	REC3801404





REF	OEM	
REC3818912	3818912	D4 D6



REF	OEM		BOMBA PUMP POMPA POMPE
REC27-34897	3852477	GM V6 Et V8 (bloque pequeño   small block   blocco piccolo   petit bloc)	REC46-8M0113734 REC879194401



REF	OEM		BOMBA PUMP POMPA POMPE
REC859027	859027 1542229		REC23059414



REF	OEM		BOMBA PUMP POMPA POMPE
REC27-49110	3853361	V-8 (big bloce   big block   blocco grande   big bloc)	REC46-8M0113735



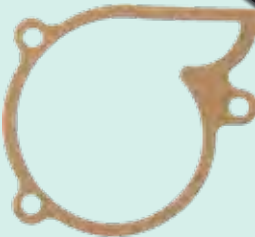

REF	OEM	
REC430017	430017	AQ165 AQ170 BB165 BB170



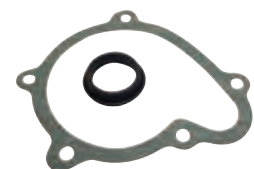

REF	
REC22039	AQ131A, B, C, D AQ151A, B, C AQ171A, C 230A, 250A, 251A



REF	OEM	
REC1378491	1378491 1376344	230,250,251 131,151,171



REF	
REC22013	AQ165A BB165A AQ170A, B, C BB170A, B, C



**GUÍA BOMBAS DE CIRCULACIÓN**      **WATER CIRCULATING PUMPS APPLICATION**      **GUIDA POMPA DI RICIRCOLO**      **GUIDE POMPES D'EAU**

	BOMBA PUMP POMPA POMPE	OEM	JUNTA BOMBA GASKET PUMP GUARN. POMPA JOINT POMPE	OEM	CUERPO TERMOS. THERMOS. HOUSING CORPI TERMOSTAT CORS THERMOSTAT	OEM	JUNTA CUERPO GASKET HOUSING GUARNI. CORPI JOINT DE CORPS	OEM	MANGUITO HOSE MANICOTTO DURITE	OEM
AQ131A, B, C, D AQ115A, B, C AQ171A, C 230A, B 250A, B 251A B21 B23 AQ120B AQ125A AQ140A BB140A AQ145A BB145A	REC271975	271975								
3.OGLMMDA, GSPMDA, GSMHUB, GSPHUB, GSMNCA, GSPNCA, GSMNCS, GSPNCS, GSMLKD, GSPLKG	REC46-8M0113733	3858340	REC27-33956	3853342	BAOMC29-910303	3854254	REC27-8146801	3852096	RM3852289	3852289
3.OGSP-A, -B, -C WTR, WTS, BYCCE, EFS GSM-A, -B, -C, WTR, WTS, BYMCE GLP-A, -B, -C, -D, -E, -J, -N GLM-A, -B, -C	REC46-8M0113733	3858340	REC27-33956	3853342			REC27-8146801	3852096	RM3857391	3857391

	BOMBA PUMP POMPA POMPE		JUNTA BOMBA GASKET PUMP GUARN. POMPA JOINT POMPE		CUERPO TERMOS. THERMOS. HOUSING CORPI TERMOSTAT CORS THERMOSTAT		JUNTA CUERPO GASKET HOUSING GUARNI. CORPI JOINT DE CORPS		MANGUITO HOSE MANICOTTO DURITE	
	REF	OEM	REF	OEM	REF	OEM	REF	OEM	REF	OEM
4.3GXIE-M, GL-P, GL-J, GL-JF, GXI-J, GXI-JF, GXI-P, GXI-Q, GXIE-P, GXIE-Q, GXI-225-R, GI-200-R, GXIE-225-R, OSI-J, OSI-JF V6-200-A V6-225-A, -E-A	REC879194401	21124846	REC27-34897	3852477			REC27-33918	3852111	REC3862523	3862526
V8 (bloque pequeño   small block   blocco piccolo   petit bloc) Et V6 ⊘ : 4.3GXIE-M, GL-P, GL-J, GL-JF, GXI-J, GXI-JF, GXI-P, GXI-Q, GXIE-P, GXIE-Q, GXI-225-R, GI-200-R, GXIE-225-R, Osi-J, Osi-JF V6-200-A V6-225-A, -E-A	REC46-8M0113734	3853850	REC27-34897	3852477	REC3850360	3850360	REC27-33918	3852111	RM3852288	3852288
8.1 GIE-P, -J, -K, -M, -JF, -KF, -MF GXIE-P, -J, -K, -M, -JF, -KF, -MF GICE-P, -Q IPSCE-PF, -Q, -JF, -MF IPSE-JF GI-A, -B, -C, -D, -E, -F, -J, J-F, -G, H, -J, -GF, -EF, -FF, -HF GSI-A GXI-A, -B, -C, -D, -E, -F, -G, -J, -JF, -DF, -EF, -FF, -GF Gil-A, -B, -C, -D, -E, -G, -H GSII-A GXII-A, -B, -C, -D, -E, -F, -G OSI-A, -B, -C, -D, -J, -AF, -BF, -CF, -DF, -JF OSIE-J, -JF GIC-400-J, -JF, -Q 740A, B	REC46-8M0113736	3861341					REC27-33918	3852111		
7.4GLPMDA, GLPMDM, GLIMDA, GLIMDM, GLPHUS, GIPHUSCE, GSIXHUS, GLIHUB, GIIHUBCE, GLPNCS, GLPNCB, GIINCCCE, GIPNCBCE, GIPNCSCE, GLINCC, GLINCS, GSIINCC, GSIXNCB, GLPNCA, GLPNCM, GIINCSCE, GIPNCACE, GIPNCMCE GLINCS, GSIINCS, GSIXNCMGLPLKD, GLPLKE, GIPLKDCE, GIPLKECE	REC46-8M0113735	3855991					REC27-33918	3852111		
8.2GLPMDA, GLPMDM, GLIMDA, GLIMDM, GSIXNCB 5.0FI, FL 5.8FI, FL (Ford 302 Et 351)	REC3853796	3853796	REC27-56880	3852824	REC3850360	3850360	REC27-33918	3852111		

BOMBAS DE AGUA WATER PUMPS POMPE ACQUA POMPE DE BRASSAGE



REF	OEM	
REC23059414	23059414	D31, 41, 42, 43, 44, 300 KAD32P



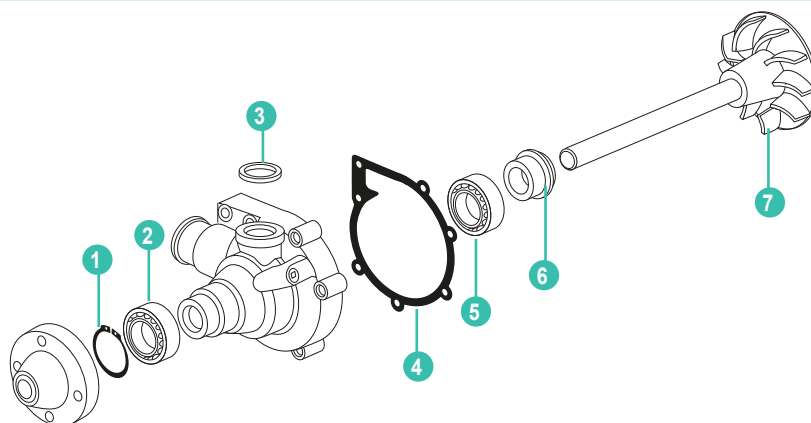

**DESPIECE BOMBA DE AGUA****WATER PUMPS PARTS****ESPLOSO POMPE DELL'ACQUA****PIÈCE DE POMPE D'EAU**

	REF	OEM				
	REC23059414	23059414	BOMBA COMPLETA	PUMP ASSY	POMPA COMPLETA	POMPE COMPLETE
1	REC914462	914462	CIRCLIP	CIRCLIP	CIRCLIP	CIRCLIP
2	REC181538	181538	COJINETE	BEARING	CUSCINETTO	ROULEMENT
3	REC3583913	3583913	RETÉN	SEALOIL	PARAOILIO	JOINT D'ETANCHEITE
4	REC859027	859027	JUNTA	GASKET	GUANIZIONE	JOINT
5	REC1660609	1660609	COJINETE	BEARING	CUSCINETTO	ROULEMENT
6	REC1676432	1676432	ESTOPADA	SEAL KIT	KIT PARAOLI	KIT JOINT
7	REC3583087	3583087	RODETE CON EJE	IMPELLER & SHAFT	GIRANTE POMPA ACQUA	TURBINE DE POMPE A EAU

**RODAMIENTO****BEARING****CUSCINETTO****ROULEMENT**

REF	OEM	
REC1660609	1660609 181670	D31, 40, 41, 30, 21, 70, 32, 300 D13, 42, 43, 44, 100, 120, 102, 103 D121, 122, 162, 163, 165, 60, 61, 62, 63, 71, 72, 73, 74, 75

**new****ANILLO DE DESGASTE ESTOPADA****SEALING RING****GUARNIZIONE****JOINT**

REF	OEM	
REC421306	421306	D31, D41, D30, D40, D21, D70, D42, D100, D120, D102, D121, D122, D162, D60, D61, D62, D63, D71, D72, D73 AQ: 115, 130, 165, 170 B: 20, 115, 165, 170

**new****ESTOPADA****SEAL KIT****KIT PARAOLIO****KIT JOINTS**

REF	OEM	
REC1676432	1676432 1545283 421174 1665527 15442883 1674032	D31, 40, 41, 30, 21, 70, 32, 300 D13, 42, 43, 44, 100, 120, 102, 103 D121, 122, 162, 163, 165, 60, 61, 62, 63, 71, 72, 73, 74, 75

**new****KIT REPARACIÓN BOMBAS DE AGUA****WATER PUMPS REPAIR KIT****KIT RIPARAZIONE POMPE ACQUA****KIT POMPE A EAU**

REF	OEM	
REC3801404	3801404 3801636 30751022 31293668	D3







### JUNTAS BOMBAS DE AGUA

### WATER PUMPS GASKETS

### GUARNIZIONE POMPE DELL'ACQUA

### KITS REPARATION ET KITS JOINTS DE POMPE D'EAU

REF	OEM	
REC876793	876793 876560	D30, 31, 32 TD30A AQAD30A AQAD31A MD30A TAMD30A TMD30A TMD31A, L-A TD31ACE AD31, L-A, P-A TAMD31L-A, M-A, P-A, S-A, A KAD32P



REF	OEM	
REC876794	876794 876544	D40, 41, 41A, 41L-A, 42, 43, 44, 300 TD40A MD40A TMD40A, B, C AQD40A TAMD40A, B AQAD40A, B TMD41A, L-A TAMD41A AD41A, L-A TAMD41H-A, H-B, L-A, M-A, P-A TAMD42WJ-A, B KAD42A, P-A KAMD42A, P-A KAD43P-A KAMD43P-A KAD44P-A, P-B, P-C KAMD44P-A, P-B, P-C KAD300 KAMD300

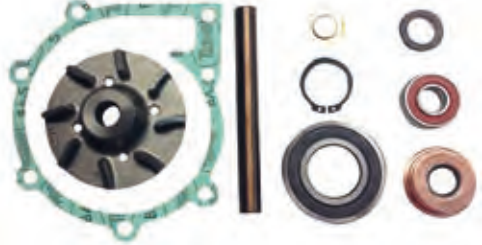

REF	
REC22125	MD21A AQD21A MD21B AQD21B (Versiones nuevas   Early version   Nuova versione   Nouvelle version)

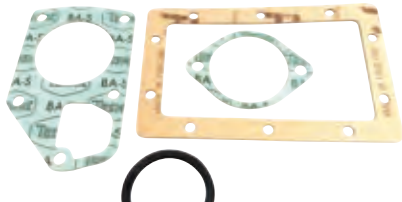

REF	
REC22126	MD21B AQD21B (Version moderna   Late version with pipe cooler   Versione moderna   version moderne)



### RODETE CON EJE

### IMPELLER AND SHAFT

### GIRANTE POMPA ACQUA

### TURBINE DE POMPE À EAU



REF	OEM		POMPA
REC3583087	3583087	D31, 41, 42, 43, 44, 300, 32	REC23059414



new

BOMBAS ASPIRACIÓN  
AGUA MARINA

RAW MARINE  
WATER PUMPS

POMPE ASPIRAZIONE  
ACQUA MARINA

POMPE A EAU DE MER



MOTORES GASOLINA

GAS ENGINE

MOTORI BENZINA









MOTEUR ESSENCE

BOMBAS DE AGUA







WATER PUMPS

POMPE ACQUA

POMPE A EAU

REF	OEM				
JOH10-32621-2	AQ120B				
	AQ125A, B				
	AQ131A, B, C, D				
	AQ140A				
	AQ145A, B				
	AQ151A, B, C				
	AQ171A, C				
	AQ251C				
	AQ230A, B				
	AQ250A, B				
	BB140A				
	BB145A				



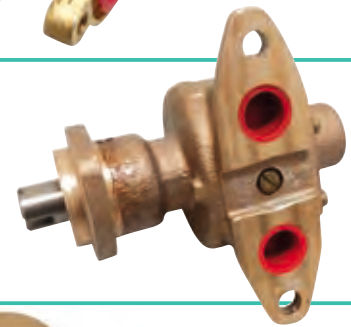

REF	OEM			
JOH10-32058-1	AQ165A			
	AQ170A, B, C			
	MD21A MO 103387-9			
	MD21B			
	AQD21B, A			
	BB165A			
	BB170A, B, C			





REF	OEM			
RM21212798	21212798 3812522	3.0GLP-D, P-E, P-J, P-N	REC21213664	REC3817687







REF	OEM			
RM21212801	21212801 21131568	3.0GXIC-J, GXI-J	REC21213664	REC3817687



REF	OEM			
RM21214595	21214595	3.0GLP-A, B, C	REC21213660	REC3857954
	3812696			
	3862485			
	3861417			





REF	OEM			
REC21214599	3.0GSMEFS, GSPEFS			REC21213660 REC3857954
	4.3GXI-C, GXI-CF, GXI-D, GXI-DF, GXI-SI,			
	GXI-E, GXI-EF, OSI-E, OSI-EF			
	5.0GXI-C, GXI-CF, GXI-D, SI-C, SI-CF, SI-D,			
	SI-DF, SI-E, GXI-EF, DSI-E			
	5.7GI, GXI, OSI, SXI, GXIL			





VOLVO

RECAMBIOS  
MARINOS

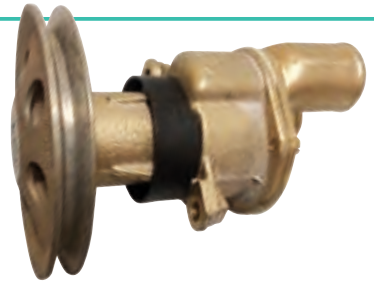
REF	OEM		
SHEG9903	3857794	3.0GL, GS	JOH09-1027B
	3851982	4.3GLP, GS, GI	
	3855079	5.0GL, GI, GS	
	3852399	5.7GL, GI	
		7.4GL, GI, GS	
	8.2GSI		



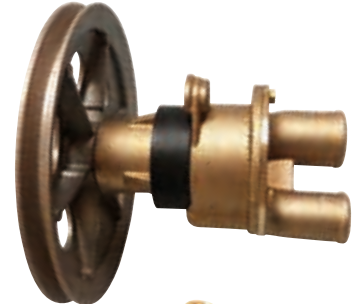

REF	OEM			
SHEG9901	3858847	4.3GLM, GLP, GS, GI	JOH09-1027B	165 mm
	3851623	5.0 Ford FI, FL, FS		
	3852398	5.7GI, GL		
	3855778	5.8 Ford FI, FL, FS		
		7.4GL, GI		
	8.2GL			



REF	OEM			
REC3860703	3860703 856513	V6 & V8	CEF500104	RM826422



REF	OEM			
RM21214596	21214596	4.3GL-A, GL- B, GL-C, GL-D, GLP	REC21213660	REC3857954
	3812697	5.0GL-A, GL-B, GL-C, GL-D, GL-E, GLP		
	3862487	5.7GL-A, GL-B, GL-C, GL-D, GL-E		
	3858229			





REF	OEM			
RM21255090	21255090 3812520	4.3GL-E, GL-EF 5.0GL-F, GL-FF	REC21213664	REC3812240



REF	OEM			
REC21212799	21212799	4.3GL-G, GL-GF, GXI-F, OSI-F, GXIE-M, GL-P, GXI-P, GXI-Q, GXI-GF, OSI-GF, GXI-G, OSI-G	REC21213664	REC3817688 REC3812240
	3812519	5.0GL-M, GL-HI, GXI-F, GXI-FF, OSI-FF, GXI-G, GXI-GF, OSI-G, OSI-GF, GIF-FF, GXI-G, GXI-GLI, OSI-E, OSI-EF, OSI-GF, SXI-G, SXI-GF, GI-F, GXIL-G, GIL-G, GXIL-H		



REF	OEM			
REC21214601	21214601 3812695 3862484 3860795	8.1	JOH09-1027B	REC3857954





REF	OEM		
REC21212800	21212800 3812518	8.1 GIE-P, FXIE-P, CICE-P/Q, G, H 8.1 IPS 8.1 OSI-C/CF, D, DF 8.1 GI-G, H	CEF500178G



REF	OEM			
JOH10-35098-3	829895	AQ60, 90, 95, 100, 105, 110, 115, 120A, 130 MB18, 20 MD3B, 17C, D Sin rosca   Without thread   Senza filetto   Non fileté	REC3586496	REC975672



### IMPULSORES

### IMPELLER

### GIRANTE

### TURBINES

REF	OEM	
REC3586494 JOH09-806B CEF500100GX	3586494 875807 876689	MB10A



REF	OEM	BOMBA PUMP POMPA POMPE
REC13554-0001 JOH09-812B CEF500124	13554-0001	REC3860703



REF	OEM	
REC3593659 JOH09-1026B CEF500116GX	3593659	AQ95, 100, 110 AQ115, A, B AQ120 AQ130A, B, C, D BB115A, B, C



REF	OEM	BOMBA PUMP POMPA POMPE	
REC3854286 SHE09959K CEF500103T	3854286	POLEA PULLEY PULIGGIA POULIE	3.0GL, GS 4.3GL, GS, GLM MDA, GLP MDA, GSP MDA 5.0FL, Fi 5.7GL, Gi, GIP MDA, GIP MDACE, GLP MDA 5.8FL, Fi, FSi 7.4GL (MD) 8.2GLP MDA, GLP MDM AQ200B, C AQ225B, C AQ255A



REF	OEM		
REC875575 JOH09-801B CEF500170CG	875575	AQD21A, B MD21A, B 230A, B 250A, B 251A AQ115A, B AQ120B AQ125A, B AQ130A, B, C, D AQ131A, B, C, D AQ140A AQ145A, B	AQ151A, B, C AQ165A AQ170A, B, C AQ171A, C AQD21A BB115A, B, C BB140A BB145A BB165A BB170A, B, C MB20A, B, C, D



REF	OEM	
REC10615K SHE10615K CEF500120T	835874	AQ190A AQ240A 64 mm H=41mm



REF	OEM		
REC21213664 CEF500178G	21213664	3.0GLP-J 4.3GL-J, GL-JF, GXi-B, GXi-BF, GXi-C, GXi-CF, GXi-D, GXi-DF, GXi-E, GXi-EF, GXi-J, GXi-JF, OSi-B, OSi-BF, OSi-C, OSi-CF, OSi-D, OSi-DF, OSi-E, OSi-EF 5.0GXi-J, GXi-JF 5.7 Gi-300-J, Gi-300-JF, GXi-J, GXi-JF 8.1Gi-J, Gi-JF, GXi-J, GXi-JF 8.2GSIPWTR	AQ60F, 90, 95, 95A, 100, 110, 120 AQ115A, B AQ130A, B, C, D BB100 BB115A, B, C BB30 DPX415XWTR MB18, F MB20A, B, C Nuevos modelos   New models   Modelli nuovi   Modèles nouveaux





REF	OEM		
REC22120-0001 CEF500104	876120	431A (Producción anterior   Earlier production   Produzione precedente   Production antérieure)	AQ200D (w = 50 mm) AQ205A, D AQ225E, F AQ255B AQ260A, B AQ271A, B, C, D AQ280A AQ290A AQ311A, B BB225A, B, C BB231A BB260A, B, C



REF	OEM		
REC21213660 JOH09-1027B CEF500107T	21213660	430A, B 431A, B 432A 434A 500A, B 501A, B 570A 571A 572A AQ175A AQ200D, F AQ205A AQ211A	AQ231A, B AQ255B AQ260A, B AQ271A, B, C, D AQ280A AQ290A AQ311A, B BB225A, B, C BB231A BB260A, B, C BB261A 3.0GL, GS (HU, NC, LK, BY, WT, EF) 4.3GIPBYCCE, GIPLKDCE, GIPNCBCE, GIPNCMCE, GLPBYC, GLPHUB, GLPLKD, GLPNCA, GLPNCB, GLPNCS, GSPBYC, GSPLKD, GSPNCB, GSPNCM, GL, GS (MD, HU, NC, LK, BY), Gi 5.0GL, Gi (BY), FL, Fi (HU, NC), FLPNCA, FLPNCS, GIPBYCCE, GLPBYC 5.7GL, Gi, GS, GSi, GIPLKECE, GIPLKDCE, GLPLKA, GLPLKD, GLPLKE, GSICPLKD, GSIPLKE, GSPBYC, GSPLKD, GSPLKE 5.8FL, Fi, FSi (HU, NC), FLPNCA 7.4Gi, GSi, GL (HU, NC, LK), GIPBYCCE, GIPHUSCE, GIPLKDCE, GIPLKECE, GIPNCA, GIPNCBCE, GIPNCMCE, GIPNCSCE, GLPHUS, GLPLKD, GLPNCA, GLPNCS, GSIPLKE, GSIPLKD, GSIXHUS 8.2Gsi (HU, NC, LK, BY), GL (HU), GSIPLKE, GSIPLKD, GSIXNCB



**GUÍA DE IMPULSORES (MÁS COMUNES)**      **IMPELLER APPLICATION (MORE COMMON)**      **GUIDA GIRANTE (PIU COMUNE)**      **GUIDE DES TURBINES (LES PLUS COMMUNES)**

		REF	CEF	JABSCO	JOHNSON	SHERWOOD
3.0GLP-C		REC21213660	CEF500107T		JOH09-1027B	
3.0GLP-D, E, J3.0GX1-J3.0GXIC-J		REC21213664	CEF500178G			
4.3GL-J/JF, GXI-J/JF, G/GF, OSI-J/JF, G/GF		REC21213664	CEF500178G			
5.0GL-J/JF, GXI-J/JF, G/G-F, OSI-J/JF, G/G-F		REC21213664	CEF500178G			
5.7GI300-J/JF/F/F, OSI-J/JF, GXI-J/JF/G/GF, OSXI-J/JF/E/EF		REC21213664	CEF500178G			
7.4GL (MD)		REC3854286	CEF500103T			SHE09959K
7.4GL (HU,NC,LK), GI, GSi, DPX385		REC21213660	CEF500107T		JOH09-1027B	
8.1GI-J/JF,H/HF, GXI-J/JF,G/GF, OSI-J/JF, D/DF		REC21213664	CEF500178G			
8.2GL		REC3854286	CEF500103T			SHE09959K
8.2GSI, DPX415 (HU-BY-WT)		REC21213660	CEF500107T		JOH09-1027B	
500A, B501A, B		REC21213660	CEF500107T		JOH09-1027B	
570A, 571A, 572A, AQ225B	31	REC21213660	CEF500107T		JOH09-1027B	
570A, 571A, 572A, 740A,B	50	REC18777-0001	CEF500104	JAB18777-0001-P		
AQ95, 100, 110 AQ115, A, B BB115A, B, C AQ120 AQ130A, B, C, D AQ120B AQ125A,B AQ131A, B, C, D AQ140, A BB140A • BB145A AQ145A,B AQ151A, B, C AQ165 AQ170A, B, C AQ171 230A, B.250B AQ225A, B,C		REC3593659	CEF500116GX		JOH09-1026B	
AQ225B, D, E, F BB225A, B, C BB231A AQ260A, B BB260A, B, C • BB261A AQ271A, B, C, D AQ280A • AQ290A		REC3854286	CEF500103T			SHE09959K
AQ311A, B	50	REC18777-0001	CEF500104	JAB18777-0001-P		
AQ231A, B AQ260A BB225A, B, C BB260A, B, C BB261A AQ271A, B, C, D AQ280A • AQ290A		REC21213660	CEF500107T		JOH09-1027B	
AQ311A, B	31					



MOTORES DIESEL	DIESEL ENGINE	MOTORI DIESEL	MOTEUR DIESEL
----------------	---------------	---------------	---------------



BOMBAS DE AGUA	WATER PUMPS	POMPE ACQUA	POMPE A EAU
----------------	-------------	-------------	-------------

REF	OEM			
JOH10-35098-3	829895	AQ60, 90, 95, 100, 105, 110, 115, 120A, 130 MB18, 20 MD3B, 17C, D Sin rosca   Without thread   Senza filetto   Non fileté	REC3586496	REC975672





REF	OEM			TUBO   TUBE			KIT	KIT EJE SHAFT KIT KIT ASSE KIT ARBRE
JOH10-24707-01	840557 861009	2001, B, AG, BG 2002, B, D, AG, BG 2003, B, D, AG, BG	REC3586496	REC829714	REC925093	REC21951368	REC21951414	



REF	OEM			KIT	KIT EJE SHAFT KIT KIT ASSE KIT ARBRE
JOH10-35157-1	858065 840076 833415 833883 807368	MD11D, C MD6A, B MD7A, B MD1B, 2B AQD2B MD5A, B, C MB10A Sin rosca   Without thread Senza filetto   Non fileté	REC3586496	REC21951368	REC21951422



REF	OEM			KIT	KIT EJE SHAFT KIT KIT ASSE KIT ARBRE
JOH10-35157-3	807368 833415 833522 833883	MD11D, C MD6A, B MD7A, B MD1B, 2B AQD2B MD5A, B, C MB10A Sin rosca   Without thread Senza filetto   Non fileté	REC3586496	REC21951368	REC21951422



REF	OEM			TUBO   TUBE		
JOH10-24268-4	858150	2003T, TB	JOH09-1027B	REC418411	REC925093	

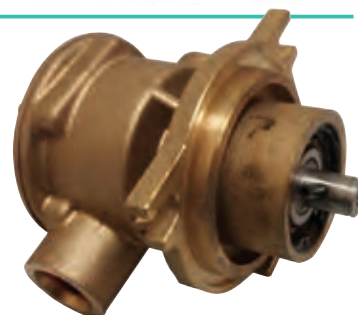







REF	OEM			
JOH10-24130-3	838522 844971	TAMD40A, B AQAD40A, B (Modelos antiguos   old style   modello vecchio   modèles anciens)	JOH09-1028B	REC968971





REF	OEM					
JOH10-24061-3	842843	TMD30A TAMD30A AQAD30A AQD40A MD40A TMD40A, B, C, (Modelos antiguos   old style   modello vecchio   modèles anciens)	REC3841697	REC829433	REC968971	

REF	OEM					
JOH10-24277-3	858469	TMD31A, B TMD41A, B TAMD31A, B AQAD41A, B AQAD31A D41A, B AD31A, B (Modelos antiguos   old style   modello vecchio   modèles anciens)	REC3841697	REC858467	REC968971	



REF	OEM					
REC3583115	3583115 860629 3581558 860827	31, 32, 40, 41, 42, 43, 44, 300 Para manguitos fijados con abrazaderas. For hose connectors with clamps. Modello pompa de montare con manicotti bloccati con fascette Pour les manchons clampés.	REC3841697	REC858467	REC968971	

REF	OEM						
REC3829311	3829311 846354	TAMD61A, B SN (-1101014435 / XXXXX:A) TMD100C, 102A, 122A, 121C, 120B TAMD102A, 102C, 121C, 121D					



REF	OEM						
REC3829313	3829313 3829312 866396 845189	TAMD102A, 102D, 103A, 120B, 122A, 122C, 122D, 122P-A, 122P-B, 122P-C					

REF	OEM						
REC3837935	3837935 3825493 876809 863437	TAMD162A, B, C, C-B, C-C TAMD163A-A, P-A TAMD165A-A, C-A, P-A					





REF	OEM		
REC3593655	3593655		
	3580945	D1-30, B, F	
	3580222	D2-40, B, F	
	3580223	MD2030A, B, C, D	REC3593659
	3580910	MD2040A, B, C, D	
	3580920		





REF	OEM			
REC3593654	3593654	D1-13, B, F		
	3580064	D1-20, B, F		
	3580944	MD2010A, B, C, D	REC3593659	REC23035
	3580900	MD2020A, B, C, D		



REF	OEM			
REC3583089	3583089	D2-50F		
		D2-55B, C, D, E, F	JOH09-1027B	REC23038
		D2-60F		
		D2-75B, C, F		





REF	OEM		
REC21141637	21141637 3593656 3884694	D3-110I-A, I-B, I-C	
		D3-130A-A, I-A, I-B, A-B, A-C	
		D3-160A-A-, I-A, I-B, I-C, A-B, A-C	JOH09-812B
		A-C	
		D3-190I-B, I-C, A-B, A-C	



REF	OEM		
REC21379102	21379102 21106041	D3-110 --> D3-220	JOH09-812B





REF	OEM			KIT 
REC3584062	3584062	D4-180I-B, I-C, I-D, I-E, I-F D4-210A-A, I-A, I-B D4-225A-C, A-D, I-B, I-C, I-D, I-E, I-F D4-260A-A, A-B, A-C, A-D, D-B, D-C, D-D, I-A, I-B, I-C, I-D D4-300A-A, A-C, A-D, D-A, D-C, D-D, I-A, I-C, I-D	JAB17937-0001-P	REC062MINORKIT



REF	OEM			KIT 
REC21419374	21419374	D4-225A-E, A-F D4-260A-E, A-F, D-E, D-F D4-300A-E, A-F, D-E, D-F	REC3841697	REC374MINORKIT



REF	OEM			KIT 
REC3838288	3838288	D5A-T, A-TA, A-BTA D7A-T, A-TA, A-BTA D7C-TA, C-BTA	REC3841697	REC288MINORKIT



REF	OEM			KIT 
REC21419376	21419376	D6	REC3887761	REC376MINORKIT



REF	OEM			KIT 
REC21380890	21380890 3589907 3584063	D6	REC3593573	REC890MINORKIT





**BOMBAS DE AGUA  
SISTEMAS IPS**



**WATER PUMPS  
IPS SYSTEM**

**POMPE ACQUA  
SISTEMA IPS**



**POMPE A EAU  
SYSTEME IPS**

REF	OEM			KIT 
REC21380886	21380886 3819485 3836314	D9A D11A	JAB17018-0001	REC886MINORKIT





REF	OEM			KIT 
REC22063494	22063494	D11B1-AMP D11B2-AMP (IPS)	JAB17018-0001	REC494MINORKIT



REF	OEM			KIT 
REC21219723	21219723	D11A-D (IPS) D11A-C MP D11B2-A MP	REC21730344	REC723MINORKIT





REF	OEM			KIT 
REC3838207	3838207 865295	D12D-A, D-B, D-C, C-A, D-F, D-E, D-G	JAB17938-0001-P	REC207MINORKIT



REF	OEM			KIT 
REC22905150	22905150 3886848	D13B, C	JAB17938-0001-P	REC207MINORKIT



REF	OEM			KIT 
REC22905155	22905155 3589104	D16C-DMH, AMH, BMH, CMH, AMG	JAB17938-0001-P	REC207MINORKIT



**IMPULSORES****IMPELLER****GIRANTE****TURBINES**

REF	OEM	
REC21730344 CEF500105T JOH09-1029B	2170344	TAMD40 AD40 D11B2 TAMD71B TAMD61A TAMD62A D11A, B, C (IPS)



REF	OEM	
REC21213664 CEF500178G	21213664	D3-110I-A, I-B, I-C D3-130A-A, A-B, A-C, I-A, I-B, I-C D3-160A-A, A-B, A-C, I-A, I-B, I-C D3-190A-B, A-C, I-B, I-C



REF	OEM	
REC875575 JOH09-801B CEF500170CG	875575	AQD21A, B MD21A, B



REF	OEM	
JAB17938-0001-P CEF500163G	3830459	D12C-A, D-A, D-B, D-C, D-D, D-F MP D13B-E, B-N MH D13C1-A, C2-A, C3-A, C4-A MP D12D-A, B, C, E, G MH • D12 D16C-A, B, C MH, MG

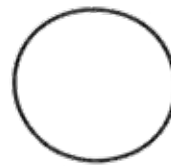

REF	OEM	
CEF500380	3555413	MB2, 505



REF	OEM	
REC3593659 CEF500116GX JOH09-1026B	3593656 22222936	D1-13 A, B, F D1-20 A, B, F D1-30 A, B, F D2-40 A, B, F MD17D MD2030A, B, C, D MD2040A, B, C, D MD3B MD2020 (101309052+) MD2010 (5101203008+)



REF	OEM	
REC21213660 CEF500207 JOH09-1027B	21213660	D2-55 A, B, C, D, E D2-75 A, B, C, F MD22A, L-A TMD22A Impulsor con casquillo estriado Grooved socket impeller Girante con mozzo scanalato Turbine avec douille cannelée



REF	OEM	
REC17937-0001 JAB17937-0001-P CEF500114T	3588475	D4-180i-B, I-C D4-210A-A, A-B, i-A, i-B D4-225A-B, A-C, i-B, I-C D4-260A-A, A-B, A-C, D-B, D-C, i-A, i-B, I-C D4-300A-A, A-C, D-A, D-C, I-A, I-C AQ21A MD21A AQD21B MD21B (xxxx103387+)

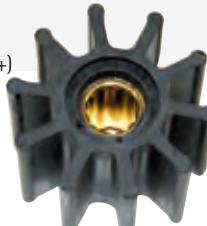

REF	OEM	
REC3586496 CEF500121GX JOH09-808B	21951342	2001, B 2002, B 2003, B MD11D MD5A, B, C MD6B MD7A, B





REF	OEM	
REC3593573 JAB17018-0001 CEF500177GT	3593573 21730348	D6-280A-A, A-B, i-A, i-B D6-310A-A, A-B, D-A, D-B, i-A, i-B D6-330A-B, A-C, D-B, D-C, I-B, I-C D6-350A-A, A-B D6-370A-B, A-C, D-A, D-B, D-C, i-A, i-B, I-C D6-435D-A, D-C, i-A, I-C D11A-A D9A2A, B, D, F







REF	OEM	
REC3586494 CEF500100GX JOH09-806B	3586494	2003T, TB 2010 (-5101203008) 2020 (-5101309052) AQD2B MD1, 1B, 2, 2B, 6 MD1 (14016+) MD2 (4211+) MD2010A, B, C, D MD2020A, B, C, D MD22A, L-A, L-B, P-B TAMD22P-B TMD22A, B AQD21A, B MD21A MD21B (-103386)









REF	OEM		
REC3887761 JOH09-821B CEF500162G	21951358 3887761	TAMD63L-A, P-A D6-280A-E D6-310A-E, D-E D6-300A-F, D-F, A-E, D-E D6330A-F, D-F D6-370A-F, D-F, I-F, A-E, D-E D6-400A-F, DF, A-E D6-435D-F, I-SC-F, I-WJ-F	

REF	OEM		
REC875697 JOH09-814B CEF500145T	875697 21951364 875814	TAMD162A, B, C TAMD163A, P-A TAMD102A TAMD103A-A TAMD120B TAMD121C, D TAMD122A, C, D, P-A, P-B	

REF	OEM			
REC21730344 JOH09-819B CEF500135	21951362 8777066	AQAD40A, B MD100A, B MD120A TAMD120A TAMD40B TAMD61A TAMD62A TAMD71A, B TAMD72A, P-A TMD100A, C TMD102A TMD120A, B TMD121C TMD122A TAMD73P-A, WJ-A TAMD74A-A, A-B, C-A, L-A, L-B7, P-A, P-B TAMD75P-A	Ø 95 mm	5

REF	OEM			
REC3841697 JOH09-1028B CEF500106GT	3841697 21951356	AD31A, B, D, L-A, P-A, X AD41A, B, D, L-A, P-A AQAD30A, 31A, 41A AQD32A, 40A, 41A AQD70B, C, D D4 D41A, B, D KAD300-A KAD32P KAD42A, B, P-A KAD43P, P-A KAD44P, P-B, P-C 00-A KAMD42A, B, P-A KAMD43P KAMD44P-A, P-B, P-C MD30A, 31A, 32A, 70B, 70C TAMD30A TAMD31A, B, D, L-A, M-A, P-A, S TAMD41A, B, D, H-A, M-A, P-A TAMD42WJ-A TAMD60A, B TAMD70B, C, D, E TMD30A TMD31A, B, D, L-A TMD40A, B, C TMD41A, B, D, L-A THAMD70B-C	Ø 65 mm	6



GUÍA DE IMPULSORES (MAS COMUNES)	IMPELLER APPLICATION (MORE COMMON)	GUIDA GIRANTE (PIU COMUNE)	GUIDE DES TURBINES (LES PLUS COMMUNES)
		REF	CEF JABSCO JOHNSON
MD1A, BMD2A, BMD5A, B, CMD6A, B MD7A, BMD11C, D (Lid 4 screws)		REC3586496	CEF500121GX JOH09-808B
MD1A, BMD2A, BMD5A, B, CMD6A, B MD11C, D (Lid 6 screws)		REC3586494	CEF500100GX JOH09-806B
MD3BMD17C, D20012002 2003		REC3586496	CEF500121GX JOH09-808B
MD21A, BAQAD21A, B		REC875575	CEF500170CG JOH09-801B
MD22A, BTMD22A, BTAMD22A2003T D2-50, -55, -60, -75			CEF500107T JOH09-1027B
MD2010 SN -5101309052 MD2020 SN -5101309052		REC3586494	CEF500100GX JOH09-806B
MD2010 SN +5101203009 MD2020 SN +5101309053 MD2030 MD2040		REC3593659	CEF500116GX JOH09-1026B
MD30A, B, D, AQTAMD30A, B, D, AQTMD30A, B, D, AQAQAD30A, 31A AD31, A, B, D, XC, P, -AMD31, ATMD31A, B, D, L-ATAMD31A, B, D, P, L, M, S-A KAD32AMD40ATMD40A, B, CTAMD40B AQD40AAQAD40A, BTMD41A, B, D, L-ATAMD41A, B, D D41A, B, D, L-AAD41A, B, DAQD41AAQAD41A TAMD41P, L, M, H-A, H-BAD41P, L-AKAD42A, B, P-AKAMD42A, B, P-A TAMD40 AD40		REC3841697	CEF500106GT JOH09-1028B
KAD43P-AKAMD43P-AKAD44P-A, P-B, P-CKAMD44P-A, P-B, P-C KAD300AKAMD300A		REC21730344	CEF500105T JOH09-1029B
D1-13, -20, -30, -40		REC3841697	CEF500106GT JOH09-1028B
D3		REC3593659	CEF500116GX JOH09-1026B
D4 E-F AQ & IPS		REC21213664	CEF500178G
D4 A-D AQ & IPS, ALL INBOARD MODELS		REC3841697	CEF500106GT JOH09-1028B
D6 E-F AQ & IPS		REC17937-0001	CEF500114T JAB17937-0001-P
D6 A-D AQ & AQ & IPS, ALL INBOARD MODELS		REC3887761	CEF500162G JOH09-821B
		REC3593573	CEF500177GT JAB17018-0001

COMPONENTES BOMBA DE AGUA

WATER PUMP COMPONENTS

COMPONENTI DELLA POMPA DELL'ACQUA

ACCESSOIRES DE POMPE A EAU

VÁLVULA DE VACÍO

VACUUM VALVE

VALVOLA DI VUOTO

VANNE À VACUUM

REF	OEM		Ø
REC21662702	21662702	D1, D2 MD201, MD2020, MD2030, MD2040	19 mm

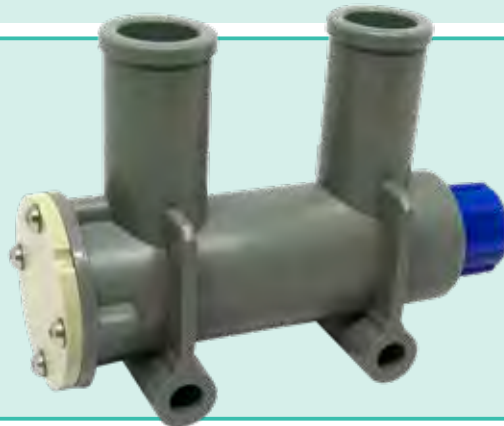

new

TOPE BOMBAS

PUMP STOP

ALETTA ARRESTO POMPE

BUTEE DE POMPE A EAU DE MER

REF	OEM	BOMBA PUMP POMPA POMPE
REC3857954	3857954	REC21214599 REC21214601 RM21214596 RM21214595



CONSOLA PARA BOMBAS

PUMP CONSOLE

TIRANTE PER POMPE

SUPPORT DE POMPE A EAU

REF	OEM
REC3812240	3812240



REF	OEM
REC3817687	3817687



CONSOLA PARA BOMBAS E INTERCAMBIADORES DE CALOR

CONSOLE FOR PUMPS AND HEAT EXCHANGERS

TIRANTE PER POMPA E SCAMBIATORE DI CALORE

SUPPORT DE POMPE A EAU ET D'ECHANGEURS

REF	OEM
REC3817688	3817688

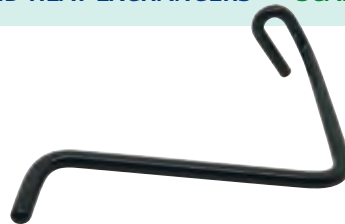

PIN CENTRADOR

LOOKING PING

PIN CENTRATORE

PIN DE CENTRAGE

REF	OEM
REC826239	826239



new



PASADOR EJE BOMBA DE AGUA

PIN

SPINOTTO

CLAVETTE

REF	OEM	
REC973639	973639	2001, 2002, 2003



new

**COJINETE BOMBA WATER PUMP BEARING CUSCINETTO POMPA ROULEMENT DE POMPE**

Cojinete (2 Piezas) para bomba en cigüeñal tapa de 4 tornillos

Bearing (2 pcs) 4 bolt crankshaft cover

Cuscinetto (2pz) per pompa albero motore, 4 vite nel coperchio

Roulement (2 pièces) pour la pompe, couvercle avec 4 vis.

REF	OEM	
REC183861	175A	311A, B
	200C, D, F	430A, B
	211A	431A, B
	225C, D, F	500A, B
	231A, B	570A, 571A, 572A
	255A, B	BB225A, AV, B, C
	260A	231B
	271A, C	255AV
	290A	260A, AV, B



REF	OEM	
RECV11010	861812	2003T, B, TB D31, 32, 40, 41, 42 43, 44, 300
	3578536	
	3884972	
	11010	
	6600756	



REF	OEM	BOMBA PUMP POMPA POMPE
REC181717	181717	JOH10-35098-3 JPH10-24707-01 REC3593654



new

**TAPA DEPÓSITO EXPANSIÓN EXPANSION DEPOSIT COVER COPERCHIO DEPOSITO ESPANSIONE BOUCHON DE VASE D'EXPANSION**

REF	OEM
REC1674083	1674083
	1357775
	463828
	1674084
	3850064



**TORNILLOS TAPA DE LA BOMBA SCREW PUMP COVER VITI COPERCHIO POMPA VIS DU COUVERCLE DE POMPE**

REF	OEM		
REC855728	855728	V6 & V8	6
REC840785	804693	AQ200D, 225D, 225B, 260A, 280A, 290	6
	803723	MD1A, B, MD2D, B, MD3B, MD17C, A	
	840785		
REC841693	841693	AQ175A, 200D, 211A, 225D, F	4
REC840384	833997	V6 & V8	4
	840384	MD11C	



REC855728  
REC840785



REC841693  
REC840384

REF	OEM
REC21951302	21951302



new

**PESTAÑA DE SUJECCIÓN PARA BOMBAS CON COJINETE DE BOLA MOUNTING CLAMP FOR BALL BEARING PUMPS PIASTRA DI SUPPORTO PER POMPA CON CUSCINETTO A SFERE BRIDE DE POMPE A EAU AVEC ROULEMENT**

REF	OEM	
REC833878	833878	AQ60, 90, 95, 100, 105, 110, 115, 120A, 130
		MD6A, B
		MD7A, B
		MD1B, 2B, 3B
		AQD2B
		MD11C, D
		MD17C, D
		MD20A, B, C



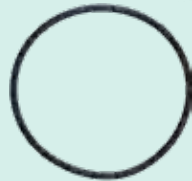
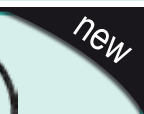

**ANILLO TÓRICO TRASERO BOMBA AGUA**    **BACK O-RING**    **FASCIA TONDA**    **JOINT TORIQUE**

REF	OEM	
REC3580380	3580380 3580917	D1/D2 MD2010 MD2020 MD2030 MD2040



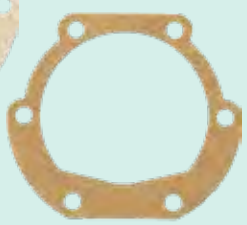

**JUNTA TAPA IMPULSOR**    **IMPELLER GASKET COVER**    **GUARNIZIONE COPPERCHIO GIRANTE**    **JOINT DE COUVERCLE DE TURBINE**

REF	OEM		BOMBA PUMP POMPA POMPE
REC833994	833994	MD11, MD17 MD1, MD2, MD5 2001, 2002, 2003 AQD2B, MD6, MD7, MB10A AQ115, AQ130, AQ165, AQ170 B20, BB115, BB170	JOH10-24707-01 JOH10-35157-1 JOH10-35157-3
REC840385	840385	MB20, AQD21, AQD2B D1, D2, MD11, MD17, MD1, 2010, 2020, 2030, 2040 D1/D2	JOH10-35098-3 REC3593654
REC819959	819959	MD1, MD11, MD17 MD2010, 2020, 2030, 2040 AQ115, 130, 165, 170	





REC833994    REC840385    REC819959

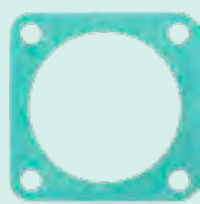
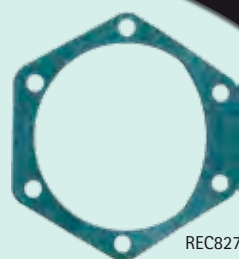

**JUNTA TAPA BOMBA**    **PUMP COVER GASKET**    **GUARNIZIONE POMPA**    **JOINT DE POMPE**

REF	OEM		BOMBA PUMP POMPA POMPE
REC124240-01883	862583	D11, D12, D13, D16 MD120, 122, 102, 103, 120, 162, 163, 165 AQ & BB 115, 130, 165, 170, 20	
REC827250	827250	D21	JOH10-32058-1

REC124240-01883    REC827250



**CENTRADORES BOMBA ASPIRACION**    **WATER PUMPS CROSS PIECES**    **CENTRATORI POMPA ASPIRAZIONE**    **TOC D'ENTRAINEMENT DE POMPE A EAU**

REF	OEM		
REC831009	831009 806256	AQ120, 120B, 125, 130, 131, 140A, 145, 151, 165, 170, 171, 230A, 250A, 251A MD3B MD17C, D MD21A, B	
REC858467	858467	MD31, 41 KAD32, 42, 43, 44, 300 KAMD42	
REC829433	829433	TMD, TAMD, AQAD, MD30A TMD, AQD, MD40A	6







**CIRCLIP**    **CIRCLIP**    **CIRCLIP**    **CIRCLIP**

REF	OEM
REC914515	914515









KIT RETENES Y JUNTAS BOMBA ASPIRACIÓN	GASKET KITS FOR RAW WATER PUMPS	KIT PARA OLIO E GUARNIZIONI	KIT JOINTS DE POMPE
REF			
REC22042	AQ60, 90, 95, 100, 105A, 110, 115, 120A AQ130A, B, C, D MB18 • MB20A, B, C • MD3B, 17C, D BB30, 100 • BB115, B, C Para bombas sin cojinete de bola For pumps without ball bearing Per pompe senza cuscinetto Pour pompe, sans roulement	REC3593659	
REF			
REC22009	AQ60F, 90, 95, 100, 105A, 110, 115, 120, 130 MB18, 20 • MD3B, 17C, D BB30, 100 • BB115B, C D1-13A, B, F • D1-20A, B, F • D2-40A, B Para bombas sin cojinete de bola For pumps without ball bearing Per pompe senza cuscinetto Pour pompe, sans roulement	REC3593659	
REF			
REC22047	AQ165A AQ170A, B, C BB165A BB170A, B, C AQD21A, B MD21A MO (103387+) MD21B	REC875575	
REF			
REC22072	AQ120B, 125, 131, 140, 145, 151, 171, 230A, 250A, 251A	REC875575	
REF			
REC22053	MB10A D1A, D2A MD1A, B • MD2, 2A, 2B, 6A AQD2A, B Versiones nuevas con cojinete plano Early version with plain bearing Nuova versione con cuscinetto piano Nouvelle version avec roulement plat	REC3586494	
REF			
REC22054	MD5A, B, C MD6B MD7A, B MD11C, D 2001, 2002, 2003AG, B, BG	REC3586494	
REF			
REC22040	2003T, TB	REC21213660	
REF			
REC22167	MD2010C, D MD2020C, D MD2030C, D MD2040C, D		

REF				
REC22016	D30, 31, 32, 40, 41, 42, 43, 44		REC3841697 Ø 65 mm	6



REF				
REC22089	AQAD40A, B TAMD40A, B		REC21730344 Ø 95 mm	5



KITS REPARACIÓN BOMBA ASPIRACIÓN

IMPELLER WATER PUMPS SERVICES KIT

KIT RIPARAZIONE POMPA ASPIRAZIONE

KITS RÉPARATION DE POMPE A EAU

KITS DE EJE

SHAFT KIT

KIT ASSE

KIT ARBRE

REF	OEM		
REC21951422	21951422	MD5, MD6, MD7, MD11	



REF	OEM		
REC21951414	21951414	2001, 2002, 2003	



KITS DE BOMBA

PUMP KIT

KIT POMPA

KIT POMPE

REF	OEM		
REC21951368	21951368	2001, 2002, 2003	





REF	OEM		
REC875698	875698 21951420	AQ60, 90, 95, 100, 105, 110, 115, 120, 130 MD3B, 17C, 17D • MB18 • M20A, B, C	REC875698



REF	OEM		
REC22073	AQ60, 90, 95, 100, 105, 110, 115, 120, 130 MD18, 20, 3B, 17C, 17D		REC3593659



REF	OEM	
REC23035	MD2010C, D • MD2020C, D MD2030A, B, C, D • MD2040A, B, C, D D1-13A, B, F • D1-20A, B, F • D1-30A, B, F • D2-40A, B, F	



REF			
REC23038	D2-55A, B, C, D, E, F D2-75A, B, C, F		



REF			
REC207MINORKIT	D12D-A MH, D-B MH, D-A MP, D-B MP, D-C MP, D-D MP, D-E MP, D-F MP, D-G MP, D-H MP, D-C MH, C-A MP D16C-A MH, C-B MH, C-C MH, C-A MG		



REF	OEM		
REC875584	MD5A, B, C MD6B MD7A, B MD11C		
	Viene sin leva y sin tapa Cam & cover not included Camma e coperchio non inclusa Livré sans came ni couvercle		REC3586496



REF	OEM		
REC877373	877373 876088 876529 875759	31, 32, 40, 41, 42, 43, 44, 300	REC3841697 Ø 65 mm





REF	OEM		
REC875383	AQ165A, 170A, 170B, 170C BB165A, 170A, 170B, 170C MD21A (103387+), 21B AQD21A (103387+), 21B		
	Viene sin leva Cam not included Camma non inclusa Livré sans came		REC875575



REF	OEM		
REC875756	2001, 2003 AG, B, BG 2002AG, B, BG, D MD1A, B MD2A, B MD5A, B, C MD6A, B MD7A, B MD11C, D AQD2B		
	Viene sin leva y sin tapa Cam & cover not included Camma e coperchio non inclusa Livré sans came ni couvercle		REC3586496



REF	OEM		
REC875574	AQ120B AQ125A, B AQ131A, B, C, D AQ140A AQ145A, B AQ151A, B, C		
	Viene sin leva Cam not included Camma non inclusa Livré sans came		REC875575



REF	OEM		
REC875769	875769 21951410	AD40B AQAD40A, B TAMD40A, B	REC21730344 Ø 95 mm



REF	BOMBA PUMP POMPA POMPE
REC062MINORKIT	REC3584062



Parts for REC062MINORKIT: A black gear, a brass housing, a brass ring, a black seal, a brass plate, and various small fasteners.

REF	BOMBA PUMP POMPA POMPE
REC288MINORKIT	REC3838288



Parts for REC288MINORKIT: A brass ring, a black gear, a black seal, a brass plate, a brass ring, and various small fasteners.

REF	BOMBA PUMP POMPA POMPE
REC890MINORKIT	REC21380890



Parts for REC890MINORKIT: A brass ring, a brass housing, a black gear, a black seal, a brass plate, and various small fasteners.

REF	BOMBA PUMP POMPA POMPE
REC886MINORKIT	REC21380886



Parts for REC886MINORKIT: A black seal, a black gear, a brass ring, a brass plate, and various small fasteners.

REF	BOMBA PUMP POMPA POMPE
REC376MINORKIT	REC21419376



Parts for REC376MINORKIT: A black seal, a black gear, a brass ring, a brass plate, and various small fasteners.

REF	BOMBA PUMP POMPA POMPE
REC494MINORKIT	REC22063494



Parts for REC494MINORKIT: A black seal, a black gear, a brass ring, a brass plate, and various small fasteners.

REF	BOMBA PUMP POMPA POMPE
REC374MINORKIT	REC21419374



Parts for REC374MINORKIT: A black seal, a black gear, a brass ring, a brass plate, and various small fasteners.

REF	BOMBA PUMP POMPA POMPE
REC723MINORKIT	REC21219723



Parts for REC723MINORKIT: A black seal, a black gear, a brass ring, a brass plate, and various small fasteners.









RETENES	SEALS	PARAOLIO	BAGUE
CUERPO TERMOSTATO	THERMOSTAT HOUSING	CORPO TERMOSTATO	CORPS DE THERMOSTAT

REF	OEM		
REC3583913	3583913 1542198	D31, D41, D300, D32, D42, D43, D44	<i>new</i>

RETÉN INFERIOR FILTRO AGUA ANTIGUO	LOWER SEAL OLD WATER FILTER	PARAOLIO INFERIORE FILTRO ACQUA VECCHIO	BAGUE INFÉRIEURE DE FILTRE A EAU (ANCIEN)
---------------------------------------	--------------------------------	--	--



REF	OEM		
REC845354	845354	D31, D41, D30, D13	<i>new</i>



EJE DE LA BOMBA	PUMP SHAFT	ASSE POMPA	JOINT TORIQUE D'ARBRE DE POMPE
-----------------	------------	------------	-----------------------------------



REF	OEM		
REC960166	960166	2003 D30, 31, 41, 70, 32, 300, 42, 43, 44, 40, 3, 4 740 AQ & BB 115, 130, 165, 170, 20	<i>new</i>

DISTRIBUIDOR		DISTRIBUTOR	DISTRIBUTORE	JOINT DE DISTRIBUTEUR
REF	OEM			
REC969331	969331 967763	250A, B 251A AQ131A, B, C, D AQ151A, B, C AQ171A, C		

new











RETÉN BOMBA DE AGUA		WATER PUMP SEALS	PARAOLIO POMPA ACQUA	JOINT SPI DE POMPE A EAU
REF	OEM			
REC804695	804695	AQ60, 90, 95, 100, 105, 110, 115, 120A, 130 MB10A, 18, 20	MD1B, 2B, 3B, 6A MD17C, D	

REF	OEM			
REC833996	833996	AQ60, 90, 95, 100, 105, 110, 115, 120A, 130 MB18, 20	MD3B MD5 A, B, C, D1, D2 MD6B MD7A, B MD11C, D, 2001, 2002, 2003 MD17C, D 2010, 2020, 2030, 2040 Para bombas con rodamiento en eje bomba For pumps with bearing in shaft Per pompa con cuscinetto nell'asse della pompa Pour pompe avec roulement dans l'arbre de la pompe	

REF	OEM			
REC827247	827247	AQ120B, 125, 131, 140, 145, 151, 165, 170, 171, 230A, 250A, 251A AQ430A, B AQ431A, B 500A, B 501A, B 570A, 571A, 572A Para bomba con tapa de 4 tornillos. Todas las bombas V6/V8 modernas instaladas en cigüeñal. 4 bolt cover. All modern V6 / V8 pumps installed on crankshaft. Per pompa con 4 viti nel coperchio. Tutte le moderne pompe V6 / V8 installate sull'albero motore. Pour pompe avec couvercle à 4 vis. Toutes les pompes V6/V8 modernes montage en bout de vilebrequin.	2003T MD21A (103387+), B MD30, 31, 40, 41 KAD42A KAMD42A, D3, 300 Para bomba con tapa de 6 tornillos 6 bolt cover Per pompa con 6 vite in coperchio Pour pompe avec couvercle à 6 vis	

REF	OEM			
REC430172	430172	AQ165A AQ170A, B, C BB165A BB170A, B, C		

new

RETENES TUBOS REFRIGERACION				ENGINE HOSES SEALS		GOMMINI TUBI DI REFRIGERAZIONE				JOINTS TUYAUX DE REFROIDISSEMENT	
REF	OEM	Ø ext				REF	OEM	Ø ext			
REC831622	831622	29 mm	AQ120B AQ125A, B AQ131A, B, C, D AQ140A AQ145A, B AQ151A, B, C AQ171A, C		REC829714	829714	17 mm	AQ90, 95, 100, 105, 110, 115, 120, 130 MB10A MD5A, B, C MD7A, B MD11D			
REC831617	831617	29 mm	AQ165A AQ170A, B, C, MD21 (103387+), B		REC418411	418411	20 mm	AQ90, 95, 100, 105, 110, 115, 120, 130 MB18, 20 MD11C, D MD17C, D 2001, 2002, 2003			
REC418412	418412	27 mm	AQ120B AQ125A, B AQ131A, B, C, D AQ140A AQ145A, B AQ151A, B, C, D AQ165A AQ170A, B, C AQ171A, C 230A, 250A, 251A MD21A, B		REC968555	968555		AQ131, AQ151, AQ171 230, 250, 251		new	
RM831960	831960	21 mm	2001, 2002, 2003		REC430272	430272		AQ, BB 165 et 170		new	
REC418445	418445	23 mm	AQ90, 95, 100, 105, 110, 115, 120, 130 MD11C, D MD17C, D 2001, 2002, 2003		REC430018	430018		AQ165A AQ170A, B, C BB165A BB170A, B, C		new	
REC430020	430020	34 mm	AQ120B AQ125A, B AQ131A, B, C, D AQ140A AQ145A, B AQ151A, B, C AQ171A, C 230A, 250A, 251A		REC955976	955976 12262 926033 14012262 6647311		AQ120, 125, 140, 145 BB140, 145		new	



KITS RETENES TUBOS REFRIGERACION				ENGINE HOSES SEALS KIT		KIT GOMMINI TUBI DI REFRIGERAZIONE				KITS JOINTS POUR TUYAUX DE REFROIDISSEMENT	
REF						REF					
REC22061	AQ115, 130 BB115				REC22051	AQ120B, 125, 140, 145 BB140A, 145A					
REC22037	AQ131, 151, 171, 230, 250, 251				REC22012	AQ165, 170 BB165, 170					

**KITS RETENES, TUBOS REFRIGERACIÓN****ENGINE HOSES SEALS KIT****KIT GOMMINI TUBI DI REFRIGERAZIONE****KITS JOINTS POUR TUYAUX DE REFOIDISSEMENT**

REF	OEM	
REC22011	876224	2001, 2002, 2003, AG, B, BG



REF	
REC22025	MD17C, D



REF	
REC22017	2002, 2003, AG, B, BG Con circuito agua dulce. Fresh water cooling system Circuito acqua dolce Circuit eau douce



REF	
REC22114	MD30A TMD30A



REF	
REC22008	2003T, TB Con circuito agua dulce. Fresh water cooling system Circuito acqua dolce Circuit eau douce



REF	
REC22115	AQAD30A TAMD30A AD30A



REF	
REC22019	MD5A, B, C



REF	
REC22116	MD40A TMD40A, B, C TAMD40A, B AQD40A AQAD40A AD40B

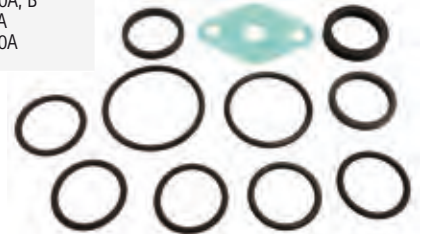

REF	
REC22024	MD6A, B MD7A, B





REF	
REC22021	MD11C, D





REF	
REC22113	D31, 32, 41, 42, 43, 44

**TUBO AGUA TERMOSTATO****THERMOSTAT WATER TUBE****TUBO ACQUA TERMOSTATO****TUYAU D'EAU THERMOSTAT**

REF	OEM		
REC968927	968927	D31, D41, D300, D32, D42, D43, D44	<b>new</b>



**INTERCAMBIADOR      EXCHANGER      SCAMBIATORE      ECHANGEUR**

REF	OEM		
REC430272	430272	D70	

*new*

REF	OEM		
REC925096	925096 12330	D40, D162, 163, 165	124.5 X 3 mm

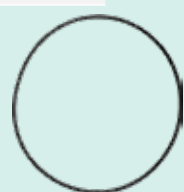

*new*

REF	OEM		
REC855582	855582	230, 250, 251 AQ 131, 151, 171	

*new*

**ADMISIÓN AIRE      AIR INTAKE      ASPIRAZIONE ARIA      ADMISSION D'AIR**

REF	OEM		
REC948610	948610	39.2 X 3 mm	

*new*

**ENFRIADOR      COOLER      RAFFREDDATORE      REFFROIDISSEUR**

REF	OEM		
REC925068	925068 23405 14023405 11991571	MD30	42.2 X 3 mm



*new*

**SISTEMA DE REFRIGERACIÓN      COOLING SYSTEM      SISTEMA RAFFREDDAMENTO      SYSTÈME DE REFFROIDISEMENT**

REF	OEM		
REC925096	925096 12330	IPS, MS3	124.5 X 3 mm



*new*

REF	OEM		
REC925055	925055	14.3 X 2.4 mm	

*new*

REF	OEM		
REC948610	948610	39.2 X 3 mm	

*new*

REF	OEM		
REC925255	925255	64.5 X 3 mm	

*new*

REF	OEM		
REC925066	925066 12291 14213244 14012291 213244	36.2 X 3 mm	

*new*

REF	OEM		
REC858986	858986 842744		

*new*

## CUERNO ESCAPE

## EXHAUST TUBO

## CORNA DI SCARICO

## CORNE D'ÉCHAPPEMENT

REF	OEM		
REC925068	925068 23405 14023405 11991571	D4, D6	42.2 X 3 mm





## COLECTOR ESCAPE

## EXHAUST MANIFOLD

## COLLETORE SCARICO

## COLLECTEUR D'ÉCHAPPEMENT

REF	OEM		
REC838766	838766	D31, D41, D32, D300, D42, D43, D44	





## SISTEMA LUBRICACIÓN

## LUBRICATION SYSTEM

## SISTEMA LUBRIFICAZIONE

## SYSTÈME DE LUBRIFICATION

REF	OEM		
REC469846	469846 424342		





REF	OEM		
REC949659	949659 14012288 12288 925065	34.2 X 3 mm	



REF	OEM		
REC469483	469783 422581	D31, D41, D30, D40, D432, D42, D43, D44, D13, D300	



REF	OEM		
REC949657	949657 13949657 925060	D IPS	22.2 X 3 mm





## TAPONES DRENAJE

## DRAIN TAPS

## RUBINETTI

## BOUCHONS DE VIDANGE

REF	OEM		Ø
REC82744	82744	AQ60, 90, 95, 100, 105, 110, 115, 120, 130, 140, 145, 151, 165, 170, 171, 230A, 250A, 251A MB10A, 18, 20 MD19, 21, 27, 29, 32	1/8"



REF	OEM		Ø
REC82745	82745	AQ90, 95, 100, 105, 110, 115, 120, 130, 140, 145, 151, 165, 170, 171, 230A, 250A, 251A MB18, 20 AQD40 AQAD40 TMD40	1/4"





REF	OEM		
REC829592	829592	MD5C MD11C, D MD17C, D	





REF	OEM		Ø
REC807036	807036	MD1A, B • MD2A, B • MD3B MD5A, B • MD6A MD6B (Versión antigua   Old version   Versione vecchia   Ancienne version)	10 x1





REF	OEM		Ø
REC997641	949918	230A, 250A, 251A, 430, 431 500B, 501B, 570, 572 MD30, 31, 40, 41	1/4"



REF	OEM		Ø
REC947893	947893	MD31A, B MD40, 41B 2001, 2002, 2003	1/4"



REF	OEM		Ø
REC997641	947894	AQ151, 171 230A, 250A, 251A	1/4"





## MANGUITOS DE MOTOR HOSES

## MANICOTTO MOTORE

## DURITE MOTEUR



### MANGUITO

### HOSE

REF	OEM		
RM3852289	3852289	3.0 (1994-98) MD, HU, LK, NC	

### MANICOTTO

### DURITE

REF	OEM		
RM3857391	3857391	3.0 (1998-11) BY, EF, WT	

REF	OEM		
RM3852288	3852288	V6 Et V8 4.3, 5.0, 5.7	



REF	OEM		
REC3862523	3862523	V6 Et V8 (Nuevos modelos   New models   Nuovi modelli   Nouveaux modèles)	

### MANGUITO CIRCUITO REFRIGERACION CERRADO

### CLOSED COOLING SYSTEM HOSE

### MANICOTTO SYSTEMA RAFFREDDAMENTO CHIUSO

### DURITE SYSTÈME REFROIDISSEMENT FERMÉ

REF	OEM		
REC3862852	3862852	V6 Et V8 (Nuevos   News   Nuovi   Nouveaux)	

new

VOLVO

CORREAS Y COMPONENTES

BELTS & COMPONENTS

CINGHIE E COMPONENTI

COURROIES ET COMPOSANTS

PIÑÓN CIGÜEÑAL

CRANKSHAFT GEAR

PIGNONE ALBERO MOTORE

PIGNON DE VILEBREQUIN

REF	OEM	
RM855428	855428	AQ125A AQ131A, B, C, D AQ145B AQ151A, B, C 230, 250



PIÑÓN ARBOL DE LEVAS

CAMSHAFT GEAR

PIGNONE ALBERO A CAMME

PIGNON D'ARBRE À CAME

REF	OEM		PIEZAS NECESARIAS REQUIRED PARTS PARTI NECESSARIE PIÈCES NECESSAIRES
RM856239	856239 855473 831972	AQ125A AQ131 A, B, C, D AQ145B AQ151 A, B, C 230, 250	2



CORREA DISTRIBUCIÓN

TIMING BELT

CINGHIA DISTRIBUZIONE

COURROIE DE DISTRIBUTION

REF	OEM	
REC463377	463377	AQ120B AQ125A AQ131A, B, C, D AQ140A AQ145A, B AQ151A, B, C 230A, B 250A, B 251A
REC855506	855506	AQ71 A, B, C B25



TAPÓN SEGURIDAD TAPA DE CORREAS

PLUG SAFETY COVER BELTS

TAPPO SICUREZZA COPERCHIO CINGHIE

BOUCHON D'ÉTANCHÉITÉ, CARTER DE COURROIES

REF	OEM	
REC861019	861019	KAD32, 42, 43, 44, 300



KIT DISTRIBUCIÓN

TIMING BELT KIT

KIT DISTRIBUZIONE

KIT DISTRIBUTION

REF	OEM	
REC31359568	31359568 31258305 30731772	D3-110I-A, I-B, I-C, I-D, I-E, I-F D3-130A-A, A-B, A-C, I-A, I-B, I-C D3-140A-E, A-F, I-E, I-F, A-D D3-150I-D, I-E, I-F D3-160A-A, A-B, A-C, I-A, I-B, I-C D3-190A-B, A-C, I-B, I-C D3-170I-D, I-E, I-F, A-D, A-E, A-F D3-200I-D, I-E, I-F, A-D, A-E, A-F D3-220A-D, A-E, A-F, I-D, I-E, I-F



POLEA RUPTURA

RUPTURE PULLEY

PULEGGIA

POULIE

REF	OEM	
REC3860079	3860079	4.3 GI, GSI, GXI, OS 5.0 GI, GSI, GXI 5.7 GI, GSI, OS 7.4 GI, GSI Se instala bajo el alternador It is installed under the alternator È installato sotto l'alternatore À installer sous l'alternateur
RM3885250	3885250 3587858 3587859 3861010	4.3 GL, GXI, GI, OSI 5.0 GXI, GI, OSI 5.7 GI, GXI, OSI 8.1 GI, GXI, IPSCE, OSI



REC3860079







RM3885250



RODILLO TENSOR		TENSION ROLLER	TENDICINGHIA	GALET TENDEUR
REF	OEM		∅	TENSOR TENSIONER TENDICINGHIA TENDEUR
REC3582324	3582324	KAD32, 43, 44, 300 KAMD43, 44, 300 TAMD42WJ-A	95 mm	 REC3582324
REC21585053	21585053			 REC21585053
REC861563	861563	KAD32P-A, 43, 44, 300 KAMD43, 44, 300 TAMD42WJ-A		 REC861563



TENSOR CORREA ALTERNADOR D4/D6		ALTERNATOR BELT TENSIONER D4/D6	TENDICINGHIA ALTERNATORE D4/D6	TENDEUR DE COUROIE D'ALTERNATEUR D4/D6
REF	OEM			
REC22774756	22774756 21344508 3582694 3583665	D4-180, 225, 260, 300, 310 D6-280, 300, 310, 330, 370, 400, 435		

TENSOR CORREA COMPRESOR D4/D6		COMPRESSOR BELT TENSIONER D4/D6	TENDICINGHIA COMPRESSORE D4/D6	TENDEUR DE COUROIE DU COMPRESSEUR D4/D6
REF	OEM			
REC22171036	22171036 21786692 3847481 3883784 3588305 3582692	D4-260, 300 D6-350, 370, 400, 435		

POLEA COMPRESOR ALTERNADOR		ALTERNATOR COMPRESSOR PULLEY	PULEGGIA ALTERNATORE	POULIE DU COMPRESSEUR ALTERNATEUR
REF	OEM			
REC21280913	21280913 3848896 3809465 3883786 21172053	D4-260, 300 (SN -2004017297) D6-350, 370, 400, 435 (SN -2006032252)	 REC21280913	
REC3847482	3847482	D4-260, 300 (SN 2004017298+) D6-350, 370, 400, 435 (SN 2006032252+)	 REC3847482	
REC31251252	31251252 30757056 30637961	D3-110I-A, I-B, I-C D3-130A-A, I-A, A-B, I-B, A-C, I-C D3-160A-A, I-A, A-B, I-B, A-C, I-C D3-190A-B, I-B, A-C, I-C		 REC31251252

TENSÍOMETRO DISTRIBUCION		TENSIONER	TENDICINGHIA DISTRIBUZIONE	TENDEUR
REF	OEM			
REC855507	855507	AQ171 A, C 251A KAD42A KAMD42A KAD42B, KAMD42B (Para compresor   For compressor   Per compressore   Pour compresseur : -2204208023)	 REC855507	 REC831986
REC831986	831986	AQ120B, 125, 131, 140, 145, 151, 230A, 250B		

**GUÍA DE CORREAS SERPENTIN Y TENSORES****SERPENTINE BELTS & TENSIONERS GUIDE****GUIDA CINGHIE SERPENTINA E TENDICINCHIE MOTORE****GUIDE DES COURROIS SERPENTIN ET TENDEURS**

	SERPENTIN SERPENTINE SERPENTINA SERPENTIN	TENSOR TENSIONER TENDICINCHIA TENDEUR		SERPENTIN SERPENTINE SERPENTINA SERPENTIN	TENSOR TENSIONER TENDICINCHIA TENDEUR
3.0GLM-C	RM3586324		5.7GI-F, -FF, -G, -GF	RM3889124	RM3885250
3.0GLP-C, -D	RM3586325		5.7GIL-A, -B, -C, -D	RM3861500	REC3860079
3.0GLP-J, -N	REC3888177		5.7GSIL-A	RM3861500	REC3860079
3.0GXI-J	REC21132392		5.7GSIPEFS	REC3860086	REC3860079
3.0GXIC-J	REC21132392		5.7GXI-A, -B, -C, -CF, -D, -DF, -E, -EF	REC3860086	REC3860079
4.3GIPEFS	REC3860086	REC3860079	5.7GXI-320-R, GXIE-320-R	RM21399021	RM3885250
4.3GL-G, -GF	RM3889124	RM3885250	5.7GXIC-320-R, GXICE-320-R	RM21399021	RM3885250
4.3GL-J, -JF	REC21132390	RM3885250	5.7GXICE-J, -JF, -M, -MF	REC21132390	RM3885250
4.3GL-P	RM21399021	RM3885250	5.7GXIC-J, -JF	REC21132390	RM3885250
4.3GXI-A, -B, -BF, -C, -CF, -D, -DF	REC3860086	REC3860079	5.7GXICE-P	RM21399021	RM3885250
4.3GXI-E, -EF	RM3586326	REC3860079	5.7GXIC-JF	REC21132390	RM3885250
4.3GXI-F, -FF, -G, -GF	RM3889124	RM3885250	5.7GXIC-P	RM21399021	RM3885250
4.3GXI-P, -Q	RM21399021	RM3885250	5.7GXIE-J, -JF, -K, -KF, -M, -MF, -N	REC21132390	RM3885250
4.3GXIE-P, -Q	RM21399021	RM3885250	5.7GXIE-P	RM21399021	RM3885250
4.3GXI-225-R, GXIE-225-R	RM21399021	RM3885250	5.7GXI-F, -FF	RM3586326	REC3860079
4.3GXIE-J, -JF, -M	REC21132390	RM3885250	5.7GXI-G, -GF, -H, -HF	RM3889124	RM3885250
4.3GI-200-R	RM21399021	RM3885250	5.7GXI-J, -JF	REC21132390	RM3885250
4.3OSI-J, -JF	REC21132390	RM3885250	5.7GXIL-A, -B, -C, -D, -E	RM3861500	REC3860079
4.3OSI-B, -BF, -C, -CF, -D, -DF	REC3860086	REC3860079	5.7GXI-N	RM21399021	RM3885250
4.3OSI-E, -EF	RM3586326	REC3860079	5.7GXI-P	REC21132390	RM3885250
4.3OSI-G, -GF	RM3889124	RM3885250	5.7OSI-300-J, -JF	REC21132390	RM3885250
V6-200-A, -225-A, -225-E-A	RM21399021	RM3885250	5.7OSI-A, -AF, -B, -BF, -C, -CF	REC3860086	REC3860079
5.0GIPEFS, GSIPEFS	REC3860086	REC3860079	5.7OSI-D, -DF	RM3586326	REC3860079
5.0GL-H, -HF	RM3889124	RM3885250	5.7OSI-G, -GF, -E, -EF	RM3889124	RM3885250
5.0GL-J, -JF	REC21132390	RM3885250	5.7OSXI-A, AF, B, -BF, -C, -CF	REC3860086	REC3860079
5.0GIC-J, -JF	REC21132390	RM3885250	5.7OSXI-D, -DF	RM3586326	REC3860079
5.0GICE-J, -JF, -M, -MF	REC21132390	RM3885250	5.7OSXIE-J, -JF	REC21132390	RM3885250
5.0GXI-A, -B, -BF, -C, -CF, -D, -DF	REC3860086	REC3860079	5.7OSXI-E, -EF, -G, -GF	RM3889124	RM3885250
5.0GIC-225-S, GICE-225-S	RM21399021	RM3885250	5.7SI-C, -CF	REC3860086	REC3860079
5.0GXIE-270-R	RM21399021	RM3885250	5.7OSIE-300-J, -JF	REC21132390	RM3885250
5.0GXIC-270R	RM21399021	RM3885250	5.7SXI-B	REC3860086	REC3860079
5.0GXI-270-R	RM21399021	RM3885250	5.7SXI-J, -JF	REC21132390	RM3885250
5.0GXICE-270-R	RM21399021	RM3885250	V8-225-C-A, -CE-A, -C-B, -CE-B	RM21399021	RM3885250
5.0GXICE-J, -JF, -M, -MF	REC21132390	RM3885250	V8-270-A, B, -E, -A, -C-A, -CE, -A, -E, -B, -C, -B, -CE, -B	RM21399021	RM3885250
5.0GXICE-P	RM21399021	RM3885250	V8-300-A, B, -E, -A, -C-A, -CE, -A, -E, B, -C, -B, -CE, -B	RM21399021	RM3885250
5.0GXIC-J, -JF	REC21132390	RM3885250	V8-320-A, B, -E, -A, -C-A, -CE, -A, -E, -B, -C, -B, -CE, -B	RM21399021	RM3885250
5.0GXIC-P	RM21399021	RM3885250	8.1GIC-400-Q, -J, -JF	RM21132385	RM3885250
5.0GXI-E, -EF	RM3586326	REC3860079	8.1GICE-400-J, -JF	RM21132385	RM3885250
5.0GXIE-J, -JF, -K, -KF, -M, -MF, -N	REC21132390	RM3885250	8.1GICE-M, -MF, -P, -Q	RM21132385	RM3885250
5.0GXIE-P	RM21399021	RM3885250	8.1GIE-J, -JF, -K, -KF, -M, -MF, -P	RM21132385	RM3885250
5.0GXI-F, -FF, -G, -GF	RM3889124	RM3885250	8.1GI-A, -B, -BF, -H, -HF, -G, -GF	REC21132390	RM3885250
5.0GXI-J, -JF, -N	REC21132390	RM3885250	8.1GI-J, -JF	RM21132385	RM3885250
5.0GXI-P	RM21399021	RM3885250	8.1GIL-H	RM3889127	RM3885250
5.0OSI-B, -C, -CF, -D, -DF	REC3860086	REC3860079	8.1GSI-A	REC21132390	RM3885250
5.0OSI-E, -EF	RM3586326	REC3860079	8.1GXIE-J, -JF, -K, -KF, -M, -MF, -P	RM21132385	RM3885250
5.0OSIE-J, -JF	REC21132390	RM3885250	8.1GXI-A, -AF, -G, -GF, -F, -FF	REC21132390	RM3885250
5.0OSI-F, -FF, -G, -GF	RM3889124	RM3885250	8.1GXJ, -JF	RM21132385	RM3885250
5.0OSI-J, -JF	REC21132390	RM3885250	8.1GXIL-G	RM3889127	RM3885250
5.7GI-300-J, -JF, -N	REC21132390	RM3885250	8.1IPSC-E, -JF, -MF, -PF, -Q	RM3861501	RM3885250
5.7GI-300-P, -300-R	RM21399021	RM3885250	8.1IPSE-JF	RM21132385	RM3885250
5.7GI-A, -B, -BF, -C, -CF	REC3860086	REC3860079	8.1OSI-C, -CF, -D, -DF	REC21132390	RM3885250
5.7GIC-300-R	RM21399021	RM3885250	8.1OSIE-J, -JF	RM21132385	RM3885250
5.7GIC-300-J, -JF	REC21132390	RM3885250	8.1OSI-J, -JF	RM21132385	RM3885250
5.7GIC-300-P, -300-R	RM21399021	RM3885250			
5.7GICE-300-J, -JF, -M, -MF	REC21132390	RM3885250			
5.7GICE-300-P, -300-R	RM21399021	RM3885250			
5.7GI-A, -D, -DF	REC3860086	REC3860079			
5.7GI-E, -EF	RM3586326	REC3860079			
5.7GIE-300-J, -JF, -K, -KF, -M, -MF, -N	REC21132390	RM3885250			
5.7GIE-300-P, -300-R	RM21399021	RM3885250			





### GUÍA DE CORREAS SERPENTIN Y TENSORES

### SERPENTINE BELTS & TENSIONERS GUIDE

### GUIDA CINGHIA SERPENTINA E TENDICINCHIA MOTORE

### GUIDE DES COURROIS SERPENTIN ET TENDEURS

	SERPENTIN SERPENTINE SERPENTINA SERPENTIN	TENSOR TENSIONER TENDICINCHIA TENDEUR	Ø RODILLO TENSOR TENSIONER ROLLER Ø Ø RULLO TENDICINCHIA Ø GALET TENDEUR		SERPENTIN SERPENTINE SERPENTINA SERPENTIN	TENSOR TENSIONER TENDICINCHIA TENDEUR	Ø RODILLO TENSOR TENSIONER ROLLER Ø Ø RULLO TENDICINCHIA Ø GALET TENDEUR
D3-110I-A	REC30731809	REC31251252		D6	RM21405494	REC22774756	
D3-110I-B	REC30731809	REC31251252		KAD300	RM3582424	REC3582324	95 mm
D3-110I-C	REC30731809	REC31251252		KAD300A	RM3582424	REC3582324	95 mm
D3-110I-D	REC30731809	REC31251252		KAD32P-A	RM3582424	REC3582324	95 mm
D3-130A-A	REC30731809	REC31251252		KAD32P-A	REC861564	REC861563	
D3-130A-B	REC30731809	REC31251252		KAD43P-A	RM3582424	REC3582324	95 mm
D3-130A-C	REC30731809	REC31251252		KAD43P-A	REC861564	REC861563	
D3-130I-A	REC30731809	REC31251252		KAD44P-B	RM3582424	REC3582324	95 mm
D3-130I-B	REC30731809	REC31251252		KAD44P-B	REC861564	REC861563	
D3-130I-C	REC30731809	REC31251252		KAD44P-C	RM3582424	REC3582324	95 mm
D3-140A-D	REC30731809	REC31251252		KAD44P-C	REC861564	REC861563	
D3-150I-D	REC30731809	REC31251252		KAMD300	RM3582424	REC3582324	95 mm
D3-160A-A	REC30731809	REC31251252		KAMD300	REC861564	REC861563	
D3-160A-B	REC30731809	REC31251252		KAMD300-A	RM3582424	REC3582324	95 mm
D3-160A-C	REC30731809	REC31251252		KAMD300-A	REC861564	REC861563	
D3-160I-A	REC30731809	REC31251252		KAMD44P	RM3582424	REC3582324	95 mm
D3-160I-B	REC30731809	REC31251252		KAMD44P	REC861564	REC861563	
D3-160I-C	REC30731809	REC31251252		KAMD44P-A	RM3582424	REC3582324	95 mm
D3-170A-D	REC30731809	REC31251252		KAMD44P-A	REC861564	REC861563	
D3-170I-D	REC30731809	REC31251252		KAMD44P-B	RM3582424	REC3582324	95 mm
D3-190A-B	REC30731809	REC31251252		KAMD44P-B	REC861564	REC861563	
D3-190A-C	REC30731809	REC31251252		KAMD44P-C	RM3582424	REC3582324	95 mm
D3-190I-B	REC30731809	REC31251252		KAMD44P-C	REC861564	REC861563	
D3-190I-C	REC30731809	REC31251252		D9A2A MH/MP/MG (425/500/575)	REC1066823		
D3-200A-D	REC30731809	REC31251252		D9A2A MH/MP/ MG (425/500/575)	REC982570		
D3-200I-D	REC30731809	REC31251252		SN7009156811+			
D3-220A-D	REC30731809	REC31251252		D11A, B	REC982570		
D3-220I-D	REC30731809	REC31251252		D12D/C (-A, -B, -C, -D, -E, -F, -G, -H)	REC978217		
D4 (DH)	REC21407028	REC22774756					
D4	RM21405494	REC22774756					
D6 (DH)	REC21407028	REC22774756					





### GUÍA DE CORREAS BOMBA AGUA

### V-BELTS GUIDE WATER POMPE

### GUIDA CINGHIA MOTORE POMPA ACQUA

### GUIDE DES COURROIS DE POMPE D'EAU

	Alternador Alternator Alternateur	Bomba agua Water pump Pompa acqua Pompe à eau	Distribución Camshaft Distribuzione Distribuzione	Bomba agua salada Sea water pump Pompa acqua salata Pompe eau de mer	Dirección asistida Power steering Servosterzo Direction assistée	REF	OEM	Piezas necesarias Required parts Parti necessarie Pièces nécessaires
AQ60F, 90, 95, 95A, 100, 105A, 110, 115, 115A, 115B, 120, 125, 130, 130A BB115, A	✓					REC966891	966891	
AQ120A, B	✓					REC966694	966694	
AQ125A, B	✓							
AQ140A, AQ145A	✓							
AQ130B, C, D	✓					REC966891	966891	
AQ131A, B, C, D	✓	✓				REC966382	966382	
AQ145B	✓	✓				REC463377	463377	
AQ151A, B, C	✓	✓				REC966382	966382	
2.5L	✓					REC463377	463377	
AQ152	✓							
AQ165A, B, C	✓	✓				REC966694	966694	
AQ170A, B, C	✓	✓				REC966382	966382	
AQ171A, C	✓					REC855506	855506	
AQ175A	✓	✓				REC978750	978750	
AQ200B,C	✓	✓				REC978750	978750	
AQ307 GM				✓		GDY17291	967158	2
AQ200D, F	✓	✓				REC978750	978750	
AQ225A, B, C, D, E, F				✓		GDY17291	967158	2
AQ205A	✓	✓			✓	REC967111	967111	
AQ211A	✓				✓	REC967111	967111	
AQ231A, B	✓	✓				REC978750	978750	
AQ255A, B • AQ260A, B	✓	✓				REC978750	978750	
AQ271A, B, C, D • AQ280A • AQ290A	✓	✓				GDY17291	967158	2
AQ311A, B	✓	✓		✓		REC966382	966382	
230A, 250, 251	✓	✓				REC463377	463377	

	Alternador	Bomba agua	Distribución	Bomba agua salada	Dirección asistida	REF	OEM	Piezas necesarias Required parts Parti necessarie Pièces nécessaires
	Alternator Alternatore Alternateur	Water pump Pompa acqua Pompe à eau	Camshaft Distribuzione Distribution	Sea water pump Pompa acqua salata Pompe eau de mer	Power steering Servosterzo Servosterzo Direction assistée			
431					✓	REC967111	967111	
501A, B	✓	✓				REC978750	978750	
570A						REC978750	978750	
572A		✓			✓	REC967111	967111	
740A, B	✓	✓				RM967191	967191	
AQ271A, B, C, D	✓	✓				REC978750	978750	
AQ311A, B						REC967111	967111	
5.7L (V-8 350)		✓			✓	REC967111	967111	
3.0GL - 3.0GS (MD, HU, LC, LK, BY, WT)	✓	✓			✓	REC3850268	3850268	
	✓				✓	REC3853536	3853536	
	✓				✓	REC3860092	3860092	
3.0GLP-A	✓					RM3860093	3860093	
3.0GSP-A, P-B, P-C					✓	REC3857835	3857835	
		✓				REC3852106		
4.3 GL 4.3 GS	✓				✓	REC3852464	3852464	
	✓					RM3852504	3852504	
		✓				REC3852106		
4.3 Gi	✓				✓	REC3852464	3852464	
		✓				GDY15382	3852348	
5.0 FL	✓				✓	REC3858462	3858462	
	✓					REC3852106	3852106	
		✓				GDY15382	3852348	
5.0 Fi	✓				✓	REC3858462	3858462	
					✓	REC3857835	3857835	
	✓					REC3852106		
5.0 GL, BY		✓				GDY15295	978457	
BY, PJX, WT, EF	✓				✓	REC3852464	3852464	
5.7 GL MD, HU, NC		✓				REC3852106	3852336	
BY, WT, EF	✓				✓	REC3852464	3852464	
7.4Gi, GL, Gsi (PNCA, PNCM)		✓				RM3850430	3850430	
7.4Gi, GL, Gsi (LK, BY, INCCE, PNCB)		✓				RM978454	978454	
7.4Gi, GL, Gsi (BY, WT, MD, HU, NC, LK)	✓					RM3854643	3854643	
	✓	✓			✓	RM3860087	3860087	
7.4 GL (MD, HU, NC, LK)	✓					RM3852607	3852607	
8.1 Gi, Gsi	✓	✓			✓	REC21132390	3861034	
8.2GL, Gsi	✓					RM3852607	3852607	
		✓				RM978454	978454	
8.2GL, Gsi (LK, BY, WT)	✓					RM3854643	3854643	
		✓				RM3850430	3850430	
8.2GL, Gsi (PNCA, PNCM)		✓				RM3850430	3850430	
8.2 Gsi (EF)	✓	✓			✓	RM3860087	3860087	

	Alternador	Bomba agua	Circuito ref. cerrado	Dirección asistida	Compresor	REF	OEM	Piezas necesarias Required parts Parti necessarie Pièces nécessaires
	Alternator Alternatore Alternateur	Water pump Pompa acqua Pompe à eau	Raw water cooling system Circuito refrig. chiuso Circuit refroid. fermée	Power steering Servosterzo Servosterzo Direction assistée	Compressor Compresseur Compresseur			
MD1 (-M011131)	✓	✓				REC57-96834Q	952141	
MD1 (M011131+)	✓	✓				REC966990	966990	2
	✓	✓				REC966990	966990	2
MD1B MD2B						REC966906	966906	
AQDB	35-1/2"	✓				REC3852106	966916	
	40-1/2"	✓				REC966990	966990	2
	✓ (-M06274)	✓ (-M06274)				REC966914	966914	
MD2	✓ (M06275+)	✓ (M06275+)				REC3852106	966906	
	✓	✓				REC966990	966990	
MD5A, B	✓	✓				REC966990	966990	
MD5C (-M030016)	✓	✓				REC3858462	966700	
MD6A (M01234+)	✓	✓				REC966931	966931	
	✓	✓				REC966933	966933	
MD6B MD7A	✓	✓				REC966707	966707	
MD7B	✓	✓				REC966906	966906	
	35-1/2"	✓				REC966990	966990	
MD11C	51"	✓	✓	×		REC966931	966931	
MD11D	55"	✓	✓			REC966942	966942	
MD11C • MD11D	✓	✓	✓			REC966383	966383	
MD17C	✓	✓	✓	×		GDY15545	966929	
MD17C	✓	✓	✓					





	Alternador Alternator Alternatore Alternateur	Bomba agua Water pump Pompa acqua Pompe à eau	Circuito ref. cerrado Raw water cooling system Circuito refrig. chiuso Circuit refroid. fermée	Dirección asistida Power steering Servosterzo Direction assistée	Compresor Compressor Compresseur Compresseur	REF	OEM	Piezas necesarias Required parts Parti necessarie Pièces nécessaires
2001	✓					REC966903	966903	
2002 2003	✓					REC966900	966900	
2003T	✓					REC966906	966906	
MD21A	✓	✓				REC829207	829207	
MD21B	✓	✓				REC829207	829207	
MD22	✓	✓				RM966912	966912	
		✓				REC3580835	3580835	
D1-13, 20						RM3809625	3809625	
D1-30						RM3812159	3812159	
D2-40						RM21314684	21314684	
D2-55	✓					RM967114	967114	
D2-75	✓					RM3584086	3584086	
	✓					REC30731809	30731809	
D3				✓		REC22352491	22352491	
	✓					REC22283751	22283751	
		✓				REC21160912	21160912	
D4, 6	✓					RM21405494	3583729	
					✓	RM21407026	21407026	
D4 (300) D6 (400/435)					✓	REC21405493	21405493	
D8	✓					REC22954700	22954700	
MD2010A, B, C	✓					RM973534	973534	
MD2020A, B, C	✓					REC978482	978482	
MD2030A, B, C	✓					RM967114	967114	
MD2040A, B, C	✓					REC966978	966978	
AQAD30A, 31A, 40A, 40B		✓						
AQD40A, 41A	✓	✓				REC966978	966978	
MD30A, 31A, 40A								
AQAD32A	✓	✓		✓		REC966387	966387	
MD32A								
KAD32P-A		✓			✓	RM3581460	3581460	
	✓	✓				REC861564	861564	
	✓					REC977542	977542	
					✓	REC860388	860388	
KAD42	✓	✓				REC976483	976483	
	✓					REC977542	977542	
AQAD41A	✓	✓				REC966978	966978	
MD70		✓				DAY17305	958481	
	✓					REC966906	966906	
		✓				GDY17291	9671587	
MD100A	29-1/4"	✓				GDY15335	966958	
	33-1/4"	✓				REC57-36356	966974	
MD100B	✓					REC57-36356	966974	
TAMD30A, 31A, 40A, 40B, 41A	✓	✓				REC966978	966978	
TMD30A, 31A, 40A, 40B, 40C, 41A	✓	✓				REC966978	966978	
TAMD61A	✓					RM967193	967193	2
TAMD63L-A, P-A						REC866653	866653	
TAMD70B, C, D, E,						RM966953	966953	
TMD70B,C								
TAMD71A	✓					RM967193	967193	2
TAMD74A-A, A-B, C-A, C-B, L-A,						REC3827273	3827273	
L-B, P-A, P-B								
TAMD73P-A, WJ-A						REC866653	866653	
TAMD74P-A								
TAMD102A	✓					GDY15386	966870	

# PARTES DEL MOTOR ENGINE PARTS

# PARTI MOTORE PIECES MOTEUR

## JUNTAS PARA BASES GM Y FORD

## MARINE GASKETS TO GM & FORD ENGINES

## GUARNIZIONI PER MOTORI GM E FORD

## JOINTS POUR MOTEURS GM ET FORD

Los Kits están diseñados y catalogados específicamente para aplicaciones marinas. Su calidad es superior a las juntas originales.



The gaskets kits are designed and cataloged specifically for marine engine applications. Their quality is even better than the oem's.



I kit di guarnizioni sono disegnati e fabbricati specificatamente per applicazioni marine. La qualità è assolutamente paragonabile a quelle originali.

Les kits sont spécifiquement conçus et catalogués pour les applications marines. Leur qualité est supérieure à celle des joints d'origine.

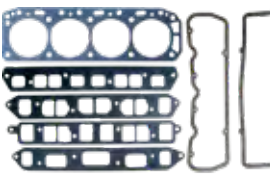



SERIE SERIAL				
1700-17099	KIT JUNTAS DE CULATA (pack individual)	CYLINDER HEAD GASKET (single-packed)	GUARNIZIONI TESTATA (quantità 1)	KIT JOINTS DE CULASSE (paquet individuel)
17100-17199	JUEGOS DE CONVERSIÓN Todas las juntas y retenes de aceite que no se encuentran en los juegos de culata. Incluye las juntas del cárter y los retenes.	CONVERSION KITS All gaskets and oil seals not found in a Head Set. This includes timing cover gaskets and seals, oil pan gaskets, and rear main bearing seals.	KIT PARTE BASSA Include tutte le guarnizioni ed i paraoli della parte bassa del motore, viene fornita anche la guarnizione della coppa dell'olio.	KITS DE CONVERSION Tous les joints d'étanchéité et joints d'huile qui ne sont pas contenus dans les kits de culasse. Comprend les joints de carter et les joints d'huile.
17200-17299	KIT DE DESCARBONIZACIÓN Todas las juntas y retenes necesarios para el trabajo de las válvulas, incluyendo la culata, la tapa de la válvula y juntas de colector de admisión y colector de escape. (Los juegos de 4 cyl no contienen las juntas del colector de admisión/escape. Deben pedirse por separado).	HEAD SETS SERIES All gaskets and seals necessary for a valve grinding job, including cylinder head gaskets, valve cover gaskets, intake & exhaust manifold gaskets (except 4 cyl intake set), and valve stem seals.	KIT PARTE ALTA (SMERIGLIO) Include tutte le guarnizioni ed i paraoli della parte alta del motore, testate, carter distribuzione, aspirazione e scarico. (Motori a 4 cyl. la guarnizione aspirazione è da ordinare separatamente).	KIT DE DÉCARBONISATION Tous les joints requis pour le travail sur les soupapes, y compris les joints de culasse, de couvercle de soupape, de collecteur d'admission et d'échappement (les kits 4 cylindres ne contiennent pas de joints de collecteur d'admission/échappement). Ils doivent être commandés séparément.
17300-17399	KIT DE COLECTOR DE ADMISIÓN Juntas de la parte de admisión del colector, retenes y juntas de la base del distribuidor.	INTAKE MANIFOLD SETS Intake manifold side gaskets, intake manifold end seals, and distributor mounting gasket.	KIT GUARNIZIONE ASPIRAZIONE Guarnizioni laterali del collettore di aspirazione, guarnizioni e guarnizioni della base del distributore.	KIT DE COLLECTEUR D'ADMISSION Joints de collecteur d'admission, joints d'étanchéité et joints de base de distributeur.
17400-17499	KIT DE COLECTOR DE ESCAPE (de colector a culata)	EXHAUST MANIFOLD (manifold-to-cylinder head gaskets)	KIT GUARNIZIONE SCARICO (dalla testata al collettore)	KIT COLLECTEUR D'ÉCHAPPEMENT (collecteur à la culasse)
17700-17749	KIT DE CONTRARROTACIÓN RETÉN TRASERO DEL CIGÜENAL Retenes traseros del cigüeñal diseñados para motores de rotación opuesta a la normal. (Retenes de rotación normal incluidos en el set de conversión)	REVERSE ROTATION REAR MAIN BEARING SEAL SETS Rear main bearing seals designed to seal a crankshaft which rotates in the opposite direction from normal (Standard rotation seal is included in conversion set)	PARAOLIO MOTORI CONTROROTANTI ALBERO MOTORE Nel motori rotazione STD il paraolio viene già incluso nel kit della parte bassa. (Guarnizioni a rotazione normale incluse nel set di conversione)	KIT CONTRE-ROTATION JOINTS D'HUILE DE VILEBREQUIN ARRIÈRE Joints de vilebrequin arrière conçus pour les moteurs à contre-rotation (joints à rotation normale inclus dans le kit de conversion).
17750-17799	KIT DE RETENES TAPA DEL CIGÜENAL DE CONTRARROTACIÓN Retenes de la tapa del cigüeñal diseñados para motores de rotación opuesta a la normal. (Retenes de rotación normal incluidos en el set de conversión).	REVERSE ROTATION TIMING COVER SEAL SETS SERIES Timing cover seals designed to seal crankshaft which rotates in the opposite direction from normal (standard rotation seal is included in Conversion set and Timing cover set)	PARAOLIO CARTER DISTRIBUZIONE CONTROTOTANTI Guarnizioni del coperchio dell'albero a gomiti progettate per motori controrotanti (le guarnizioni per la rotazione normale sono incluse nel set di conversione).	KIT DE JOINTS DE COUVERCLE DE VILEBREQUIN CONTRE-ROTATIF Joints de couvercle de vilebrequin conçus pour les moteurs à contre-rotation (joints à rotation normale inclus dans le kit de conversion).
17900-17949	KIT DE TAPA VÁLVULA Todas las juntas de las tapas de las válvulas para sellar el motor.	VALVE COVER SET SERIES All valve cover or push rod cover gaskets (and grommets if required) required to seal one engine.	KIT COPERCHIO PUNTERIE Tutte le guarnizioni del coperchio della valvola per sigillare il motore.	KIT DE COUVERCLE DE SOUPAPE Tous les joints de couvercle de soupape pour l'étanchéité du moteur.
17950-17999	KIT DE CÁRTER Todas las juntas y retenes del cárter de aceite, o la junta del cárter de aceite de goma moldeada de una pieza, necesarias para sellar un motor.	OIL PAN SETS SERIES All oil pan gaskets & seals, or one-piece molded rubber oil pan gasket, required to seal one engine.	GUARNIZIONE COPPA DELL'OLIO Tutte le guarnizioni e le tenute della coppa dell'olio, o la guarnizione in gomma stampata in un unico pezzo, necessarie per sigillare un motore.	KIT DE CARTER D'HUILE Tous les joints de carter d'huile, ou un joint de carter d'huile en caoutchouc moulé d'une seule pièce, nécessaires à l'étanchéité d'un moteur.



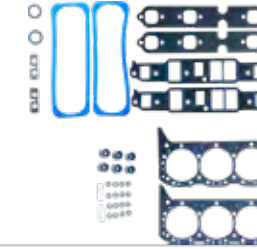
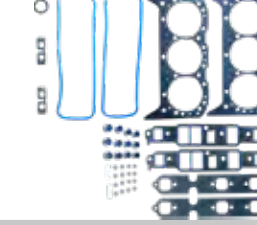

### 3.0 GS (135-150 HP), GL (135 HP), GXI (150 HP)

REF	CULATA	CYLINDER HEAD	TESTATA	CULASSE
 REC17000	JUNTA CULATA	CYLINDER HEAD	GUARNIZIONE TESTATA	JOINT DE CULASSE
 REC17200	KIT JUNTAS SUPERIOR	GASKET HEAD SET	KIT PARTE ALTA	KIT DE JOINTS SUPÉRIEURS
REF	INFERIOR	CONVERSION	PORTE BASSA	CONVERSION
 REC17102	KIT JUNTAS Retén 1 pieza. Junta cárter 1 pieza.	GASKET SET 1 piece rear main bearing seal 1 piece oil pan gasket	KIT Paraolio in 1 pz. Guarnizione coppa dell'olio in 1 pz.	KIT JOINTS INFÉRIEURS Joint spi 1 pièce. Joint de carter 1 pièce.





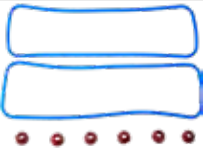

	REF	COLECTOR ADMISIÓN-ESCAPE	MANIFOLD INTAKE & EXHAUST	ASPIRAZIONE-SCARICO	ADMISSION ET ÉCHAPPEMENT
	REC27-815528	Junta (6229718+) sólo 3.0 LX	Gasket (6229718+) only 3.0 LX	Guarnizione (6229718+) solo 3.0 LX	Joint (6229718+) 3.0 LX uniquement
	REF	TAPA VÁLVULAS	VALVE COVER	COPERCHIO VALVOLE	CACHE CULBUTEUR
	REC17900	Junta	Gasket	Guarnizione	Joint
	REF	TAPA EMPUJADORES	PUSH ROD COVER	COPERCHIO ASTE PUNTERIE	COUVERCLE
	REC17903	Junta	Gasket	Guarnizione	Joint

4.3 GI (205 HP); 4.3 GL (190 HP); 4.3 GS (205 HP); 4.3 GXI (225 HP)  
430, 430 DP (155 HP)  
431 (180 HP); 431 (205 HP)  
432 DP (164 HP)  
434 DP (187 HP)

	REF	CULATA	CYLINDER HEAD	TESTATA	CULASSE
	REC17010	Se necesitan dos	2 required	Necessarie 2	Deux sont nécessaires
	REC17210	Motor sin eje equilibrado. Incluye juntas tapa válvulas y retenes.	Engine without balance shaft. Valve cover gaskets and premium valve stem seals included.	Motore senza asse bilanciato. Include guarnizione coperchio punterie e paraoli valvole.	Moteur sans arbre d'équilibrage. Comprend les joints de cache culbuteur et les joints d'étanchéité.
	REC17211	Motor con eje equilibrado. Incluye juntas tapa válvulas y retenes.	Engine with balance shaft. Valve cover gaskets and premium valve stem seals included.	Motore con asse bilanciato. Include guarnizione coperchio punterie e paraoli valvole.	Moteur avec arbre d'équilibrage. Comprend les joints de cache culbuteur et les joints d'étanchéité.
	REF	INFERIOR	CONVERSION	PARTE BASSA	PARTIE BASSE
	REC17116	Retén de 1 pieza.	1 piece rear gasket.	Paraolio posteriore in 1 pz	joint spi 1 pièce
	REF	COLECTOR ADMISIÓN-ESCAPE	MANIFOLD INTAKE & EXHAUST	ASPIRAZIONE-SCARICO	ADMISSION ET ÉCHAPPEMENT
	REC17310	Junta Admisión-Escape	Intake-Exhaust Gasket	Guarnizione aspirazione	Joint d'admission et d'échappement
	REC824326002	Junta Admisión Vortec (2 unid.)	Intake Gasket Vortec (2 units)	guarnizione aspirazione Vortec (2 unità)	Joint d'admission Vortec (2 pièces)
	REC27-99757	Kit juntas colector - escape	Exhaust gasket set	Kit guarnizione scarico	Kit joints collecteur d'échappement

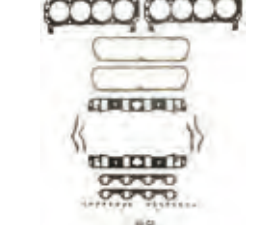
REF	CARTER	OIL PAN	COPPA DELL'OLIO	CARTER D'HUILE
	REC17971 1 junta carter (Retén 1 pieza)	1 piece oil pan gasket (1 piece seal)	Guarnizione coppa in 1 pz (paraolio 1 pz)	1 joint de carter (Joint spi 1 pièce)
	REC27-142471 1 Junta Carter de goma (-2008)	1 rubber oil pan gasket (-2008)	Guarnizione 1 pz (-2008)	1 Joint de carter en caoutchouc (-2008)
	REC21124852 1 Junta Carter de goma (2008+)	1 rubber oil pan gasket (2008+)	Guarnizione 1 pz (2008+)	1 Joint de carter en caoutchouc (2008+)
REF	TAPA VÁLVULAS	VALVE COVER	COPERCHIO VALVOLE	CACHE CULBUTEUR
	REC17920 Motor sin eje equilibrado.	Engine without balance shaft	Motore senza asse equilibrato.	Moteur sans arbre d'équilibrage.
	REC17921 Motor con eje equilibrado.	Engine with balance shaft	Motore con asse equilibrato.	Moteur avec arbre d'équilibrage





**5.0 FI (220 HP); 5.0FL (190 HP)  
215 (215 HP); 220 (220 HP); 225 (225 HP)  
FORD**

REF	CULATA	CYLINDER HEAD	TESTATA	CULASSE
	FEL17060 Se necesitan dos	2 required	Necessarie 2	Deux sont nécessaires
	FEL17260 Incluye retenes de válvulas.	Premium valve stem seals included.	Include paraoli valvole.	Comprend les joints de queue de soupape.
	FEL17261 Con tapa válvulas de aluminio. Incluye retenes de válvulas.	With cast aluminum valve covers. Premium valve stem seals included.	Con coperchio punterie in alluminio. Include paraolio valvole.	Avec le cache culbuteur en Aluminium. Comprend les joints de queue de soupape.
REF	INFERIOR	CONVERSION	PARTE BASSA	PARTIE BASSE
	FEL17161 Retén 1 piezas, 1 pieza junta cárter. Incluye junta de cárter.	1 piece rear main bearing seal & 1 piece oil pan gasket. Rubber oil pan gasket included.	Paraolio in 1 pz, 1 pz guarnizione coppa dell'olio. Include guarnizione coppa.	Joint spi 1 pièce Joint de carter 1 pièce. Comprend le joint de carter.
	FEL17160 Retén 2 piezas, 4 piezas junta cárter.	2 piece rear main bearing seal & 4 piece oil pan gasket.	Paraolio in 2 pz, 4 pz guarnizione coppa dell'olio.	Joint spi 2 pièces Joint de carter 4 pièces.
REF	COLECTOR ADMISIÓN-ESCAPE	MANIFOLD INTAKE & EXHAUST	ASPIRAZIONE-SCARICO	ADMISSION ET ÉCHAPPEMENT
	FEL17360 Kit junta admisión	Intake gasket set	Kit guarnizioni aspirazione	Kit joints d'admission
	REC3852455 Junta escape	Exhaust gasket	Guarnizione scarico	Joints collecteur d'échappement

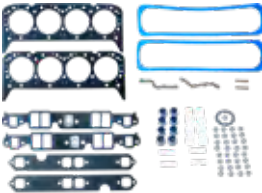

REF	CARTER	OIL PAN	COPPA DELL'OLIO	CARTER D'HUILE
	FEL17995 Retén 2 piezas	2 pièces seal	Paraolio 2 pz	Joint spi 2 pièces
	FEL17997 1 pieza junta de goma.	1 piece oil pan gasket	Guarnizione 1 pz	1 Joint de carter de caoutchouc.
REF	TAPA VÁLVULAS	VALVE COVER	COPERCHIO VALVOLE	CACHE CULBUTEUR
	FEL17945 Con tapa de válvulas de acero	With iron valve cover	Con coperchio valvole in acciaio	Cache culbuteur en acier
	FEL17946 Con tapa válvulas de aluminio.	With cast aluminium valve covers.	Con coperchio valvole in alluminio.	Cache culbuteur en Aluminium

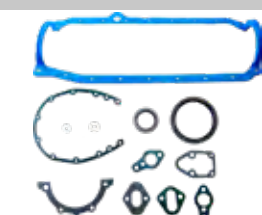

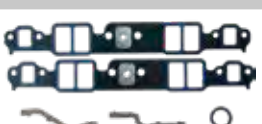







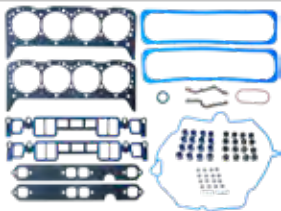

5.0GX1 (270HP)  
 AQ200 (200 HP); AQ211 (210 HP); AQ225 (225 HP); AQ231 (229 HP)  
 BB225 (225HP); BB231 (229 HP)  
 500 DP (187 HP); 500 DP (190 HP)  
 501, 501 DP (204 HP); 501, 501 DP (205 HP)

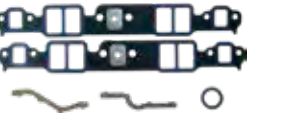
REF	CULATA	CYLINDER HEAD	TESTATA	CULASSE
	REC17020 3853380 Se necesitan dos	2 required	Ne servono 2	2 sont nécessaires
	REC17224 Tornillo centro tapa válvulas. Incluye retenes válvulas.	With center bolt desing valve covers. Premium valve stem seals included.	Viti coperchio punterie al centro. Include paraoli valvole.	Cache culbuteur avec les vis centrales. Comprend les joints de queue de soupapes.
	REC17220 Tornillo en el lateral tapa válvulas. Incluye retenes válvulas.	Rim bolt desing valve covers. Premium valve stem seals included.	Viti coperchio punterie nel perimetro. Include paraoli valvole.	Cache culbuteur avec les vis laterales. Comprend les joints de queue de soupapes.
REF	INFERIOR	CONVERSION	PORTE BASSA	PARTIE BASSE
	REC17125 Retén de 1 pieza y junta cárter de 1 pieza Incluye junta de cárter.	One-piece rear main bearing seal Et 1 piece oil pan gasket. Oil pan gasket included.	Paraolio in 1 peze e guarnizione coppa in 1 peze. Include paraolio coppa.	Joint spi 1 pièce. Joint de carter 1 pièce. Comprend le Joint spi.
	REC17120 Retén de 2 piezas y junta cárter de 4 piezas	Two-piece rear main bearing seal Et 4 pieces oil pan gasket.	Paraolio in 2 peze e guarnizione coppa in 4 pezi.	Joint spi 2 pièces et joint de carter 4 pièces.
REF	COLECTOR ADMISIÓN-ESCAPE	MANIFOLD INTAKE & EXHAUST	ASPIRAZIONE-SCARICO	ADMISSION ET ECHAPPEMENT
	REC17320 856365 Kit junta admisión-escape.	Intake-exhaust gasket set.	Kit guarnizioni aspirazione - scarico.	Kit joints d'admission.

	REC27-807473A1	3857662	JUNTA ADMISIÓN Vortec (2 unid.) Junta de plástico.	INTAKE GASKET Vortec (2 units). Gasket in plastic.	GUARNIZIONE ASPIRAZIONE Vortec necessita 2 pz. Guarnizione in plastica	JOINT ADMISSION Vortec (2 unités). Joint en plastique.
	REC27-33395	856034	Kit juntas colector escape	Oil pan - exhaust gasket set.	Kit guarnizione Coppa olio - scarico.	Kit joints collecteur d'échappement.
	REF		CARTER	OIL PAN	COPPA DELL'OLIO	CARTER D'HUILE
	REC17982	3856138	Junta cárter 1 pieza. Junta de cárter incluida.	1 piece oil pan gasket. Molded rubber oil pan gasket included.	Guarnizione in 1 pz. Guarnizione coppa included.	Joint de carter 1 pièce.
	FEL17983		Junta 1 pieza. Para motores con retén trasero de 2 piezas.	1 piece molded rubber gasket for engines with Two-piece rear main bearing sea.	Guarnizione in 1 pz, paraolio posteriore in 2 px.	Joint de carter 1 pièce pour moteurs avec Joint spi arrière 2 pièces.
	REC17980	855729	Varilla aceite de BABOR con retén trasero de 2 piezas y junta cárter de 4 piezas.	PORT dipstick with 2-piece rear main bearing seal & 4-piece oil pan gasket.	Asticella olio a SINISTRO con paraolio posteriore in 2 pz. e guarnizione coppa da 4 pz.	Jauge d'huile à BABORD avec Joint spi arrière en 2 pièces et joint de carter en 4 pièces.
	REC17981		Varilla aceite de ESTRIBOR con retén trasero de 2 piezas y junta cárter de 4 piezas.	STARBOARD dipstick with 2-piece rear main bearing seal & 4-piece oil pan gasket	Asticella olio DESTRO con paraolio posteriore in 2 pz e guarnizione coppa da 4 pz.	Jauge d'huile à TRIBORD avec Joint spi arrière en 2 pièces et joint de carter en 4 pièces.
	REF		RETÉN TRASERO CIGÜEÑAL	Crankshaft rear seal	PARAOLIO POSTERIORE ALBERO MOTORE	JOINT AIRRÈRE DE VILEBREQUIN
	FEL17725		Retén partido. Contrarrotación. De goma; dos piezas.	Split seal Rev. rotation, rubber; two-piece	Controrotazione in 2 pz. in gomma.	Joint contre-rotation en 2 pièces, en caoutchouc.
	REF		TAPA VÁLVULAS	VALVE COVER	COPERCHIO VALVOLE	COUVERCLE SOUPAPE
	REC17931	3852687	Tornillo centro tapa válvulas con juntas.	Molded rubber gaskets incl.	Coperchio punterie con viti centrali.	Fixation par vis centrale
	REC17930	835096	Tornillo en el canto.	Rim bolt desing	Coperchio punterie con viti nel perimetro.	Fixation par 4 vis laterales.
	REF		RETÉN DISTRIBUCIÓN	OIL SEAL TIMING COVER	PARAOLIO DISTRIBUZIONE	JOINT SPI DE DISTRIBUTION
	REC3853341	3853341	Reten contrarrotación. Motor sin tapa distribución de plástico.	Reverse rotation oil seal. Engines without plastic timing cover.	Paraolio controrrotante. Motore senza carter distribuzione in plastica.	Joint contre rotation pour moteur sans carter de distribution en plastique.



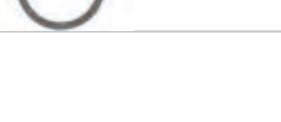



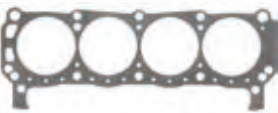

**AQ260 (260 HP); AQ271 (270 HP); AQ271 (275 HP); AQ290 (290 HP); AQ311 (307 HP); BB260, BB261 (260 HP); 5.7 Gi (250 HP); 5.7 GL (215 HP), GXI (320HP); 570, 570 DP (245 HP); 571 (273 HP); 572 (225HP)**

	REF	CULATA	CYLINDER HEAD	TESTATA	CULASSE	
	REC17030	3853380	Se necesitan dos	2 required	Ne servono 2	2 sont nécessaires
	REC17214		Tornillo centro tapa válvulas. Incluye retenes válvulas.	With center bolt desing valve covers. Premium valve stem seals included.	Viti coperchio punterie al centro. Include paraoli valvole.	Cache culbuteur avec les vis centrales. Comprend les joints de queue de soupapes.
	REC17230		Tornillo en el lateral tapa válvulas. Incluye retenes válvulas.	Rim bolt desing valve covers. Premium valve stem seals included.	Viti coperchio punterie nel perimetro. Include paraoli valvole.	Cache culbuteur avec les vis laterales. Comprend les joints de queue de soupapes.

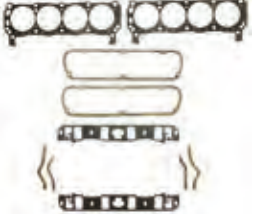
	REC17232	Juntas del colector admisión de plástico. Retenes válvulas incluidos. VORTEC	Gasket head set with plastic intake manifold gaskets. Premium valve stem. Seals incl. VORTEC	Kit con guarnizione aspirazione in plastica. Paraoli valvole inclusi. VORTEC	Kit joint collecteur aspiration de plastique. Comprend les joints de queue de soupapes. VORTEC
REF		INFERIOR	CONVERSION	PARTE BASSA	CONVERSION
	REC17125	Retén de 1 pieza y junta cárter de 1 pieza Incluye junta de cárter.	One-piece rear main bearing seal & 1 piece oil pan gasket. Oil pan gasket included.	Paraolio in 1 peze e guarnizione coppa in 1 peze. Include paraolio coppa.	Joint spi 1 pièce. Joint de carter 1 pièce. Comprend le Joint spi.
	FEL17124	Con tapa de distribución de plástico, retén de 1 pieza y junta cárter de 1 pieza.	Engine with plastic timing cover, with 1 piece bearing seal & 1 piece oil pan gasket.	Cárter distribuzione in plastica, paraolio in 1 pz e guarnizione coppa olio in 1 pz.	Pour carter de distribution en plastique, joint arrière monobloc et joint de carter monobloc. Joint de carter inclus.
	REC17120	Retén de 2 piezas y junta cárter de 4 piezas	Two-piece rear main bearing seal & 4 pieces oil pan gasket.	Paraolio in 2 peze e guarnizione coppa in 4 pezzi.	Joint spi 2 pièces et joint de carter 4 pièces.
REF		COLECTOR ADMISION-ESCAPE	MANIFOLD INTAKE & EXHAUST	ASPIRAZIONE-SCARICO	ADMISSION ET ECHAPPEMENT
	REC17320	Kit Juntas Admisión-Escape	Intake-Exhaust Gasket Set	Kit guarnizioni aspirazione - SCARICO	Kit joints d'admission
	REC27-807473A1	3857662 JUNTA ADMISION Vortec (2 unid.) Junta de plástico.	INTAKE GASKET Vortec (2 units) Gasket in plastic.	GUARNIZIONE Vortec necessita 2 pz guarnizione in plastica	JOINT ADMISSION Vortec (2 pièces). Joint en plastique.
	REC27-33395	Kit juntas colector -escape	Oil pan - Exhaust gasket set	Kit guarnizione coppa olio - SCARICO	Kit joints collecteur-d'échappement
REF		CARTER	OIL PAN	COPPA DELL'OLIO	CARTER D'HUILE
	REC17982	Junta cárter 1 pieza. Incluye Junta de cárter.	1 piece oil pan gasket. Molded rubber oil pan gasket included.	Guarnizione in 1 pz. Incluye guarnizione coppa.	Joint de carter 1 pièce. Comprend joint de carter.
	FEL17983	1 pieza junta para motores con retén trasero de 2 piezas.	1 piece molded rubber gasket for engines with 2-piece rear main bearing seal.	Guarnizione in 1 pz, paraolio posteriore in 2 px.	Joint 1 pièce pour moteurs avec Joint spi arrière 2 pièces.
	REC17980	855729 Varilla aceite de BABOR con retén trasero de 2 piezas y junta cárter de 4 piezas.	PORT dipstick with 2-piece rear main bearing seal & 4-piece oil pan gasket.	Asticella olio a SINISTRO con paraolio posteriore in 2 pz. e guarnizione coppa da 4 pz.	Jauge d'huile à BABORD avec Joint spi arrière en 2 pièces et joint de carter en 4 pièces.
	REC17981	Varilla aceite de ESTRI-BOR con retén trasero de 2 piezas y junta cárter de 4 piezas.	STARBOARD dipstick with 2-piece rear main bearing seal & 4-piece oil pan gasket	Asticella olio DESTRO con paraolio posteriore in 2 pz e guarnizione coppa da 4 pz.	Jauge d'huile à TRIBORD avec Joint spi arrière en 2 pièces et joint de carter en 4 pièces.
REF		RETÉN TRASERO CIGÜENAL	Crankshaft rear seal	PARAOLIO POSTERIORE ALBERO MOTORE	JOINT AIRRÈRE DE VILEBREQUIN
	FEL17725	Retén partido. Contrarrotación. De goma; dos piezas.	Split seal Rev. rotation, rubber; two-piece	Controrotazione in 2 pz. in gomma.	Joint en caoutchouc en 2 pièces pour moteur en contre rotation.

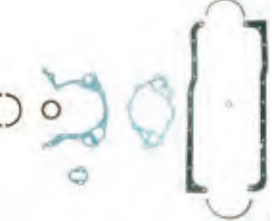
REF	TAPA VÁLVULAS	VALVE COVER	COPERCHIO VALVOLE	CACHE CULBUTEUR
 REF REC17931 3852687	Tornillo centro tapa válvulas con juntas.	Molded rubber gaskets incl.	Coperchio punterie con viti centrali.	Cache culbuteur avec vis centrales.
 REF REC17930 835096	Tornillo en el canto.	Rim bolt desing	Coperchio punterie con viti nel perimetro.	Cache culbuteur avec vis laterales.
REF	RETÉN DISTRIBUCIÓN	OIL SEAL TIMING COVER	PARAOILIO DISTRIBUZIONE	JOINT SPI DE DISTRIBUTION
 REF REC3853341 3853341	Reten contrarrotación. Motor sin tapa distribución de plástico.	Reverse rotation oil seal. Engines without plastic timing cover.	Paraolio controrrotante. Motore senza carter distribuzione in plastica.	Joint contre rotation pour moteur sans carter de distribution en plastique.

### 5.8 FL (235 HP); 5.8 FSI (265 HP); 240 (240 HP)









REF	CULATA	CYLINDER HEAD	TESTATA	CULASSE
 REF FEL17060	Se necesitan dos.	2 required.	Ne servono 2.	2 sont nécessaires.
 REF FEL17260	Con retenes valvula.	Premium valve stem.	Include paraolio valvole.	Comprend les joints de queue de soupapes.
 REF FEL17261	Con tapa válvulas de aluminio. Incluye retenes de válvulas.	With cast aluminum valve covers. Premium valve stem seals included.	Con coperchio punterie in alluminio. Include paraolio valvole.	Avec le cache culbuteur en Aluminium. Comprend les joints de queue de soupape.
REF	INFERIOR	CONVERSION	PARTE BASSA	PARTIE BASSE
 REF FEL17166	Retén 1 pieza, 1 pieza junta cárter.	1 piece rear main bearing seal & 1 piece oil pan gasket	Paraolio in 1 pz, 1 pz guarnizione coppa dell'olio.	Joint spi 1 pièce et joint de carter 1 pièce.
 REF FEL17165	Retén 2 piezas, 4 piezas junta cárter.	2 piece rear main bearing seal & 4 piece oil pan gasket,	Paraolio in 2 pz, 4 pz guarnizione coppa dell'olio.	Joint spi 2 pièces et joint de carter 4 pièces.
REF	COLECTOR ADMISION-ESCAPE	MANIFOLD INTAKE & EXHAUST	ASPIRAZIONE-SCARICO	ADMISSION ET ÉCHAPPEMENT
 REF FEL17360	Kit Juntas Admisión.	Intake gasket set.	Kit guarnizioni aspirazione -.	Kit joints admission
 REC3852455 3852455	Junta escape.	Exhaust gasket.	Guarnizione scarico.	Joints de collecteur d'échappement.
REF	CARTER	OIL PAN	COPPA DELL'OLIO	CARTER D'HUILE
 REF FEL17996	Cárter 4 piezas.	4 piece oil pan gasket.	4 pz coppa.	Joint de carter en 4 pièces.
 REF FEL17998	Cárter 1 pieza	Oil Pan 1 piece	1 pz. coppa.	Joint en 1 pièce.

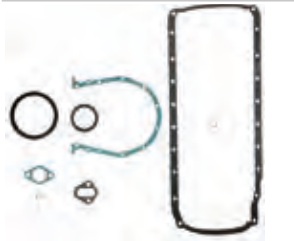
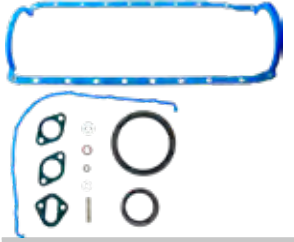
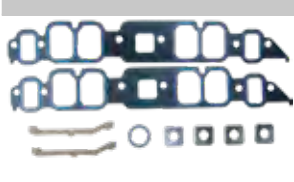



REF	TAPA VÁLVULAS	VALVE COVER	COPERCHIO VALVOLE	CACHE CULBUTEUR
FEL17945	Con tapa de válvulas de acero	With iron valve cover	Con coperchio valvole in acciaio	Cache culbuteur en acier
FEL17946	Con tapa válvulas de aluminio.	With cast aluminium valve covers.	Con coperchio valvole in alluminio.	Cache culbuteur en Aluminium







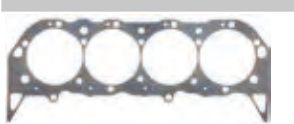

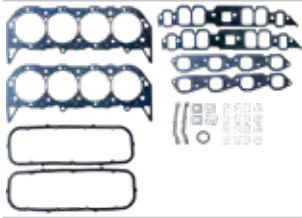
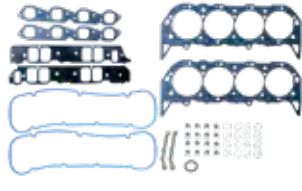

**7.4 GI (330 HP GEN. V); 7.4 GL (300 HP GEN. V); 7.4 GSI (385 HP GEN. V)  
740 (300 HP GEN. IV); 740 DP (300 HP GEN. IV); 740 DP (300 HP GEN. V)**

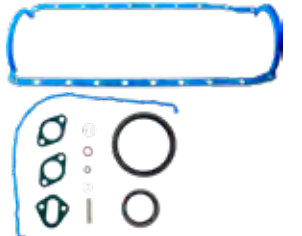
REF	CULATA	CYLINDER HEAD	TESTATA	CULASSE
REC17040	856575 Gen IV exc. H.O. Se necesitan dos	Gen IV exc. H.O. 2 required	Gen IV escluso H.O. Necessarie 2	Gen IV exc. H.O. Deux sont nécessaires.
REC17042	3853511 Gen IV & V. Se necesitan 2.	Gen IV & V. 2 required	Gen IV e V. Necessarie 2	Gen IV et V. Deux sont nécessaires.
REC17240	Gen IV exc. H.O. con admisión ovalada. Se incluye retenes de válvula.	Gen IV exc. H.O. with oval intake ports. Premium valve stem seals included.	Gen IV escluso H.O. con aspirazione ovale. Inclusi paraoli valvole.	Gen IV exc. H.O. avec admission ovale. Joints de queue de soupape inclus.
REC17242	Gen V EFI y H.O. Se incluye retenes de válvula. Gen VI. EFI y H.O. juntas de goma de tapa válvulas y retenes incluidos	Gen V. EFI or H.O. ; premium valve stem seals incl. Gen VI, EFI & H.O. molded rubber valve cover gaskets and premium valve stem seals incl.	Gen V EFI e H.O. Include paraoli valvole. Gen VI, EFI e H.O., guarnizione coperchio punterie e paraoli inclusi.	Gen V EFI et H.O. Joint de soupape inclus. Gen VI. EFI et H.O. joints de couvre-soupapes et joints de queue de soupape inclus.
REC17243	Gen V & VI solo H.O. con admisión rectangular, juntas tapa válvulas y retenes incluidos.	Gen V & VI, H.O. only, with rectangular intake ports valve cover gaskets and premium valve stem seals incl.	Gen V e VI solo H.O. con aspirazione rettangolare, guarnizione coperchio punterie e paraoli inclusi.	Gen V et VI H.O. uniquement avec admission rectangulaire, joints de cache culbuteur et joints de queue de soupape inclus.
FEL17205	Gen VI sólo EFI Juntas de tapa válvulas y retenes incluidos.	Gen VI, EFI only, valve cover gaskets and premium valve stem seals incl.	Gen VI, solo EFI guarnizione rettangolare, guarnizione coperchio punterie e paraoli inclusi.	Gen V EFI uniquement. Joints de cache culbuteur et joints de queue de soupape inclus.
REF	INFERIOR	CONVERSION	PORTE BASSA	PARTIE BASSE
REC17140	Gen IV con retén trasero de dos piezas y junta cárter de 4 piezas.	Gen IV with two piece rear main bearing seal & four piece oil pan gasket.	Gen IV con paraolio posteriore in 2 pz. e guarnizione coppa dell'olio in 4 pz.	Gen V avec joint arrière en 2 parties et joint de carter en 4 parties.

	FEL17145	Gen V con retén trasero de una pieza y junta cárter de 1 pieza. Junta cárter incluida.	Gen V with one piece rear main bearing seal & one piece oil pan gasket. Oil pan gasket included.	Gene V con paraolio posteriore in 1 pz. e guarnizione coppa dell'olio in 1 pz.	Gen V avec joint arrière en 1 pièce et joint de carter en 1 pièce. Joint de carter inclus.	
	REC17146	Gen VI con retén trasero de una pieza y junta cárter de 1 pieza. Junta cárter incluida.	Gen VI with one piece rear main bearing seal & one piece oil pan gasket. oil pan gasket. incl.	Gen VI con paraolio posteriore in 1 pz. e guarnizione coppa dell'olio in gomma in 1 pz.	Gen VI avec joint à lèvres arrière en une seule pièce et joint de carter en 1 pièce. Joint de carter inclus.	
	REF	COLECTOR ADMISIÓN-ESCAPE	MANIFOLD INTAKE & EXHAUST	ASPIRAZIONE-SCARICO	ADMISSION ET ÉCHAPPEMENT	
	REC17341	Gen IV, V y VI sólo H.O. con admisión rectangular. Gene IV, excl. H.O. con admisión rectangular.	Gen IV, V & VI, H.O. only with rectangular intake ports. Gen IV excl. H.O. with rect. intake ports.	Gen IV, V e VI solo H.O. con aspirazione rettangolare. Gen IV escluso H.O. con aspirazione rettangolare.	Gen IV, V et VI uniquement H.O.: avec admission rectangulaire. Gen IV, exc. H.O. avec admission rectangulaire.	
	REC17340	856616	Gen IV, excl. H.O. con admisión oval. Gen V y VI y H.O. con admisión ovalada.	Gen IV excl. H.O. with oval intake ports. Gen V & VI, & H.O. with oval intake ports.	Gen IV escluso H.O. con aspirazione ovale. Gen V e VI e H.O. con aspirazione ovale.	Gen IV, exc. H.O. avec admission ovale. Gen V, VI et H.O. avec admission ovale.
	REC27-46820	3852472	KIT JUNTA ESCAPE Gen IV, V y VI.	EXHAUST GASKET SET Gen IV, V & VI	KIT GUARNIZIONI SCARICO Gen IV, V e VI	KIT JOINTS D'ÉCHAPPEMENT Gen IV, V et VI.
	REF	CARTER	OIL PAN	COPPA DELL'OLIO	CARTER D'HUILE	
	FEL17985	856889	Gen IV, 4 piezas.	Gen IV, 4 pieces gasket.	GEN IV, 4 pz.	Gen IV, 4 pièces.
	FEL17986	3853510	Gen V & VI 1 pieza, incluye junta de goma.	Gen V & VI 1 piece oil pan gasket. Rubber gasket included.	Gen V & VI 1 pz, guarnizione in gomma inclusa.	Gen V et VI 1 pièce. Comprend joint en caoutchouc.
	REF	RETÉN TRASERO CIGÜENAL	Crankshaft rear seal	PARAOLIO POSTERIORE ALBERO MOTORE	JOINT SPI ARRIERE DE VILEBREQUIN	
	REC26-14756	Gen IV. Retén Contrarrotación dos pieza.	Gen IV. Reverse rotation oil seal Two- pieces	Gen IV. Controrotante in 2 pz.	Gen IV. Joint spi contre-rotatif en 2 parties.	
	REF	TAPA VÁLVULAS	VALVE COVER	COPERCHIO VALVOLE	CACHE CULBUTEUR	
	REC17935	856626	Gen IV	Gen IV	Gen IV	Gen IV
	REC17937	3853513	Gen V & VI	Gen V & VI	Gen V e VI	Gen V et VI

## 820 DPX (385 HP GEN. V)

REF	CULATA	CYLINDER HEAD	TESTATA	CULASSE		
	FEL17049	Gen IV sólo H.O. super medida. Se necesitan 2.	Gen IV H.O. only super bore 2 required	Gen IV solo H.O. maggiorata. Necessarie 2	Gen IV seulement H.O. super taille. 2 sont nécessaires.	
	REC17048	3853587	Gen IV, V & VI. Se necesitan 2.	Gen IV, V & VI. 2 required	Gen IV, V e VI. Necessita 2	Gen IV, V et VI. 2 sont nécessaires.

	REC17248	Gen IV. Se incluye retenes de válvula y juntas tapa válvulas.	Gen IV. Premium valve stem seals & valve cover gaskets included.	Gen IV. Include paraolio e guarnizione del coperchio valvola	Gen IV. Les joints de cache culbuteur et de queue de soupape sont inclus.
	REC17207	Gen V & VI solo EFI. Se incluye retenes de válvula y juntas tapa válvulas.	Gen V & VI EFI only. Premium valve stem seals & valve cover gaskets included.	Gen V e VI solo EFI. Include paraolio e guarnizione del coperchio valvola	Gen V & VI EFI uniquement. Les joints de cache culbuteur et de queue de soupape sont inclus.
	REF	INFERIOR	CONVERSION	PARTIE BASSA	PARTIE BASSE
	FEL17145	Gen V con retén trasero de una pieza y junta cárter de 1 pieza. Junta cárter incluida.	Gen V with one piece rear main bearing seal & one piece oil pan gasket. Oil pan gasket. incl.	Gen V con paraolio posteriore in 1 pz. e guarnizione coppa dell'olio in 1 pz. Include guarnizione coppa.	Gen V avec joint arrière en 2 parties et joint de carter en 4 parties. Joint de carter inclus.
	REC17146	Gen VI con retén trasero de una pieza y junta cárter de 1 pieza. Junta cárter incluida.	Gen VI with one piece rear main bearing seal & one piece oil pan gasket. Oil pan gasket. incl.	Gen VI con paraolio posteriore in 1 pz. e guarnizione coppa dell'olio in gomma in 1 pz. Include guarnizione coppa.	Gen VI avec joint arrière en 1 pièce et joint de carter en 1 pièce. Joint de carter inclus.
	REF	COLECTOR ADMISIÓN-ESCAPE	MANIFOLD INTAKE & EXHAUST	COLLETTORE ASPIRAZIONE-SCARICO	ADMISSION ET ECHAPPEMENT
	REC17341	Gen IV, V y VI sólo H.O. con admisión rectangular. Gene IV, excl. H.O. con admisión rectangular.	Gen IV, V & VI, H.O. only with rectangular intake ports. Gen IV excl. H.O. with rect. intake ports.	Gen IV, V e VI solo H.O. con aspirazione rettangolare. Gen IV escluso H.O. con aspirazione rettangolare.	Gen IV, V et VI uniquement H.O.: avec admission rectangulaire. Gen IV, exc. H.O. avec admission rectangulaire.
	REC17342	JUNTA ADMISIÓN Gen V & VI sólo EFI.	INTAKE GASKET Gen V & VI only EFI.	GUARNIZIONE ASPIRAZIONE Gen V & VI solo EFI.	Joint d'admission Gen V et VI uniquement EFI.
	REC27-46820 3852472	JUNTAS ESCAPE Gen IV, V & VI	EXHAUST GASKET Gen IV, V & VI	GUARNIZIONE SCARICO Gen IV, V & VI	Joints de collecteur d'échappement Gen IV, V et VI.
	REF	CARTER	OIL PAN	COPPA DELL'OLIO	CARTER D'HUILE
	FEL17986 3853510	Gen V & VI 1 pieza, incluye junta de goma.	Gen V & VI 1 piece oil pan gasket. Rubber gasket included.	Gen V & VI 1 pz, guarnizione in gomma inclusa.	Gen V et VI 1 pièce. Comprend joint en caoutchouc.
	REF	RETÉN TRASERO CIGÜEÑAL	Crankshaft rear seal	PARAOLIO POSTERIORE ALBERO MOTORE	JOINT SPI ARRIERE DE VILEBREQVIN
	REC26-14756	Gen IV. Retén Contrarrotación dos pieza.	Gen IV. Reverse rotation oil seal Two- pieces	Gen IV. Controrotante in 2 pz.	Gen IV. Joint spi contre-rotatif en 2 parties.
	REF	TAPA VÁLVULAS	VALVE COVER	COPERCHIO VALVOLE	CACHE CULBUTEUR
	REC17935	Gen IV	Gen IV	Gen IV	Gen IV
	REC17937	Gen V & VI	Gen V & VI	Gen V e VI	Gen V et VI

JUNTAS MOTOR

ENGINE GASKETS

GUARNIZIONE MOTORE

JOINTS MOTEUR

MOTORES GASOLINA  
BASE VOLVO

GAS ENGINE  
VOLVO BASE

MOTORI BENZINA  
BASE VOLVO

MOTEUR ESSENCE  
BASE VOLVO





JUNTAS CULATA

CYLINDER HEAD GASKETS

GUARNIZIONE TESTATA

JOINTS DE CULASSE

REF	OEM		KIT
REC1378645	31378645 463412	AQ120B, 125A, 140A B21 BB140A	REC876300





REF	OEM		GRUESO THICKNESS SPESSORE EPAISSEUR	KIT
REC857621	857621 876783 875543 419628	AQ115A AQ30B, MB20A, B 20 Agujeros redondo Round holes Fori rotondi Trous ronds	2.0 mm	





REF	OEM		KIT
REC1378646	1378646 1326785 1332644	AQ125B AQ131A, B, C, D AQ145A, B AQ151A, B, C AQ171A, C 230A, B 250A, B 251A	REC876301 REC876302 REC876303





REF	OEM		GRUESO THICKNESS SPESSORE EPAISSEUR	KIT
REC9139282	9139282 462623	AQ115B AQ130D MB20, C, B 20 Agujeros ovalados Oval holes Fori ovali Trous ovales	1,2 mm	REC876358



REF	OEM		GRUESO THICKNESS SPESSORE EPAISSEUR
REC419310	419310 419763	AQ115A AQ130A, C, MB20B, B 20 Agujeros ovalados Oval holes Fori ovali Trous ovales	0,8 mm



REF	OEM		GRUESO THICKNESS SPESSORE EPAISSEUR	KIT
REC9139284	913928 3855409 461056 430107 461618	AQ165 AQ170A, B, C, B 30 Agujeros ovalados Oval holes Fori ovali Trous ovales	0,8 mm	REC876337



KIT JUNTAS SUPERIOR

GASKET HEAD SETS

KIT GUARNIZIONI PARTE  
ALTA

POCHETTE HAUTE

REF	OEM		GRUESO THICKNESS SPESSORE EPAISSEUR
REC876356	876356	AQ115A AQ130A, C MB20B Agujeros ovalados Oval holes Fori ovali Trous ovales	0,8 mm

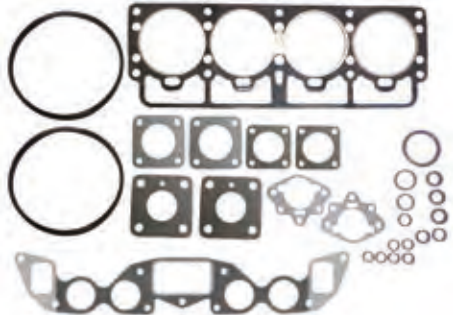

REF	OEM	
REC876337	876337 876335 875402 875533	AQ165A AQ170A, B BB165A BB170A, B





REF	OEM		GRUESO THICKNESS SPESORE EPAISSEUR
REC876358	876358 875569	AQ115B AQ130D MB20C BB115C Agujeros ovalados Oval holes Fori ovali Trous ovales	1,2 mm

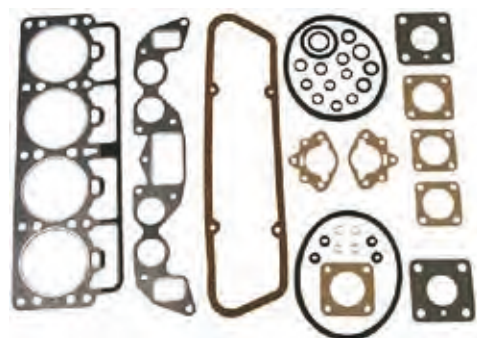

REF	OEM	
REC876300	876300 875587	AQ120B, 125A, 140A BB140A



REF	OEM	
REC876337	876359 875570	AQ170C BB170C

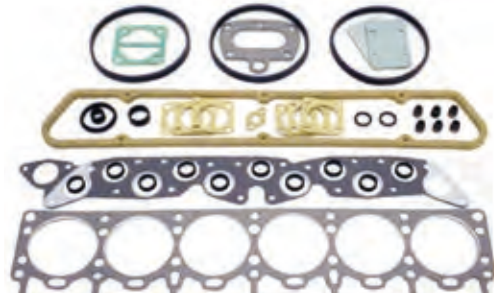

REF	OEM	
REC876302	876302 876022	AQ125B AQ131A, B, C, D AQ145B AQ151A, B, C 230A, B 250A, B



REF	OEM	
REC876301	876301 875678	AQ145A BB145A



REF	OEM	
REC876303	876303 876071	AQ171A, C 251A

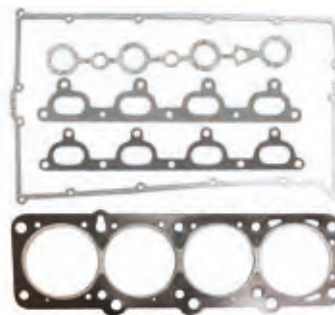

**JUNTAS TAPA DISTRIBUCION**

**TIMING COVER GASKET**

**GUARNIZIONI COPERCHIO DISTRIBUZIONE**

**JOINT CARTER DE DISTRIBUTION**

REF	OEM	
REC1378493	1378493 1276817 463359	AQ/B 230/250/251 120/125/131/140/151/171/145



new

JUNTAS TAPA  
BALANCINES

## VALVE COVER GASKET

REF	OEM	
REC419678	419678	AQ60F, 90, 95, 95A, 110, 120 AQ115A, B AQ130A, B, C, D MB20A, B, C



REF	OEM	
REC430039	430039	AQ165A AQ170A, B, C BB165A BB170A, B, C



REF	OEM	
REC1378909	1378909	AQ120B, 125A, 140, 145A BB140A, 145A

GUARNIZIONI COPERCHIO  
PUNTERIEJOINTS DE CACHE  
CULBUTEUR

REF	OEM	
REC1378870	1378870 1336753	AQ125B AQ131A, B, C, D AQ145B AQ151A, B, C 230A, B 250A, B

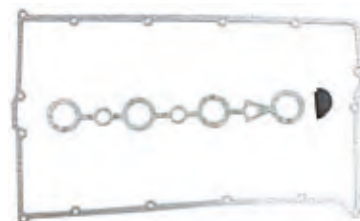

REF	OEM	
REC1378853	1378853	AQ171A, C 251A

JUNTA PORTAREJÉN  
TRASERO CIGÜENALCRANKSHAFT REAR SEAL  
GASKETGUARNIZIONE PARAOLIO  
POSTERIORE ALBERO MOTOREJOINT ARRIERE DE  
VILEBREQUIN

REF	OEM	
REC1378492	1378492 463829	AQ/B 230/250/251 120/125/131/140/151/171/145

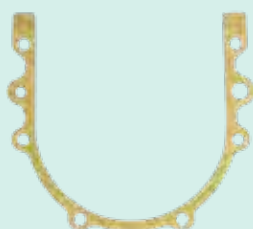

new

## JUNTAS DE ADMISIÓN

## INTAKE GASKET

GUARNIZIONE DI  
ASPIRAZIONE

## JOINTS D'ADMISSION

REF	OEM	
REC1378879	1378879 1266796 463225	AQ120B AQ125A, B AQ131A, B, C, D AQ140A BB140 AQ145A, B AQ151A, B, C 230A 250A



REF	OEM	
REC1378854	1378854	AQ171A, C 251A

JUNTAS DE ADMISIÓN &  
ESCAPEINTAKE & EXHAUST  
GASKETGUARNIZIONE DI  
ASPIRAZIONE E DI SCARICOJOINTS D'ADMISSION &  
D'ÉCHAPPEMENT

REF	OEM	
REC1378913	1378913 461092	AQ165A AQ170A, B, C BB170C





**JUNTAS DE ESCAPE  
BASE VOLVO**

**EXHAUST GASKET  
BASE VOLVO**

**GUARNIZIONE DI  
SCARICO BASE VOLVO**

**JOINTS D'ÉCHAPPEMENT  
BASE VOLVO**



REF	OEM		COLLECTOR MANIFOLD COLETTORE COLLECTEUR
REC856044	856044 824633		AQ115A, B AQ130A, B, C, D BB115A, B, C HGE4532



REF	OEM	
REC855967	855967	



230A, B  
250A, B  
AQ120, 125, 131, 140, 145,151



REF	OEM	
REC855513	855513	

AQ171A,C  
251A



REF	OEM	
REC1378911	1378911 418870	

AQ60F, 90, 95, 95A, 100, 105A, 110, 120  
BB30, 10  
MB18  
MB20A, B, C





**JUNTAS DE CÁRTER**

**OIL PAN GASKET**

**GUARNIZIONE COPPA  
DELL'OLIO**



**JOINTS DE CARTER D'HUILE**

REF	OEM	
REC1378864	1378864 463587 418262	

AQ60F, 90, 95, 95A, 105, 110  
AQ115A, B,  
AQ120, B  
AQ125A, B  
AQ130A, B, C, D  
AQ131A, B, C, D  
AQ140A

AQ145A, B  
AQ151A, B, C  
AQ171A, C  
230A, B  
250A, B  
251A  
MB18  
MB20A, B, C



REF	OEM	
REC1378914	1378914 461113	

AQ165A, B  
AQ170A, B, C  
BB165A  
BB170A, B, C



**KIT JUNTAS INFERIOR**

**CONVERSION GASKET  
SETS**



**KIT GUARNIZIONI PARTE  
BASSA**

**POCHETTE BASSE**

REF	OEM	
REC876342	876342 875400	

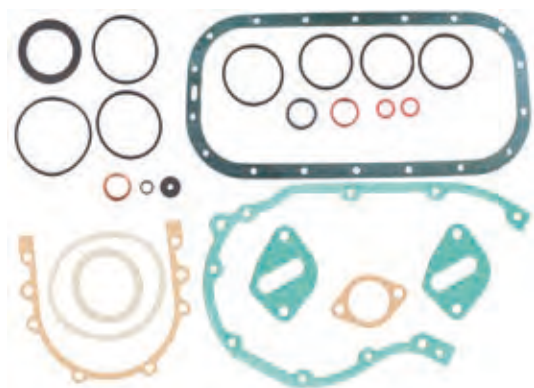
AQ60F, 90, 95, 95A, 105, 110, 120  
AQ115A, B  
AQ130A, B, C, D  
MB20A, B, C  
Incluye juntas para B18, 20  
Includes B18, 20 mod. gaskets  
Include le guarnizione per B18, 20  
Joints pour B18, 20 sont inclus.



REF	OEM	
REC876306	876306 875403	

AQ165A  
AQ170A, B, C  
BB165A  
BB170A, B, C

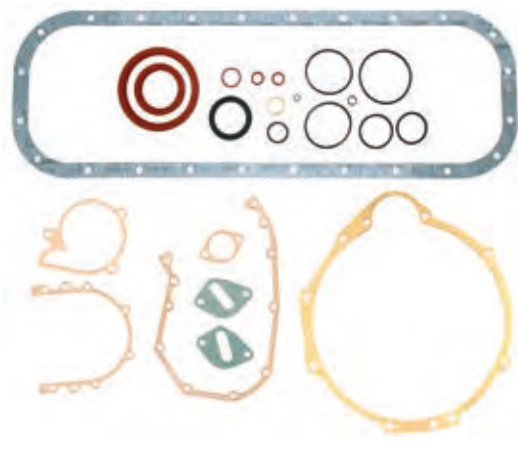



REF	OEM		
REC876393	876393	AQ120B	AQ145A
	876433	AQ125A	BB140A
	875588	AQ140A	BB145A

REF	OEM		
REC876448	876448	AQ125B	
	876023	AQ145B	

REF	OEM		
REC876304	876304 876072	AQ131A, B, C, D	
		AQ151A, B, C	
		171A, C	
		230A, B	
		250A, B	
		251A	

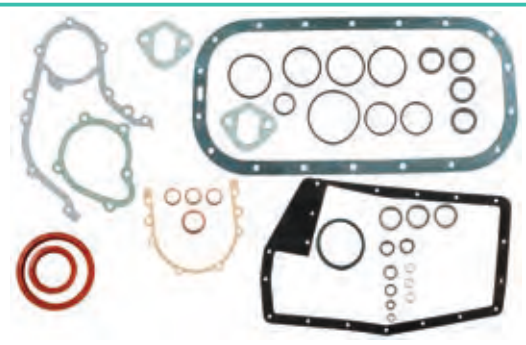

MOTORES DIESEL    DIESEL ENGINE    MOTORI DIESEL    MOTEUR DIESEL



JUNTAS CULATA    CYLINDER HEAD GASKETS    GUARNIZIONE TESTATA    JOINTS DE CULASSE

REF	OEM		KIT	Ø
REC859151	859151 833070	MD1B, 2B, 3B AQD2B	REC876377	89 mm

REF	OEM		KIT
REC859137	859137 833453	MD11C, D	REC876376
		MD17C, D	REC876380

REF	OEM		KIT
REC840569	840569	2001 AG, B, BG	REC876307

new

REF	OEM	
REC861865	861865	MD2010/B/-C/-D

REF	OEM		KIT
REC859134	859134 838127	MD5A, B, C	REC876341

REF	OEM		KIT
REC859094	859094 840328	2002 AG, B, BG, D	REC876308

REF	OEM		Ø
REC833274	833274	D1A, 2A AQD2A MD1, 1A, 2, 2A	79 mm





REF	OEM		GRUESO THICKNESS SPESSORE EPAISSEUR	KIT
REC3809167	3809167 859136 840270 860749	MD 7A, B	MO 35145+	0,8 mm REC876431



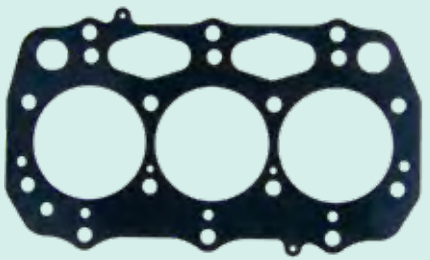

REF	OEM		KIT
REC3580234	3580234	MD2020/B/-C/-D	REC21760





REF	OEM		KIT
REC859135	859135 3875376	MD6A, B	REC876379





REF	OEM		KIT
REC3580309	3580309	MD2030A, B, C, D	REC21760



REF	OEM		GRUESO THICKNESS SPESSORE EPAISSEUR	KIT
REC3809167	859136	MD7A	MO -35144	1,3 mm REC876431





REF	OEM		KIT
REC3584202	3584202 3580482	2040 MD2040A, B, C, D	REC21761





REF	OEM		GRUESO THICKNESS SPESSORE EPAISSEUR
REC3808602	3808602	D1-13, B, F	1,2 mm
REC3809647	3809647		1,3 mm





REF	OEM		GRUESO THICKNESS SPESSORE EPAISSEUR
REC3812109	3812109	D1-20A, B, F	1,2 mm
REC3886431	3886431		1,3 mm





REF	OEM		KIT
REC859093	859093 840405	2003, AG, B, BG, D, T, TB	REC876310





REF	OEM		GRUESO THICKNESS SPESSORE EPAISSEUR
REC3840842	3840842	D1-30A, B, F	1,3 mm
REC3812199	3812199		1,2 mm





REF	OEM		GRUESO THICKNESS SPESORE EPAISSEUR
REC21192973	21192973 3840843	D2-40A, B, F	1,2 mm
REC21192974	21192974 3889517		1,3 mm





REF	OEM		KIT
RM21228429	21228429	D2-55A, B, C, E D2-75A, B, C D2-50F	REC3589322





REF	OEM		KIT
REC859647	859647	MD22A, L-A, L-B, P-B TAMD22P-B TMD22A, B	REC21762 REC21763 REC21764 REC21765





REF	OEM	
REC21165389	21165389 3581868	D4



REF	OEM		KIT
REC3582432	3582432 858993 838628	D31 KAD32 P-A, P	REC3582435





REF	OEM		GRUESO THICKNESS SPESORE EPAISSEUR	A	CLASE CLASS CLASSE CLASSE
REC30731261	30731261	D3-110I-A, I-B, I-C	1.02 mm	1	A
REC30731262	30731262	D3-130A-A, I-A, A-B, I-B, A-C, I-C	1.07 mm	2	B
REC30731263	30731263	D3-160A-A, I-A, A-B, I-B,	1.12 mm	3	C
REC30731264	30731264	A-C, I-C,	1.17 mm	4	D
REC30650525	30650525	D3-190A-B, I-B, A-C, I-C.	1.27 mm	5	E



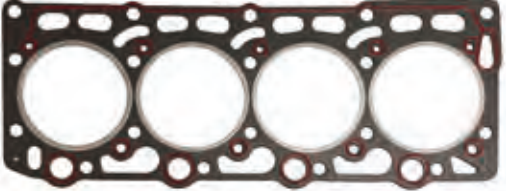

REF	OEM		KIT
REC859150	859150 1544109	AD30A AQAD30A MD30A TAMD30A TD30A TMD30A	REC3582597





REF	OEM		KIT
REC3583786	3583786 3582433 3580742 858992 876853	41 KAD42A KAMD42A D43, 44, 300	REC3583787 REC3583788



REF	OEM		GRUESO THICKNESS SPESORE EPAISSEUR	KIT
REC859152	859152 829531 829214	MD21A, B AQD21A, B	1,6 mm	REC876417



REF	OEM		KIT
REC21165390	21165390 3581869	D6	REC21371111



REF	OEM		KIT
REC859155	859155 858503	40A, B, C	REC3582596

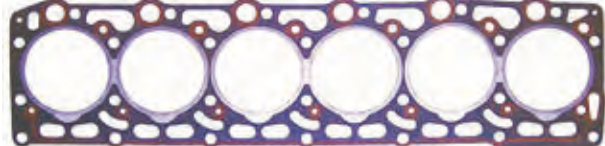



**KIT JUNTAS SUPERIOR**

**GASKET HEAD SETS**

**KIT GUARNIZIONI PARTE ALTA**

**POCHETTE HAUTE**

REF	OEM	
REC876377	876377	
	875500	
	875502	
	875504	
	876374	
876375	MD1B, MD2B (Se necesitan 2 kits   2 kits required   2 kit ne servono   2 sont nécessaires) MD3B (Se necesitan 3 kits   3 kits required   3 kit ne servono   3 sont nécessaires)	

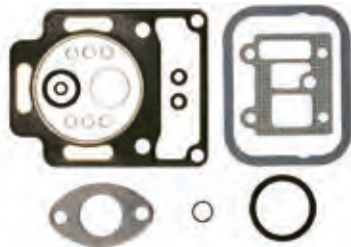

REF	OEM	
REC876380	876380	
	875572	
MD17C, D No incluye kit de gomas: REC875550 Kit seals not included: REC875550 Non include kit dei paraolio: REC875550 Les joints de chemise ne sont pas inclus: REC875550		

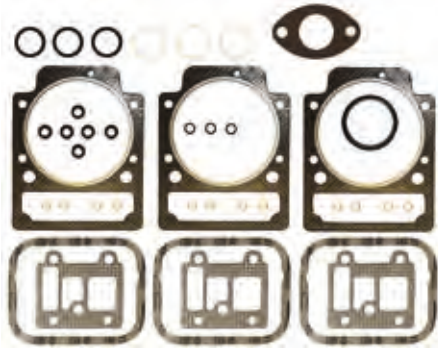

REF	OEM	
REC876341	876341 875561	
MD5A, B, C		



REF	OEM	
REC876379	876379	
	875508	
MD6A, B		

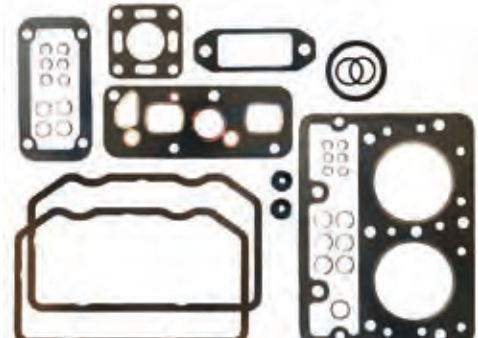

REF	OEM	
REC876307	876307	
2001, AG, B, BG		

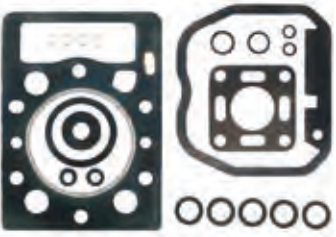

REF	OEM		GRUESO THICKNESS SPESSORE EPAISSEUR
REC876431	876430		1.3 mm
	876431		
MD7A			

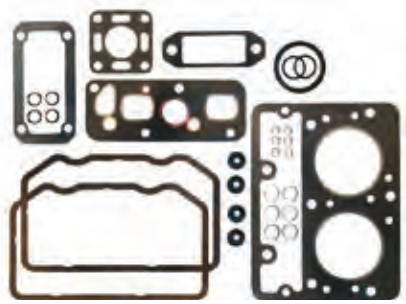

REF	OEM	
REC876308	876308	
2002, AG, B, BG, D		

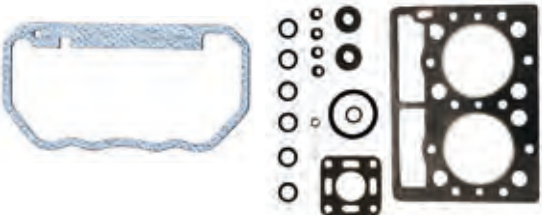

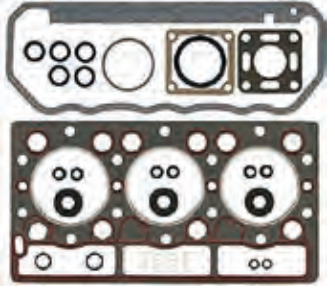

REF	OEM	
REC876310	876310	
2003, D, T, TB, AG, B, BG		



REF	OEM	
REC876376	876376	
	875553	
MD11C, D No incluye kit de gomas: REC875550 Kit seals not included: REC875550 Non include kit dei paraolio: REC875550 Les joints de chemise ne sont pas inclus: REC875550		





REF	OEM	
REC21760	2030A, B, C, D	



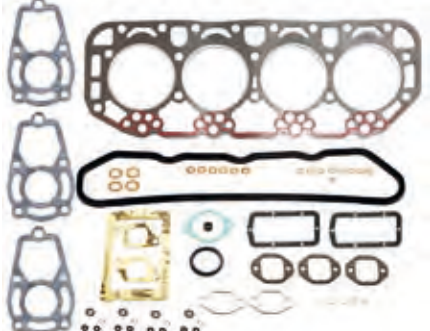

REF	OEM	
REC876417	876417 875388 875567	AQD21A, B MD21A, B



REF	OEM	
REC21761	2040A, B, C, D	



REF	OEM	
REC3582597	3582597 876453 875031	MD30A AD30A TD30A TMD30A AQAD30A TAMD30A



REF	OEM	
REC3589322	3589322	D2-55A, B, C, E D2-75A, B, C D2-50F

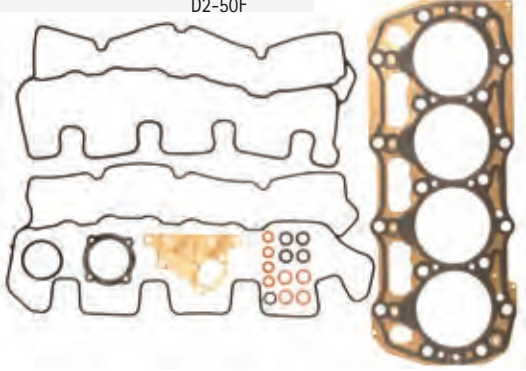

REF	OEM	
REC3582435	3582435 876103 876121 3582434	MD31A, TMD31A, L-A AQAD31A TAMD31A, B, P-A, L-A, M-A AD31B, P-A, L-A KAD32P, P-A

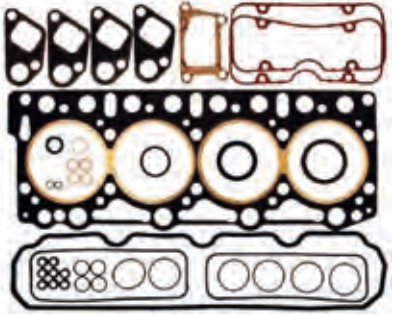

REF	OEM	
REC21371112	21371112 3588432	D4

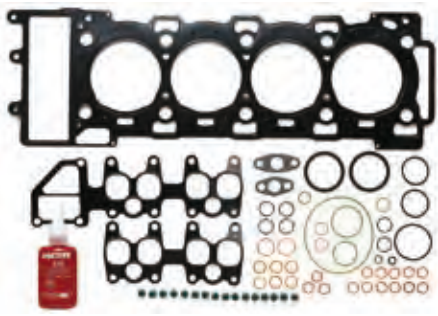



REF	OEM	
REC21762	MD22A, L-A	





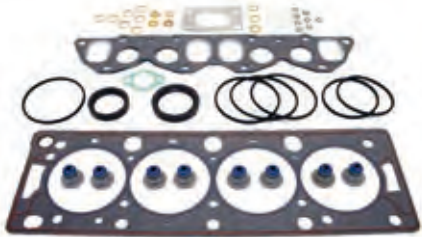

REF		
REC21763	MD22L-B, P-B	



REF		
REC21764	TMD22A	





REF		
REC21765	TAMD22P-B, P-C TMD22B	



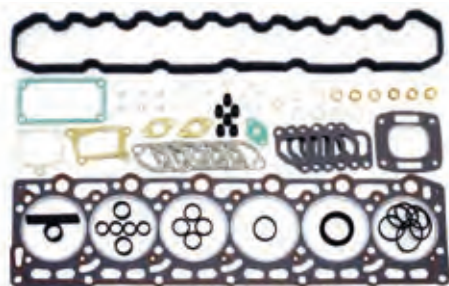

REF	OEM	
REC3582596	3582596	MD40A
	876395	TMD40A, B, C
	875633	AQD40A
	875662	AQAD40A, B
		TAMD40A, B

Junta de turbo no de acero  
 Gasket turbo not steel version  
 Guarnizione turbo non in acciaio.  
 Joint de turbo, pas en acier.



REF	OEM	
REC3583787	AQAD41A	
	AQD41A	
	D41B, L-A	
	KAD42A	
	KAD43P-A	
	KAMD42A	
	KAMD43P-A, P-B	
TAMD41A, B, P-A, L-A, M-A, H-A		
TMD41A, B, L-A		

REF	OEM	
REC876416	876416	AQD32A
	875438	MD32A

REF	OEM	
REC21371111	21371111	D6
	3588433	

REF	OEM	
REC3583788	3583788	D44, 300
	3582437	KAD44P-A, P-B, P-C
		KAMD44P-A, P-C
		KAD300-A
		KAMD300-A

REF	OEM		JUNTA DE CULATA CYLINDER HEAD GASKET GUARNIZIONE TESTATA JOINT DE CULASSE
REC3883845	3883845 3589554	D3-110I-A D3-130A-A, I-A D3-160A-A, I-A	

REF	OEM		JUNTA DE CULATA CYLINDER HEAD GASKET GUARNIZIONE TESTATA JOINT DE CULASSE
REC121154		D3-110I-F, I-G D3-140A-F, A-G, I-F, I-G D3-150I-F, I-G D3-170A-F, A-G, I-F, I-G D3-200A-F, A-G, I-F, I-G D3-220A-F, A-G, I-F, I-G	

REF	OEM		JUNTA DE CULATA CYLINDER HEAD GASKET GUARNIZIONE TESTATA JOINT DE CULASSE
REC121153		D3-110I-D, I-E D3-140A-D, A-E, I-E D3-150I-D, I-E D3-170A-D, A-E, I-D, I-E D3-200A-D, A-E, I-D, I-E D3-220A-D, A-E, I-D, I-E	

REF	OEM		JUNTA DE CULATA CYLINDER HEAD GASKET GUARNIZIONE TESTATA JOINT DE CULASSE
REC121152		D3-110I-B, I-C D3-130A-B, A-C, I-B, I-C D3-160A-B, A-C, I-B, I-C D3-190A-B, A-C, I-B, I-C	

JUNTAS TAPA BALANCINES VALVE COVER GASKET

REF	OEM		
REC859120	859120 802399	MD1A, B MD2A, B MD3B MD11C, D MD17C, D	

REF	OEM		
REC838066	838066	MD5A, B, C	

REF	OEM		
REC840115	840115 3875384	MD6A, B, MD7A (Se necesitan 2 kits   2 kits required   2 kit ne servono   2 sont nécessaires) MD7B (Se necesita 1 kit   1 kit required   1 kit ne servono   1 kit est nécessaire)	

REF	OEM		
REC859042	859042 840572	2001, AG, B, BG	

GUARNIZIONI COPERCHIO PUNTERIE JOINTS DE CACHE CULBUTEUR

REF	OEM		
REC859043	859043 840440	2002 AG, B, BG, D	

REF	OEM		
REC859044	859044 840461	2003 AG, B, BG, D, T, TB	

REF	OEM		
REC30713459	30713459	D3 -B, -C, -D, -E	

REF	OEM	
REC31430317	31430317 30777600	D3,-G,-F

REF	OEM	
REC8642665	8642665	D3-110 --> D3-190
REC8692438	8692438	

REC8692438

REC8642665

REF	OEM	
REC838652	838652	31, 32 AD31A, B, L-A, P-A AQAD31A MD31A

TAMD31A, B  
TAMD31L-A, M-A, P-A  
TMD31A, B, L-A  
KAD32P-A

REF	OEM	
REC3812131	3812131	D1-20, B, F

REF	OEM	
RM1542287	1542287	AD40B AQAD40A, B AQD40A MD40A TAMD40A, B TMD40A, B, C

REF	OEM	
REC3809657	3809657	D1-13, B, F

REF	OEM	
REC838653	838653	D41 KAD42A, B, P-A KAMD42A, B, P-A KAD43P-A

REF	OEM	
REC3884548	3884548	D1-30, B, F

REF	OEM	
REC1544119	1544119	AD30A AQAD30A MD30A TAMD30A TMD30A

REF	OEM	
REC838654	838654	31, 32 (Se necesitan 2 piezas   2 pieces required   2 pz ne servono   2 pièces sont nécessaires) 41, 42, 43 (Se necesitan 3 piezas   3 pieces required   3 pz ne servono   3 pièces sont nécessaires)

KAD42A  
KAMD42A

REF	OEM	
REC889486	889486	D2-55, B, C, D, E, F D2-60F
REC3583546	3583546	D2-55, B, C, D, E, F D2-60F D2-75, B, C, F

JUNTA SUPERIOR | UPPER GASKET | GUARNIZIONE SUPERIORE | JOINT SUPÉRIEUR

JUNTA INFERIOR | DOWN GASKET | GUARNIZIONE INFERIORE | JOINT INFÉRIEUR

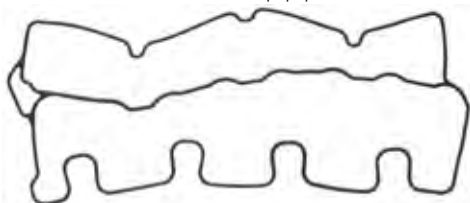

REC889486

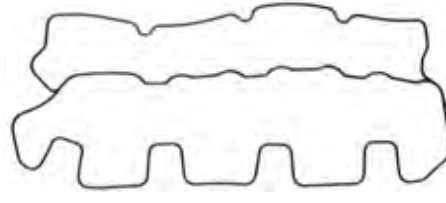

REC3583546



RETENES TAPA  
BALANCINES

## VALVE COVER SEAL

VARILLA NIVEL ACEITE  
OIL DIPSTICK  
ASTICELLA OLIO  
JAUGE D'HUILE

new

REF	OEM		
REC949187	949187	2001, 2002, 2003 D31, 41, 30, 40, 42, 43, 44, 11, 13, 4, 6, 9 MD11, 17, 5, 6, 7 D162, 60, 61, 62, 71, 72, 73, 74, 75 AQ	6.3 x 2.4 mm

REF	OEM	
REC840442	840442	2001 (x1) 2002 (x2) 2003 (x3)

TORNILLO TAPA  
COVER SCREW  
VITE COPERCHIO  
VIS DE COUVERCLE

new

PARAOLIO COPERCHIO  
PUNTERIEJOINT SPI DE CACHE  
CULBUTEUR

REF	OEM		
REC955976	955976 12262 926033 14012262 6647311	2001, 2002, 2003	14.3 x 2.4 mm
REC969198	969198 967643	2001, 2002, 2003 D31, 41, 32, 42, 43, 13	7.3 x 2.1 mm

EJE BALANCÍN  
ROCKET SHAFT  
ASSE BILANCERE  
ARBRE DE CULBUTEUR

new

REF	OEM	
REC471956	471956	

SISTEMA LUBRICACIÓN  
LUBE SYSTEM  
SISTEMA LUBRIFICAZIONE  
SYSTÈME DE LUBRICATION

new

RETÉN TAPA LATERAL  
BLOQUE

## SEAL SIDE COVER BLOCK

GUARNIZIONE COPERCHIO  
LATERALE BLOCCOJOINT DE COUVERCLE  
LATERAL DU BLOC

REF	OEM	
REC1542052	1542052	30, 31, 32, 40, 41, 42, 43, 44, 300

JUNTAS COLECTOR Y CODOS  
DE ESCAPEEXHAUST MANIFOLD  
& ELBOW GASKETGUARNIZIONE COLLETTORE  
E GOMITO DI SCARICOJOINTS COLLECTEUR ET  
COUDES D'ÉCHAPPEMENT

REF	OEM		PIEZAS NECESARIAS REQUIERED PIECE NE SERVONO PEZE PIECES NECESSAIRES
REC3583336	3583336	D4	1
		D6	2



REF	OEM	
REC840902	840902 3875050	MD6A, B MD7A, B 2001, 2002, 2003 AG, B, BG, D, T, TB



REF	OEM		PIEZAS NECESARIAS REQUIERED PIECE NE SERVONO PEZE PIECES NECESSAIRES
REC3582725	3582725	D4, D6	2



REF	OEM	
REC859107	859107	MD1A, B MD2A, B MD3B MD5A, B, C MD6A, B MD7A, B MD11C, D MD17C, D



REF	OEM	
REC859015	859015 803374	MB10A MD1A, B MD2A, B MD3B MD5A, B, C MD6A, B MD7A, B MD11C, D MD17C, D



REF	OEM	
REC859145	859145 833598 897322	MD1A, B MD2A, B MD3B MD11C, D MD17C, D





REF	OEM	
REC30729340	30729340	D3







REF	OEM	
REC859140	859140 819720 819723	MD19, 27, 29, 32A MD21A, B AQD19, 27, 29A, 32A AQD21A, B



REF	OEM		PIEZAS NECESARIAS REQUIRED PIECE NE SERVONO PEZE PIECES NECESSAIRES
REC1542123	1542123 1542177	30 40	4 6



REF	OEM		PIEZAS NECESARIAS REQUIRED PIECE NE SERVONO PEZE PIECES NECESSAIRES
REC876144	876144	31, 32 41, 42, 43, 44, 300	4 6



REF	OEM	
RM859834	859834	MD22A, L-A, L-B, P-B TMD22A, B TAMD22P-B TAMD315-A D2-50F D2-55A, B, C, D, E, F



REF	OEM	
REC840944	840944	2003T

TUBO ADMISION  
INTAKE TUBE  
TUBO ASPIRAZIONE  
TUBE D'ADMISSION

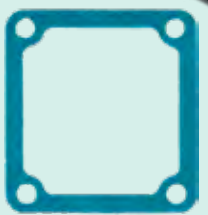

**new**

REF	OEM	
REC861414	861414	D31, D41, MD22

TUBO ESCAPE  
EXHAUST TUBE  
TUBO SCARICO  
TUYAU D'ÉCHAPPEMENT





**new**

REF	OEM	
REC859194	859194 3875382	MD6A, B MD7A, B





REF	
REC22119	MD30A, TMD30A, AQAD30A, T AMD30A

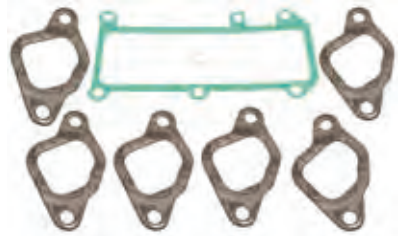

REF	
REC22120	MD40A AQAD40A, B AMD40A, B



REF	
REC22121	AD40B AQAD40A TMD40A, B, C



TÓRICA AMISION  
INTAKE O-RING  
FANCIA TONDA ASPIRAZIONE  
JOINT TORIQUE D'ADMISSION

REF	OEM	
REC967944	967944	D31 D41 D32 D42 D300 D43 D44



**new**

JUNTAS TURBO

TURBO GASKETS

GUARNIZIONI TURBINE

JOINTS DE TURBO

REF	OEM	
RM3588435	3588435	D4, 6



REF	
REC22034	2003T, TB

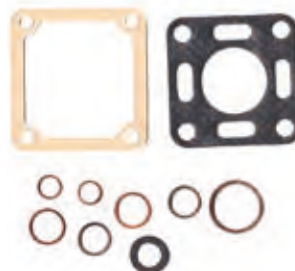

REF	OEM	
REC3582595	3582595 876398	TMD30A TMD40A, B, C TAMD30A TAMD40A, B AQD40A AQAD30A AQAD40A, B AD30A



REF	OEM	
RM3883844	3883844 1275549 + 21584008	D3



**TURBO K26**

REF	OEM	
REC23557470	22557470 3582676 859111 3581570	D31, 41, 30, 40, 32, 300, 42, 43, 44



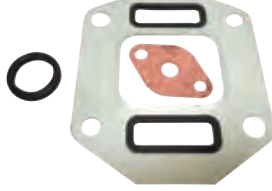

**new**

REF	OEM	
REC22134	MD30A, 31A, 40A	





**CODO AMISION  
INTAKE ELBOW  
GOMITO ASPIRAZIONE  
COUDE D'ADMISSION**

REF	OEM	
REC949841	949841	D4/D6



**new**

REF	OEM	
REC3582563	3582563 876312 876108	AQD41A AQAD31A, 41A TMD31A, B, L-A, TMD41A, B, L-A TAMD31A, B, P-A, L-A, M-A, TAMD41A, B, L-A, M-A, H-A AD31P-A, L-A AD41B, L-A, D31B D41B, L-A D42, 43, 44, 300



**TUBO CARGA DE ACEITE  
OIL INTAKE  
TUBO ASPIRAZIONE OLIO  
TUYAU D'ASPIRATION D'HUILE**

REF	OEM	
REC22206133	22206133 420641 466393	D31, 41, 30, 21, 70, 32, 42, 43, 44 D12, 13, 3, 4, 6, 9 D300, 100, 120, 102, 103, 121, 122, 162, 163, 165, 60, 61, 63, 71, 72, 73, 74



**new**

**TUBO DESCARGA DE ACEITE  
OIL EXHAUST  
TUBO SCARICO OLIO  
TUYAU DE SORTIE D'HUILE**

REF	OEM	
REC20707685	20707685 860105	D31, 41, 32, 42, 43, 44 D11, 13, 3, 4, 6, 8 D300



**new**

**JUNTAS TAPA  
DISTRIBUCION**

**TIMING COVER GASKET**

REF	OEM	
REC859039	859039 1542219	D30, 31, 40, 41, 43, 44, 300 KAD / KAMD 42



**GUARNIZIONE CARTER  
DISTRIBUZIONE**

**JOINTS DE CARTER DE  
DISTRIBUTION**

REF	OEM	
REC859038	859038 842990	D30, 31, 40, 41, 43, 44, 300 KAD / KAMD 42



**JUNTAŞ TAPA TRASERA CIGUENAL**

**REAR CRANKSHAFT COVER GASKET**

**GUAR. CARTER POSTERIORE ALBERO MOTORE**

**JOINTS DE COUVERCLE ARRIERE DE VILEBREQUIN**

REF	OEM	
REC829487	829487	D30, 31, 40, 41, 43, 44, 300 KAD / KAMD 42



**JUNTAS CÁRTER**

**OIL PAN GASKET**

**GUARNIZIONI COPPA DELL'OLIO**

**JOINTS DE CARTER D'HUILE**

REF	OEM	
REC861822	861822	MD2010A, B, C, D D1-13A, B, F

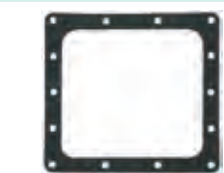

REF	OEM		KIT
REC861251	861251 860685 1542247 859032	40, 41, KAD42A KAMD42A D43, 44, 300	REC876349 REC876774

REF	OEM	
REC21849843	21849843	MD2030A, B, C, D D1-30A, B, F



REF	OEM	
REC3580227	3580227	MD2020A, B, C, D D1-20A, B, F



REF	OEM		KIT
REC861250	861250 860684 1544124	30, 31 KAD32P, P-A	REC876427 REC876361



REF	OEM	
REC3840859	3840859	D2-40A, B, F



REF	OEM		KIT
REC861603	861603 859726	D22 MD22A, L-A, L-B, P-B TAMD22P-B TMD22A, B	REC21766



REF	OEM	
REC840648	840648 818035	MD21A, B MD19 AQD19 AQD21A, B



**KIT JUNTAS INFERIOR**

**CONVERSION GASKET SETS**

**KIT GUARNIZIONI INFERIORI**

**POCHETTE BASSE**

REF	OEM	
REC876378	876378 875501	MD1B

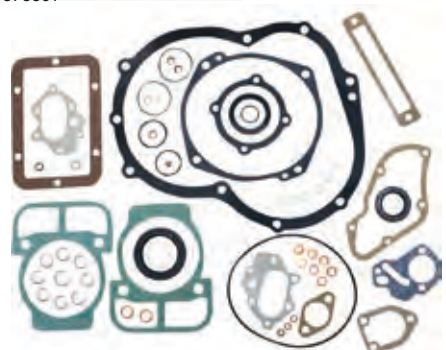

REF	OEM	
REC876388	876388 875505	MD3B



**VOLVO**

**RECAMBIOS MARINOS**



REF	OEM	
REC876389	876389 875503	MD2B AQD2B

REF	OEM	
REC876384	876384 875554	MD11C, D

REF	OEM	
REC876381	876381 875562	MD5A,B

REF	OEM	
REC876383	876383 875573	MD17C, D

REF	OEM	
REC876382	876382 875715	MD5C

REF	OEM	
REC875757	875757	2001, AG, B, BG 2002, AG, B, BG, D 2003, AG, B, BG, D,B

REF	OEM	
REC876314	876314 875509	MD6A, B MD7A, B

REF	OEM	
REC876054	876054	2003T, TB



REF	OEM	
REC877419	877419	D2-55A, B, C, D, E D2-75A, B, C D2-50F

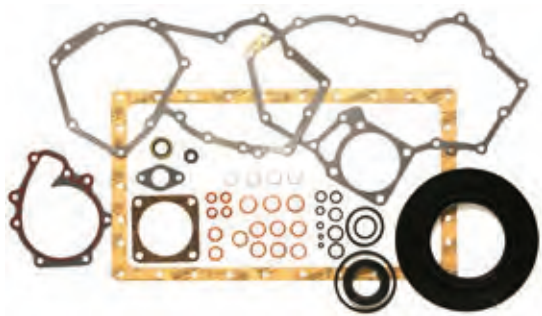



REF	OEM	
REC876427	876427 876032	MD30A AD30A TMD30A AQAD30A TAMD30A





REF	OEM	
REC3588434	3588434	D4, D6





REF	OEM	
REC875387	875387 875421	MD21A, B AQD19 MD19 AQD21A, B



REF	OEM	
REC875439	875439	MD32A AQD32A





REF	OEM	
REC876349	876349 875634	MD40A AD40B TMD40A, B, C AQD40A AQAD40A, B TAMD40A, B

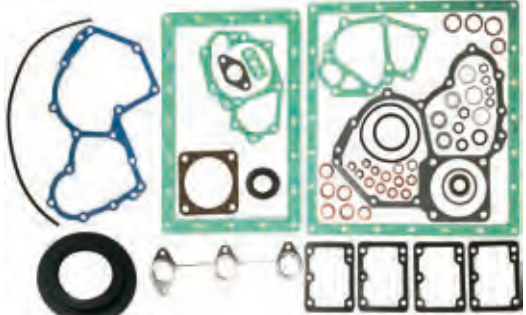

REF	OEM	
REC876655	876655	MD2030A, B, C, D



REF	
REC21766	D22A MD22L-A, L-B, P-B TAMD22P-B TMD22A, B, P-C



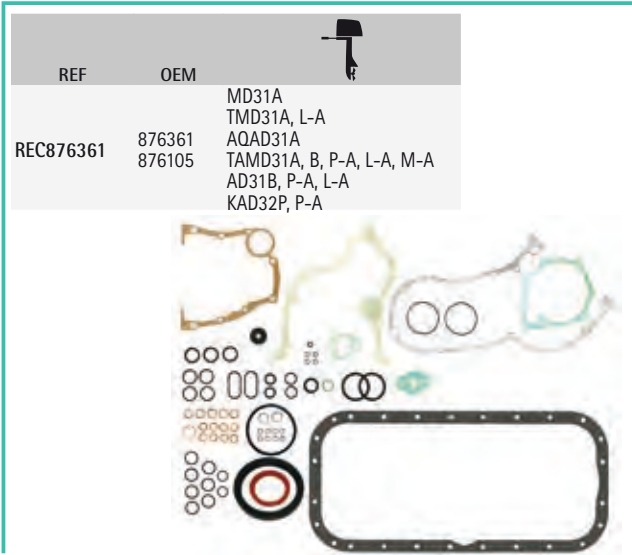
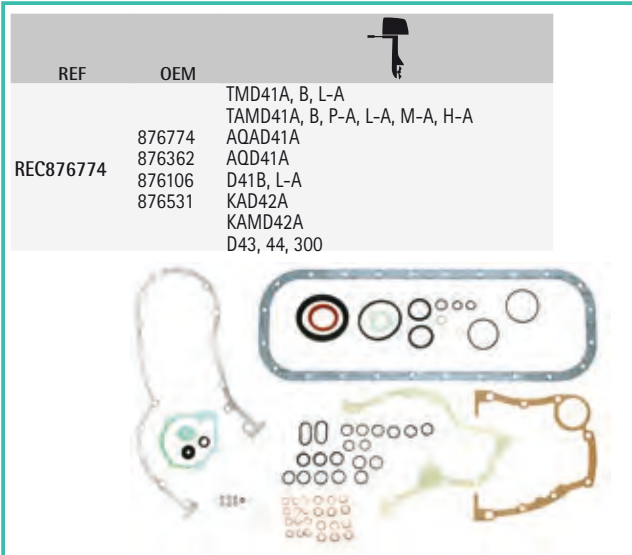



















RETENES CIGÜENAL

CRANKSHAFT SEAL

PARAOLIO ALBERO MOTORE

JOINTS SPI DE VILEBREQUIN

	DELANTERO FRONT SEAL ANTERIORE AVANT	OEM		TRASERO REAR SEAL POSTERIORE ARRIERE	OEM		
AQ120B AQ125A, B AQ131A, B, C, D AQ140A BB140A AQ145A, B BB145A AQ151A, B, C	AQ165A BB165A AQ170A, B, C BB170A, B, C AQ171A, C 230A, B 250A, B 251A	REC1276425	1276425		REC6842160	6842160	
MD1B, 2B AQD2B MD11C, D		REC803356	3588879				
2001, B, AG, BG 2002, B, D, AG, BG 2003, B, D, T, AG, BG, TB, -SOLAS, B-SOLAS, TB-SOLAS		REC6842273	6842273		REC40005775	40005775	
AD30A AQAD30A MD30A TAMD30A TMD30A MD31A AQAD31A AD31A, B, D-A, L-A, P-A, XD TAMD31A, B, D, L-A, M-A, P-A, S-A TMD31A, B, D, L-A KAD32P-A AQAD40A, B AQD40A TMD40A, B, C TAMD40A, B	MD40A AD41A, B, D, L-A, P-A D41A, B, D, L-A AQAD41A TAMD41A, B, D, H-A, H-B, P-A, L-A, M-A TMD41A, B, D, L-A KAD42A, B, P-A KAMD42A, B, P-A TAMD42B, WJ-A KAD43P-A KAMD43P-A KAD44P-A, P-B, P-C KAMD44P-A, P-C KAD300-A KAMD300-A	REC1542318	1542318		REC860971	3582851	
D2-50F D2-55A, B, C, D, E, F D2-60F D2-75A, B, C, F		REC3580586	3580586		REC3583700	3583700	
MD2040A, B, C, D		REC3580586	3580586		REC861823	861823	
D3-110, 130, 140, 150, 160, 170, 190, 200, 220		REC31339213	31339213		REC31339213	31339213	
MD2010A, B, C, D MD2020A, B, C, D MD2030A, B, C, D D1-13A, B, F D1-20A, B, F D1-30A, B D2-40A, B, F		REC3580026	3580026		REC861823	861823	
D4 D6		REC3582748	3582748		REC3586960	3586960	

PISTONES

PISTONS

PISTONI

PISTONS



MOTORES GASOLINA

GAS ENGINE

MOTORI BENZINA

MOTEUR ESSENCE

KITS PISTONES (BASE VOLVO)

PISTONS SETS (VOLVO BASE)

KIT PISTONI (BASE VOLVO)

KITS PISTONS (BASE VOLVO)

REF	OEM			
REC272002	272002	22 mm	STD	AQ115A, B AQ105A AQ130A, B, C, D, AQ165A AQ170A, B, C BB115A, B, C BB165A
REC272004	272004	22 mm	.030	BB170A, B, C MB10A MB20A, B, C



REF	OEM			
REC272059	272059	24 mm	.030	AQ105A AQ115A, B AQ130A, B, C, D, AQ165A AQ170A, B, C BB115A, B, C, BB165A BB170A, B, C MB10A MB20A, B, C,



REF	OEM			
REC272040	272040	1.75 x 2.0 x 4.0 mm	STD	AQ120B AQ125A AQ140A BB140A



KITS AROS DE PISTONES

PISTONS RINGS SET

KIT FASCE PISTONI

KITS SEGMENTS

	REF	OEM		
AQ105, 115, 130, MB 20 (B20), 165A, 170A	REC275334	275334	2.0 x 2.0 x 4.7	STD
	REC275336	275336	2.0 x 2.0 x 4.7	.030
AQ115, 130 (B20), 170B, 170C	REC275344	275344	1.75 x 2.0 x 4.0	STD

	REF	OEM		
AQ120B, 125A, 140A	REC275340	275340	1.75 x 2.0 x 4.0	STD
	REC275341	275341	1.75 x 2.0 x 4.0	0.20



	REF	OEM		
AQ120B, 125A, 140A	REC275337	275337	2.0 x 2.0 x 4.0	STD
	REC275338	275338	2.0 x 2.0 x 4.0	0.50
AQ145A	REC275331	275331	1.75 x 2.0 x 4.0	STD

	REF	OEM		
AQ125B, AQ145B, AQ131A, B, C, D, AQ151A, B, C, AQ171A, C, AQ230A, 250A, 251A	REC275369	275369	1.75 x 1.75 x 3.5 mm	STD
		275370	1.75 x 1.75 x 3.5 mm	0.30

**KITS COJINETES BANCADA**

**MAIN BEARING KITS**

**KIT BRONZINE DI BANCO**

**KITS COUSSINETS DE VILEBREQUIN**



	REF	OEM	
AQ60, 90, 95, 100, 105, 110, 115, 120, 120B, 125A, 130, 140A, 145A, MB18, 20 BB30, 100	REC271214	271214	STD
	REC271215	271215	0.10
	REC271217	271217	STD
AQ165, 170	REC271218	271218	0.10

	REF	OEM	
AQ131C, D 230B, 230A, 250A, 250B, 251A, AQ151C, 171C	REC270906	270906	STD
	REC270907	270907	0.25

**KITS COJINETES BIELA**

**CONNECTING ROD BEARING KITS**

**KIT BRONZINE DI BIELLA**

**KITS COUSSINETS DE BIELLE**



	REF	OEM	
AQ60, 90, 95, 100, 105, 110, 115, 120, 130, MB18, 20, BB30, 100, 27 mm	REC271051	271051	STD
AQ105, 115, 120B, 125A, 130, 140A, 145A, MB20, 24 mm	REC271063	271063	STD
AQ165, 170A, 170B, MO-87712, 27 mm	REC271054	271054	STD

	REF	OEM	
AQ120B, 131, 145B, 151, 171, 230A, 250A, 251A	REC270136	270136	STD
	REC270137	270137	0.25



**KITS COJINETES  
ÁRBOL DE LEVAS****BEARING KIT FOR  
CAMSHAFT****KIT BRONZINE ASSE A  
CAME****KITS COUSSINETS D'  
ARBRE À CAMMES**

REF	OEM	
B21, 23, 25 BB140A, 145A AQ120B, 125A, 125B, 131A, 131B, 131C, 131D 140A, 145A, 145 B, 151A 151B, 151C, 171A, 171C 230A, 230B, 250A, 250B		STD

**MOTORES DIESEL****DIESEL ENGINE****MOTORI DIESEL****MOTEUR DIESEL****KITS PISTONES****PISTONS SETS****KIT PISTONI****KITS PISTONS**

REF	OEM		
REC875551	875551	STD	MD1B, 2B, 3B, AQD2B, MD11C, 11D, 17C, 17D
REC875579	875579	0.75 mm	



REF	OEM		
REC21921545	21921545	STD	D4-180I-B, C, D, E, F D4-210A-A, B D4-210I-A, B D4-225A-B, C, D, E, F D4-225I-B, C, D, E, F D4-260A-A, B, C, D, E, F D4-260D-B, C, D, E, F D4-260I-A, B, C, D, E, F D6-280A-A, B, C, D, E D6-280I-A, B, C, D, E D6-300A-F, F (MC) D6-300I-F D6-310A-A, B, C, D, E D6-310D-B, C D6-310I-A, B, C, D, E D6-330A-B, C, D, E, F D6-330D-B, C, D, E, F D6-330I-B, C, D, E, F D6-350A-A, B D6-370A-B, C, D, E, F D6-370D-B, C, D, E, F D6-370I-A, B, C, D, E, F



REF	OEM		
REC22915955	22915955	STD	D4-300A-A, C, D, E, F D4-300D-A, C, D, E, F D4-300I-A, C, D, E, F D6-400A-E, F D6-435D-A, C, D, E, F D6-435I-A, C, D, E D6-435I-SC-F D6-435I-TC-F D6-435I-WJ-F

**KITS GOMAS CAMISAS****GASKET KITS FOR  
CYLINDER LINER****KIT GOMMINI CAMICIA****KITS JOINTS DE CHEMISE**











REF	OEM		Piezas necesarias pcs required peze necessita Pièces nécessaires
REC875550	875550	MD11C, D MD17C, D	2 3







REF	OEM		Piezas necesarias pcs required peze necessita Pièces nécessaires
REC275751	275751 875651 275595	MD30, 31 MD40, 41, 42, 43, 44, 300 AQAD30A AD31A, B, L-A, P-A, D-A, XD AD41A, B, D, L-A, P-A AQAD31A, 40A, 41A, D41A, B, D, L-A KAD300-A, KAD42A, B, P-A KAD43P-A, KAD44P-A, P-B, P-C KAMD300-A, KAMD42A, B, P-A KAMD43P-A, KAMD44P-A, P-C MD30A, 31A, 40A TAMD30A TAMD31A, B, D, L-A, M-A, P-A, S-A TAMD40A, B TAMD41A, B, D, H-A, H-B, P-A, L-A, M-A TAMD42B, TAMD42WJ-A, TD30A, TD31ACE, TD40A, TMD30A, TMD31A, B, D, L-A, TMD40A, B, C, TMD41A, B, D, L-A	4 6



**KITS CAMISAS  
(PISTON, PIN Y AROS)**
**CYLINDER LINER KITS  
(PISTON, PIN & RINGS)**
**KIT CAMICIA  
(SPINOTTO, PISTONE E FASCE)**
**KITS CHEMISES  
(PISTON, PIN ET SEGMENTS)**

	REF	OEM		REF	OEM		
AQAD30A AQAD40A, B MD30A MD40A TAMD30A TAMD40A, B TD30A TD40A TMD30A TMD40A, B, C	REC875722	875722 275052 875652 875707		AD31L-A, P-A AD41L-A, P-A D41L-A KAD32P-A KAD42P-A KAD43P-A KAMD42P-A KAMD43P-A TAMD31L-A, M-A, TAMD31P-A, S-A TAMD41H-A, H-B, P-A TAMD41L-A, M-A TAMD42WJ-A TMD31L-A TMD41L-A	REC22185027	22185027 3817034 3581714 876851	
AD31A AD41A AQAD31A AQAD41A D41A TAMD31A TAMD41A TMD31A TMD41A	REC876099	876099 867975 838660		KAD44P-A, P-B, P-C KAD300-A KAMD300-A KAMD44P-A, P-C	REC3817861	3817861 3586722	
AD31B, D-A, XD AD41B, D D41B, D TAMD31B, D TAMD41B, D TMD31B, D TMD41B, D	REC22389354	22389354 876834 876819 876784 876261		TAMD72A, P-A, WJ-A TAMD73P-A, WJ-A	REC876548	876548 876611	
KAD42A, B KAMD42A, B TAMD42B	REC22185019	22185019 877071 876527		AQD70B, BL, CL MD70B, BK, C TAMD70B, C THAMD70B, C TMD70B, C	REC875541	875541 875320 875655	
				TD70CHC, CRC TMD70C	REC875676	875676	

**KITS AROS DE PISTONES**
**PISTONS RINGS SET**
**KIT FASCE PISTONI**
**KITS SEGMENTS**

	REF	OEM			REF	OEM	
MD1B, 2B, 3B AQD2B MD11C, D MD17C, D	REC875498	875498	STD	MD TMD22	REC859642	859642	STD
	REC875499	875499	0.30		RM861954	861954	STD
2001, A, B, AG, BG 2002, B, D, AG, BG 2003, B, D, AG, BG, T, TB, -SOLAS	REC876114	876114	STD	MD2010A, B, C, D MD2020A, B, C, D	RM861955	861955	0.50
MD21B AQD21B MD32A	REC876161	876161	STD				



	REF	OEM	
MD2030A, B, C, D	RM3580337	3580337	STD
	RM3580338	3580338	0.50
MD2040A, B, C, D	RM3580546	3580546	STD
	RM3580547	3580547	0.50
D1-13A, B, F D1-20A, B, F	RM3812472	3812472	STD
D1-30A, B, F D2-40A, B, F	RM3812474	3812474	STD
D2-75A, B, C, F	RM21301848	21301848	STD
D2-55A, B, C, D, E, F	RM3583693	3583693	STD
D3-110I-A, I-C, I-B D3-130I-A, I-C, A-A, I-B D3-130I-A-B, A-C D3-160I-A, I-C, A-A, I-B D3-160I-A-B, A-C D3-190I-C, I-B, A-B, A-C D3 (-2003004563)	RM30731740	30731740	STD

	REF	OEM	
D3-110I-G, I-C, I-B, I-D D3-110I-E, I-F D3-130I-C, I-B, A-B, A-C D3-140A-G, I-G, A-D D3-140A-E, A-F D3-150I-G, I-D, I-E, I-F D3-160I-C, I-B, A-B, A-C D3-170A-G, I-G, A-D, A-E D3-170I-D, I-E, A-F, I-F D3-190I-C, I-B, A-B, A-C D3-200A-G, I-G, A-D, A-E D3-200I-D, I-E, A-F, I-F D3-220A-G, I-G, A-D D3-220A-E, I-D, I-E, A-F D3-220I-F D3 (2003004564+)	RM30750678	30750678	STD
D4 D6 SN-A180870 (3,50 mm)	REC22582994	22582994 3586857	STD
D4 D6 SN-A180871+ (3,00 mm)	REC21711728	21711728	STD
TD30A, 31ACE, 40A TAMD30A, 31A, 31B, 40A, 40B, 41A, 41B TMD30A, 31A, 31B, 40A, 40B, 40C, 41A, 41B AQAD30A, 31A, 40A, 40B, 41A MD30A, 31A 40A AD31A, 31B, 41A, 41B D41A, B (2.3 x 2.5 x 4.0 mm) AD31L-A, D-A, P-A, XD AD41D, L-A, P-A D41D, L-A TAMD31D, L-A, M-A, P-A, S-A TAMD41D, H-A, H-B P-A, L-A, M-A TAMD42B, WJ-A TMD31D, L-A TMD41D, L-A KAD32P-A KAD42A, B, P-A KAD43P-A KAMD42A, B, P-A KAMD43P-A (2.8 x 2.5 x 4.0 mm)	REC275350	275350	STD
TAMD41H-A, H-B, P-A, L-A, M-A KAMD44P-A, P-C KAD44P-A, P-B, P-C KAD300-A KAMD300-A (3.3 x 2.5 x 3.0 mm)	REC876775	3586758	STD



KITS COJINETES BANCADA		MAIN BEARING KITS		KIT BRONZE DI BANCO		KITS COUSSINETS DE VILEBREQUIN	
	REF	OEM			REF	OEM	
MD1B, 2B AQD2B MD3B MD11C, D MD17C, D	RM875483	875483	STD	2002, B, C, AG, BG, D	RM875750	875750	STD KIT
	RM875485	875485	0.25				
	RM875773	875773	STD KIT				
2001, B, AG, BG	RM875774	875774	0.25 KIT				

	REF	OEM			REF	OEM			
2003, B, D, T, TB, SG, DG, -SOLAS, B-SO- LAS, TB-SOLAS	RM875751	875751	STD KIT		D2-50F D2-55A, B, C, D, E, F D2-60F D2-75A, B, C, F	RM877387	877387	STD	
	RM875753	875753	0.25 KIT		D4-180I-B, I-C, I-D, I-E, I-F D4-210A-A, I-A, I-B D4-225A-C, A-D, A-E, A-F, I-C, I-D, I-E, I-F, I-B D4-260A-A, A-B, A-C, A-D, A-E, D-B, D-C, D-E, D-D, I-A, I-B, I-C, I-D, I-E, A-F, D-F, I-F D6-280A-A, A-B, A-C, A-D, A-E, I-A, I-B, I-C, I-D, I-E, D, A-E, D-A, D-C, D-E, D-D, I-A, I-C, I-D, I-E, A-F, D-F, I-F D6-300A-F, D-F (MC), I-F D6- 310I-A, A-A, A-B, A-C, A-D, A-E, D-E, I-E, D-B, D-C, D-D, I-B, I-C, I-C D6-330A-B, A-C, A-D, A-E, D-E, I-E, D-B, D-C, D-D, D-F, I-B, I-C, I-D, I-F D6-350A-A, A-B D6-370A-B, A-C, A-D, A-E, D-B, D-C, D-E, D-D, A-F, D-F, I-A, I-B, I-C, I-C, I-EI-F D6-400A-E, A-F D6-435D-A, D-D, D-C, D-E, D-F, I-A, I-C, I-D, I-EI-SC-F, I-WJ-F D9A2A D9-425, 500(R4), 575, D9A-MH D9A2B D9-425, -500(R5), -575, MH D9A2C, D, E, F, G, H, J, K D11B1-A, MP, A-A, A-B, A-C, A-D, A-E, A-D(IPS) D12B2-A MP(IPS)	RM3586871	3586871	STD	
MD21B, A AQD21B, A	REC875306	875306	STD		D6-280A-A, A-B, A-C, A-D, A-E, I-A, I-B, I-C, I-D, I-E, D, A-E, D-A, D-C, D-E, D-D, I-A, I-C, I-D, I-E, A-F, D-F, I-F D6-300A-F, D-F (MC), I-F D6- 310I-A, A-A, A-B, A-C, A-D, A-E, D-E, I-E, D-B, D-C, D-D, I-B, I-C, I-C D6-330A-B, A-C, A-D, A-E, D-E, I-E, D-B, D-C, D-D, D-F, I-B, I-C, I-D, I-F D6-350A-A, A-B D6-370A-B, A-C, A-D, A-E, D-B, D-C, D-E, D-D, A-F, D-F, I-A, I-B, I-C, I-C, I-EI-F D6-400A-E, A-F D6-435D-A, D-D, D-C, D-E, D-F, I-A, I-C, I-D, I-EI-SC-F, I-WJ-F D9A2A D9-425, 500(R4), 575, D9A-MH D9A2B D9-425, -500(R5), -575, MH D9A2C, D, E, F, G, H, J, K D11B1-A, MP, A-A, A-B, A-C, A-D, A-E, A-D(IPS) D12B2-A MP(IPS)	RM3586877	3586877	STD (*)	
	REC875307	875307	0.30		D6-330A-B, A-C, A-D, A-E, D-E, I-E, D-B, D-C, D-D, D-F, I-B, I-C, I-D, I-F D6-350A-A, A-B D6-370A-B, A-C, A-D, A-E, D-B, D-C, D-E, D-D, A-F, D-F, I-A, I-B, I-C, I-C, I-EI-F D6-400A-E, A-F D6-435D-A, D-D, D-C, D-E, D-F, I-A, I-C, I-D, I-EI-SC-F, I-WJ-F D9A2A D9-425, 500(R4), 575, D9A-MH D9A2B D9-425, -500(R5), -575, MH D9A2C, D, E, F, G, H, J, K D11B1-A, MP, A-A, A-B, A-C, A-D, A-E, A-D(IPS) D12B2-A MP(IPS)	RM3586873	3586873	0.25	
AQD29, 29A MD29, 29A MD32A AQD32A	REC875334	875334	STD		D6-400A-E, A-F D6-435D-A, D-D, D-C, D-E, D-F, I-A, I-C, I-D, I-EI-SC-F, I-WJ-F D9A2A D9-425, 500(R4), 575, D9A-MH D9A2B D9-425, -500(R5), -575, MH D9A2C, D, E, F, G, H, J, K D11B1-A, MP, A-A, A-B, A-C, A-D, A-E, A-D(IPS) D12B2-A MP(IPS)	RM20867178	20867178	STD	
MD22L-A, L-B, P-B, A TMDA, -B TMD22P-C, P-B	REC859791	859791	STD		D6-400A-E, A-F D6-435D-A, D-D, D-C, D-E, D-F, I-A, I-C, I-D, I-EI-SC-F, I-WJ-F D9A2A D9-425, 500(R4), 575, D9A-MH D9A2B D9-425, -500(R5), -575, MH D9A2C, D, E, F, G, H, J, K D11B1-A, MP, A-A, A-B, A-C, A-D, A-E, A-D(IPS) D12B2-A MP(IPS)	RM20867751	20867751	0.25	
	REC859945	859945	0.30		D6-400A-E, A-F D6-435D-A, D-D, D-C, D-E, D-F, I-A, I-C, I-D, I-EI-SC-F, I-WJ-F D9A2A D9-425, 500(R4), 575, D9A-MH D9A2B D9-425, -500(R5), -575, MH D9A2C, D, E, F, G, H, J, K D11B1-A, MP, A-A, A-B, A-C, A-D, A-E, A-D(IPS) D12B2-A MP(IPS)	RM20867751	20867751	0.25	
D1-13A, B, F 1 x RM21319767 + 1 x RM3884517	RM21319767	21319767	STD		D6-400A-E, A-F D6-435D-A, D-D, D-C, D-E, D-F, I-A, I-C, I-D, I-EI-SC-F, I-WJ-F D9A2A D9-425, 500(R4), 575, D9A-MH D9A2B D9-425, -500(R5), -575, MH D9A2C, D, E, F, G, H, J, K D11B1-A, MP, A-A, A-B, A-C, A-D, A-E, A-D(IPS) D12B2-A MP(IPS)	RM876657	876657	STD	
D1-20A, B, F 1 x RM21319767 + 2 x RM3884517	RM3884517	3884517	STD		D6-400A-E, A-F D6-435D-A, D-D, D-C, D-E, D-F, I-A, I-C, I-D, I-EI-SC-F, I-WJ-F D9A2A D9-425, 500(R4), 575, D9A-MH D9A2B D9-425, -500(R5), -575, MH D9A2C, D, E, F, G, H, J, K D11B1-A, MP, A-A, A-B, A-C, A-D, A-E, A-D(IPS) D12B2-A MP(IPS)	RM876658	876658	0.25	
D1-30A, B, F	RM21132989	21132989 3884512	STD		D6-400A-E, A-F D6-435D-A, D-D, D-C, D-E, D-F, I-A, I-C, I-D, I-EI-SC-F, I-WJ-F D9A2A D9-425, 500(R4), 575, D9A-MH D9A2B D9-425, -500(R5), -575, MH D9A2C, D, E, F, G, H, J, K D11B1-A, MP, A-A, A-B, A-C, A-D, A-E, A-D(IPS) D12B2-A MP(IPS)	RM876666	876666	STD	
	RM21226191	21226191 3884515	STD		D6-400A-E, A-F D6-435D-A, D-D, D-C, D-E, D-F, I-A, I-C, I-D, I-EI-SC-F, I-WJ-F D9A2A D9-425, 500(R4), 575, D9A-MH D9A2B D9-425, -500(R5), -575, MH D9A2C, D, E, F, G, H, J, K D11B1-A, MP, A-A, A-B, A-C, A-D, A-E, A-D(IPS) D12B2-A MP(IPS)	RM876667	876667	0.25	
D2-40A, B, F	RM21226191	21226191 3884515	STD		D6-400A-E, A-F D6-435D-A, D-D, D-C, D-E, D-F, I-A, I-C, I-D, I-EI-SC-F, I-WJ-F D9A2A D9-425, 500(R4), 575, D9A-MH D9A2B D9-425, -500(R5), -575, MH D9A2C, D, E, F, G, H, J, K D11B1-A, MP, A-A, A-B, A-C, A-D, A-E, A-D(IPS) D12B2-A MP(IPS)	RM876667	876667	0.25	

(\*) central | central | centro | central



	REF	OEM	
MD2030A, B, C, D	RM876660	876660	STD
	RM876661	876661	0.25
MD2040A, B, C, D	RM876663	876663	STD
	RM876664	876664	0.25



	REF	OEM	
AQAD30A MD30A TAMD30A	REC876515	876515	STD
KAD32P-A AQD40A AQAD40A, B MD40A TMD40A, B, C TAMD40A, B AQAD41A D41A, B, D AD41A, B, D, L-A, P-A TMD41A, B, D, L-A TAMD41A, B, D, H-A, H-B, P-A, L-A, M-A KAMD42A, B, P-A KAD42A, B, P-A TAMD42B, WJ-A KAMD43P-A KAD43P-A KAMD44P-A, P-C KAD44P-A, P-B, P-C KAD300-A KAMD300-A	REC876516	876516	0.25
KAD300-A KAMD300-A	REC876519	876519	STD (*)
KAD300-A KAMD300-A	REC876520	876520	0.25 (*)



(\*) central | central | centro | central



**KITS COJINETES BIELA**      **CONNECTING ROD BEARING KITS**      **KIT BRONZINE DI BIELLA**      **KITS COUSSINETS DE BIELLE**

	REF	OEM	
MD1B, 2B, 3B AQD2B MD11C, D MD17C, D	RM875491	875491	STD
	RM875492	875492	0.25
2001, B, AG, BG 2002, B, D, AG, BG 2003, B, D, T, TB, -SOLAS	RM875747	875747	STD
	RM875748	875748	0.25
D1-13A, B, F	RM3884561	3884561	STD
D1-20A, B, F	RM3884557	3884557	STD
MD21A, B AQD21A, B	REC818184	818184	STD
	REC875303	875303	0.30



	REF	OEM	
MD29, A AQD29, A MD32A AQD32A	REC818184	818184	STD
MD22A, L-A, L-B, P-B TMD22A, B, P-C TAMD22P-B	REC875331	875331	0.30
D1-30A, B, F	REC859807	859807	STD
D2-40A, B, F	REC859949	859949	0.30
D1-30A, B, F	RM21252967	21252967	STD
D2-40A, B, F	RM21132990	21132990	STD



	REF	OEM			REF	OEM			
D2-50F D2-55A, B, C, D, E, F D2-60F D2-75A, B, C, F	RM877388	877388	STD		MD2010A, B, C, D	RM876669	876669	STD	
D3-110I-A, I-B, I-D, I-E, I-F, I-G, I-H, I-C D3-130A-A, A-B, A-C, I-A, I-B, I-C D3-140A-D, A-E, A-F, A-G, A-H, I-G, I-H D3-150I-D, I-E, I-F, I-G I-H D3-160A-A, A-B, A-C, I-A, I-B, I-C D3-170A-D, A-E, A-F, A-G, A-H, I-D, I-E, I-F, I-G, I-H D3- 190A-B, A-C, I-B, I-C D3-200A-D, A-E, A-F, A-G, A-H, I-D, I-E, I-F, I-G, I-H D3-220A-D, A-E, A-F, A-G, A-H, I-D, I-E, I-F, I-G, I-H D4-180I-B, I-C, I-D, I-E, I-F D4-225A-E, A-D, A-F, I-C, I-B, I-D, I-E, I-F D4-210A-A, I-A, I-B D4-260A-A, A-B, A-C, A-D, A-E, A-F, D-B, D-C, D-D, D-E, D-F, I-A, I-B, I-C, I-D, I-E, I-F D4-300A-A, A-C, A-D, A-E, A-F, D-A, D-C, D-E, D-D, D-F, DF(MC), I-D, I-E, I-F D6-280A-A, A-B, A-C, A-D, A-E, I-A, I-B, I-C, I-D, I-E D6-310A-A, A-B, A-C, A-D, A-E, D-B, D-C, D-E, D-D, I-A, I-B, I-C, I-D, I-E D6-330A-B, A-C, A-D, A-E, A-F, D-B, D-C, D-D, D-E, D-F, I-B, I-C, I-D, I-E, I-F D6-350A-A, A-B D6-370A-B, A-C, A-D, A-E, A-F, D-B, D-C, D-D, D-E, D-F, I-A, I-B, I-C, I-D, I-E, I-F D6-400A-E, A-F D6- 435D-A, D-C, D-D, D-E, D-F, I-A, I-C, I-D, I-E, I-SC-F, I-WJ-F	RM9180722	31251996	STD		MD2020A, B, C, D	RM876670	876670	0.25	
D9-425 D9-500(R4) D9-575, D9-A-MH, MG D9-425, MH D9-500(R5), 575, MH D9A2, A, B, C, D, E, F, G, H, J, K	RM3586883	3885323	STD		MD2030A, B, C, D	RM876682	876682	STD	
D11-A MP D11B2-A MP(IPS) D11A-A, A-B, A-C, A-C(IPS), A-D, -A-D(IPS), A-E	RM3885324	3885324	0.25		MD2040A, B, C, D	RM876683	876683	0.25	
	RM20867177	20867177	STD		AQAD30A MD30A TAMD30A TMD30A AD31A, B, D-A, L-A, P-A, XD AQAD31A TAMD31A, D, B, L-A, M-A, P-A, S-A TMD31A, D, B, L-A MD31A KAD32P-A MD40A TMD40A, B, C TAMD40A, B AQAD40A, B AQD40A AD41A, B, D, L-A, P-A D41A, B, D, L-A AQAD41A TMD41A, B, D, L-A TAMD41A, B, D, H-A, H-B, P-A, L-A, M-A KAMD42A, B, P-A KAD42A, B, P-A TAMD42B, WJ-A KAM- D43P-A KAD43P-A KAMD44P-A, P-C KAD44P-A, P-B, P-C KAD300-A KAMD300-A	REC876511	876511	STD	
	RM20867661	20867661	0.25			RM876685	876685	STD	
	RM20856959	20856959	STD			RM876686	876686	0.25	
						RM876512	876512	0.25	

RETENES BOMBA DE ACEITE

OIL PUMP SEAL

PARAOILIO POMPA L'OLIO

JOINTS DE POMPE A HUILE

REF	OEM		
REC469482	469482	D30, 31 D40, 41 D70 D32 D42, 43, 44 D13 D300	 new

REF	OEM		
REC976039	976039 980936 1542385 859055	D30, 31 D41 D11, 12, 16, 4, 6, 9 D32 D42, 43, 44 D13 D300	 new

VÁLVULAS

VALVE

VALVOLA

SOUPAPE



RETENES		VALVE STEM SEALS		PARAOLIO VALVOLE		JOINTS DE QUEUE DE SOUPAPE	
REF	OEM	RETEN SEAL PARAOLIO D'HUILE		ARO O-RING ANELLO TORIQUE		REF	OEM
		REF	OEM	REF	OEM		
AQ120B AQ125A, B AQ131A, B, C, D AQ140A AQ145A, B AQ151A, B, C AQ165A AQ170A, B, C	BB140A BB145A BB165A BB170A, B, C 230A, B 250A, B	REC1306630	1306630	REC3514432	3514432	REC1306630	REC3517893
AQ171A, C, 251A		REC3517893	3517860				
3.0GLP-A, -B, -C, -D, -E, -J, -N, 3.0GLM, MDA-A, -B-C 3.0GSP, MDA, -A, -B, -C 3.0HUB, NCA, NCS 3.0GSM-A, -B, -C 3.0HUB, NCA, NCS 3.0GXIC-J 4.3GLMMDA, GSPMDA, GLPHUB, NCA, GSPHUB, HUS, GIPHUSCE, NCACE, NCMCE, CSJNCS, NCM 5.7GLPMDA, GIPMDA, GIPHUS, NCACE, NCMCECE, GLIMDA, GIIMDA, NCSCE 740B 7.4GLPMDA, NCA, NCM, M, HUS, GLIMDA, M, HUB, GLPNCS, B, GIPHUSCE, GIIHUBCE, NCCCE, PNCBCE 8.2GLPMDA, M, GLIMDA, M				REC26-34217	3854956	REC70817B	REC3514432
4.3GLMMDA, GLPMDA, GSPMDA, GSPMDA, GLPHUB, GSPHUB, GSPHUS, GIPHUSCE, GLPNCA, GSJNCS, GSPNCA, GSPNCM, GIPNCACE, GIPNCMCE, GLPLKD, GLPLKE, GSPKLD, GSPLKE, GIPLKCE, GIPLKECE, GSJLKD 5.7GLPMDA, GIPMDA, GIPMDACE, GLIMDA, GIIMDA, GIPHUS, GIPNCACE, GIPNCMCE, GIINCSCCE, GLPK, GSPK, GLIPL		REC26-75988	3853521			REC26-75988	REC26-34217
AQ120B, 125, 131, 140, 145, 151, 230A, 250A		REC3514432	3514432				
V6 & V8 VORTEC		REC26-8M0150312	3862362 3857648			REC26-8M0150312	



RETENES		VALVE STEM SEALS		PARAOLIO VALVOLE		JOINTS DE QUEUE DE SOUPAPE	
REF	OEM	REF	OEM	REF	OEM	REF	OEM
2001, B, AG, BG 2002, B, D, AG, BG 2003, B, D, AG, BG, T, TB, -SOLAS, B-SOLAS, TB-SOLAS AD31A, B, D-A, L-A, P-A, XD AQAD31A MD31A TMD31A, B, D TAMD31A, B, D, L-A, M-A, P-A, S-A TMD31L-A KAD32P-A AD41A, B, D, L-A, P-A D41A, B, D, L-A AQAD41A TMD41A, B, D, L-A TAMD41A, B, D, H-A, H-B, P-A, L-A, M-A KAD42A, B, P-A MD2030A, B, C, D MD2040A, B, C, D D1-30, B, F D2-40, B, F	KAMD42A, B, P-A TAMD42B, WJ-A KAD43P-A KAMD43P-A TAMD63L-A, P-A TAMD74A-A, A-B, C-A, C-B, L-A, L-B, P-A, P-B TAMD75P-A D9A2A D9-425, -500(R4), -575-MH, -MG D9A2B D9-425, -500(R5), -575-MH D9A2E D9-425 D9A2F D9-575 D9A2C, D, E, F, G, H, J, K D12D-A MH, -A MG, -A MP, -B MH, -C MH, -G MH, -A MP, -B MP, -C MP, -D MP, -E MP, -E MG, -F MP, -G MP, -H MP, -E MH, D12C-A MP (NEW STYLE)			REC859171	21501189	REC859171	
MD2010A, B, C, D MD2020A, B, C, D	D1-13, B, F D1-20, B, F			REC22393048	22393048 3580305 3580306		
D3, 4, 6 KAD44 KAMD44	KAD300 KAMD300			REC861860	861860		
				REC861700	861700 877072 877073		

# SISTEMA DE ESCAPE Y ADMISIÓN EXHAUST & INTAKE SYSTEM

# SISTEMA DI SCARICO E ASPIRAZIONE SYSTEME D'ÉCHAPPEMENT ET D'ADMISSION

## COMPONENTES DE FIJACION

## FIXING COMPONENTS

## COMPONENTI DI FISSAGGIO

## COMPOSANTS DE FIXATION

### KIT TORNILLOS COLECTOR

### EXHAUST MANIFOLD, BOLTS

### VITI COLLETTORE SCARICO

### VIS DE COLLECTEUR D'ÉCHAPPEMENT

REF	OEM		
REC1306341	1306341	AQ120B, 125, 131, 140, 145, 151 230, 250 BB140A, 145A	X 10



REF	OEM		
REC838775	838775 1542144 1542019	D30, D31, D 32, D41, D40, D42, D43, D44, D300	



new

REF	OEM		
REC1317761	1326239 1317761	X 3 X 7	AQ171, 251



### TAPÓN ÁRBOL DE LEVAS

### RUBBER WASHER FOR CAMSHAFT

### TAPPO ASSE A CAME

### BOUCHON ARBRE À CAMES

REF	OEM		
REC1336763	1336763	AQ 125, 145B, 151, 230, 250	



### TUERCA DE CULATA CON JUNTA

### CYLINDER HEAD NUT WITH GASKET

### DADO TESTATA CON GUARNIZIONE

### ÉCROU DE CULASSE AVEC JOINT

REF	OEM		
REC994130	1306341 994130	MD1B MB2B, 11C, D MB3B, 17C, D	X 3 X6 x8



### TAPÓN BLOQUE

### EXPANSION PLUG

### TAPPO BLOCCO MOTORE

### PASTILLE DE SABLAGE BLOC MOTEUR

	Ø	REF	OEM
AQ 131, 140B, 145, 151, 230, 250, 251	35	REC463903	463903
	40	REC968955	968955
	42	REC463902	463902
	45	REC192212	463904
AQ 175A, 205A, 430A,B, 431A,B V8	52	REC463905	463905
	26	REC477026	477026
	35	REC477024	477024
B18, 20 V-8 MD5, 6, 7 2001, 2002, 2003 D30, 31, 32, 40, 41, 42, 43, 44, 60, 63, 70, 71, 73, 74, 75, 300	26	REC477026	477026 192426



	Ø	REF	OEM	
B18, 25 V-8 MD1, 2, 3, 6, 7, 11, 17 2001, 2002, 2003 D60, 63, 70, 71, 73, 72 B23, 25 V-8	35	REC477024	477024 192211 463903	
	D9, 11, 13, 16, 30, 31, 32, 40, 41, 42, 43, 44, 63, 71, 72, 73, 74, 300	40	REC968955	968955 1542263
		42	REC463902	463902 955103 192212 463904
	B18, 20, 30 D21 B21, 23, 25, 30 D30, 31, 32, 40, 41, 42, 43, 44, 300	45	REC192212	192212 463904
	52	REC463905	463905	





GUÍA DE COMPONENTES DE MOTOR

ENGINE COMPONENTS GUIDE

GUIDA AI COMPONENTI DEL MOTORE

GUIDE DES COMPOSANTS DU MOTEUR

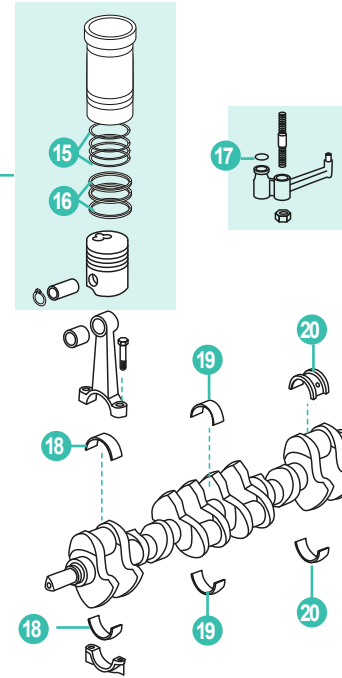
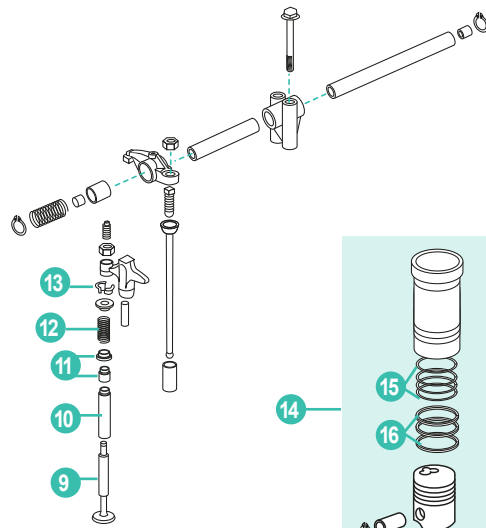
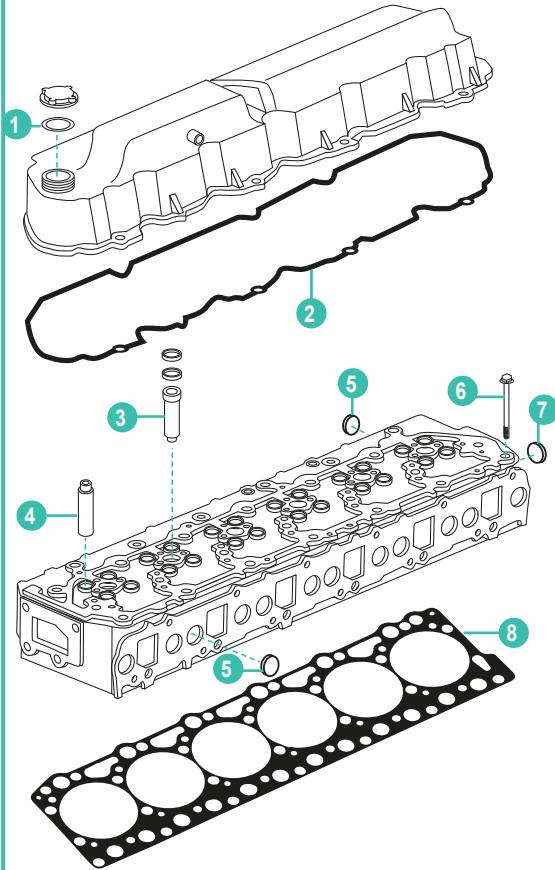

	D30	D31	D32	D40	D41	D42	D43	D44	KAD300	
1	REC1275379	REC1275379	REC1275379	REC1275379	REC1275379	REC1275379	REC1275379	REC1275379	REC1275379	
2	REC1544119	REC838652	REC838652	RM1542287	REC838653	REC838653	REC838653			
3		REC861255			REC861255	REC861255	REC861255	REC861688	REC861688	
		REC3581536	REC3581536		REC3581536	REC3581536	REC3581536			
4	REC3582561	REC3582561	REC3582561	REC3582561	REC3582561	REC3582561	REC3582561			
5	REC477026	REC477026	REC477026	REC477026	REC477026	REC477026	REC477026	REC477026	REC477026	26 mm
6	REC838775	REC838775	REC838775	REC838775	REC838775	REC838775	REC838775	REC838775	REC838775	
7		REC968955	REC968955		REC968955	REC968955	REC968955	REC968955	REC968955	
8	REC859150	REC3582432	REC3582432	REC859155	REC3583786	REC3583786	REC3583786	REC3583786	REC3583786	
9	REC1542472	REC838637	REC838637	REC1542472	REC838637	REC838637	REC838637	REC861698	REC861698	ADMISIÓN INTAKE ASPIRAZIONE ADMISSION
	REC1542389	REC838638	REC838638	REC1542389	REC838638	REC838638	REC838638	REC861699	REC861699	ESCAPE EXHAUST SCARICO ECHAPPEMENT
10	REC3582561	REC3582561	REC3582561	REC3582561	REC3582561	REC3582561				
11	REC859171	REC859171	REC859171	REC1306630	REC859171	REC859171	REC859171	REC861700	REC861700	
12	REC1545198	REC1545198	REC1545198	REC1545198	REC1545198	REC1545198	REC1545198			
13	REC419643			REC419643						
14	REC875722	REC876099	REC22185027	REC875722	REC876099	REC22185019	REC3817861	REC3817861	REC3817861	
		REC22389354			REC22389354	REC22185027	REC22185027			
		REC22185027			REC22185027					
15	REC275751	REC275751	REC275751	REC275751	REC275751	REC275751	REC275751	REC275751	REC275751	
16	REC275350	REC275350		REC275350	REC275350	REC876775	REC876775	REC876775	REC876775	
		REC3817033	REC3817033		REC3817033	REC3817033	REC3817033			
17	REC955981	REC955981	REC955981	REC955981	REC955981	REC955981	REC955981	REC955981	REC955981	
18	REC876511	REC876511	REC876511	REC876511	REC876511	REC876511	REC876511	REC876511	REC876511	STD
	RM876512	RM876512	RM876512	RM876512	RM876512	RM876512	RM876512	RM876512	RM876512	025
19	REC876515	REC876515	REC876515	REC876515	REC876515	REC876515	REC876515	REC876515	REC876515	STD
	REC876516	REC876516	REC876516	REC876516	REC876516	REC876516	REC876516	REC876516	REC876516	025
20		REC876519	REC876519		REC876519	REC876519	REC876519	REC876519	REC876519	STD
		REC876520	REC876520		REC876520	REC876520	REC876520	REC876520	REC876520	025

DESPIECES COLECTORES Y CODOS

MANIFOLDS & ELBOWS PARTS

PARTI COLLETTORI E GOMITI

PARTIES COLLECTEURS ET COUDES

AQ115A, B • BB115A, B, C • AQ130A, B, C, D



REF  
REC22005

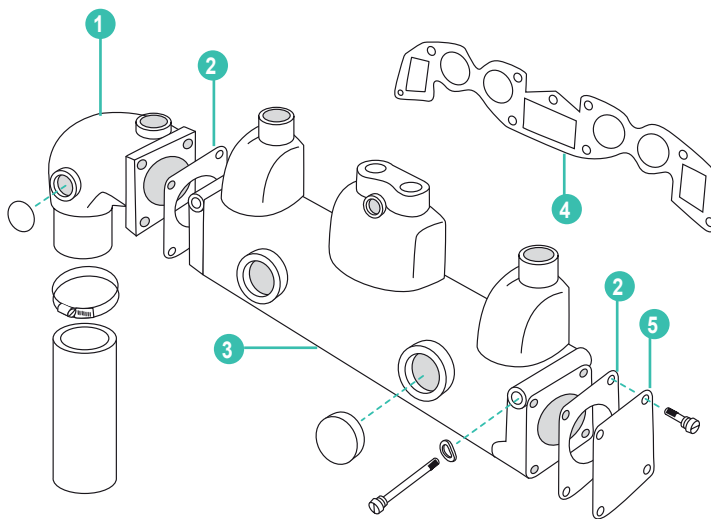

	REF	OEM				
1	HGE5599	825599	CODO ESCAPE	EXHAUST ELBOW	GOMITO SCARICO	COUDE D'ÉCHAPPEMENT
2	REC856028	856028	JUNTA TAPA	GASKET CAP	GUARNIZIONE COPERCHIO	JOINT DE PLAQUE
3	HGE4532	824532	COLECTOR DE ESCAPE	EXHAUST MANIFOLD	COLLETTORE SCARICO	COLLECTEUR D'ÉCHAPPEMENT
4	REC856044	856044	JUNTA COLECTOR ESCAPE	GASKET EXHAUST MANIFOLD	GUARNIZIONE COLLETTORE	JOINT DE COLLECTEUR
5	REC806341	806341	TAPA COLECTOR	CAP	COPERCHIO	PLAQUE DE COLLECTEUR

AQ120B • AQ125A, B • AQ131A, B, C, D • AQ140A • BB140A  
AQ145A, B • BB145A • AQ151A, B, C • 230A, B • 250A, B



REF  
TEN02022T



REF  
HOT20930-MK

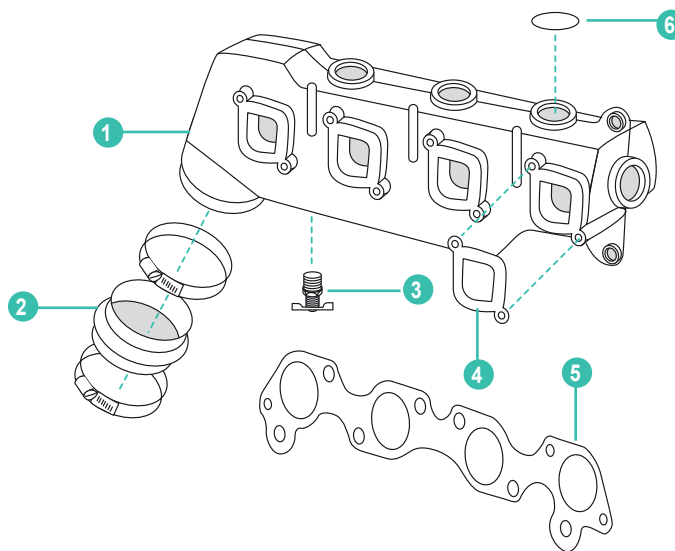

	REF	OEM				
1	HOT20930	855387	COLECTOR ESCAPE	EXHAUST MANIFOLD	COLLETTORE SCARICO	COLLECTEUR D'ÉCHAPPEMENT
2	REC834871	834871	FUELLE ESCAPE COLECTOR	BELLOW	CUFFIA	SOUFFLET
3	REC82745	997641	TAPÓN DRENAJE	FITTING PLUG	TAPPO DI DRENAGGIO	BOUCHON DE VIDANGE
4	REC855967	855967	JUNTA COLECTOR	GASKET MANIFOLD	GUARNIZIONE COLLETTORE	JOINT DE COLLECTEUR
5	REC1378879	1378879	JUNTA COLECTOR ADMISIÓN	GASKET INTAKE MANIFOLD	GUARNIZIONE COLLETTORE ASPIRAZIONE	JOINT DE COLLECTEUR D'ADMISSION
6	REC968955	60112158	TAPÓN	PLUG	TAPPO	BOUCHON

### 3.0L GM

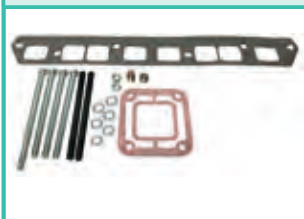

REF  
BAOMC-1-3858850P



REF  
MAR870-MK

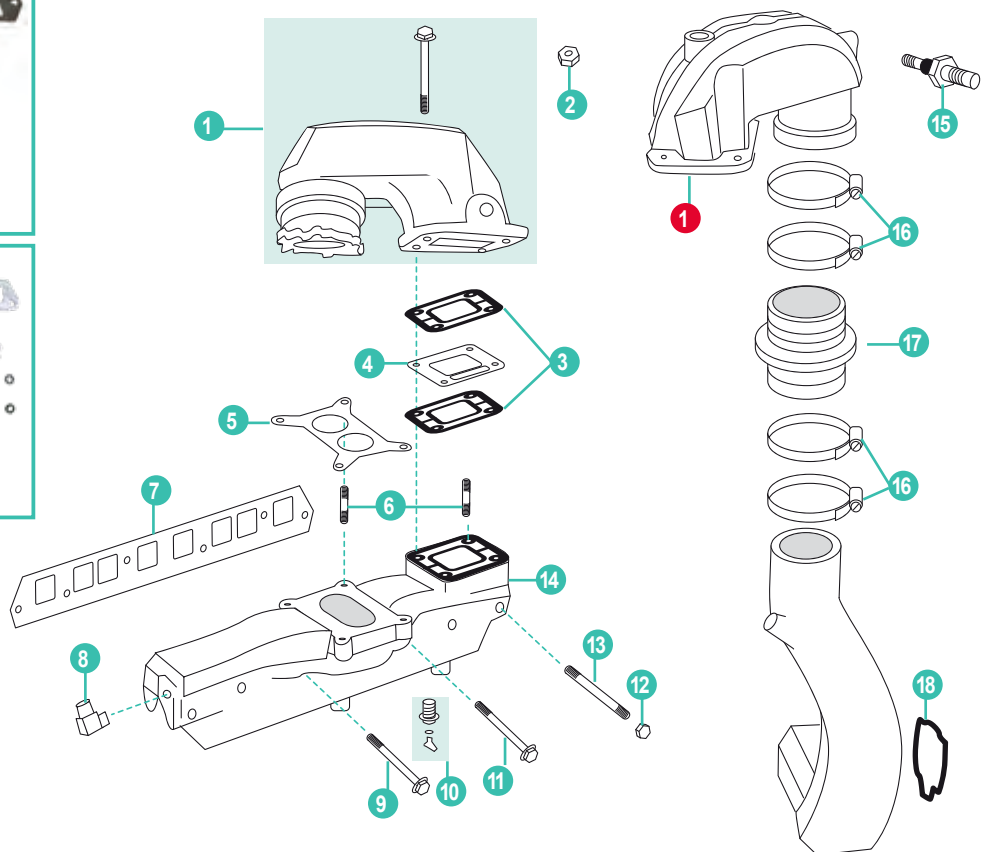

	REF	OEM				
1	BAOMC20-910380	3850799	CODO ESCAPE (3.0L MD)	EXHAUST ELBOW (3.0L MD)	GOMITO SCARICO (3.0L MD)	COUDE D'ÉCHAPPEMENT (3.0L MD)
1	BAOMC-20-3862603	3863071	CODO ESCAPE	EXHAUST ELBOW	GOMITO SCARICO ORIGINALE	COUDE D'ÉCHAPPEMENT
1	MAR684	3588684	CODO ESCAPE (3.0L GLM - C & 3.0L GLP - C/D/E/J/N)	EXHAUST ELBOW (3.0L GLM - C & 3.0L GLP - C/D/E/J/N)	GOMITO SCARICO (3.0L GML - C E 3.0L GLP - C/D/E/J/N)	COUDE D'ÉCHAPPEMENT (3.0L GLM - C & 3.0L GLP - C/D/E/J/N)
2	REC3852142	3852142	TUERCA CODO	NUT - EXHAUST ELBOW	DADO GOMITO	ÉCROU
3	REC3850495	3850495	JUNTA CODO ESCAPE	GASKET - EXHAUST ELBOW	GUARNIZIONE GOMITO SCARICO	JOINT DE COUDE
4	REC3853628	3853628	PLACA INTERMEDIA	INTERMEDIATE PLATE	PIASTRA INTERMEDIA	PLAQUE INTERMEDIAIRE
5	REC3853283	3853283	JUNTA CARBURADOR	GASKET - CARBURETOR	GUARNIZIONE CARBURATORE	JOINT DE CARBURATEUR
6	REC16-70236	3853373	PERNO	STUD - EXHAUST MANIFOLD	PERNO	VIS
7	REC27-815528	3853256	JUNTA COLECTOR ESCAPE	GASKET - EXHAUST MANIFOLD	GUARNIZIONE COLLETORE SCARICO	JOINT DE COLLECTEUR D'ÉCHAPPEMENT
8	REC3852538	3852538	RÁCOR COLECTOR	ELBOW FITTING - EXHAUST MANIFOLD	RACCORDO COLLETORE	RACCORD COUDE
9	REC3853430	3853430	TORNILLO	SCREW	VITE	VIS
10	REC13980	3850802	RÁCOR COLECTOR	STRAIGHT FITTING - WATER DRAIN	RACCORDO COLLETORE	RACCORD COUDE
11	REC3853431	3853431	TORNILLO	SCREW	VITE	VIS
12	REC46335	3853404	TUERCA	LOCKNUT	DADO	ÉCROU
13	REC3853378	3853378	ESPÁRRAGO	STUD - EXHAUST MANIFOLD	PERNO	VIS
14	MAR870	3858870	COLECTOR ESCAPE	EXHAUST MANIFOLD ASSEMBLY	COLLETORE SCARICO	COLLECTEUR D'ÉCHAPPEMENT
14	HGE8870	3858870	COLECTOR ESCAPE	EXHAUST MANIFOLD ASSEMBLY	COLLETORE SCARICO	COLLECTEUR D'ÉCHAPPEMENT
15	REC3862500	38622500	SENSOR TEMPERATURA	TEMPERATURE SENDER	SENSORE TEMPERATURA	SONDE DE TEMPÉRATURE
16	GS38320	3852604	ABRAZADERA	CLAMP	FASCETA	COLLIER
17	REC3863450	3863450	MANGUITO	EXHAUST HOSE	MANICOTTO	DURITE
18	RM3587651	3587651	JUNTA CUERNO ESCAPE	GASKET EXHAUST PIPE	GUARNIZIONE CORNA DI SCARICO	JOINT DE CORNE D'ÉCHAPPEMENT

## 6L AQ 165 & 170 A, B, C

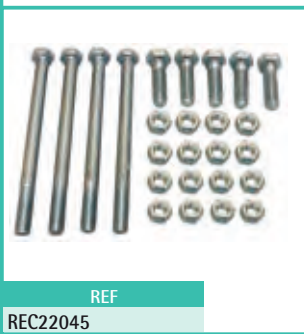

REF  
REC22045

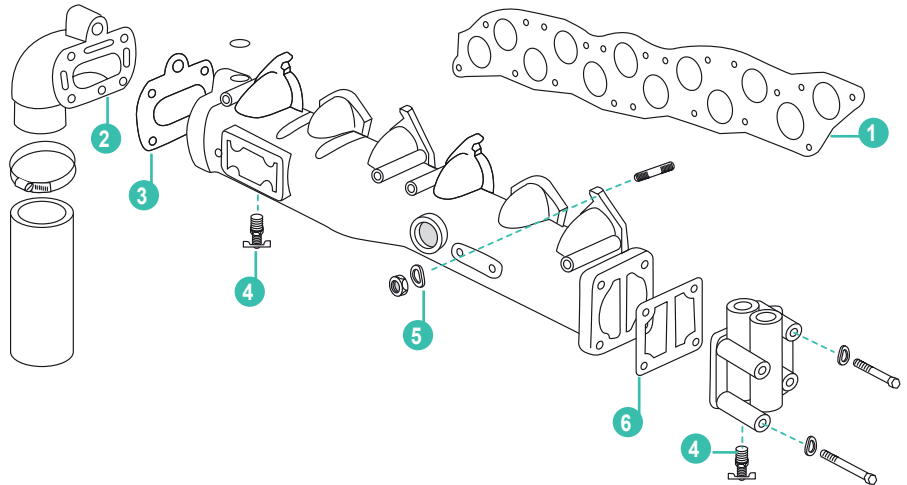

	REF	OEM				
1	REC1378913	461092	JUNTA COLECTOR ADMISIÓN - ESCAPE	GASKET EXHAUST-INTAKE MANIFOLD	GUARNIZIONE COLLETTORE ASPIRAZIONE-SCARICO	JOINT DE COLLECTEUR ADMISSION-ÉCHAPPEMENT
2	RM831834-7	831834	CODO ESCAPE	EXHAUST ELBOW	GOMITO SCARICO	COUDE D'ÉCHAPPEMENT
3	REC856042	856042	JUNTA CODO	ELBOW GASKET	GUARNIZIONE GOMITO	JOINT DE COUDE
4	REC82744	82744	TAPÓN DRENAJE	FITTING PLUG	TAPPO DI DRENAGGIO	BOUCHON DE VIDANGE
5	REC941907	941907	ARANDELA	WASHER	RONDELLA	RONDELLE
6	REC856036	856036	JUNTA TAPA	CAP GASKET	GUARNIZIONE COPERCHIO	JOINT DE PLAQUE

## V6 AQ 175 • AQ 205 • AQ430 A/B • 431 A/B • AQ 434 (-1993)



REF  
REC22145

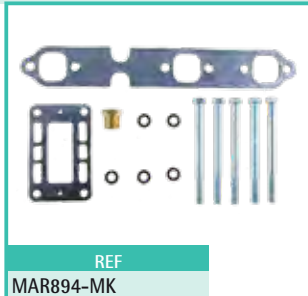

REF  
MAR894-MK

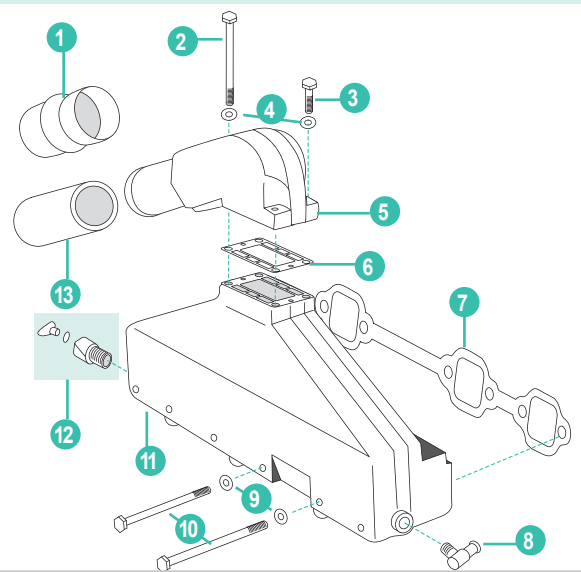

	REF	OEM				
1	REC854935	854935	MANGUITO ESCAPE	EXHAUST HOSE	MANICOTTO SCARICO	DURITE D'ÉCHAPPEMENT
2	REC959796	959796	TORNILLO	SCREW	VITE	VIS
3	REC940136	940136	TORNILLO	SCREW	VITE	VIS
4	REC941907	941907	ARANDELA	WASHER	RONDELLA	RONDELLE
5	HGE7037 MAR037	857037	CODO ESCAPE	EXHAUST ELBOW	GOMITO SCARICO	COUDE D'ÉCHAPPEMENT
6	REC857618	857618	JUNTA CODO ESCAPE NO HGE	GASKET - EXHAUST ELBOW NOT FOR HGE	GUARNIZIONE GOMITO SCARICONO PER HGE	JOINT DE COUDE PAS POUR LES HGE
	HGE35908		JUNTA CODO ESCAPE PARA HGE	GASKET - EXHAUST ELBOW FOR HGE	GUARNIZIONE GOMITO SCARICO PER HGE	JOINT DE COUDE POUR HGE
7	REC27-99757	856116	JUNTA COLECTOR ESCAPE	GASKET - EXHAUST MANIFOLD	GUARNIZIONE COLLETTORE SCARICO	JOINT COLLECTEUR D'ÉCHAPPEMENT
8	REC3852538	3852538	RÁCOR COLECTOR	HOSE FITTING	RACCORDO COLLETTORE	RACCORD COLLECTEUR
9	REC942336	942336	ARANDELA	WASHER	RONDELLA	RONDELLE
10	REC942547	942547	TORNILLO	SCREW	VITE	VIS
11	HGE6894 MAR894	856894	COLECTOR ESCAPE	EXHAUST MANIFOLD	COLLETTORE SCARICO	COLLECTEUR D'ÉCHAPPEMENT
12	REC479956	479956	RÁCOR DRENAJE	FITTING PLUG	RACCORDO DI DRENAGGIO	RACCORD DE VIDANGE
13	REC834751	834751	MANGUITO ESCAPE	EXHAUST HOSE	MANICOTTO SCARICO	DURITE D'ÉCHAPPEMENT



**V6 4.3L GM 262 CID  
(1993+)**



REF  
REC53773



REF  
MAR061-MK

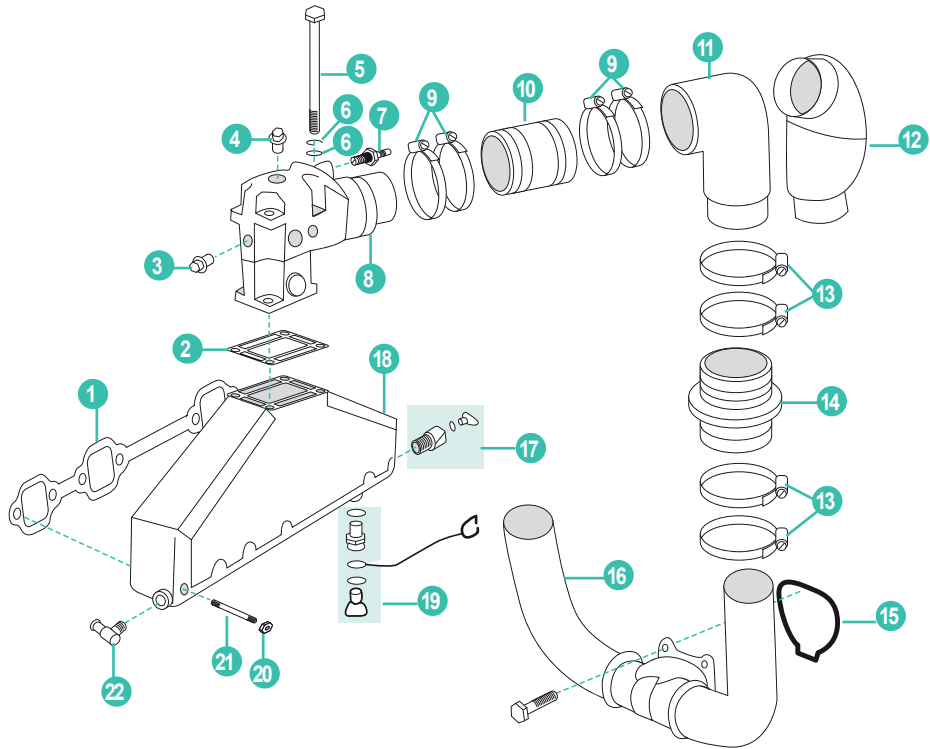

RISER 6"

REF OEM  
REC3842853 3842853



8

28.7 cm



8

19.7 cm



8

25.7 cm

	REF	OEM				
1	REC27-99757	3853412	JUNTA COLECTOR ESCAPE	GASKET - EXHAUST MANIFOLD	GUARNIZIONE COLLETTORE SCARICO	JOINT DE COLLECTEUR D'ÉCHAPPEMENT
2	REC3863191	3863191	JUNTA CODO ESCAPE	GASKET - EXHAUST ELBOW	GUARNIZIONE GOMITO SCARICO	JOINT DE COUDE D'ÉCHAPPEMENT
3	REC22-428611	3852135	TAPÓN	PLUG	TAPPO	BOUCHON
4	REC22-73379	3850740	TAPÓN	PLUG	TAPPO	BOUCHON
5	REC3852830	3852830	TORNILLO	SCREW	VITE	VIS
6	REC13-35048	3852002 3852058	ARANDELA	GROOVER	RONDELLA	RONDELLE
7	REC3862500	3862500	SENSOR TEMPERATURA	TEMPERATURE SENSOR	SENSORE TEMPERATURA	SONDE DE TEMPÉRATURE
	MAR061	3863061	CODO ESCAPE 19.7cm	EXHAUST ELBOW 19.7cm	GOMITO SCARICO 19.7cm	COUDE D'ÉCHAPPEMENT 19.7 mm
8	REC3889964 MAR964	3889964	CODO ALTO 25.7 cm	EXHAUST ELBOW 25.7 cm	GOMITO SCARICO 25.7 cm	COUDE D'ÉCHAPPEMENT 25.7 mm
	MAR627	3862627	CODO ALTO 28.7 cm	EXHAUST ELBOW 28.7 cm	GOMITO SCARICO 28.7 cm	COUDE D'ÉCHAPPEMENT 28.7 mm
9	GS38322	3863443	ABRAZADERA	CLAMP	FASCETTA	COLLIER
10	REC3852696	3852696	MANGUITO ESCAPE	EXHAUST HOSE	MANICOTTO SCARICO	DURITE D'ÉCHAPPEMENT
11	RM3863189	3863189	CURVA ESCAPE	EXHAUST CURVE	CURVA SCARICO	COUDE ECHAPPEMENT
12	RM3854874	3854874	CURVA ESCAPE 4.3L COLA SX	EXHAUST CURVE	CURVA SCARICO 4.3L PIEDE SX	COUDE ECHAPPEMENT 4.3L EMBASE SX
13	GS38320	3852604	ABRAZADERA	CLAMP	FASCETTA	COLLIER
14	REC3863450	3863450	MANGUITO ESCAPE	EXHAUST HOSE	MANICOTTO SCARICO	DURITE D'ÉCHAPPEMENT
15	RM3587651	3587651	JUNTA ESCAPE	EXHAUST GASKET	GUARNIZIONE SCARICO	JOINT DE CORNE
16	RM3858873	3858873	CUERNOS ESCAPE SX	EXHAUST TUBO SX	CORNA DI SCARICO SX	CORNE D'ÉCHAPPEMENT SX
17	REC479956	479956	RÁCOR COLECTOR	STRAIGHT FITTING KIT	RACCORDO COLLETTORE	RACCORD COLLECTEUR
18	MAR499	3847499	COLECTOR ESCAPE	EXHAUST MANIFOLD ASSEMBLY	COLLETTORE SCARICO	COLLECTEUR D'ÉCHAPPEMENT
19	REC38201	21114522	KIT TAPÓN DRENAJE	FITTING PLUG KIT	KIT TAPPO DI DRENAGGIO	KIT BOUCHON VIDANGE
20	REC46335	3853404	TUERCA	NUT	DADO	ÉCROU
21	REC3852467	3852467	ESPÁRRAGO	STUD	VITE	VIS
22	REC3852538	3852538	RÁCOR CODO	ELBOW FITTING	RACCORDO GOMITO	RACCORD COUDE

AQ & BB 200, 205, 211, 231, 225, 260, 271, 290, 311, 500, 501,  
570, 571, 572 GM 305/350 CID, (-1993)



REF OEM  
REC834751 834751



REF  
HOT20931-MK



REF  
HOT20935-MK

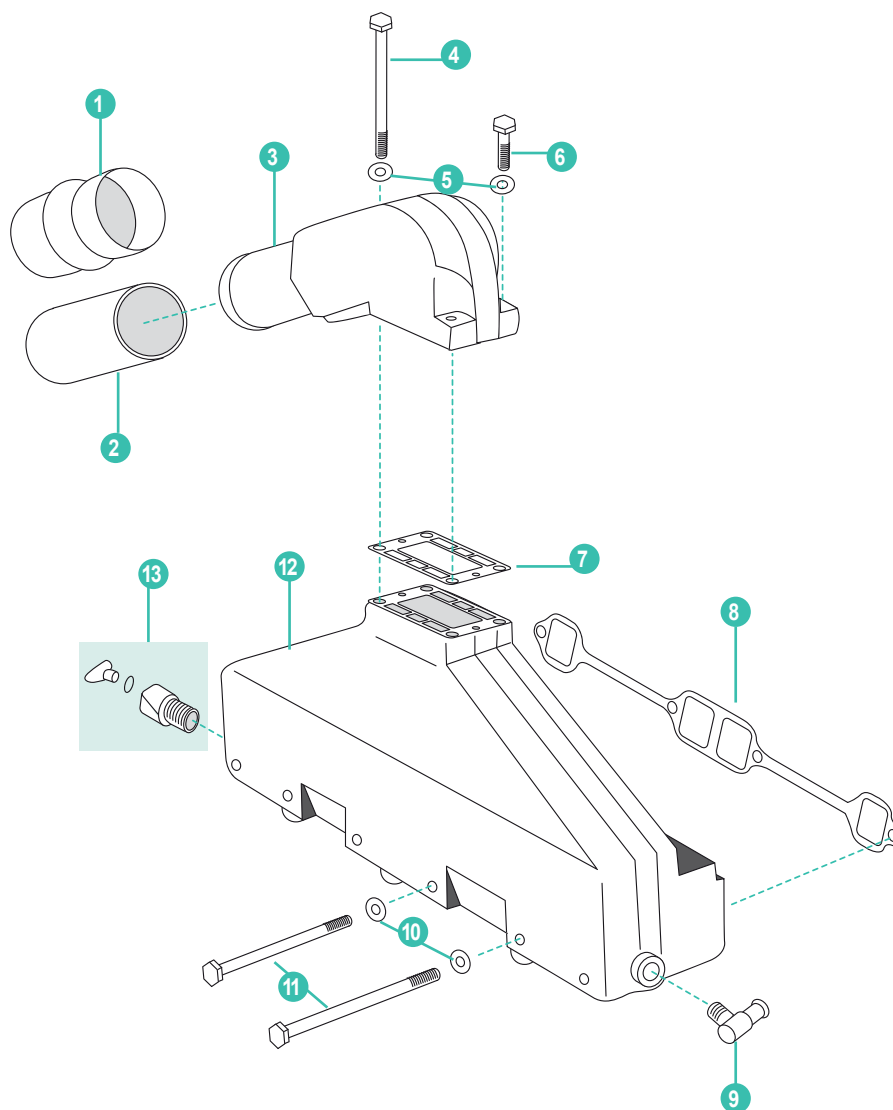

	REF	OEM				
1	REC854935	854935	MANGUITO ESCAPE	EXHAUST HOSE	MANICOTTO SCARICO	DURITE D'ÉCHAPPEMENT
2	REC834751	834751	MANGUITO ESCAPE	EXHAUST HOSE	MANICOTTO SCARICO	DURITE D'ÉCHAPPEMENT
3	HOT20935	856891	CODO ESCAPE	EXHAUST ELBOW ASSEMBLY	GOMITO SCARICO	COUDE D'ÉCHAPPEMENT
4	REC959794	959794	TORNILLO	SCREW	VITE	VIS
5	REC941907	941907	ARANDELA	WASHER	RONDELLA	RONDELLE
6	REC940136	940136	TORNILLO	SCREW	VITE	VIS
7	REC857618	857618	JUNTA CODO ESCAPE	GASKET - EXHAUST ELBOW	GUARNIZIONE GOMITO SCARICO	JOINT DE COUDE D'ÉCHAPPEMENT
8	REC27-33395	856034	JUNTA COLECTOR ESCAPE	GASKET - EXHAUST MANIFOLD	GUARNIZIONE COLLETTORE SCARICO	JOINT DE COLLECTEUR D'ÉCHAPPEMENT
9	REC3852538	3852538	RÁCOR COLECTOR	HOSE FITTING	RACCORDO GOMITO	RACORD DE COLLECTEUR
10	REC942336	942336	ARANDELA	WASHER	RONDELLA	RONDELLE
11	REC942547	942547	TORNILLO	SCREW	VITE	VIS
12	HOT20931	856883	COLECTOR ESCAPE	EXHAUST MANIFOLD ASSEMBLY	COLLETTORE SCARICO	COLLECTEUR D'ÉCHAPPEMENT
13	REC479956	479956	RÁCOR DRENAJE	STRAIGHT FITTING KIT	RACCORDO DI DRENAGGIO	RACCORD DE VIDANGE

**V8 5.0/5.7L GM305 & GM 350 CID  
(1993+)**

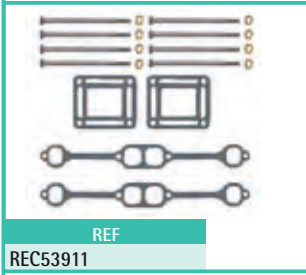

REF  
REC53911

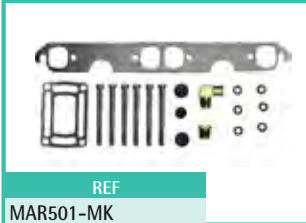

REF  
MAR501-MK



REF  
MAR061-MK

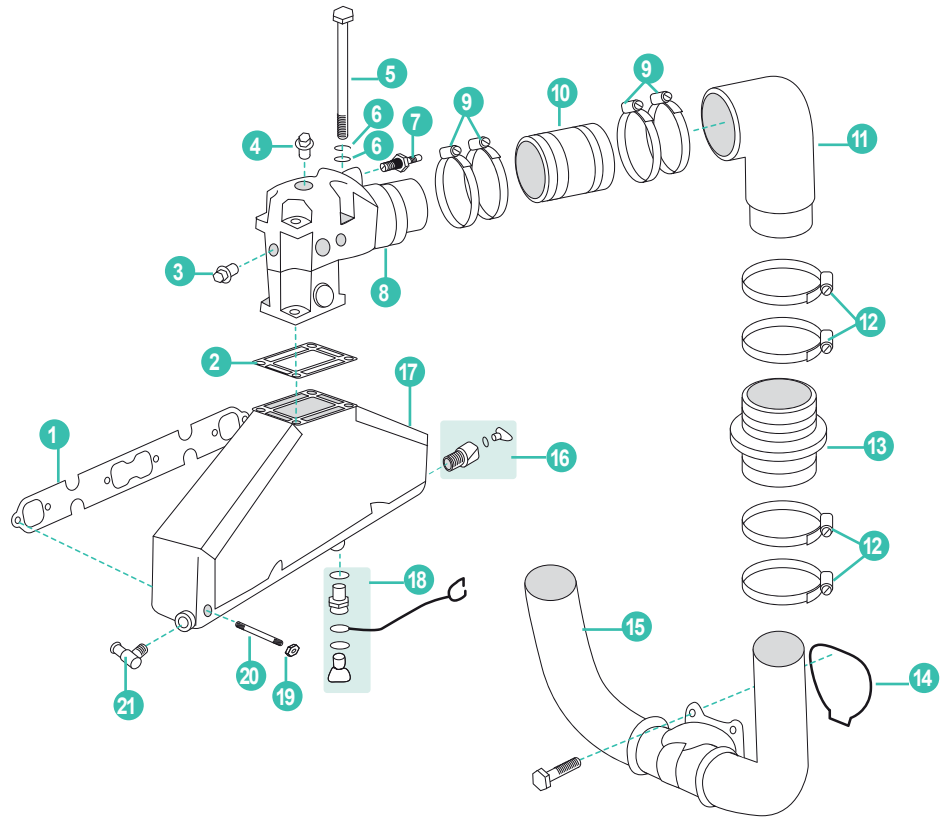

RISER 6"  
REF OEM  
REC3842853 3842853



8  
28.7 cm



8  
19.7 cm



8  
25.7 cm

	REF	OEM				
1	REC27-33395	3852468	JUNTA COLECTOR ESCAPE	GASKET - EXHAUST MANIFOLD	GUARNIZIONE COLLETORE SCARICO	JOINT DE COLLECTEUR D'ÉCHAPPEMENT
2	REC3863191	3863191	JUNTA CODO ESCAPE	GASKET - EXHAUST ELBOW	GUARNIZIONE GOMITO SCARICO	JOINT DE COUDE D'ÉCHAPPEMENT
3	REC22-428611	3852135	TAPÓN	PLUG	TAPPO	BOUCHON
4	REC22-73379	3850740	TAPÓN	PLUG	TAPPO	BOUCHON
5	REC3852830	3852830	TORNILLO	SCREW	VITE	VIS
6	REC13-35048	3852002 3852058	ARANDELA	GROOVER	RONDELLA	RONDELLE
7	REC3862500	3862500	SENSOR TEMPERATURA	TEMPERATURE SENSOR	SENSORE TEMPERATURA	SONDE DE TEMPÉRATURE
8	MAR061	3863061	CODO ESCAPE 19.7cm	EXHAUST ELBOW 19.7cm	GOMITO SCARICO 19.7cm	COUDE D'ÉCHAPPEMENT 19.7 mm
8	REC3889964 MAR964	3889964	CODO ALTO 25.7 cm	EXHAUST ELBOW 25.7 cm	GOMITO SCARICO 25.7 cm	COUDE D'ÉCHAPPEMENT 25.7 mm
8	MAR627	3862627	CODO ALTO 28.7 cm	EXHAUST ELBOW 28.7 cm	GOMITO SCARICO 28.7 cm	COUDE D'ÉCHAPPEMENT 28.7 mm
9	GS38322	3863443	ABRAZADERA	CLAMP	FASCETTA	COLLIER
10	REC3852696	3852696	MANGUITO ESCAPE	EXHAUST HOSE	MANICOTTO SCARICO	DURITE D'ÉCHAPPEMENT
11	RM3863189	3863189	CURVA ESCAPE MODERNO	EXHAUST CURVE	CURVA SCARICO MODERNO	COUDE ÉCHAPPEMENT MODERNE
12	GS38320	3852604	ABRAZADERA	CLAMP	FASCETTA	COLLIER
13	REC3863450	3863450	MANGUITO ESCAPE	EXHAUST HOSE	MANICOTTO SCARICO	DURITE D'ÉCHAPPEMENT
14	RM3587651	3587651	JUNTA ESCAPE	EXHAUST GASKET	GUARNIZIONE SCARICO	JOINT DE CORNE
15	RM3858873	3858873	CUERNOS ESCAPE SX	EXHAUST TUBO SX	CORNA DI SCARICO SX	CORNE D'ÉCHAPPEMENT SX
16	REC479956	479956	RÁCOR DRENAJE	STRAIGHT FITTING KIT	RACCORDO DI DRENAGGIO	RACCORD DE VIDANGE
17	MAR501	3847501	COLECTOR ESCAPE	EXHAUST MANIFOLD ASSEMBLY	COLLETORE SCARICO	COLLECTEUR D'ÉCHAPPEMENT
18	REC38201	38201	KIT TAPÓN DRENAJE	FITTING PLUG KIT	KIT TAPPO DI DRENAGGIO	KIT BOUCHON DE VIDANGE
19	REC46335	3853404	TUERCA	NUT	DADO	ÉCROU
20	REC3852467	3852467	PERNO	STUD	VITE	VIS
21	REC3852538	3852538	RÁCOR COLECTOR	ELBOW FITTING	RACCORDO COLLETORE	RACCORD DE COLLECTEUR

5.0/5.8L FI/FSI FORD 302/351 CID V8  
(1993+)

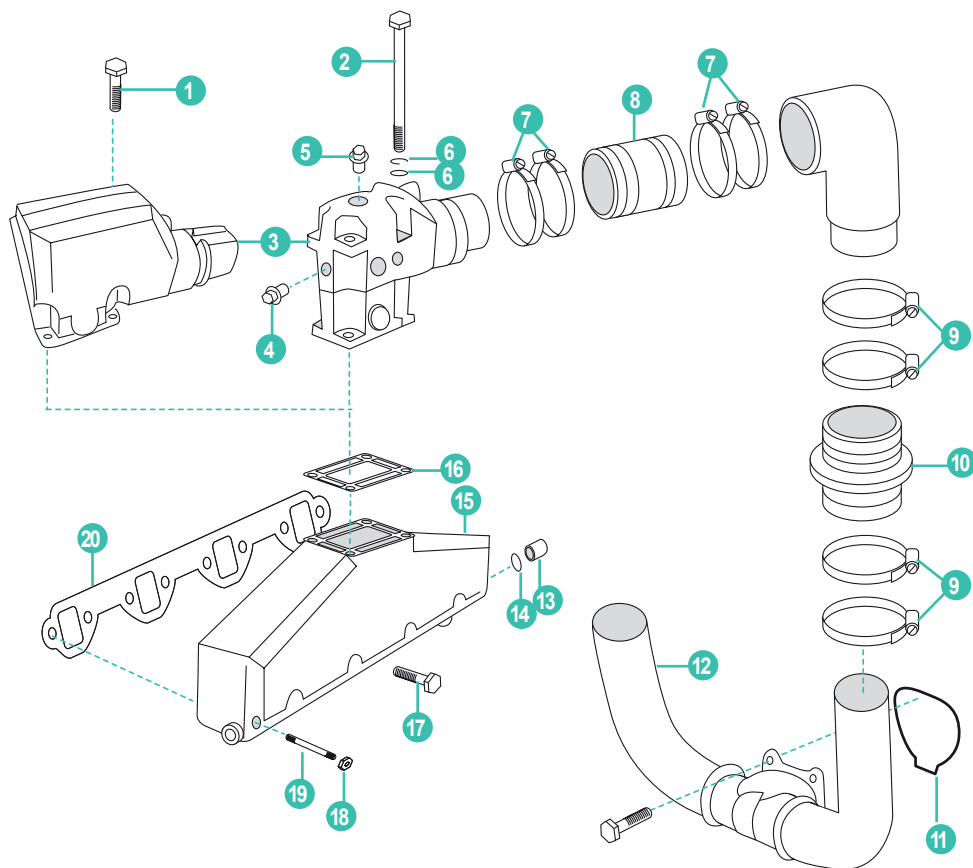

	REF	OEM				
1	REC10-37612	3855983	TORNILLO (1993-96 EFI)	SCREW (1993-96 EFI)	VITE (1993-96 EFI)	VIS (1993-96 EFI)
2	REC3852830	3852830	TORNILLO (1988-96 CARBURACION)	SCREW (1988-96 CARBURATION)	VITE (1988-96 CARBURATORE)	VIS (1988-96 CARB)
	MAR061	3863061	CODO ESCAPE 19.7 cm	EXHAUST ELBOW ASSEMBLY 19.7 cm	GOMITO SCARICO 19.7 cm	COUDE D'ÉCHAPPEMENT 19.7 mm
3	REC3855271	3855271	CODO ESCAPE EFI BABOR	EXHAUST ELBOW - PORT (EFI)	GOMITO SCARICO EFI BABORDO	COUDE D'ÉCHAPPEMENT EFI (BABORD)
	REC3855269	3855269	CODO ESCAPE EFI ESTRIBOR	EXHAUST ELBOW - STBD (EFI)	GOMITO SCARICO EFI TRIBORDO	COUDE D'ÉCHAPPEMENT EFI (TRIBORD)
4	REC22-428611	3852135	TAPÓN	PLUG	TAPPO	BOUCHON
5	REC22-73379	3850740	TAPÓN	PLUG	TAPPO	BOUCHON
6	REC13-35048	3852002 3852058	CIERRE	LOCKWASHER	CHIUSURA	RONDELLE
7	GS38322	3863443	ABRAZADERA	CLAMP	FASCETTA	COLLIER
8	REC3852696	3852696	MANGUITO ESCAPE	EXHAUST HOSE	MANICOTTO SCARICO	DURITE D'ÉCHAPPEMENT
9	GS38320	3852604	ABRAZADERA	CLAMP	FASCETTA	COLLIER
10	REC3863450	3863450	MANGUITO ESCAPE	EXHAUST HOSE	MANICOTTO SCARICO	DURITE D'ÉCHAPPEMENT
11	RM3587651	3587651	JUNTA ESCAPE	EXHAUST GASKET	GUARNIZIONE SCARICO	JOINT D'E CORNE
12	RM3858873	3858873	CUERNOS ESCAPE SX	EXHAUST TUBO SX	CORNA DI SCARICO SX	CORNE D'ÉCHAPPEMENT SX
13	REC3852476	3852476	TAPA	CAP	COPERCHIO	COUVERCLE
14	REC3852602	3852602	ABRAZADERA	CLAMP	FASCETTA	COLLIER
15	BAOMC1-3852347	3852347	COLECTOR ESCAPE	EXHAUST MANIFOLD ASSEMBLY	COLLETTORE SCARICO	COLLECTEUR D'ÉCHAPPEMENT
16	REC3863191	3863191	JUNTA CODO ESCAPE	GASKET - EXHAUST ELBOW	GUARNIZIONE GOMITO SCARICO	JOINT DE COUDE D'ÉCHAPPEMENT
17	REC10-37612	3853155	TORNILLO	SCREW	VITE	VIS
18	REC46335	3853404	TUERCA	NUT	DADO	ÉCROU
19	REC3853434	3853434	ESPÁRRAGO	STUD	PERNO	VIS
20	REC3852455	3852455	JUNTA COLECTOR ESCAPE	GASKET - EXHAUST MANIFOLD	GUARNIZIONE COLLETTORE SCARICO	JOINT DE COLLECTEUR D'ÉCHAPPEMENT



V8 7.4/8.2 GM 454/502 CID  
(1992+)

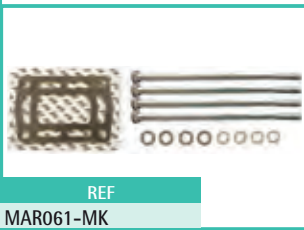

REF  
MAR061-MK



28.7 cm

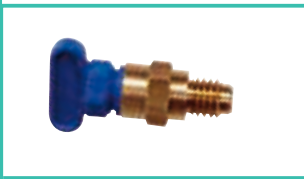

REC38201 21114522

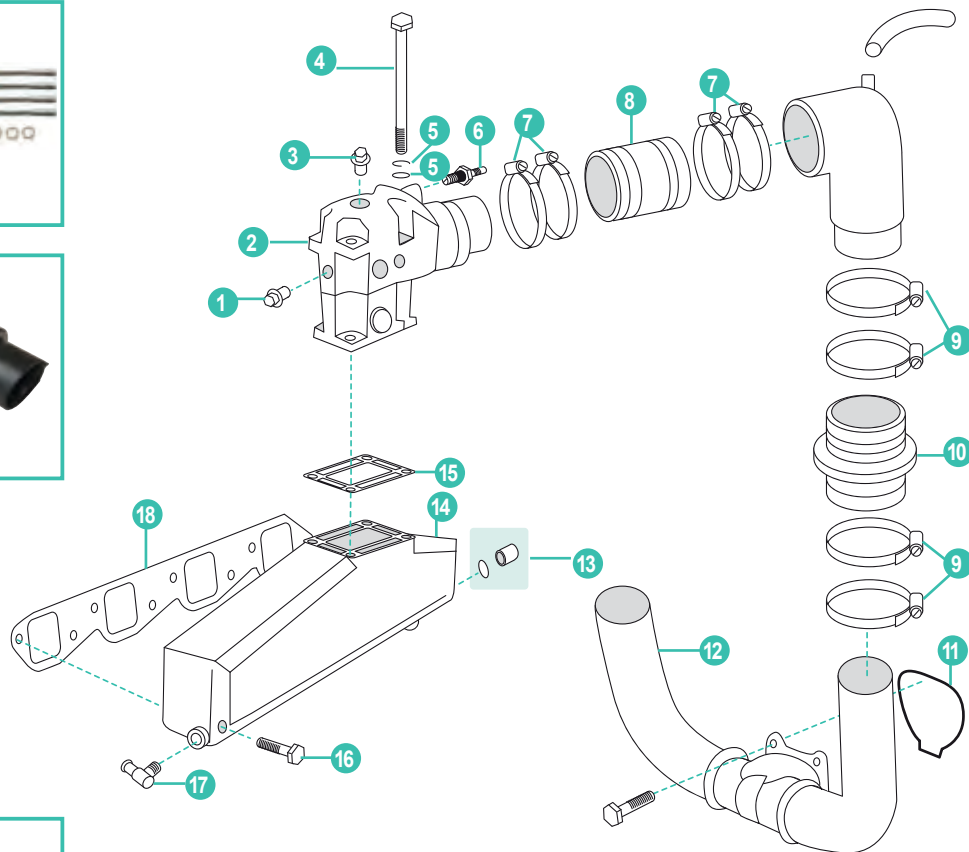

	REF	OEM				
1	REC22-428611	3852135	TAPÓN	PLUG	TAPPO	BOUCHON
	MAR061	3863061	CODO ESCAPE 19.7 cm	EXHAUST ELBOW ASSEMBLY 19.7 cm	GOMITO SCARICO 19.7 cm	COUDE D'ÉCHAPPEMENT 19.7 mm
2	MAR627	3862627	CODO ESCAPE ALTO 28.7 cm	EXHAUST ELBOW HIGH 28.7 cm	GOMITO SCARICO ALTO 28.7 cm	COUDE D'ÉCHAPPEMENT 28.7 mm
	REC3889964 MAR964	3889964	CODO ESCAPE ALTO 25.7 cm	EXHAUST ELBOW HIGH 25.7 cm	GOMITO SCARICO ALTO 25.7 cm	COUDE D'ÉCHAPPEMENT 25.7 mm
3	REC22-73379	3850740	TAPÓN	PLUG	TAPPO	BOUCHON
4	REC3852830	3852830	TORNILLO	SCREW	VITE	VIS
5	REC13-35048	3852002 3852058	CIERRE	LOCKWASHER	CHIUSURA	RONDELLE
6	REC3862500	3862500	SENSOR TEMPERATURA	TEMPERATURE SENSOR	SENSORE TEMEPERATURA	SONDE DE TEMPÉRATURE
7	GS38322	3863443	ABRAZADERA	CLAMP	FASCETTA	COLLIER
8	REC3852696	3852696	MANGUITO ESCAPE	EXHAUST HOSE	MANICOTTO SCARICO	DURITE D'ÉCHAPPEMENT
9	GS38320	3852604	ABRAZADERA	CLAMP	FASCETTA	COLLIER
10	REC3863450	3863450	MANGUITO ESCAPE	EXHAUST HOSE	MANICOTTO SCARICO	DURITE D'ÉCHAPPEMENT
11	RM3587651	3587651	JUNTA ESCAPE	EXHAUST GASKET	GUARNIZIONE SCARICO	JOINT DE CORNE
12	RM3858873	3858873	CUERNOS ESCAPE SX	EXHAUST TUBO SX	CORNA DI SCARICO SX	CORNE D'ÉCHAPPEMENT SX
13	REC479956	479956	RÁCOR COLECTOR	STRAIGHT FITTING KIT	RACORDO COLLETTORE	RACCORD DE COLLECTEUR
14	RM3861459	3861459	COLECTOR ESCAPE	EXHAUST MANIFOLD ASSEMBLY	COLLETTORE SCARICO	COLLECTEUR D'ÉCHAPPEMENT
15	REC3863191	3863191	JUNTA CODO ESCAPE	GASKET - EXHAUST ELBOW	GUARNIZIONE GOMITO SCARICO	JOINT DE COUDE D'ÉCHAPPEMENT
16	REC10-37612	3855983	TORNILLO	SCREW	PERNO	VIS
17	REC3852538	3852538	RÁCOR CODO	ELBOW FITTING	RACORDO GOMITO	RACCORD COUDE
18	REC27-46820	3852472	JUNTA COLECTOR ESCAPE	GASKET - EXHAUST MANIFOLD	GUARNIZIONE COLLETTORE SCARICO	JOINT DE COLLECTEUR D'ÉCHAPPEMENT

COLECTOR ADMISIÓN

INTAKE MANIFOLD

COLLETTORE ASPIRAZIONE



COLLECTEUR D'ADMISSION

TAPA DE COLECTOR



END CAP MANIFOLD

COPERCHIO COLLETTORE

COLLECTEUR

REF	OEM			
MP425024	3855805	8	GM 262, 4.3 (V6) VORTEC (2 bbl) Fe (1993+)	REC824326002



REF	OEM			
MP425113	3854100	16	740A, B 7.4 GLP	REC17340



REF	OEM			
MP425036	3855806	8	GM 262, 4.3 (V6) VORTEC (4 bbl) Fe (1993+)	REC824326002



VÁLVULA ADMISIÓN Y ESCAPE

INTAKE & EXHAUST VALVES

VALVOLE ASPIRAZIONE E SCARICO

SOUPAPES D'ADMISSION ET ECHAPEMENT



	ADMISIÓN INTAKE ASPIRAZIONE ADMISSION	ESCAPE EXHAUST SCARICO ÉCHAPPEMENT	GUÍA ADM. INTAKE GUIDE GUIDA ASPIR. GUIDE ADM.	GUÍA ESCAPE EXHAUST GUIDE GUIDA SCARICO GUIDE ECHAPP.	RETÉN VÁLVULA SEAL VALVE TENUTA VALVOLA JOINT HUILE SOUPAPE	MUELLE SPRING MOLLA RESSORT	CIERRE LOCK CHIUSURA CLAVETTE	EMPUJADOR LIFTER LIFTER CLAPET
AQ115A,B,C AQ120B AQ125A,B AQ131A,B,C,D AQ140A, BB140A AQ145A,B BB145A 230A,B, 250A,B	REC463395 44 mm OEM	REC463526 35 mm OEM	REC3582606 52x13,5x8mm OEM	REC3582609 52x13,5x8mm OEM	REC1306630 OEM	REC463739 OEM	REC419643 OEM	REC1218630 OEM
AQ115A,B BB115A,B,C AQ130A,B,C,D AQ165A, BB165A AQ170A, BB170A MB20A,B,C	463395 REC419734 42mm OEM 419734	463526 REC419735 35mm OEM 419735	419652 REC3582606 52x13,5x8mm OEM 419652	463371 REC3582561 52x13,5x8mm OEM 419653	1306630 REC1306630 OEM 1306630	463739 REC418737 OEM 418737	419643 REC419643 OEM 419643	418423 OEM OEM OEM
AQ171A,C 251A	REC1317793 34,5mm OEM 1317793	REC1317792 31,5mm OEM 1317792	REC3582608 55x12x7mm OEM 1378960	REC3582608 55x12x7mm OEM 1378960	REC3517893 OEM OEM 3517860	OEM OEM OEM	OEM OEM OEM	OEM OEM OEM





	ADMISIÓN INTAKE ASPIRAZIONE ADMISSION	ESCAPE EXHAUST SCARICO ÉCHAPPEMENT	GUÍA VÁLVULA VALVE GUIDE GUIDA VALVOLA GUIDE SOUPAPE	RETÉN VÁLVULA SEAL VALVE TENUTA VALVOLA JOINT QUEUE DE SOUPAPE	MUELLE SPRING MOLLA RESSORT	CIERRE LOCK CHIUSURA CLAVETTE
MD1B, 2B, 3B MD11C, D MD17C, D	REC833188 38mm OEM 833188	REC829620 34mm OEM 892260	OEM OEM OEM	REC1306630 OEM OEM 1306630	OEM OEM OEM	OEM OEM OEM
MD22A, A-A, L-A, L-B, P-B TMD22A, -A, -B, P-C TAMD22P-B	RM859650 OEM 859650	RM859656 OEM 859656	OEM OEM OEM	REC861860 OEM OEM REC22393048	OEM OEM OEM	OEM OEM OEM
MD2010A, B, C, D MD2020A, B, C, D	RM861858 OEM 861858	RM861859 OEM 861859	OEM OEM OEM	REC861860 OEM 861860	OEM OEM OEM	OEM OEM OEM
MD2030A, B, C, D	RM3580303 OEM 3580303	RM3580304 OEM 3580304	OEM OEM OEM	REC22393048 OEM 3580305	OEM OEM OEM	OEM OEM OEM
AQAD30A, MD30A, TAMD30A, TMD30A MD40A, TMD40A, B, C, AQD40A, TAMD40A, B AQAD40A, B	REC1542472 42mm OEM 1542472	REC1542389 36mm OEM 1542389	OEM OEM OEM	REC1306630 OEM OEM 1306630	REC1545198 OEM OEM 1545198	REC419643 OEM OEM 419643

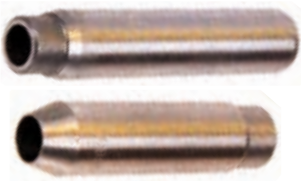

	ADMISIÓN INTAKE ASPIRAZIONE ADMISSION	ESCAPE EXHAUST SCARICO ÉCHAPPEMENT	GUÍA VÁLVULA VALVE GUIDE GUIDA VALVOLA GUIDE SOUPAPE	RETÉN VÁLVULA SEAL VALVE TENUTA VALVOLA JOINT QUEUE DE SOUPAPE	MUELLE SPRING MOLLA RESSORT	CIERRE LOCK CHIUSURA CLAVETTE
AQAD31A AD31A, B, L-A, P-A, D-A, XD TAMD31A, B, D, L-A, M-A, P-A, S-A TMD31A, B, D, L-A, MD31A KAD32P-A AQAD41A AD41A, B, D, L-A, P-A D41A, B, D, L-A TAMD41A, B, D, H-A, H-B, P-A, L-A, M-A TMD41A, B, D, L-A KAD42A, B, P-A, KAMD42A, B, P-A, TAMD42B, WJ-A KAD43P-A, KAMD43P-A	REC838637 39 mm OEM 833637	REC838638 37 mm OEM 838638	REC3582561 59x13,5x8mm OEM 419653	REC859171 OEM 21501189	REC1545198 OEM 1545198	OEM
D1-13A, B, F D1-20A, B, F	RM3809662 OEM 3809662	RM861859 OEM 861859	OEM	REC22393048 OEM 22393048	OEM	OEM
D1-30A, B, F D2-40A, B, F	RM3884528 OEM 3884528	RM3580304 OEM 3580304	OEM	OEM	OEM	OEM
D2-55A, B, C, D, E, F D2-60F D2-75A, B, C, F MD2040A, B, C, D	RM21186281 OEM 3580478	RM21186282 OEM 21307714	OEM	REC22393048 OEM 22393048	OEM	OEM
D3-110I-G, I-A, I-B, I-C, I-D, I-E, I-F, I-H D3-130A-A, A-B, A-C, I-A, I-B, I-C D3-140A-D, A-F, A-E, A-G, A-H, I-E, I-F, I-G, I-H D3-150I-D, I-E, I-F, I-G, I-H D3-160A-A, A-B, A-C, I-A, I-B, I-C D3-170A-D, A-E, A-F, A-G, A-H, I-D, I-E, I-F, I-G, I-H D3-190A-B, A-C, I-B, I-C D3-200A-D, A-E, A-F, A-G, A-H, I-D, I-E, I-F, I-G, I-H D3-220A-D, A-E, A-F, A-G, A-H, I-D, I-E, I-F, I-G, I-H D4-180I-B, I-C, I-D, I-E, I-F D4-210A-A, I-A, I-B D4-225A-E, A-C, A-D, A-F, I-B, I-C, I-D, I-E, I-F D4-260A-A, A-B, A-C, A-D, A-E, A-F, D-B, D-C, D-E, D-D, D-F, I-A, I-B, I-C, I-D, I-E, I-F D4-300A-A, A-C, A-D, A-E, A-F, D-A, D-C, D-D, D-E, D-F, I-A, I-C, I-D, I-E, I-F D6-280A-A, A-B, A-C, A-D, A-E, I-A, I-B, I-C, I-D, I-E D6-300A-F, D-F(MC), I-F D6-310A-A, A-B, A-C, A-D, A-E, D-B, D-C, D-E, D-D, I-A, I-B, I-C, I-D, I-E D6-330A-B, A-C, A-D, A-E, A-F, D-B, D-C, D-D, D-E, D-F, I-B, I-C, I-D, I-E, I-F D6-350A-A, A-B D6-370A-B, A-C, A-D, A-E, A-F, D-B, D-C, D-D, D-E, D-F, I-A, I-B, I-C, I-D, I-E, I-F D6-400A-E, A-F D6-435D-A, D-D, D-C, D-E, D-F, I-A, I-C, I-D, I-E, I-SC-F, I-WJ-F D9A2A D9-425, 500(R4), 575 D9A-MH, MG D9A2B D9-425, 500(R5), 575, MH D9A2C, D9A2E D9-425 D9A2F D9-575 D9A2G, H, J, K D11A-A, A-B, A-C, A-D, A-E, A-C(IPS), A-D(IPS) B1-A MP D11B2-A MP(IPS) D12D-A MH,-A MP,-B MH,-C MH,-G MH,-A MP,-B MP,-C MP,-D MP,-E MH,-E MP,-F MP,-G MP,-G MH,-H MP D12C-A MP, D12D-A MG,-E MG	RM8631650 OEM 8631650	OEM OEM 8631651	OEM	REC8631652 OEM 8631652 861700 877072 877073 8631652	OEM	OEM
D4-180I-B, I-C, I-D, I-E, I-F D4-210A-A, I-A, I-B D4-225A-E, A-C, A-D, A-F, I-B, I-C, I-D, I-E, I-F D4-260A-A, A-B, A-C, A-D, A-E, A-F, D-B, D-C, D-E, D-D, D-F, I-A, I-B, I-C, I-D, I-E, I-F D4-300A-A, A-C, A-D, A-E, A-F, D-A, D-C, D-D, D-E, D-F, I-A, I-C, I-D, I-E, I-F D6-280A-A, A-B, A-C, A-D, A-E, I-A, I-B, I-C, I-D, I-E D6-300A-F, D-F(MC), I-F D6-310A-A, A-B, A-C, A-D, A-E, D-B, D-C, D-E, D-D, I-A, I-B, I-C, I-D, I-E D6-330A-B, A-C, A-D, A-E, A-F, D-B, D-C, D-D, D-E, D-F, I-B, I-C, I-D, I-E, I-F D6-350A-A, A-B D6-370A-B, A-C, A-D, A-E, A-F, D-B, D-C, D-D, D-E, D-F, I-A, I-B, I-C, I-D, I-E, I-F D6-400A-E, A-F D6-435D-A, D-D, D-C, D-E, D-F, I-A, I-C, I-D, I-E, I-SC-F, I-WJ-F D9A2A D9-425, 500(R4), 575 D9A-MH, MG D9A2B D9-425, 500(R5), 575, MH D9A2C, D9A2E D9-425 D9A2F D9-575 D9A2G, H, J, K D11A-A, A-B, A-C, A-D, A-E, A-C(IPS), A-D(IPS) B1-A MP D11B2-A MP(IPS) D12D-A MH,-A MP,-B MH,-C MH,-G MH,-A MP,-B MP,-C MP,-D MP,-E MH,-E MP,-F MP,-G MP,-G MH,-H MP D12C-A MP, D12D-A MG,-E MG	RM3884010 OEM 3884010	RM3884015 OEM 3884015	OEM	REC861700 OEM 861700 877072 877073	REC3581889 OEM 3581889	OEM
D9-425, 500(R4), 575 D9A-MH, MG D9A2B D9-425, 500(R5), 575, MH D9A2C, D9A2E D9-425 D9A2F D9-575 D9A2G, H, J, K D11A-A, A-B, A-C, A-D, A-E, A-C(IPS), A-D(IPS) B1-A MP D11B2-A MP(IPS) D12D-A MH,-A MP,-B MH,-C MH,-G MH,-A MP,-B MP,-C MP,-D MP,-E MH,-E MP,-F MP,-G MP,-G MH,-H MP D12C-A MP, D12D-A MG,-E MG	OEM	OEM	OEM	OEM	REC3183211 REC21310068 OEM 3183211 21310068	OEM
D16C-A, MH,-A, MG,-B, MB,-C, MH	REC20739057 OEM 20739057	REC20513285 OEM 20513285	OEM	OEM	OEM 22527820	OEM
KAD44P-A, P-B, P-C, KAMD44P-A, P-C KAD300-A, KAMD300-A	REC861698 OEM 861698	REC861699 OEM 861699	OEM	REC861700 OEM 861700	REC1545198 OEM 1545198	OEM
THAMD70C, AQD70D,CL TMD70C, TAMD70C, D, E, MD70C TAMD71A, B, TAMD72A, P-A, WJ-A TAMD73P-A, WJ-A	OEM 466379	REC842080 OEM 842080	OEM OEM 466386	REC466384 REC466383 OEM 466384 466383	REC468305 OEM 468305	REC466382 OEM 466382

LIFTER	LIFTER	LIFTER	POUSSOIR HYDRAULIQUE
	REF	OEM	
AQ 60, 90, 95, 100, 105, 115, 120A, 130, 165, 170	REC1218630	1218630	

GUÍAS	GUIDE	SEDE	GUIDE
	ADMISIÓN INTAKE ASPIRAZIONE ADMISSION	ESCAPE EXHAUST SCARICO ÉCHAPPEMENT	
AQ120B, 125, 131, 140, 145, 151, 230, 250	REC3582606 3582606	REC3582609 3582609	
AQ171, 251	REC3582608 3582608	REC3582608 3582608	
AQ105, 115, 130, 165, 170 MD30, 31, 40, 41 KAD42 KAMD42	REC3582606 3582606	REC3582561 3582561	52 x 13.5 x 8 mm

MUELLES	SPRING	MOLLE	RESSORTS
		REF	OEM
AQ 90, 95, 100, 105, 110, 115, 120, 130, 165, 170, MB 18, 20, BB 30, 100, MD 31A (Versión antigua   Old style   versione vecchia   Version ancienne)		REC418737	418737
AQ 120B, 125, 131, 140, 145, 151, 230A, 250A		REC463739	463739
30, 31, 32, 40, 41, 42, 43		REC1545198	1545198
D4 D6		REC3581889	3581889

PISIONERO VÁLVULA	VALVE KEEPER	PRIGIONIERO VALVOLA	CLAVETTE DE SOUPAPE
		REF	OEM
AQ105, 115, 130, 165, 170, 120B, 125, 131, 140, 145, 151, 230A, 250A MB10A MD30, 40		REC419643	419643

## COLECTORES Y CODOS    MANIFOLDS & ELBOWS    COLLETTORE E GOMITI    COLLECTEURS ET COUDES

### MOTORES GASOLINA    GAS ENGINE    MOTORI BENZINA    MOTEUR ESSENCE







COLECTORES	MANIFOLDS	COLLETTORE	COLLECTEURS
REF	OEM		REF
			OEM
	230A, B 250A, B AQ120B AQ125A, B AQ131A, B, C, D AQ140A BB140A, AQ145A, B BB145A AQ151A, B, C		
HOT20930	855387 834438		MAR870 3858870 HGE8870 3858871 3857450 3854045
			3.0GPS, GSM, GLP, GLM
			



REF	OEM	
MAR894 HGE6894	430A, B	
	431A, B	
	432A	
	434A	
	AQ205A	
	AQ175A	
	V6 (-1993)	







REF	OEM	
MAR501	3847501	
	3857723	
	3852374	
	5.0GXI, OSI, GL, GI, GSI	
	5.7GI, GXI, GSI, GL, OSI, OSX	
	V8-270, 300, 320	





MAR501

MAR501

REF	OEM	
MAR499	3847499	
	3857656	
	3852338	
	3857678	
	4.3GL, GXI, GI, GS, OSI,	
	V6-200-A	
	V6-225-A	
	V6 (1993+)	







REF	OEM	
BAOMC1-3852347	3852347	
	5.0 & 5.8 FIP, FLP, FLI, FSI (Base Ford 302/351)	





REF	OEM		
HOT20931	AQ200D, F		
	AQ211A		
	AQ225D, E, F		
	BB225		
	AQ231A, B		
	BB231		
	AQ260A, B		
	BB260		
	856883		BB261
	855926		AQ271A, B, C, D
	835804		AQ290A
			AQ311A, B
			500A, B
			501A, B
			570A
			571A
			572A



REF	OEM	
RM3861459	3861459	
	3852362	
	7.4GLP, GLI, GI, GSI, GL	
	8.2GLP, GLI, GSI (454/502)	

REF	OEM	
HGE4532	824532	
	AQ115A, B	
	BB115A, B, C	
	AQ130A, B, C, D	



## CUERNOS DE ESCAPE SX

## EXHAUST TUBO SX

## CORNA DI SCARICO SX

CORNES D'ÉCHAPPEMENT  
SX

REF	OEM
RM3858873	3858873
	3850796
	3853915
	3855281
	3850794



## CODO

## ELBOW

## GOMITO

## COUDES

REF	OEM	
HGE5599	825599	AQ115A, B,
	825598	AQ130A, B, C, D



REF	OEM	
MAR684	3588684	3.0GLM-C
	3588683	3.0GLP-C, D, E, J, N
		(2003+)



REF	OEM	
BAOMC20-910380	3850799	3.0L MD



REF	OEM	
RM831834-7	831834	AQ170B, C



REF	OEM	
BAOMC-20-3862603	3863071	3.0GSP, GSM, GLP, GLM (1994-03)
	3857798	
	3856662	
	3851227	
	3856617	
	3857810	
	3857684	





REF	OEM	
MAR037 HGE7037		430A, B
		431A, B
	857037	432A
	856895	434A
	855380	AQ205A AQ175A



REF	OEM	
MAR061	3863061	V6 - V8 (1993+)
	3861842	
	3856444	
	3855270	
	3854466	
	3857402	
3862198	19.7 cm	





REF	OEM	
REC3855271	3855271	5.0FIP 5.8FIP, FII, FSI
	3850913	
	3853568	
	3854428	
	3855269	
REC3855269	3853567	ESTRIBOR   STD DESTRA   DROITE
	3854427	





REF	OEM	
MAR964	3889964	4.3GL, GXI, OSI V6-200, 225 (1993+)
REC3889964	3889965	
		25.7 cm



REF	OEM	
HOT20935	856891	500, 501, 570 ,572 AQ200, 211, 225, 231, 260, 271, 290, 311 BB225, 231, 260, 261
	855384	



REF	OEM	
MAR627	3862627	V6 - V8 (1993+)
	3862904	
		28.7 cm



**EXTENSORES DE ESCAPE    EXHAUST EXTENSOR    PROLUNGA SCARICO    COUDE D'ECHAPPEMENT**

REF	OEM	
RM3854874	3854874	4.3GL, GXI, OSI, GS, GI



REF	OEM	
RM3863189	3863189	V6 - V8



**RISER 6" (MAR061 & MAR501)    RISER 6" (MAR061 & MAR501)    RISER 6" (MAR061 E MAR501)    REHAUSSE 6" (MAR061 ER MAR501)**

REF	OEM
REC3842853	3842853





MOTORES DIESEL    DIESEL ENGINE    MOTORI DIESEL    MOTEUR DIESEL

CODO    ELBOW    GOMITO    COUDES



REF	OEM	
HGE5528	845528	TAMD40A, B AQAD40A, B TMD40B, C

Se instala en codo MAR261INOX o inverter MS3A/B  
 Installed in elbow MAR261INOX or inverter MS3A/B  
 Installato nel gomito MAR261INOX o inverter MS3A/B  
 A installer sur le coude MAR261INOX ou l'inverseur MS3A/B





REF	OEM			
MAR963	859963	31 & 41 (antiguo   old model   vecchio   Ancienne) TMD, TAMD, AQ, AD, MD	RM858955 CEF500530	REC842913





REF	OEM			
MAR289	861289 860656	32, 42, 43, 44, 300 31 & 41 (modernos   new   moderno   modernes) DS	RM860396	REC842913



REF	OEM		
MAR690	840690	2001, B, AG, BG 2002, B, AG, BG 2003, B	REC840902



REF	OEM		
MAR906 RM861906	861906 21190094	MD2010A, B, C, D MD2020A, B, C, D MD2030A, B, C, D MD2040C, D D1-13, 20, 30 D2-40	REC861907





REF	OEM		
MAR345	21424345 3589544 861574 859865	D2-50, 55 MD22	REC888596



REF	OEM		JUNTA CODO GASKET GUARNIZIONE JOINT DE COUDE	JUNTA TUBO AGUA WATER GASKET GUARNIZIONE TUBO ACQUA JOINT DU TUBE D'EAU
MAR583	833583	MD1, 2, 3, 11, 17	REC859015	REC859107



**new**

REF	OEM		
MAR512	3582512 861413	Serie 31 Et 41 MD22	REC859835 REC861414





**new**

REF	OEM			
MAR930	840930	2003T	REC859112	REC840933





**new**

**ABRAZADERA ESCAPE    EXHAUST CLAMP    FASCETTA SCARICO    COLLIER D'ÉCHAPPEMENT**

REF	OEM		
RM21325765	21325765 842993	30, 31, 32, 40, 41, 42, 43, 44, 300, D4	



REF	OEM		
REC21325767	21325767 3807212 3838942 865013	D4-300D D6, D7 D103, D61, D62, D63, D71, D742, D73, D74, D75	



**new**

REF	OEM	
REC840933	840933	2003T



**new**

**CODO ESCAPE  
INOX 316**
**316 SS EXHAUST ELBOW**



REF	OEM			
MAR701INOX	3884701 3583856	D4 (180-300)	REC3584167	REC969415





new

REF	OEM			
MAR847INOX	22948847 22671214 21700014 3583902	D6 (280-435)	REC3584168	REC969415



REF	OEM	
SED3091400	3830988 3826841 865545 3829668	TAMD63 P-A D71, 72, 73, 74, 7A, 7C TAMD73 P-A, 61, 103

REF	OEM			
MAR261INOX SED3091000	845261	30 Et 40 (Sin soporte   without mount   senza supporto   sans support)	RM843228	REC859011



**GOMITO DI SCARICO  
INOX 316**
**COUDE D'ÉCHAPPEMENT  
EN INOX 316**

REF	OEM			
MAR963INOX	859963	31 Et 41 (Sin soporte   without mount   senza supporto   sans support)	RM858955	REC842913



REF	OEM			
MAR289INOX SED3091200	861289 860656	KAD32P D5 31, 41, 42, 43, 44, 300	RM860396	REC842913

REF	OEM			
SED3091600	21684825 3841510 22948844 3587159 22671213	D6 AQ Et IPS	REC3584168	REC969415

REF	OEM		
SED3090900	861906 21190094	MD2010, 2020, 2030, 2040 D1-13, -20, -30 D2-40	REC861907

**PIPA CONEXIÓN PARA  
Codos**
**CONNECTOR FOR ELBOW**
**INNESTI PER GOMITI**
**PIPE DE COUDE  
D'ÉCHAPPEMENT**

REF	OEM	CODO ELBOW GOMITO COUDE	
REC859836	859836 3587410	MAR345 MAR512	REC859835

REF	OEM	CODO ELBOW GOMITO COUDE
REC21450768	21450768 3819016 3583915	D4 Et D6

Incluye Tórica  
O-ring included  
Include O-ring  
Comprend un joint torique

GUÍA CODO ESCAPE		EXHAUST ELBOW APPLICATION		GUIDA GOMITO DI SCARICO		GUIDE DES COUDES D'ÉCHAPPEMENT						
	CODO ELBOW GOMITO COUDE		CODO INOX SS ELBOW GOMITO INOX COUDE INOX		JUNTA GASKET GUARNIZIONE JOINT		ANILLO ORING FASCIA TONDA JOINT TORIQUE		ABRAZADERA TURBO TURBO CLAMP FASCETTA TURBO COLLIER		CONECTOR CONNECTOR CONNETTORI CONECTEUR	
	REF	OEM	REF	OEM	REF	OEM	REF	OEM	REF	OEM	REF	OEM
TMD30A TAMD30A AQAD30A TMD40A, B, C TAMD40A, B AQD40A AQAD40A, B TMD31A, B, D, L-A, P-A TAMD31A, B, D, L-A, M-A AQAD31A AD31, B MD31A TAMD41A, B, D, H-A, H-B, P-A, L-A, M-A TMD41A, B, D, L-A D41A, B AD41A, B, D AQAD41A AD31B, D-A, L-A, P-A, XD KAD32P D41B, D AD41B, D, L-A, P-A KAMD42A, P-A KAD42A, P-A TAMD42WJ-A KAMD43P-A KAD43P-A KAMD44P-A, P-C KAD44P, P-B, P-C KAD300-A KAMD300-A D5A-T, -TA D5A-B TA TAMD72WJ-A, P-A TAMD63L-A, P-A TAMD74C-A, C-B, L-A, L-B, P-A, P-B TAMD75P-A TAMD71A, B TAMD73P-A, WJ-A TAMD72A TAMD61A TAMD62A TAMD103A D7A-T, A-TA, A-B TA, C-TA, C-B TA D4-180I-B, I-C, I-D, I-E D4-210A-A, A-B, I-A, I-B D4-225A-A-C, A-D, A-E, I-B, I-C, I-D, I-E D4-260A-A, A-B, A-C, A-D, A-E, D-B, D-C, D-D, D-E, I-A, I-B, I-C, I-D, I-E D4-300A-A, A-C, A-D, A-E, D-A, D-C, D-E, D-DI-A, I-C, I-D, I-E D4-300-D-A, D-C, D-E, D-E (IPS) D6-280A-A, A-B, A-C, A-D, A-E D6-300A-F, D-F D6-310A-A, A-B, A-C, A-D, A-E, D-B, D-C, D-D, D-E D6-330A-B, A-C, A-D, A-E, A-F, D-B, D-C, D-D, D-E, D-F D6-350A-A, A-B D6-370A-B, A-C, A-D, A-E, A-F, D-A, D-B, D-C, D-D, D-E, D-F D6-400A-F D6-435D-F 2001, AG, B, BG 2002, AG, B, BG 2003, B MD2010A,B,-C,-D MD2020A,B,-C,-D MD2030A,B,-C,-D MD2040A,B,-C,-D D1-13, 13B, 13F D1-20, 20B, 20F D1-30, 30B, 30F D1-40, 40B, 40F D2-55A, B, C, D, E, F D2-50F MD22A, L-A, L-B, P-B 2003T 31 et 41 MD22 MD1,2,3,11,17			MAR261INOX SED3091000	845261	REC859011	859011			RM21325765	842993		
			MAR261INOX SED3091000	845261	REC859011	859011			RM21325765	842993	HGE5528	845528
	MAR963	859963	MAR963INOX	859963	REC859002	859002	REC842913	842913	RM21325765	842993		
	MAR289	861289	MAR289INOX SED3091200	861289	REC859002	859002	REC842913	842913	RM21325765	842993		
			SED3091400	3830988					REC21325767			
		3884701	MAR701INOX	3884701					RM21325765	842993	REC21450768	21450768
			MAR847INOX	22948847	REC3584168							
			SED3091600	21684825	REC969415				REC21325767		REC21450768	21450768
	MAR690	840690			REC840902	840902	REC418445	418445				
	MAR906 RM861906	861906	SED3090900	861906	REC861907	861907						
	MAR345	21424345			RM859834 REC888596	859834 888596					REC859836	859836
	MAR930	840930			REC859112							
	MAR512	358251 861413			REC859835 REC861414							
	MAR583	833583			REC859015							

## MANGUITOS DE ESCAPE

## EXHAUST HOSE

## MANICOTTO SCARICO

## DURITE D'ÉCHAPPEMENT

REF	OEM	
REC3584167	3584167	D4 DPH / DPR



REF	OEM	
REC3852696	3852696	4.3 (1991), 5.0-5.8 FORD (1991) 7.4 (460) (1988-89) 5.7LE (1990-91) Modelos modernos   Latest models   Modelli moderno   Modèles modernes 4.3 / 5.0 / 5.7 / 7.4 / 8.1



REF	OEM	
REC3584168	3584168	D6 DPH / DPR



REF	OEM	
REC3863450	3863450	2.5 (1986) 3.0 (1986-91) 2.3 (1989-90) 4.3 (1990-91) 5.0-5.8 FORD (1991) 5.7 (1986) Modelos modernos   Latest models   Modelli moderno   Modèles modernes 3.0 4.3 / 5.0 / 5.7 / 7.4 / 8.1 / D3



REF	OEM	
RM3853608	3853608	Ford 5.0 Et 5.8 HD, MD Et NC (Para codos   For elbows   per gomito   Pour coudes E.I.)



REF	OEM	
RM860396 CEF500531	860396	D31, 32, 41, 42, 43, 44, 300



REF	OEM	
REC834751	834751	160 mm x Ø in 95 mm AQ 175, 280, 430A, 431A V6 V8



REF	OEM	
REC952980	952980	200 mm x Ø in 57 mm AQ 60, 90, 95, 105, 110, 115, 120A, 130



REF	OEM	
RM843228	843228	AQ / AD 30, 40



REF	OEM	
RM858955 CEF500530	858955 858729	AQ 31, 41

KIT REPARACIÓN TUBO  
ESCAPEREPAIR KIT EXHAUST  
TUBEKIT RIPARAZIONE  
SCARICOKIT REPARATION POUR  
CORNE D'ÉCHAPPEMENT

REF	OEM	
RM3581114	3581114	3.5"
RM3581115	3581115	4"





# UNIDADES DE TRANSMISIÓN TRANSMISSION UNIT

# UNITÀ DI TRASMISSIONE EMBASES ET PIÈCES

## PISTONES DIRECCIÓN Y COMPONENTES    STEERING PISTONS & PARTS    PISTONI IDRAULICI E COMPONENTI    VERIN ET COMPOSANTS DE DIRECTION

### PISTÓN DIRECCIÓN

### STEERING PISTON

### PISTONE STERZO

### VERIN DE DIRECTION

REF	OEM	
RM21745117	21745117 22256625 22452003	DPH-A, B, C, D, D1 DPR-A, B, C Instalación de gobierno electrónico Installation of electronic government Installazione del governo elettronico Installation de direction électronique

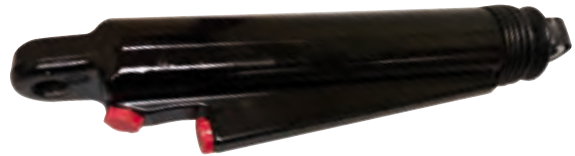

REF	OEM	
RM3858128	3812269 21910902 3862513 3862210 3860883 3860726	SX & DPS



REF	OEM	
REC22452005	22452005 21745119	DPH-A, B, C, D, D1 DPR-A, B, C, D DPI Instalación de gobierno simple Simple government installation Installazione semplice Installation simple



### ACTUADOR DE PISTÓN D4/D6

### PISTON ACTUATOR D4/D6

### ATTUATORE PISTONE D4/D6

### ACTIONNEUR D4/D6

REF	OEM	
REC22663814	22663814 21146097 21505553	DPH DPR



### KIT LATIGUILLOS DIRECCIÓN

### HYDRAULIC HOSES KIT

### KIT TUBI STERZO

### KIT FLEXIBLES HYDRAULIQUE

REF	OEM	
RM21548739	21548739 3863347 3863405 3863406 3863407	DPH, DPR, DPI



**KIT REPARACIÓN PISTÓN**

**PISTON REPAIR KIT**

**KIT RIPARAZIONE PISTONE**

**KIT REPARATION DE VERIN**

REF	CILINDRO CYLINDER CILINDRO VERIN DE DIRECTION
REC22170	REC22452005



REF	CILINDRO CYLINDER CILINDRO VERIN DE DIRECTION
REC22171	3861556



**KIT FUELLES PISTONES DIRECCION**

**KIT BELLOWS STEERING PISTON**

**KIT CUFFIE PISTONE STERZO**

**KIT SOUFFLETS POUR VERIN DE DIRECTION**

REF	OEM	
RM21132674	21132674	DPH-A, B, C DPR-A, B, C DPI



**BOMBA HIDRÁULICA DIRECCION**

**HYDRAULIC STEERING PUMP**

**POMPA IDRAULICA STERZO**

**POMPE DE DIRECTION HYDRAULIQUE**

REF	OEM	
RM3888323	3888323 3850491 3850492	3.0 GLP-E



**EXTRACTOR POLEA BOMBA DIRECCION**

**PULLEY REMOVER, DRIVE PUMP**

**RIMOZIONE PULEGGIA, POMPA STERZO**

**EXTRACTEUR DE POULIE POMPE DE DIRECTION**

new

REF
REC91-25034



**SERVO BOMBA**

**SERVO PUMP**

**SERVO POMPA**

**SERVO POMPE**

REF	OEM	
REC3887373	3887373	3.0 V6, V8 Nueva versión New version Nuova versione Nouvelle version



REF	OEM	
REC3884974	3884974 3860871	V6 GI, GL, GXI V8 GI, GL, GXI



**POLEA PARA SERVO BOMBA**

**PULLEY FOR SERVO PUMP**

**PULEGGIA PER SERVO POMPA**

**POULIE DE SERVO POMPE**

REF	OEM	SERVO BOMBA SERVO PUMP SERVO POMPA SERVO POMPE
REC3853804	3853804	RM3888323

Correa dentada  
Toothed belt  
Cinghia dentata  
Courroie dentée



REF	OEM	
REC1359649	1359649 22297931 22797782	KAD42, 43, 44, 300, 32 D3, D4, D6 MD, TMD, TAMD22 (trans. SX) 7.4/8.2 L GS, GL, GI

Se suministra con polea para correa trapezoidal. Para serie D utilizad polea antigüa.  
Supplied with V-belt pulley. For D series use old pulley.  
Fornito con puleggia a cinghia trapezoidale. Per la serie D utilizzare la vecchia puleggia.  
Fourni avec une poulie à courroie en V. Pour la série D, utilisez l'ancienne poulie.



new

**CABLE RUDDER**

**RUDDER CABLE**

**CAVO RUDDER**

**CÂBLE D'EMBASE**

REF	OEM	
REC3593951	3593951	DPH DPR DPI



**CABLE CONTROL 33C**

**CONTROL CABLES 33C**

**CAVI DI CONTROLLO 33C**

**CÂBLES DE COMMANDE 33C**

REF	OEM	(ft)	(m)
PRE3300C05	21633476	5	1.52
PRE3300C06	21633477	6	1.83
PRE3300C07	21633478	7	2.13
PRE3300C08	21633479	8	2.44
PRE3300C09	21633480	9	2.74
PRE3300C10	21633481	10	3.05
PRE3300C11	21633482	11	3.35
PRE3300C12	21633483	12	3.66
PRE3300C13	21633484	13	3.96
PRE3300C14	21633485	14	4.27
PRE3300C15	21633486	15	4.57
PRE3300C16	21633487	16	4.88
PRE3300C17	21633488	17	5.18
PRE3300C18	21633489	18	5.49
PRE3300C19	21633490	19	5.79
PRE3300C20	21633491	20	6.10
PRE3300C21	21633492	21	6.40
PRE3300C22	21633493	22	6.71
PRE3300C23	21633494	23	7.01
PRE3300C24	21633495	24	7.32

REF	OEM	(ft)	(m)
PRE3300C25	21633496	25	7.62
PRE3300C26	21633497	26	7.92
PRE3300C27	21633498	27	8.23
PRE3300C28	21633499	28	8.53
PRE3300C29	21633500	29	8.84
PRE3300C30	21633501	30	9.14
PRE3300C31	21633502	31	9.45
PRE3300C32	21633503	32	9.75
PRE3300C33	21633504	33	10.06
PRE3300C34	21633505	34	10.36
PRE3300C35	21633506	35	10.67
PRE3300C36	21633507	36	10.97
PRE3300C38	21633509	38	11.58
PRE3300C40	21633511	40	12.19
PRE3300C42	21633513	42	12.80
PRE3300C44	21633515	44	13.41
PRE3300C46	21633517	46	14.02
PRE3300C48	21633519	48	14.63
PRE3300C50	21633521	50	15.24

VOLVO

RECAMBIOS MARINOS

MODELOS DE COLAS

STERNDRIVE MODELS

MODELLI PIEDI

MODÈLES D'EMBASES

VOLVO

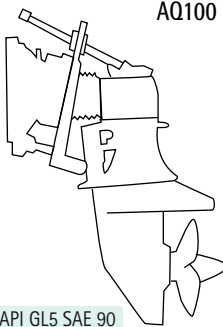
**AQ100**  
  
 API GL5 SAE 90  
 REC80W90

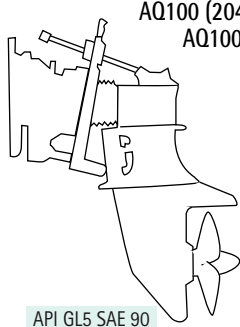
**AQ100 (20422-45350)  
 AQ100B (500000)**  
  
 API GL5 SAE 90  
 REC80W90

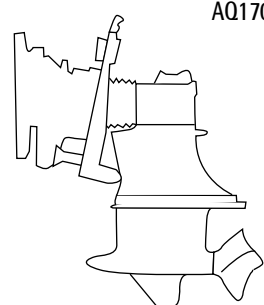
**AQ170R**  
  
 SAE: SAME AS ENGINE

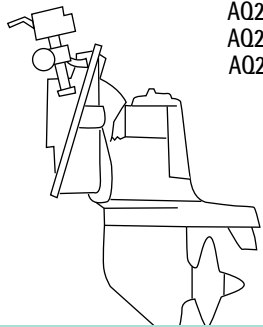
**AQ200  
 AQ250  
 AQ270**  
  
 SAE: SAME AS ENGINE

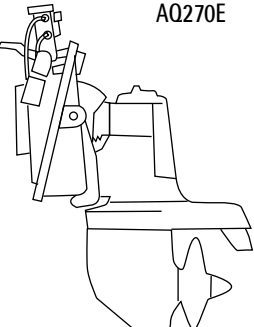
**AQ270E**  
  
 SAE: SAME AS ENGINE

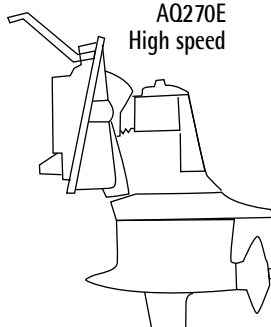
**AQ270E  
 High speed**  
  
 SAE: SAME AS ENGINE

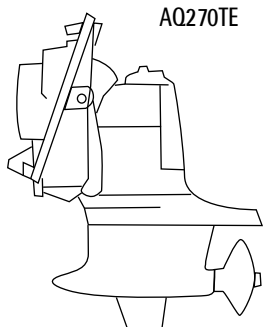
**AQ270TE**  
  
 SAE: SAME AS ENGINE

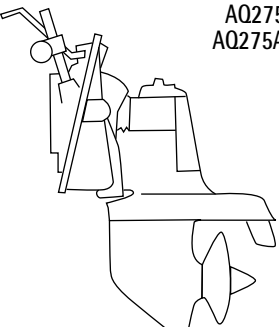
**AQ275  
 AQ275A**  
  
 SAE: SAME AS ENGINE

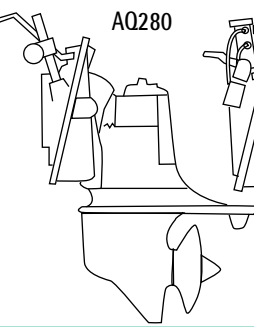
**AQ280**  
  
 SAE: SAME AS ENGINE

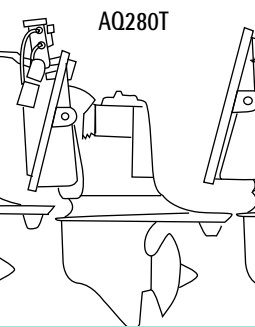
**AQ280T**  
  
 SAE: SAME AS ENGINE

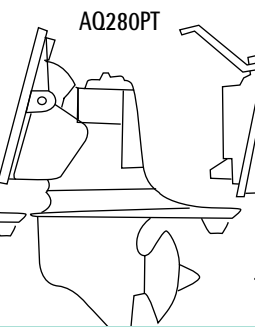
**AQ280PT**  
  
 SAE: SAME AS ENGINE

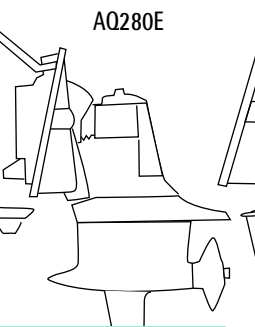
**AQ280E**  
  
 SAE: SAME AS ENGINE

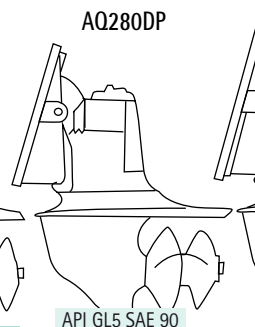
**AQ280DP**  
  
 API GL5 SAE 90  
 REC80W90

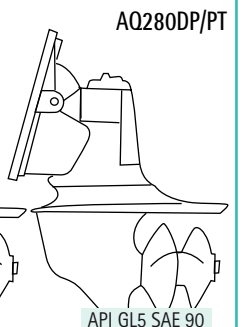
**AQ280DP/PT**  
  
 API GL5 SAE 90  
 REC80W90

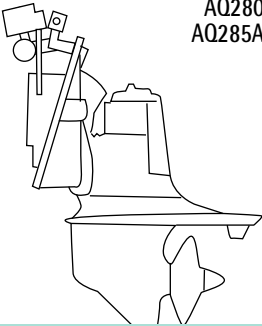
**AQ280  
 AQ285A**  
  
 SAE: SAME AS ENGINE

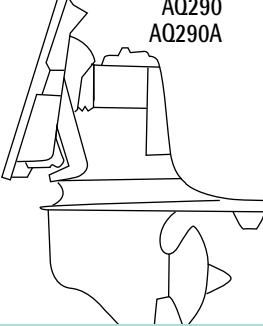
**AQ290  
 AQ290A**  
  
 SAE: SAME AS ENGINE

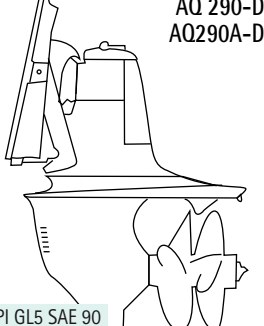
**AQ 290-DP  
 AQ290A-DP**  
  
 API GL5 SAE 90  
 REC80W90

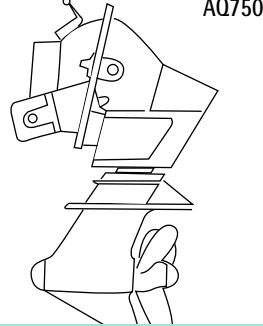
**AQ750**  
  
 SAE: SAME AS ENGINE

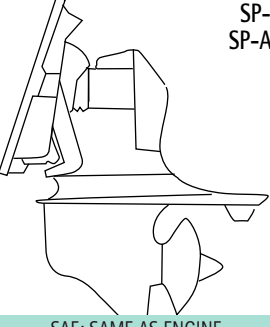
**SP-A  
 SP-A1**  
  
 SAE: SAME AS ENGINE

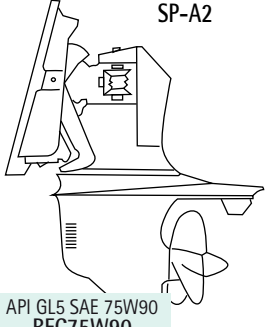
**SP-A2**  
  
 API GL5 SAE 75W90  
 REC75W90

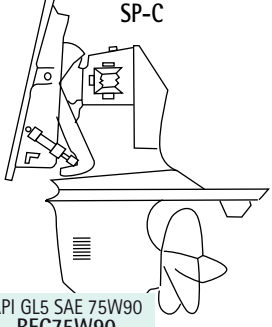
**SP-C**  
  
 API GL5 SAE 75W90  
 REC75W90

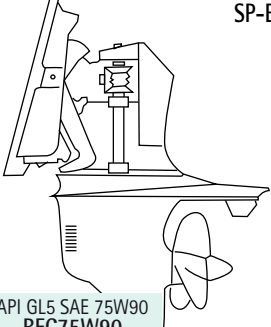
**SP-E**  
  
 API GL5 SAE 75W90  
 REC75W90

RECAMBIOS  
 MARINOS





 <b>DP-A</b> API GL5 SAE 75W90 REC80W90	 <b>DP-A1</b> API GL5 SAE 75W90 REC80W90	 <b>DP-A2</b> API GL5 SAE 75W90 REC75W90	 <b>DP-B DP-B1</b> API GL5 SAE 75W90 REC75W90	 <b>DP-C</b> API GL5 SAE 75W90 REC75W90
 <b>DP-C1 DP-D1</b> API GL5 SAE 75W90 REC75W90	 <b>DP-D DP-E</b> API GL5 SAE 75W90 REC75W90	 <b>DP-G</b> API GL5 SAE 75W90 REC75W90	 <b>DP-SM DP-SMTD DP-SMTD1</b> API GL5 SAE 75W90 REC75W90	 <b>DP-S DP-S1</b> API GL5 SAE 75W90 REC75W90

 <b>DPX-S DPX-S1 DPX-R</b> API GL5 SAE 75W90 REC75W90	 <b>DPX-A</b> API GL5 SAE 75W90 REC75W90	 <b>DPS-A</b> API GL5 SAE 75W90 REC75W90	 <b>XDP-B</b> API GL5 SAE 75W90 REC75W90
--	---	---	---

 <b>DPH-A</b> API GL5 SAE 75W90 REC75W90	 <b>DPR-A</b> API GL5 SAE 75W90 REC75W90	 <b>SX-A</b> API GL5 SAE 75W90 REC75W90	 <b>SX-S</b> API GL5 SAE 75W90 REC75W90
---	---	--	--

 <b>SX-C SX-C1 SX-C2</b> API GL5 SAE 75W90 REC75W90	 <b>SX-RT1 SX-RT2</b> API GL5 SAE 75W90 REC75W90	 <b>SX-M SX-MTD</b> API GL5 SAE 75W90 REC75W90
--	---	---

IPS-A, B, C, D, E, F

8



REF

REC3812357

9



REF

REC22256171

10



REF

REC23172849 Zn  
REC23172849AL Al

REF

OEM

REC22479648 22479648

REF

OEM

REC75W90U3  
REC75W140U3

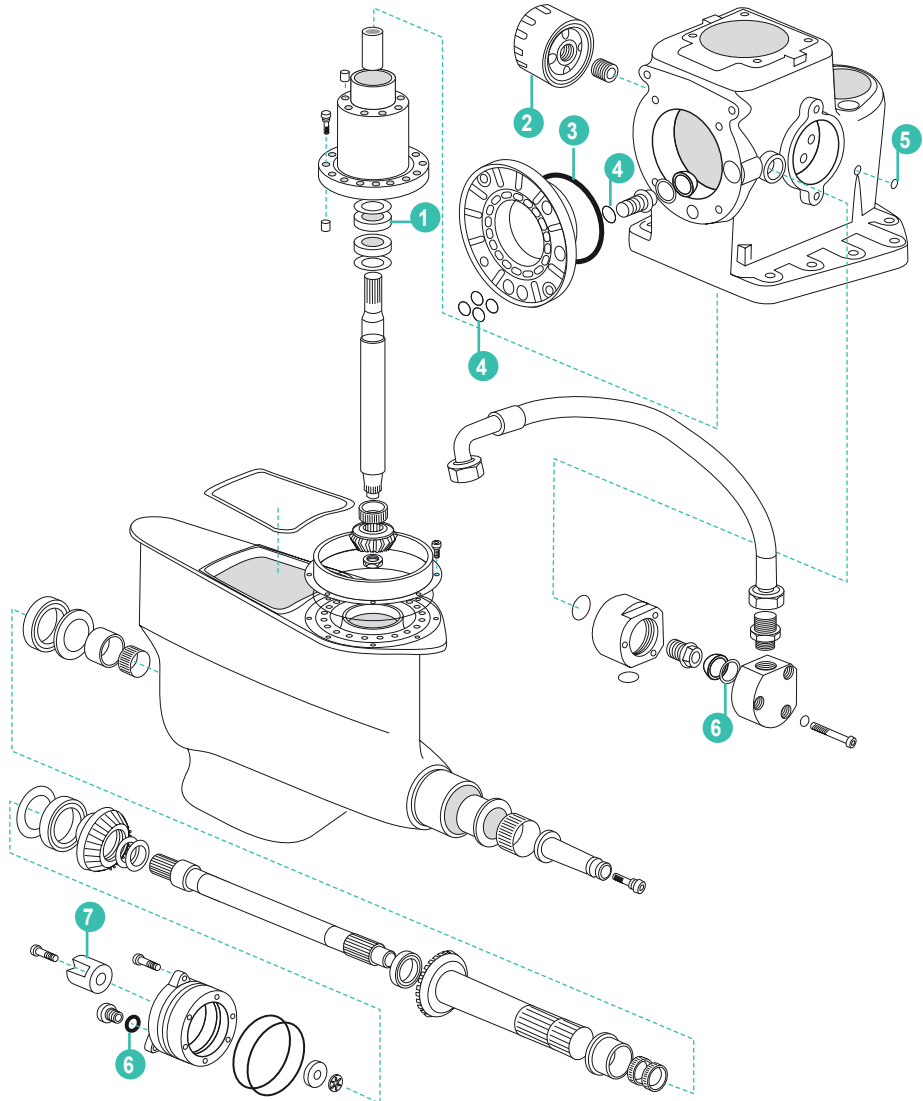

	REF	OEM				
1	REC3850852	3850852	COJINETE	BEARING	CUSCINETTO	ROULEMENT
2	REC834337	834337	FILTRO DE ACEITE	OIL FILTER	FILTRO OLIO	FILTRE A HUILE
3	REC925260	925260	ARO TÓRICO	O-RING	O-RING	JOINT TORIQUE
4	REC955989	955989	ARO TÓRICO	O-RING	O-RING	JOINT TORIQUE
5	REC976018	976018	ARO TÓRICO	O-RING	O-RING	JOINT TORIQUE
6	REC949656	949656	ARO TÓRICO	O-RING	O-RING	JOINT TORIQUE
7	CM3593881	3593981	ÁNODO	ANODE	ANODO	ANODE
8	REC3812357	3812357	KIT JUNTAS	GASKET KIT	KIT GUARNIZIONI	KIT JOINTS
9	REC22256171	22256171	ARO DE GOMA	RUBBER RING	ANELLO IN GOMMA	JOINT CAOUTCHOUC
10	REC23172849 REC23172849AL	40005875 23172849	ÁNODO	ANODE	ANODO	ANODE

DESPIECE COLA DE VELEROS

SAILBOAT GEARCASE COMPONENTS

ESPLOSO PIEDE VELA

PIÈCES DE SAIL DRIVE

120, 130, 150, M525

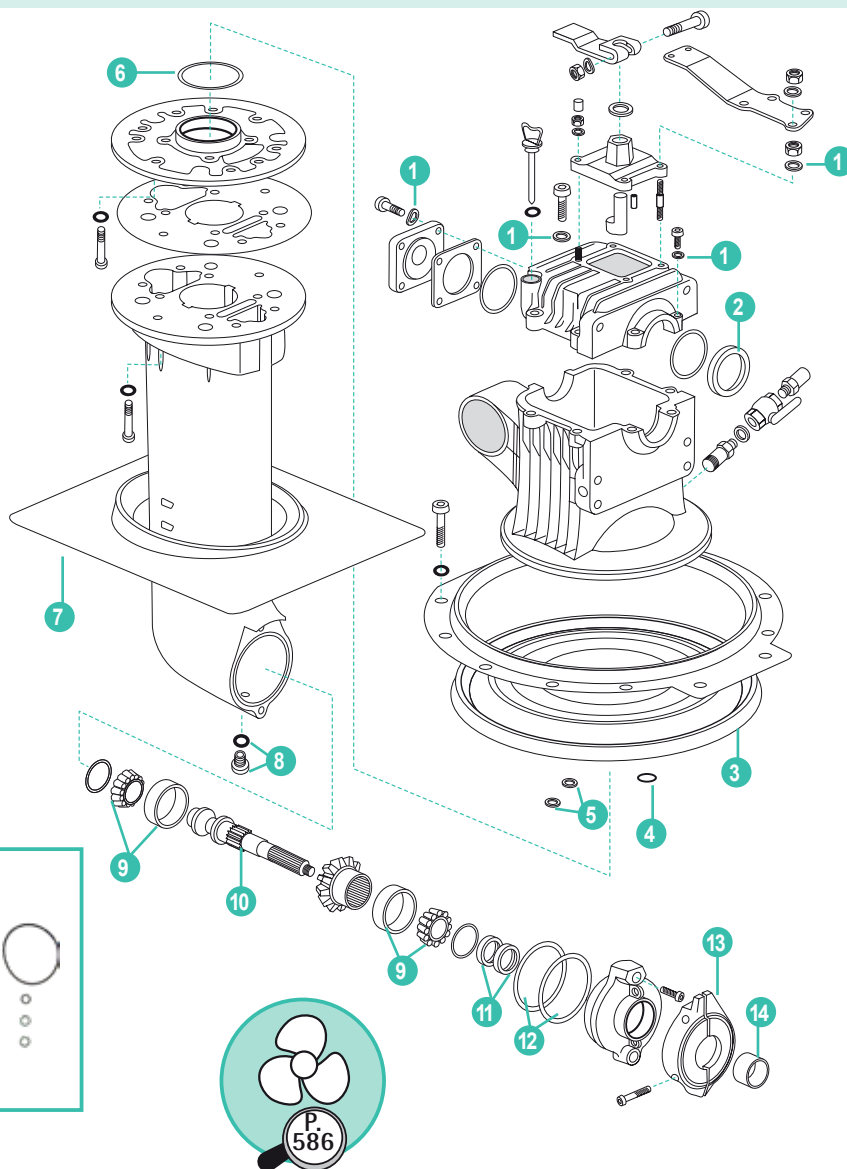

	REF	OEM				
1	REC941907	941907	ARANDELA	WASHER	RONDELLA	RONDELLE
2	REC3583322	3583322	RETÉN	SEAL	TENUTA	JOINT SPI
3	REC877362	21389074	KIT REPARACION GOMA	GOMMA REPAIR KIT	KIT RIPARAZIONE GOMMA	KIT SOUFFLET
4	REC955974	955974	ARO TÓRICO	O-RING	FASCIA TONDA	JOINT TORIQUE
5	REC925054	925054	ANILLO RETÉN	OIL SEAL	PARAOLIO	JOINT SPI
6	REC925256	925256	ARO TÓRICO	O-RIN	FASCIA TONDA	JOINT TORIQUE
7	REC22303438 CEF501001	22303438	GOMA PASACASCOS COLA	BELLOW KIT	GOMMA PASSASCAFO PIEDE	BAVETTE CAOUTCHOUC
8	REC22-67892A05	3854539	TAPÓN	CAP	TAPPO	BOUCHON
9	REC31-66668A1	3854249	COJINETE RODILLO (150)	BEARING (150)	CUSCINETTO (150)	ROULEMENT (150)
10	REC3582888	3582888	ÁRBOL TRANSMISIÓN (150)	SHAFT SAILBOAT (150)	ALBERO (150)	ARBRE D'HELICE (150)
11	REC3593663	3593663	RETÉN	O-RING	TENUTA	JOINT SPI
12	REC889672	889672	ARO TÓRICO (120 y 130)	O-RING (120 & 130)	TENUTA (120 E 130)	JOINT TORIQUE (120 E 130)
	REC925256	925256	ARO TÓRICO (M525)	O-RING (M525)	TENUTA (M525)	JOINT TORIQUE (M525)
	REC876286AL	876286	KIT ÁNODO AI (110, 120)	KIT AI ANODE (110, 120)	KIT ANODO AI (110, 120)	KIT ANODES AI (110, 120)
	REC22651246	3888305	KIT ÁNODO Zn(130, 150)	KIT Zn ANODE (130, 150)	KIT ANODO Zn (130, 150)	KIT ANODES Zn (130, 150)
	REC22651246AL	3888305	KIT ÁNODO AI (130, 150)	KIT AI ANODE (130, 150)	KIT ANODO AI (130, 150)	KIT ANODES AI (130, 150)
14	REC3582887	3582887	DISTANCIADOR EJE COLAS	SPACER SHAFT	DISTANZIATORE DELL'ASSE	ENTRETOISE
			KIT	KIT	KIT	KIT SOUFFLETS
15	REC877362	21389074	110S, S-B, 120S,S-E, S-D, S120C, 130S/R, 150S/R, M525S/SR	110S, S-B, 120S,S-E, S-D, S120C, 130S/R, 150S/R, M525S/SR	110S, S-B, 120S,S-E, S-D, S120C, 130S/R, 150S/R, M525S/SR	110S, S-B, 120S,S-E, S-D, S120C, 130S/R, 150S/R, M525S/SR
16	REC876391	876391 875720	KIT 120SB, S120C, S-E, S-D	KIT 120SB, S120C, S-E, S-D	KIT 120SB, S120C, S-E, S-D	KIT JOINTS 120SB, S120C, S-E, S-D
17	REC21112496	21112496	KIT 120	KIT 120	KIT 120	KIT JOINTS 120
	REC21112497	21112497	KIT 130/150	KIT 130/150	KIT 130/150	KIT JOINTS 130/150

VOLVO

RECAMBIOS MARINOS

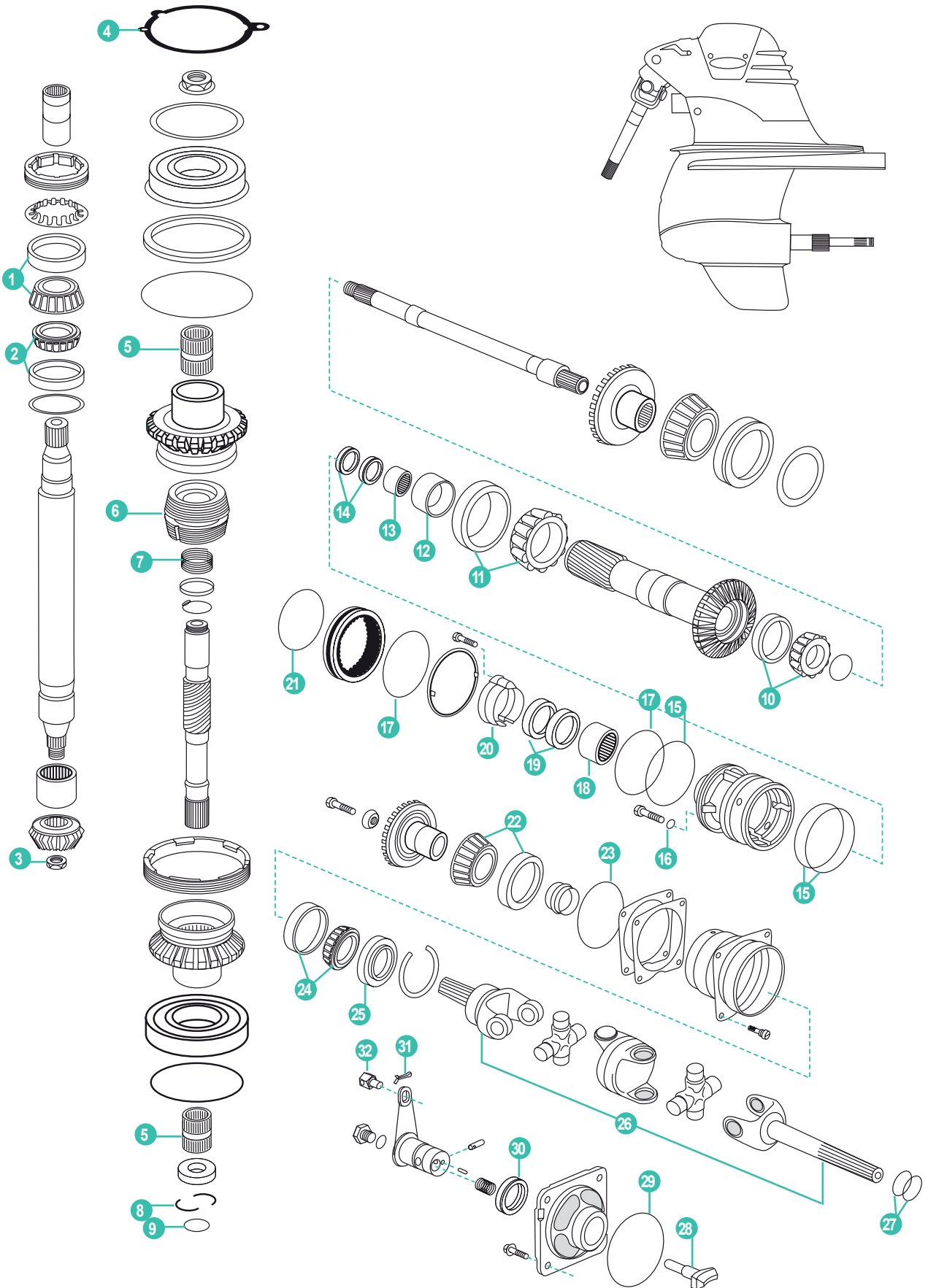



	REF	OEM				
1	REC31-86748A1	6854250	COJINETE RODILLO	BEARING	CUSCINETTO	ROULEMENT
2	REC31-66668A1	3854249	COJINETE RODILLO	BEARING	CUSCINETTO	ROULEMENT
3	REC852212	852212	TUERCA	NUT	DADO	ÉCROU
4	REC3862105	3862105	JUNTA TAPA	COVER SEAL	GUARNIZIONE COPPERCHIO	JOINT DE COUVERCLE
5	RM3852390	3852390	COJINETE	BEARING	CUSCINETTO	ROULEMENT
6	RM3807613	3807613	MANGUITO DESLIZANTE	SLIDING SLEEVE	CONO SELETTORE	CONE D'EMBRAYAGE
7	REC3852296	3852296	RESORTE	SPRING	MOLLA	RESSORT
8	REC3852295	3852295	CLIP	CLIP	CLIP	CLIP
9	REC949656	949656	ARO TÓRICO	O-RING	O-RING	JOINT TORIQUE
10	RM184691	184691	COJINETE	BEARING	CUSCINETTO	ROULEMENT
11	REC184765	184765	COJINETE	BEARING	CUSCINETTO	ROULEMENT
12	REC184683	184683	ANILLO INTERIOR	RING	ANELLO INTERIORE	BAGUE INTÉRIEURE
13	REC183272	183272	COJINETE	BEARING	CUSCINETTO	ROULEMENT
14	REC853808	853808	RETÉN	SEAL	PARAOLIO	JOINT SPI
15	REC942791	942791	ARO TÓRICO	O-RING	O-RING	JOINT TORIQUE
16	REC955981	955981	ARO TÓRICO	O-RING	O-RING	JOINT TORIQUE
17	REC946438	946438	ARO TÓRICO	O-RING	O-RING	JOINT TORIQUE
18	REC183859	183859	COJINETE DE RODILLO	BEARING	CUSCINETTO	ROULEMENT A AIGUILLES
19	REC851407	851407	RETÉN	O-RING	O-RING	JOINT SPI
20	CM3861634	3861634	ÁNODO Zn	Zn ANODE	ANODO Zn	ANODE Zn
	CM3861634A	3861634	ÁNODO AI	AI ANODE	ANODO AI	ANODE AI
21	REC3852865	3852865	ARO TÓRICO	O-RING	O-RING	JOINT TORIQUE
22	REC3850852	3850852	COJINETE	BEARING	CUSCINETTO	ROULEMENT
23	REC967344	967344	ARO TÓRICO	O-RING	O-RING	JOINT TORIQUE
24	REC183247	3850853	COJINETE	BEARING	CUSCINETTO	ROULEMENT
25	REC3852272	3852272	RETÉN	SEAL	PARAOLIO	JOINT SPI
26	RM3860842	3860842	TRANSMISIÓN COMPLETA	U-JOINT ASSEMBLY	KIT CARDANO	CARDAN COMPLET
27	REC997368	3852565	ARO TÓRICO	O-RING	O-RING	JOINT TORIQUE
28	RM3856502	3856502	PUNTERA SELECTOR	GEAR DOG	PERNO	DOIGT DE SELECTEUR
29	REC925093	925093	ARO TÓRICO	O-RING	O-RING	JOINT TORIQUE
30	REC853868	853868	RETÉN	SEALING RING	O-RING TENUTA	JOINT SPI
31	REC3854480	3854480	PASADOR HENDIDO	PIN	SPINOTTO	GOUPILLE DE SECURITE
32	REC22336734	3852329	CUBO	HUB	CUBE	CONNECTEUR CÂBLE DE COMMANDE



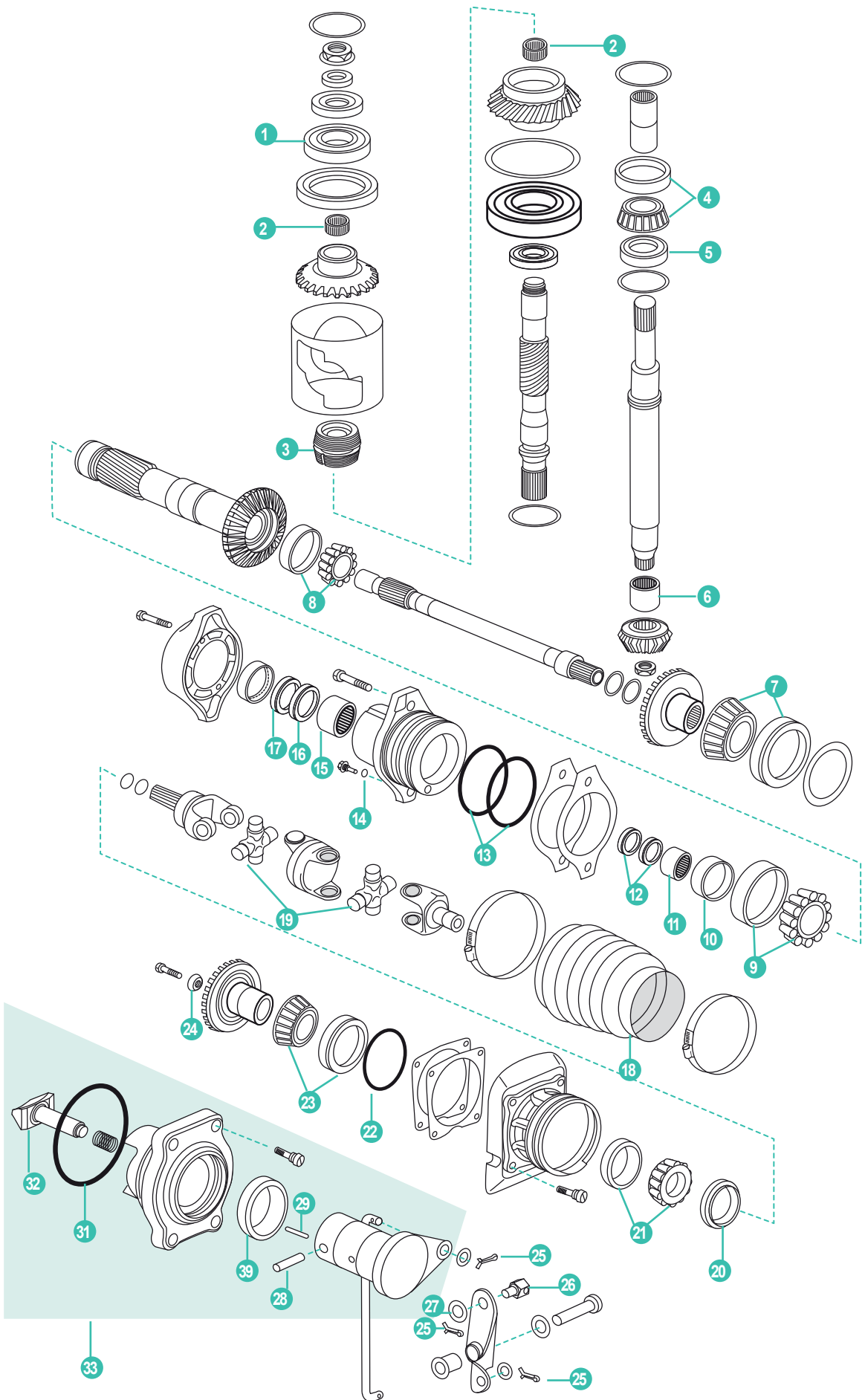

	REF	OEM				
1	REC181804	181804	COJINETE BOLAS	BEARING	CUSCINETTO	ROULEMENT
2	REC184778	184778	COJINETE DE RODILLO	BEARING	CUSCINETTO	ROULEMENT
3	REC3849006	3849006	MANGUITO DESLIZANTE	SLIDING SLEEVE	CONO SELETTORE	CONE D'EMBRAYAGE
4	REC11065	11065	COJINETE DE RODILLO	BEARING	CUSCINETTO	ROULEMENT
5	REC984223	984223	COJINETE DE BOLAS	BEARING	CUSCINETTO	ROULEMENT
6	REC184654	184654	COJINETE	BEARING	CUSCINETTO	ROULEMENT
7	REC183765	183765	COJINETE DE RODILLO	BEARING	CUSCINETTO	ROULEMENT
8	REC425784	425784	COJINETE DE RODILLO	BEARING	CUSCINETTO	ROULEMENT
9	REC984222	984222	COJINETE DE RODILLO	BEARING	CUSCINETTO	ROULEMENT
10	REC984225	984225	CASQUILLO	BUSHING	BOCCOLA	BAGUE
11	REC183390	184642	COJINETE	BEARING	CUSCINETTO	ROULEMENT
12	REC3863080	3863080+3863081	KIT RETENES	SEALS KIT	KIT TENUTE	KIT JOINTS
13	REC925260	925260	ARO TÓRICO	O-RING	O-RING	JOINT TORIQUE
14	REC889455	889455	JUNTA TAPÓN ACEITE	GASKET OF OIL CAP	GUARNIZIONE TAPPO OLIO	JOINT SPI BOUCHON D'HUILE
15	REC984224	984224	COJINETE AGUJAS	BEARING	CUSCINETTO	ROULEMENT
16	REC3863083	3863083	RETÉN	SEAL RING	PARAOLIO	JOINT SPI
17	REC3863082	3863082	RETÉN	SEAL	TENUTA	JOINT SPI
18	REC3808898	3808898	FUELLE	BELLOW	CUFFIA	SOUFFLET DE CARDAN
19	REC3843136	3843136	CRUCETA	U-JOINT	CROCETTA	CROISSILLON DE CARDAN
20	REC3863084	3863084	RETÉN ACEITE	SEAL OIL	PARAOLIO	JOINT SPI
21	REC11043	11043	COJINETE	BEARING	CUSCINETTO	ROULEMENT
22	REC925259	925259	ARO TÓRICO	O-RING	O-RING	JOINT TORIQUE
23	REC11096	11096	COJINETE RODILLO	BEARING	CUSCINETTO	ROULEMENT
24	REC3862387	3862387	ARANDELA	WASHER	RONDELLA	RONDELLE
25	REC17276	17276	PASADOR HENDIDO	PIN	SPINOTTO	GOUPILLE
26	REC22336734	22336734	CUBO	HUB	CUBO	CONNECTEUR CABLE DE COMMANDE
27	REC940191	940191	ARANDELA	WASHER	RONDELLA	RONDELLE
28	REC3862867	3862867	PASADOR	PIN	SPINOTTO	GOUPILLE
29	REC951936	951936	PASADOR TUBULAR	PIN	SPINOTTO	GOUPILLE
30	REC3863085	3863085	RETÉN	SEAL RING	TENUTA	JOINT SPI
31	REC945624	945624	ARO TÓRICO	O-RING	O-RING	JOINT TORIQUE
32	REC3862387	3862387	PUNTERA SELECTOR	DOG	TERMINALE	DOIGT DE SELECTION
33	REC22273952	22273952 3862385	MECANISMO DEL CAMBIO	SHIFT MECHANISM	MECCANISMO DI CAMBIO	MÉCANISME DE CHANGEMENT

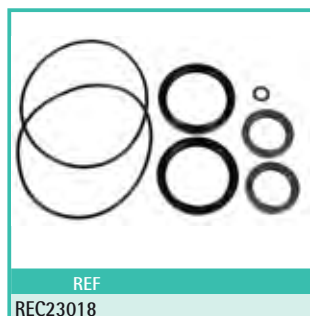

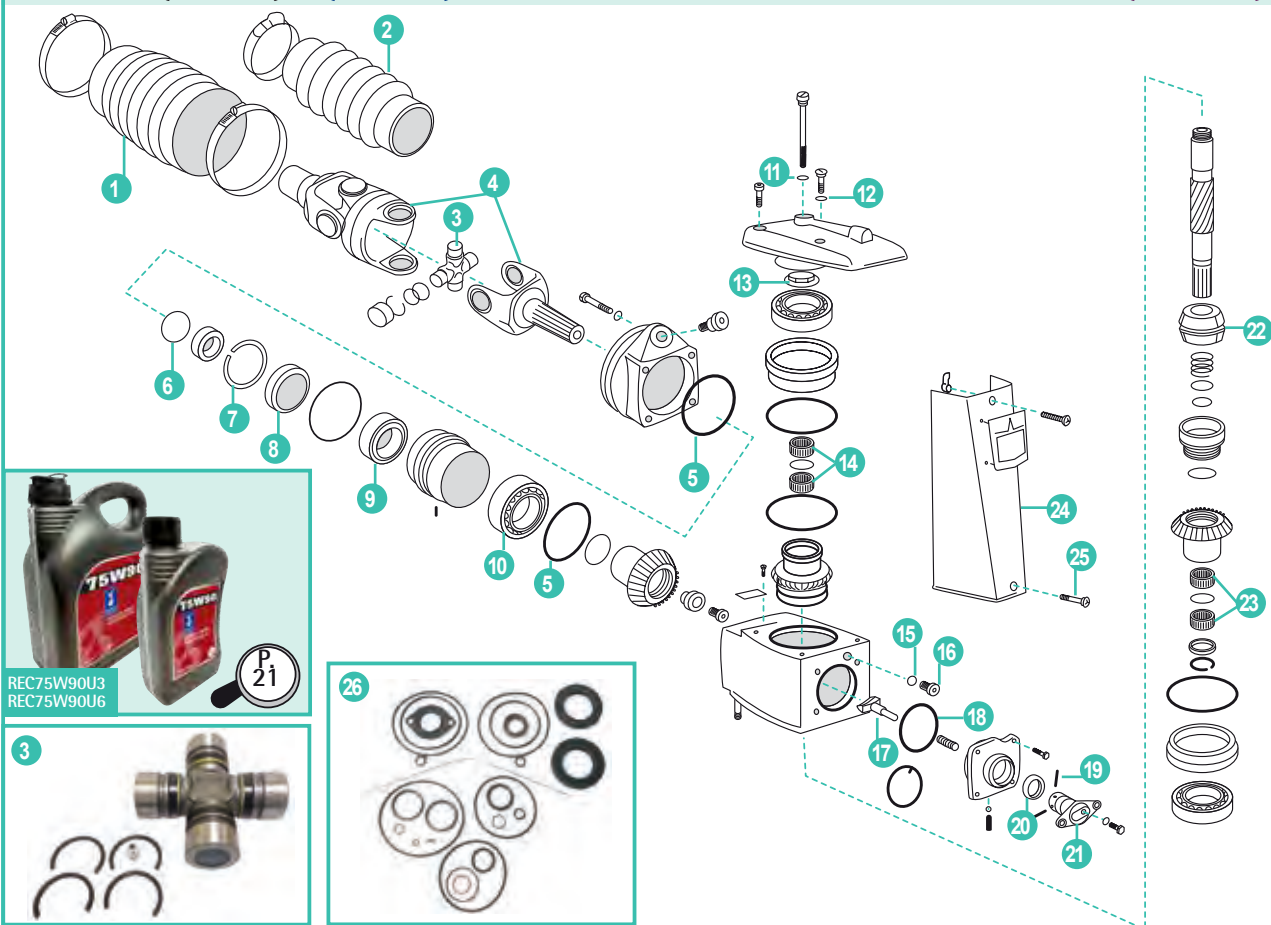
PARTE SUPERIOR  
AQUAMATIC (ANTIGUA)UPPER HOUSING  
(OLD TYPE)PARTE SUPERIORE  
AQUAMATIC (VECCHIO)PARTIE SUPÉRIEURE  
AQUAMATIC (ANCIENNE)

REF	OEM				
1	REC876294 876294	FUELLE CRUCETA	U-JOINT BELLOWS	MANICOTTO STAFFA DI POPPA	SOUFFLET DE CARDAN
2	REC876633 876633	FUELLE ESCAPE CON FLAP	EXHAUST BELLOWS WITH FLAPPERS	CUFFIA SCARICO CON VALVOLA	SOUFFLET D'ECHAPPEMENT A CLAPET
	REC876631 876631	FUELLE ESCAPE SIN FLAP	EXHAUST BELLOWS WITHOUT FLAPPERS	CUFFIA SCARICO SENZA VALVOLA	SOUFFLET D'ECHAP 200 - 290DP
3	REC75832T 853255	CRUCETA CARDAN	U-JOINT	CROCETTA CARDANO	CROISSILLON DE CARDAN
4	RM3860230 3860230	EJE CARDAN 27 ESTRÍAS	YOKE 27 SPLINE	ASSE CARDANO 27 DENTI	CARDAN 27 DENTS
5	REC925256 925256	ARO TÓRICO	O-RING FOR SEALING RING	O-RING	JOINT TORIQUE
6	REC832675 832675	ARO TÓRICO (280, 290, SP, DP)	SEALING RING (280, 290, SP, DP)	O-RING (280, 290, SP, DP)	JOINT TORIQUE (280, 290, SP, DP)
7	REC956000 956000	ARO TÓRICO	O-RING	O-RING	JOINT TORIQUE
8	REC839253 839253	RETÉN ACEITE (280, 290, SP, DP)	OIL SEAL FOR (280, 290, SP, DP)	PARAOLIO (280, 290, SP, DP)	JOINT SPI (280, 290 SP, DP)
	REC942615 942615	RETÉN ACEITE (200, 250, 270)	OIL SEAL FOR (200, 250, 270)	PARAOLIO (200, 250, 270)	JOINT SPI (200, 250, 270)
9	REC183247 183247	COJINETE	BEARING	CUSCINETTO	ROULEMENT
10	REC3850852 3850852	COJINETE	BEARING	CUSCINETTO	ROULEMENT
11	REC955974 955974	ARO VARILLA ACEITE	O-RING FOR DIPSTICK	O-RING ASTICELLA OLIO	JOINT TORIQUE
12	REC955989 955989	ARO TÓRICO	O-RING	O-RING	JOINT TORIQUE
13	REC832669 832669	JUNTA RETÉN TAPA	GASKET/SEAL FOR TOP COVER	GUARNIZIONE COPERCHIO	JOINT COUVERCLE
	REC853542 853542	COJINETE (70, 275, 280, 290, DP-A, DP-B)	BEARING (70, 275, 280, 290, DP-A, DP-B)	CUSCINETTO (70, 275, 280, 290, DP-A, DP-B)	ROULEMENT (70, 285, 280, 290, DP-A, DP-B)
14	REC3857176 3857176	COJINETE (SP-A1, A2, C, C1, DPA1, A2, B1, C, D, D1, E, G, DPX, S, S1, SX)	BEARING (SP-A1, A2, C, C1, DPA1, A2, B1, C, D, D1, E, G, DPX, S, S1, SX)	CUSCINETTO (SP-A1, A2, C, C1, DPA1, A2, B1, C, D, D1, E, G, DPX, S, S1, SX)	ROULEMENT (SP-A1, A2, C, C1, DPA1, A2, B1, C, D, D1, E, G, DPX, S, S1, SX)
15	REC897682 897682	JUNTA	GASKET	GUARNIZIONE	JOINT
16	RM981965 981965	TORNILLO TAPÓN	OIL PLUG	BULLONE TAPPO	BOUCHON
17	RM3856502 3856502	PUNTERA CONO SELECTOR	GEAR DOG	PUNTO CONO SELETTORE	DOIGT DE SELECTEUR
18	REC925093 925093	ARO TÓRICO	O-RING	O-RING	JOINT TORIQUE
19	REC951924 951924	PASADOR	PIN	SPINOTTO	GOUILLE
20	REC853868 853868	RETÉN ACEITE	OIL SEAL FOR SHIFT SHAFT	PARAOLIO	JOINT SPI
21	REC3856008 3856008	PISTÓN SELECTOR	SHIFT PLUNGER	PISTONE SELETTORE	SÉLECTEUR DE VITESSE
22	RM3807613 3807613	CONO SELECTOR	SLIDING SLEEVE	CONO SELETTORE	CONE D EMBRAYAGE
23	RM3852390 3852390	COJINETE	BEARING	CUSCINETTO	ROULEMENT
24	REC832570 832570	TAPA TRASERA	REAR COVER	COPERCHIO POSTERIORE	COUVERCLE ARRIÈRE
25	REC941816 941816	TORNILLO INFERIOR TAPA TRASERA	REAR COVER LOWER SCREW	VITE INFERIORE, COPERCHIO	VIS INFÉRIEUR COUVERCLE ARRIÈRE
26	REC876266 876266	KIT DE RETENES AQ200, 290, AQSP, AQDP	SEAL KIT (AQ200, 290, AQSP, AQDP)	KIT RIPARAZIONE (AQ200, 290, AQSP, AQDP)	KIT JOINTS (AQ200, 290, AQSP, AQDP)



**PARTE SUPERIOR  
AQUAMATIC (MODERNA)**

**UPPER HOUSING  
(NEW TYPE)**

**PARTE SUPERIORE  
AQUAMATIC (MODERNO)**

**PARTIE SUPÉRIEURE  
AQUAMATIC (MODERNE)**

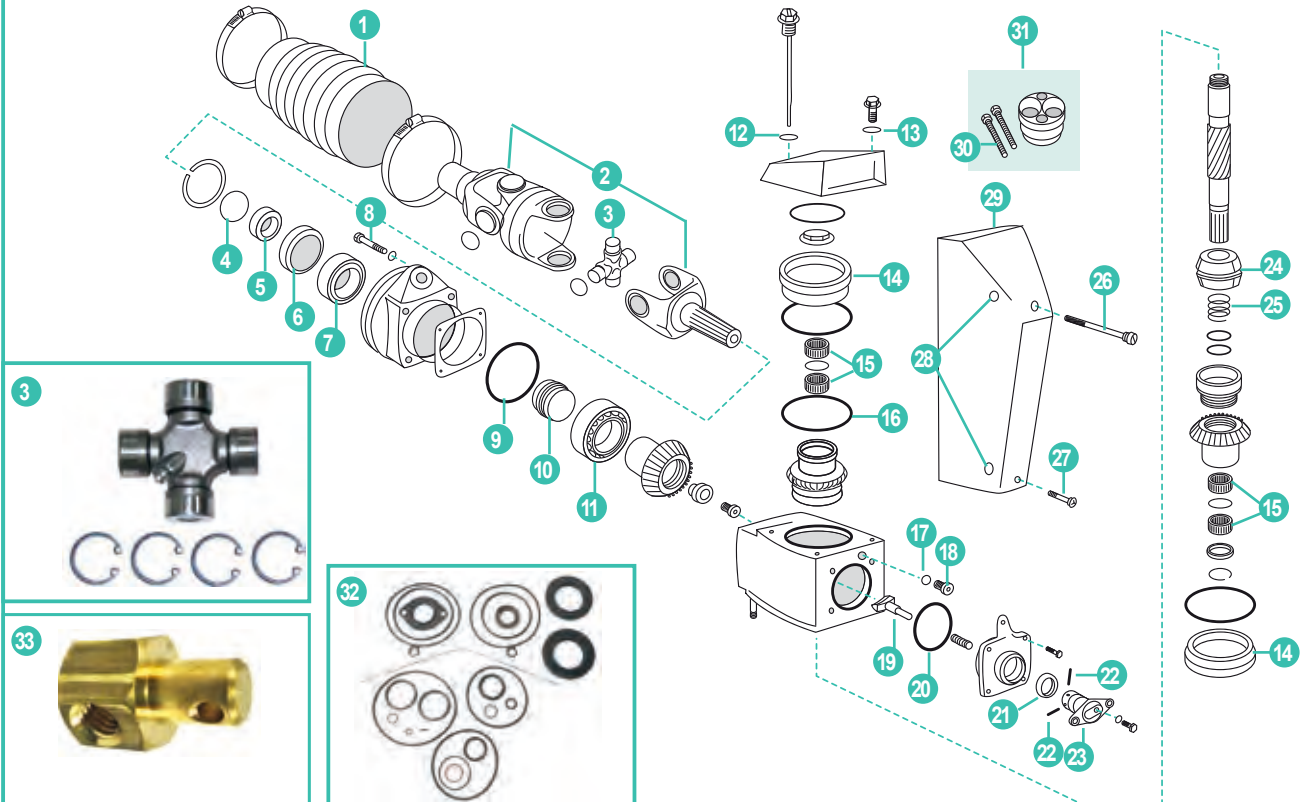

	REF	OEM				
1	REC876294	876294	FUELLE CRUCETA	U-JOINT BELLOWS	MANICOTTO STAFFA DI POPPA	SOUFFLET DE CARDAN
2	RM3860230	3860230	KIT TRANSMISION (290SP, DP)	GEAR UNIVERSAL JOINT (290SP, DP)	KIT TRASMISSIONE (290SP, DP)	CARDAN COMPLET (290SP, DP)
3	REC3860232	3860232	CRUCETA CARDAN (290)	GEAR SPIDER (290)	CROCETTA CARDANO (290)	CROISSILLON DE CARDAN (290)
4	REC956000	956000	ARO TÓRICO	O-RING	O-RING	JOINT TORIQUE
5	REC832675	832675	ARO TÓRICO	SEALING RING	O-RING	JOINT TORIQUE
6	REC839253	839253	RETÉN	SEALING RING	PARAOLIO	JOINT SPI
7	REC183247	183247	COJINETE	BEARING	CUSCINETTO	ROULEMENT
8	REC984068	984068	KIT 4 TORNILLOS (70 mm)	KIT 4 SCREWS (70 mm)	KIT 4 VITI (70 mm)	KIT 4 VIS (70 mm)
	REC956590	956590	KIT 4 TORNILLOS (63 mm)	KIT 4 SCREWS (63 mm)	KIT 4 VITI (63 mm)	KIT 4 VIS (63 mm)
9	REC967344	967344	ARO TÓRICO	O-RING	O-RING	JOINT TORIQUE
10	REC853484	853484	CASQUILLO	BUSHING	BOCCOLA	BAGUE
11	REC3850852	3850852	COJINETE	BEARING	CUSCINETTO	ROULEMENT
12	REC955989	955989	ARO TÓRICO	O-RING	O-RING	JOINT TORIQUE
13	REC955974	955974	ARO VARILLA ACEITE	O-RING FOR DIPSTICK	O-RING ASTICELLA OLIO	JOINT DE VIDANGE
14	REC3857176	3857176	COJINETE	BEARING	CUSCINETTO	ROULEMENT
15	RM3852390	3852390	COJINETE	BEARING	CUSCINETTO	ROULEMENT
16	REC832669	832669	JUNTA	GASKET	GUARNIZIONE	JOINT
17	REC897682	897682	JUNTA	GASKET	GUARNIZIONE	JOINT
18	RM981965	981965	TAPÓN	CAP	TAPPO	BOUCHON
19	RM3856502	3856502	PUNTERA CONO SELECTOR	GEAR DOG	PUNTO CONO SELETORE	DOIGT DE SELECTEUR
20	REC925093	925093	ARO TÓRICO	O-RING	O-RING	JOINT TORIQUE
21	REC853868	853868	RETÉN	SEALING RING	PARAOLIO	JOINT SPI
22	REC951924	951924	PASADOR LEVA SELECTOR	PIN CAM SELECTOR	SPINOTTO CAMME SELETORE	GOUPILLE ARBRE
23	REC3856008	3856008	PISTON SELECTOR	SHIFT PLUNGER	PISTONE SELETORE	SÉLECTEUR DE VITESSE
24	RM3807613	3807613	CONO SELECTOR	GEAR SLIDING SLEEVE	CONO SELETORE	CONE D EMBRAYAGE
25	REC3852296	3852296	RESORTE	SPRING	MOLLA	RESSORT
26	RM872027	872027	TORNILLO	SCREW	VITE	VIS
27	RM854661	854661	TORNILLO	SCREW	VITE	VIS
28	REC925052	905052	TÓRICA	O-RING	O-RING	JOINT TORIQUE
29	RM3857148	3857148	COVER	COVER	COPERCHIO	COUVERCLE
30	REC941807	941807	TORNILLO HORQUILLA	SCREW	VITE	VIS
31	REC852705	852705	DADO DIRECCION	PIVOT PIN	DADO	PIVOT
32	REC876266	876266	KIT DE RETENES (AQ200, 290, AQSP/DP)	SEAL KIT (AQ200, 290, AQSP/DP)	KIT RIPARAZIONE (AQ200, 290, AQSP/DP)	KITS JOINTS D'EMBASE (AQ200, 290, AQSP/DP)
33	REC22336734	22336734	CUBO	HUB	CUBO	CONNECTEUR CÂBLE DE COMMANDE

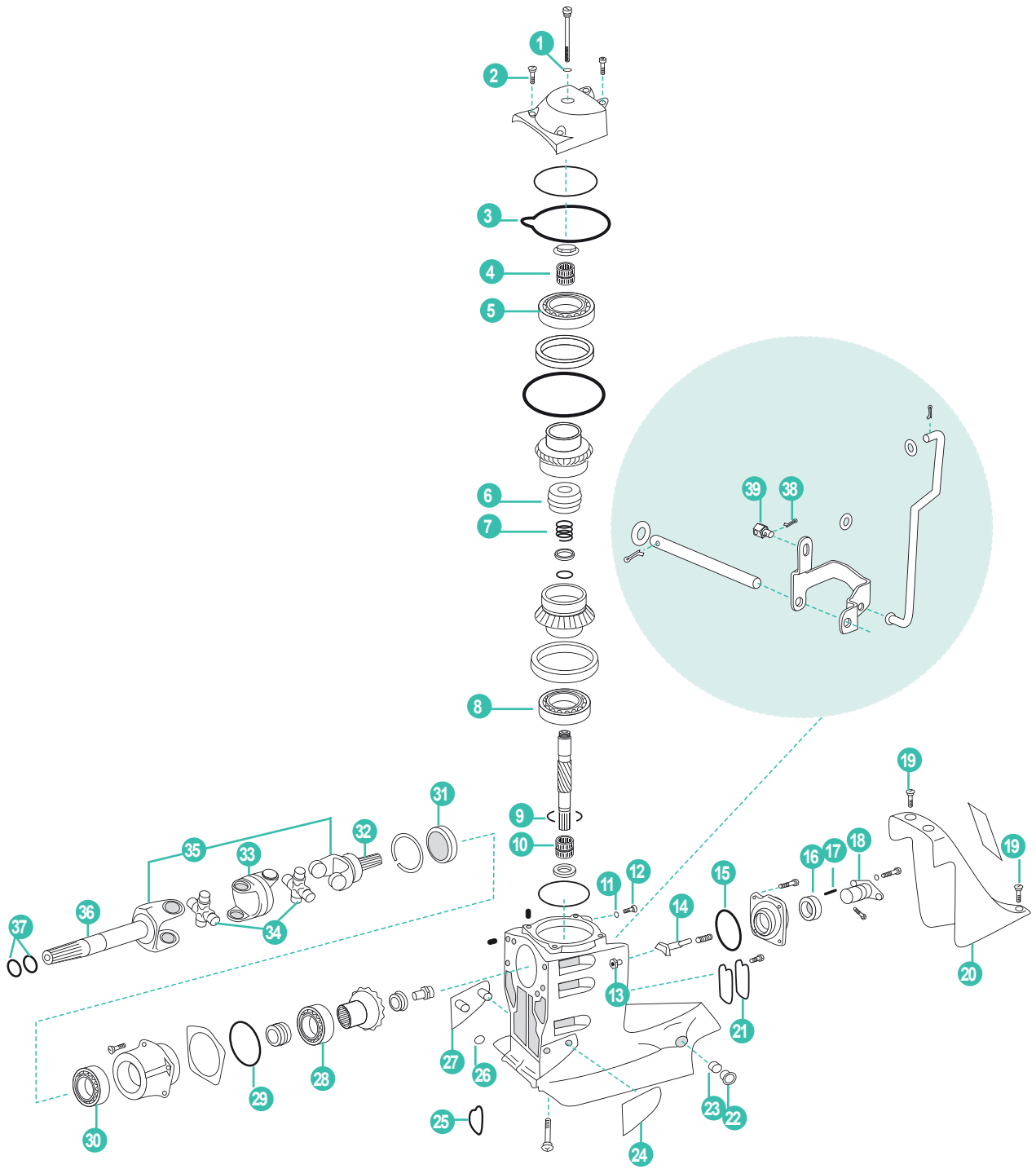

REF	OEM				
1 REC3852045	3852045	ARO TÓRICO	O-RING	O-RING	JOINT TORIQUE
2 REC3852454	3852454	TORNILLO	SCREW	VITE	VIS
3 REC3852317	3852317	JUNTA	GASKET	GUARNIZIONE	JOINT
4 RM3852390	3852390	COJINETE	BEARING	CUSCINETTO	ROULEMENT
5 REC3857176	3857176	COJINETE	BEARING	CUSCINETTO	ROULEMENT
6 RM3807613	3807613	CONO SELECTOR	SLIDING SLEEVE	CONO SELETTORE	CONE D EMBRAYAGE
7 REC3852296	3852296	RESORTE	SPRING	MOLLA	RESSORT
8 REC3857176	3856176	COJINETE	BEARING	CUSCINETTO	ROULEMENT
9 REC3852295	3852295	CIRCLIP	CIRCLIP	CLIP	CLIP
10 RM3852390	3852390	COJINETE	BEARING	CUSCINETTO	ROULEMENT
11 REC3855081	3855081	JUNTA	GASKET	GUARNIZIONE	JOINT
12 REC22-67892A05	3854539	TAPÓN	CAP	TAPPO	BOUCHON
13 REC11-859135	3852648	TUERCA	NUT	DADO	ÉCROU
14 RM3856502	3856502	PUNTERA SELECTOR	DOG	PUNTO CONO SELETTORE	DOIGT DE SELECTEUR
15 REC925093	925093	ARO TÓRICO	O-RING	O-RING	JOINT TORIQUE
16 REC853868	853868	RETÉN	OIL SEAL	PARAOLIO	JOINT SPI
17 REC951924	951924	PASADOR LEVA SELECTOR	CLAMPING PIN	PASADOR LEVA SELETTORE	CLAVETTE DU SELECTEUR
18 REC3856008	3856008	PISTON SELECTOR	SHIFT PLUNGER	PISTONE SELETTORE	SÉLECTEUR DE VITESSE
19 REC3852568	3852568	TORNILLO	SCREW	VITE	VIS
20 RM3852418	3852418	TAPA	COVER	COPERCHIO	COUVERCLE
21 REC3852279	3852279	JUNTA	GASKET	GUARNIZIONE	JOINT
22 REC3853423	3853423	CASQUILLO	BUSHING	BOCCOLA	BAGUE
23 RM3853424	3853424	ARO TÓRICO	O-RING	O-RING	JOINT TORIQUE
24 REC3589522	3589522	TAPA BABOR	PLATE	COPERCHIO SINISTRA	PLAQUE BABORD
25 REC3852560	3852560	RETÉN	OIL SEAL	PARAOLIO	JOINT SPI
26 RM3852516	3852516	RETENEDOR	RETAINER	TENUTA	RONDELLE FREIN
27 REC3589524	3589524	TAPA ESTRIBOR	PLATE	COPERCHIO DESTRA	PLAQUE TRIBORD
28 REC3850852	3850852	COJINETE	BEARING	CUSCINETTO	ROULEMENT
29 REC967344	967344	ARO TÓRICO	O-RING	O-RING	JOINT TORIQUE
30 REC183247	183247	COJINETE	BEARING	CUSCINETTO	ROULEMENT
31 REC3852272	3852272	RETÉN	OIL SEAL	PARAOLIO	JOINT SPI
32 REC3850814	3850814	EJE CORTO CARDAN	YOKE	ALBERINO CARDANO	FOURCHE DE CARDAN COURTE
33 REC393831	3850813	CARDAN	SOCKET	CARDANO	ROTULE
34 REC3850812	3850812	CRUCETA CARDAN	UNIVERSAL JOINT	CROCETTA CARDANO	CROISSILLON D'EMBASE
35 REC3860842	3860842	TRANSMISIÓN COMPLETA	U-JOINT ASSEMBLY	KIT CARDANO	CARDAN COMPLET
RM3860842	3860842	TRANSMISIÓN COMPLETA (XDP-B, DP-SM, SMTD3, DPS-A, B, SX-A, M, M1, MTD)	U-JOINT ASSEMBLY (XDP-B, DP-SM, SMTD3, DPS-A, B, SX-A, M, M1, MTD)	KIT CARDANO (XDP-B, DP-SM, SMTD3, DPS-A, B, SX-A, M, M1, MTD)	CARDAN (XDP-B, DP-SM, SMTD3, DPS-A, B, SX-A, M, M1, MTD)
36 REC59830A7	3850815	EJE LARGO CARDAN	YOKE DRIVE-SHAFT	ALBERINO CARDANO	FOURCHE DE CARDAN
37 REC997368	3852565	ARO TÓRICO	O-RING	O-RING	JOINT TORIQUE
38 REC22336734	22336734	CUBO	HUB	CUBO	CONNECTEUR CABLE DE COMMANDE
39 REC3854480	3854480	PASADOR HENDIDO	PIN	SPINOTTO	GOUVILLE
40 REC3850594	3850594	KIT REPARACIÓN	GASKET KIT	KIT RIPARAZIONE	KIT JOINTS HAUT D'EMBASE
41 REC39631		KIT AROS TRANSON SX	OUTDRIVE SEAL KIT	KIT TENUTE TRANSON SX	KIT JOINT DE PLATINE SX



PARTE SUPERIOR  
SX-A, FWD, DPS-A, DPS-B

UPPER HOUSING  
SX-A, FWD, DPS-A, DPS-B

PARTE SUPERIORE  
SX-A, FWD, DPS-A, DPS-B

PARTIE SUPÉRIEUR  
SX-A, FWD, DPS-A, DPS-B

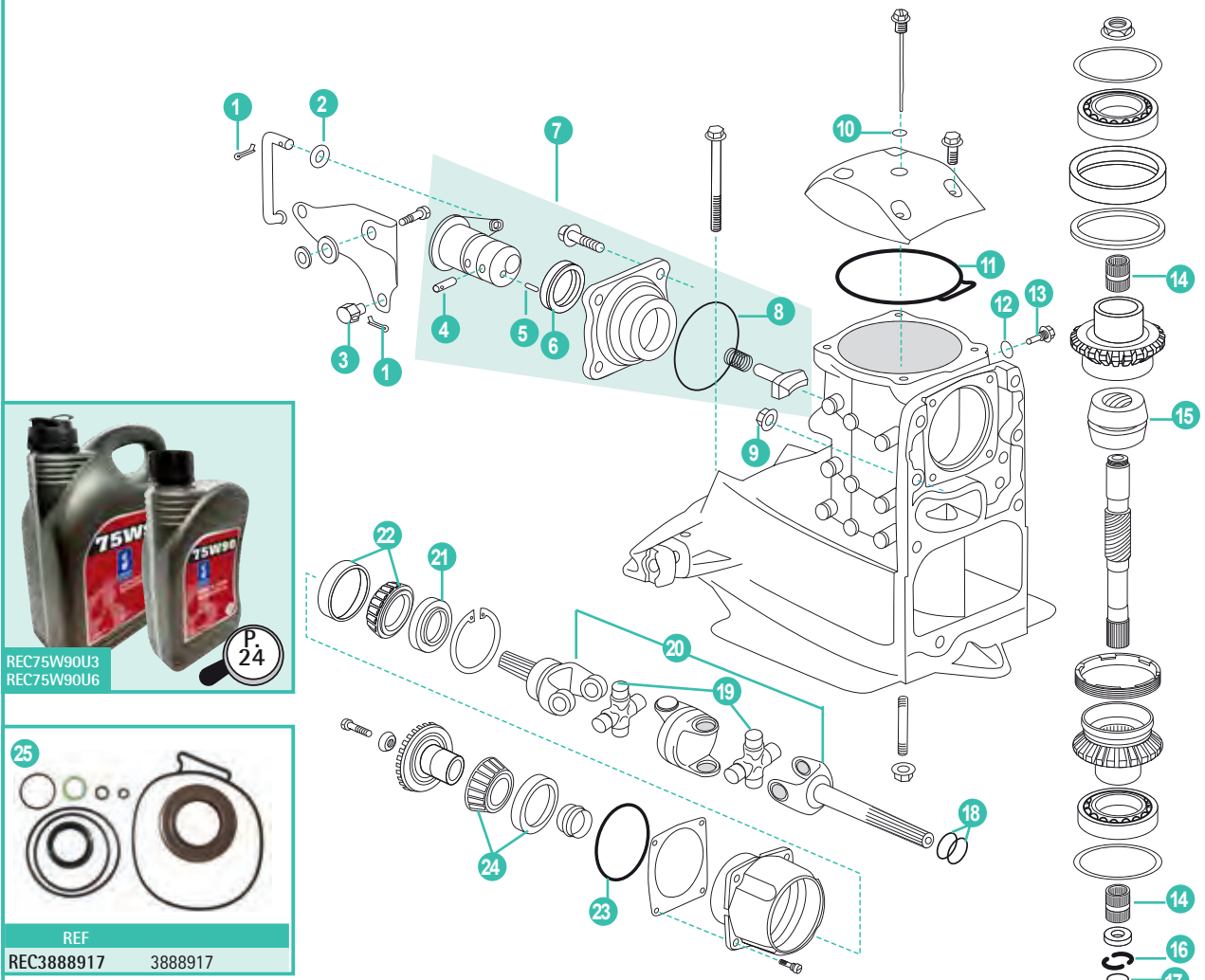

REF	OEM					
1	REC3854480	3854480	PASADOR HENDIDO	PIN	SPINOTTO	GOUPILLE
2	PAGB/T97.1-8	3852193	ARANDELA	WASHER	RONDELLA	RONDELLE
3	REC22336734	22336734	CUBO	HUB	CUBO	CONNECTEUR CABLE DE COMMANDE
4	REC3862867	3862867	PASADOR	PIN	SPINOTTO	GOUPILLE
5	REC951936	951936	PASADOR TUBULAR	PIN	SPINOTTO	GOUPILLE
6	REC3863085	3863085	RETÉN	SEAL RING	O-RING TENUTA	JOINT SPI
7	REC21256410	21256410	MECANISMO CAMBIO	SHIFT MECHANISM	MECCANISMO DI CAMBIO	MÉCANISME DE CHANGEMENT
8	REC925093	925093	ARO TÓRICO	O-RING	O-RING	JOINT TORIQUE
9	REC11-859135	3852648	TUECA	NUT	DADO	ÉCROU
10	REC3852045	3852045	ARO TÓRICO	O-RING	O-RING	JOINT TORIQUE
11	REC3889782	3889782	JUNTA	GASKET	GUARNIZIONE	JOINT
12	REC3855081	3855081	ARO TÓRICO	O-RING	O-RING	JOINT TORIQUE
13	REC22-67892A05	3854539	TAPÓN	CAP	TAPPO	BOUCHON
14	RM3852390	3852390	COJINETE	BEARING	CUSCINETTO	ROULEMENT
15	RM3807613	3807613	CONO SELECTOR	SLIDING SLEEVE	CONO SELETTORE	CONE D EMBRAYAGE
16	REC3852295	3852295	CLIP	CLIP	CLIP	CLI'
17	REC949656	949656	ARO TÓRICO	O-RING	O-RING	JOINT TORIQUE
18	REC997368	997368	ARO TÓRICO	O-RING	O-RING	JOINT TORIQUE
19	REC3850812	3850812	CRUCETA	UNIVERSAL JOINT	CROCETTA CARDANO	CROISILLON D'EMBASE
20	RM3860842	3860842	TRANSMISIÓN COMPLETA	U-JOINT ASSEMBLY	KIT CARDANO	CARDAN COMPLET
21	REC3852272	3852272	RETÉN	SEAL	TENUTA	JOINT SPI
22	REC183247	183247	COJINETE RODILLO	BEARING	CUSCINETTO	ROULEMENT CONIQUE
23	REC967344	967344	ARO TÓRICO	O-RING	O-RING	JOINT TORIQUE
24	REC3850852	3850852	COJINETE	BEARING	CUSCINETTO	ROULEMENT CONIQUE
25	REC3888917	3888917	KIT JUNTAS	SEAL KIT	KIT GUARNIZIONE	KIT JOINTS HAUT D'EMBASE



PARTE SUPERIOR  
DP-G, DPX-A

UPPER HOUSING  
DP-G, DPX-A

PARTE SUPERIORE  
DP-G, DPX-A

PARTIE SUPÉRIEUR  
DP-G, DPX-A



REC75W140U6

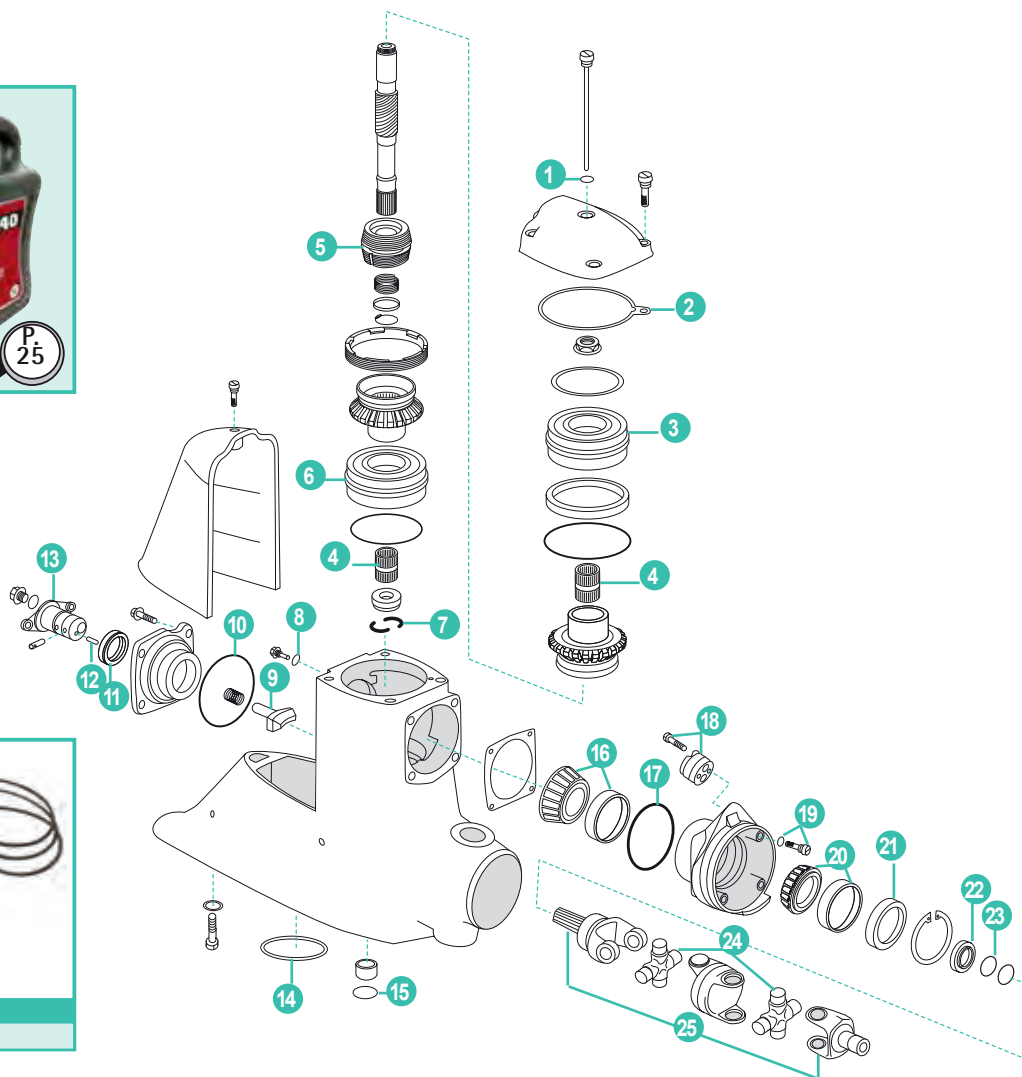

REF

REC23034

REF	OEM					
1	REC3852045	3852045	ARO TÓRICO	O-RING	O-RING	JOINT TORIQUE
2	REC3860183	3860183	JUNTA	GASKET	GUARNIZIONE	JOINT SPI
3	REC3857176	3857176	COJINETE	BEARING	CUSCINETTO	ROULEMENT
4	RM3852390	3852390	COJINETE	BEARING	CUSCINETTO	ROULEMENT
5	RM3807613	3807613	CONO SELECTOR	GEAR SLIDING SLEEVE	CONO SELETTORE	CONE D EMBRAYAGE
6	REC3857176	3857176	COJINETE	BEARING	CUSCINETTO	ROULEMENT
7	REC3852295	3852295	CLIP	CLIP	CLIP	CLIP
8	REC3855081	3855081	JUNTA	GASKET	GUARNIZIONE	JOINT
9	RM3856502	3856502	PUNTERA CONO SELECTOR	GEAR DOG	PERNO CONO SELETTORE	DOIGT DE SELECTEUR
10	REC925093	925093	RETÉN	O-RING	O-RING	JOINT TORIQUE
11	REC853868	853868	RETÉN	SEAL	TENUTA	JOINT SPI
12	REC973593	973593	PIN	PIN	PIN	PIN
13	REC3856008	3856008	PISTÓN SELECTOR	SHIFT PLUNGER	PISTONE SELETTORE SHIFT PLUNGER	SÉLECTEUR DE VITESSE
14	REC925256	925256	ARO TÓRICO	O-RING	O-RING	JOINT TORIQUE
15	REC125017	125017	ARO TÓRICO	O-RING	O-RING	JOINT TORIQUE
16	REC3850852	3850852	COJINETE	BEARING	CUSCINETTO	ROULEMENT
17	REC967344	967344	ARO TÓRICO	O-RING	O-RING	JOINT TORIQUE
18	REC852705	852705	DADO DIRECCIÓN	PIVOT PIN	DADO	AXE DE PIVOTEMENT
19	REC984068	984068	KIT TORNILLOS	SCREW KIT	KIT VITE	KIT VISSES
20	REC183247	183247	COJINETE	BEARING	CUSCINETTO	ROULEMENT
21	REC839253	839253	RETÉN	SEAL	TENUTA	JOINT SPI
22	REC832675	832675	ARANDELA	WASHER	RONDELLA	RONDELLE
23	REC956000	956000	ARO TÓRICO	O-RING	O-RING	JOINT TORIQUE
24	REC3860232	3860232	CRUCETA CARDAN	UNIVERSAL JOINT	CROCETTA CARDANO	CROISSILLON D'EMBASE
25	RM3860230	3860230	KIT TRANSMISION 290SP/DP	U-JOINT ASSEMBLY 290SP/DP	KIT CARDANO 290SP/DP	CARDAN 290SP/DP

PARTE INFERIOR  
AQUAMATIC

LOWER HOUSING  
AQUAMATIC

PARTE INFERIORE  
AQUAMATIC

PARTIE INFÉRIEURE  
AQUAMATIC

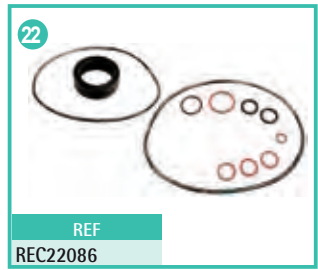
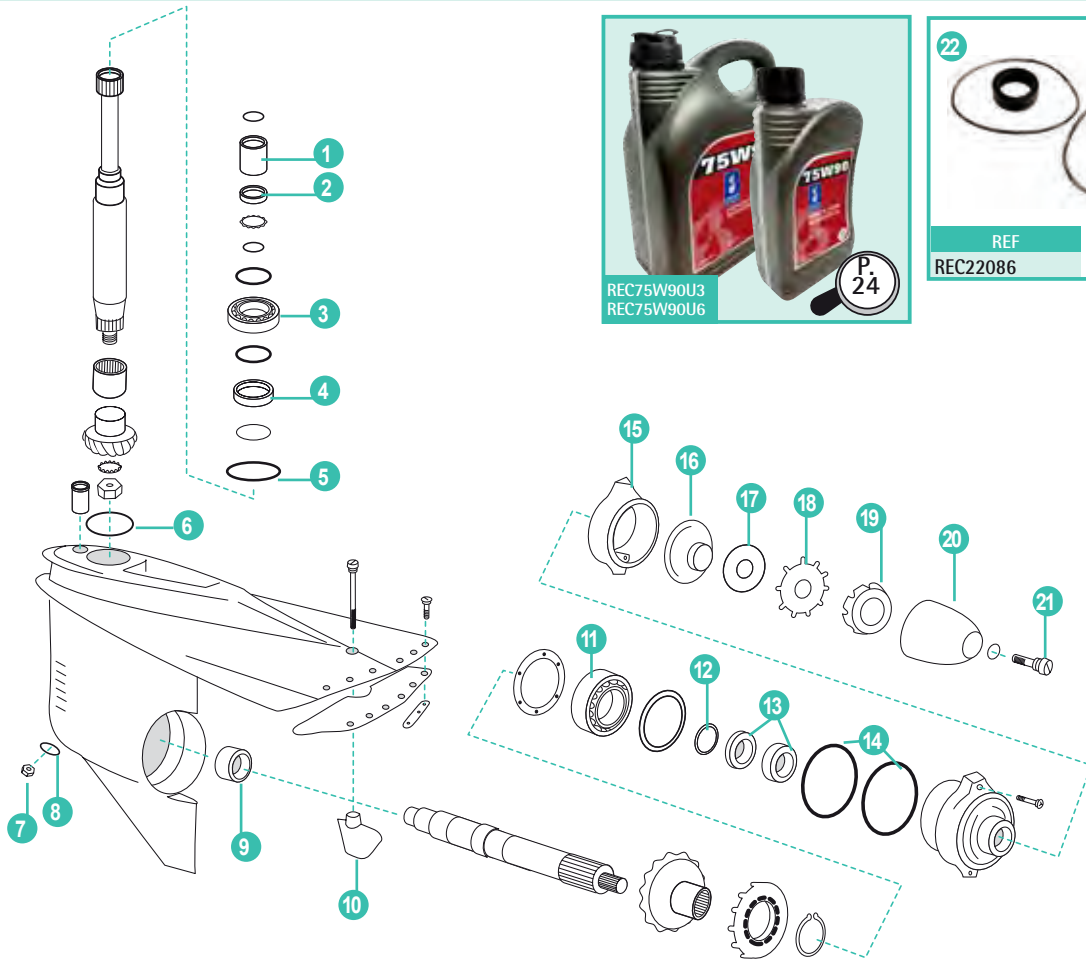

REF	OEM					
1	RM3852268	3852268	CASQUILLO ESTRIADO	SPLINDED BUSHING	BOCCOLA	MANCHON CANNELE
2	REC969071	969071	TUERCA	NUT	DADO	ÉCROU
3	REC11072	11072	COJINETE	BEARING	CUSCINETTO	ROULEMENT
4	REC183374	183374	COJINETE	BEARING	CUSCINETTO	ROULEMENT
5	REC832191	832191	JUNTA	GASKET	GUARNIZIONE	JOINT
6	REC925256	925256	ARO TÓRICO	O-RING	O-RING	JOINT TORIQUE
7	RM852904	852904	TAPON	PLUG	TAPPO	BOUCHON
8	REC955974	955974	ARO TÓRICO	FILL SCREW O-RING	O-RING	JOINT TORIQUE
9	REC183390	183390	COJINETE AGUJAS	NEEDLE BEARING	CUSCINETTO A RULLI	ROULEMENT A AIGUILLES
10	REC854040	854040	TIMÓN	TRIM FIN	TIMONE	DERIVE
11	REC854541	854541	COJINETE	BEARING	CUSCINETTO	ROULEMNET
12	REC969073	969073	TUERCA	NUT	DADO	ÉCROU
13	REC897426	897426	RETENES EJE HELICE	PROP SHAFT SEALS	PARAOLIO ASSE ELICA	JOINT SPI ARBRE D'HELICE
14	REC925261	925261	ARO TÓRICO	O-RING	O-RING	JOINT TORIQUE
	CMCMV-18	875815	ÁNODO Zn (AQ280SP, 290SP)	Zn ANODE (AQ280SP, 290SP)	ANODO Zn (AQ280SP, 290SP)	ANODE Zn (AQ280SP, 290SP)
	CMCMV-18A	875815	ÁNODO AI (AQ280SP, 290SP)	AI ANODE (AQ280SP, 290SP)	ANODO AI (AQ280SP, 290SP)	ANODE AI (AQ280SP, 290SP)
	CMV-17	875805	ÁNODO Zn (AQ250, 270, 275)	Zn ANODE (AQ250, 270, 275)	ANODO Zn (AQ250, 270, 275)	ANODE Zn (AQ250, 270, 275)
15	REC875821	875821	ÁNODO Zn (AQ280DP, 290DP)	Zn ANODE (AQ280DP, 290DP)	ANODO Zn (AQ280DP, 290DP)	ANODE Zn (AQ280DP, 290DP)
	REC875821AL	875821	ÁNODO AI (AQ280DP, 290DP)	AI ANODE (AQ280DP, 290DP)	ANODO AI (AQ280DP, 290DP)	ANODE AI (AQ280DP, 290DP)
	REC23172849	876286	ÁNODO Zn (AQ120)	Zn ANODE (AQ120)	ANODO Zn (AQ120)	ANODE Zn (AQ120)
	REC839423	839423	CORTALINEAS (AQ280SP, 290SP)	LINE CUTTER (AQ280SP, 290SP)	REGGISPINTA (AQ280SP, 290SP)	COUPE FIL (AQ280SP, 290SP)
16	REC872082	872082	CORTALINEAS (AQ280, 290SP)	LINE CUTTER (AQ280SP, 290SP)	REGGISPINTA (AQ280SP, 290SP)	COUPE FIL (AQ280SP, 290SP)
	REC839534	839534	CORTALINEAS (AQ250, 270, 275)	LINE CUTTER (AQ250, 270, 275)	REGGISPINTA (AQ250, 270, 275)	COUPE FIL (AQ250, 270, 275)
17	REC850888	850888	ARANDELA PLASTICO	PLASTIC WASHER	RONDELLA PLASTICA	RONDELLE PLASTIQUE
18	REC897367	897367	ARANDELA CIERRE HELICE	PROP LOCK TAB WASHER	RONDELLA CIUSURA ELICA	RONDELLE FREIN D'HELICE
19	REC854047	854047	ESPACIADOR HELICE	PROP SPACER WASHER	SPESSORE ELICA	ENTRETOISE D'HELICE
20	REC854045	854045	CONO HÉLICE INCLUYE TORNILLO	PROP CONE NUT (INCLUDES SCREW)	CONO ELICA (VITE INCLUSA)	CONE D'HELICE AVEC VIS
21	REC850889	850889	TORNILLO CONO	SCREW FOR PROP CONE NUT	VITE CONO	VIS DE CONE
22	REC22086		KIT DE RETENES (DP: AQ200, AQ290, AQSP)	SEAL KIT (DP: AQ200, AQ290, AQSP)	KIT RIPARAZIONE (DP: AQ200, AQ290, AQSP)	KIT JOINTS (DP: AQ200, AQ290, AQSP)

**PARTE INFERIOR  
AQUAMATIC DP**

**LOWER HOUSING  
AQUAMATIC DP**

**PARTE INFERIORE  
AQUAMATIC DP**

**PARTIE INFÉRIEURE  
AQUAMATIC DP**

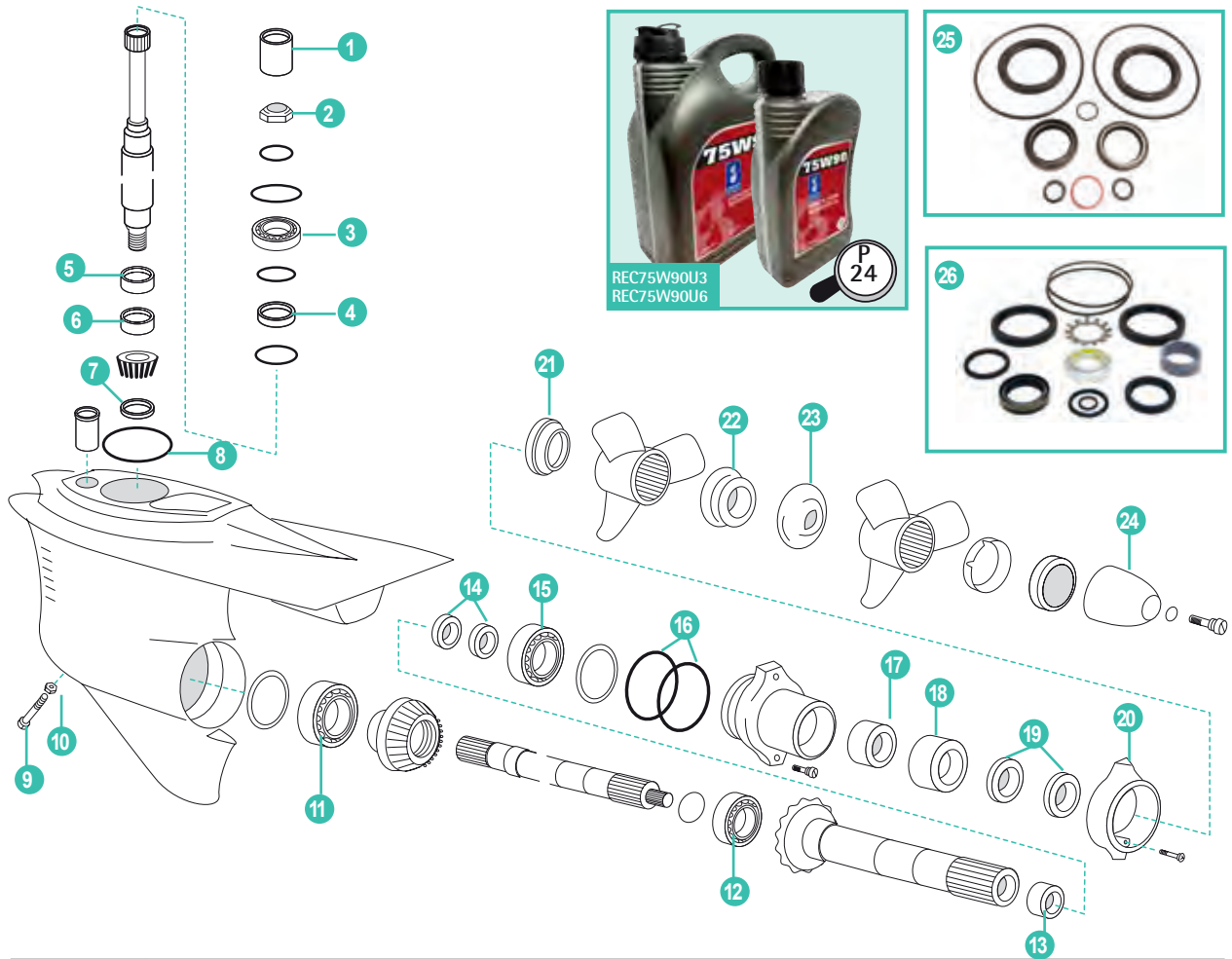

REF	OEM					
1	RM3852268	3852268	MANGUITO ESTRIADO	SPLINED SLEEVE	MANICOTTO SCANALATO	MANCHON CANNELÉ
2	REC969071	969071	TUERCA REDONDA	ROUND NUT	DADO	ÉCROU
3	REC11072	11072	COJINETE	ROLLER BEARING	CUSCINETTO	ROULEMENT
4	REC183374	183374	COJINETE	BALL BEARING	CUSCINETTO	ROULEMENT
5	REC184682	184682	ARO INTERIOR	RING	O-RING INTERNO	BAGUE INTÉRIEURE
6	REC184654	184654	COJINETE AGUJAS	NEEDLE ROLLER BEARING	CUSCINETTO A RULLI	ROULEMENT A AIGUILLE
7	REC852212	852212	TUERCA	NUT	DADO	ÉCROU
8	REC925256	925256	ARO TÓRICO	O-RING	O-RING	JOINT TORIQUE
9	RM852904	852904	TAPÓN	CAP	TAPPO	BOUCHON DE VIDANGE
10	REC955974	955974	ARO TÓRICO	O-RING	O-RING	JOINT DE VIDANGE
11	REC11044	11044	COJINETE	ROLLER BEARING	CUSCINETTO	ROULEMENT
12	RM184691	184691	COJINETE	ROLLER BEARING	CUSCINETTO	ROULEMENT
13	REC183272	183272	COJINETE AGUJAS	NEEDLE ROLLER BEARING	CUSCINETTO A RULLI	ROULEMENT A AIGUILLE
14	REC22087		KIT RETENES Y AROS EJE HELICE	SEALING RING KIT	KIT TENUTE & ANELLI ASSE ELICA	KIT JOINTS SPI
15	REC184765	184765	COJINETE RODILLO	ROLLER BEARING	CUSCINETTO A RULLI	ROULEMENT
16	REC925258	925258	ARO TÓRICO	O-RING	FACIA TONDA	JOINT TORIQUE
17	REC184683	184683	ARO INTERIOR	RING	O-RING INTERNO	BAGUE INTÉRIEURE
18	REC183859	183859	COJINETE	NEEDLE ROLLER BUSHING	CUSCINETTO	ROULEMENT
19	REC851407	851407	RETEN EJE HELICE	SEALING RING	PARAOLIO ASSE ELICA	JOINT SPI
20	REC875821	875821	ÁNODO Zn	Zn ANODE	ANODO Zn	ANODE Zn
	REC875821AL	875821	ÁNODO AI	AI ANODE	ANODO AI	ANODE AI
21	REC3858457	3858457	CORTALINEAS FRONTAL	THRUST RING, FRONT	O-RING REGGISPINTA FRONTALE	COUPE FIL FRONTAL
22	RM3851334	3851334	TUERCA HELICE	PROPELLER NUT	DADO ELICA	ÉCROU D'HELICE
23	REC3858458	3858458	CORTALINEAS TRASERO	THRUST RING, REAR	O-RING REGGISPINTA POSTERIORE	COUPE FIL ARRIÈRE
24	RM872549	872549	KIT TUERCA HELICE Ø 20 mm.	PROPELLER CONE Ø 20 mm	KIT ELICA Ø 20 mm	KIT CONE D'HELICE Ø 20 mm
	RM872614	872614	KIT TUERCA HELICE Ø 16 mm.	PROPELLER CONE Ø 16 mm	KIT ELICA Ø 16 mm	KIT CONE D'HELICE Ø 16 mm
25	REC22087		KIT AQ280DP, 290DP, DP	KIT AQ280DP, 290DP, DP	KIT AQ280DP, 290DP, DP	KIT JOINTS 280DP, 290DP, DP
26	REC876267		KIT DP-C1, D1, E DPX-S, S1	KIT DP-C1, D1, E DPX-S, S1	KIT DP-C1, D1, E DPX-S, S1	KIT JOINTS DP-C1, D1, E DPX-S, S1

PARTE INFERIOR SX

LOWER HOUSING SX

PARTE INFERIORE SX

PARTIE INFÉRIEURE SX

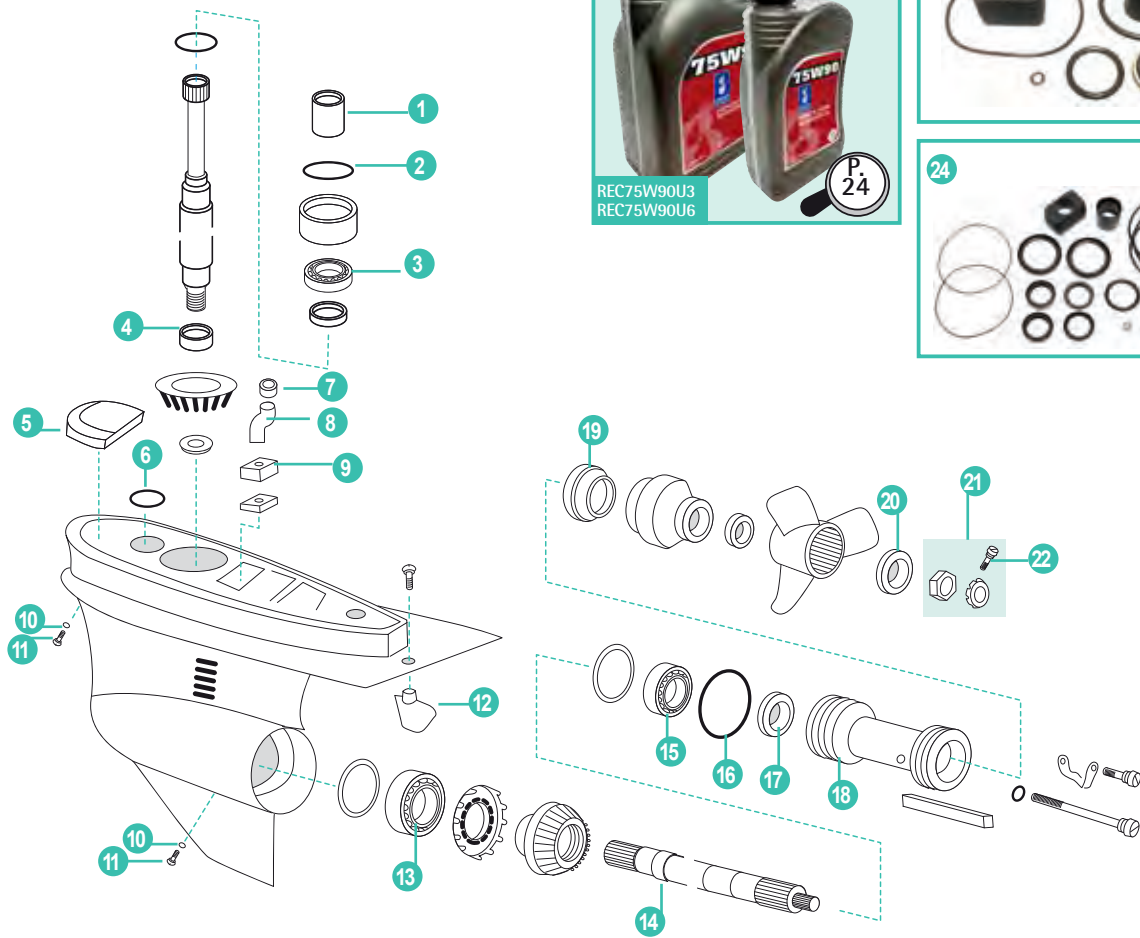

REF	OEM					
1	RM3852268	3852268	CASQUILLO	BUSHING	BOCCOLA	MANCHON CANNELE
2	REC3852866	3852866	ARO TÓRICO	WASHER	O-RING	JOINT TORIQUE
3	REC31-86748A1	3854250	COJINETE	BEARING	CUSCINETTO	ROULEMENT
4	REC3853934	3853934	COJINETE	BEARING	CUSCINETTO	ROULEMENT
5	REC3855411	3855411	ANODO Zn	ANODE Zn	ANODO Zn	ANODE Zn
6	REC3863193AL	3863193	ÁNODO Al	ANODE Al	ANODO Al	ANODE Al
7	REC3852959	3852959	ARO TÓRICO	O-RING	O-RING	JOINT TORIQUE
8	REC3852315	3852315	CASQUILLO GOMA	RUBBER INSERT	BOCCOLA IN GOMMA	BAGUE IN CAOUTCHOUC
9	RM3860252	3860252	TUBO DE AGUA	WATER TUBE	TUBO DELL'ACQUA	DURITE D'EAU
10	REC3854595	3854595	RETÉN	SEAL	PARAOLIO	JOINT SPI
11	REC3855081	3855081	ARANDELA	WASHER	RONDELLA	RONDELLE
12	REC22-67892A05	3854539	TORNILLO	SCREW	VITE	VIS
13	REC854040	854040	TIMÓN	TRIM TAB	TIMONE	DERIVE
14	REC3850942	3850942	COJINETE	BEARING	CUSCINETTO	ROULEMENT
15	REC3857675	3857675	EJE HÉLICE	PROP SHAFT	ASSE ELICA	ARBRE D'HÉLICE
16	REC31-66668A1	3854249	COJINETE	BEARING	CUSCINETTO	ROULEMENT
17	REC3852865	3852865	ARO TÓRICO	WASHER	RONDELLA	JOINT TORIQUE
18	REC3863090	3863090	RETÉN	SEAL	TENUTA	JOINT SPI
19	RM3858051	3858051	DIÁBOLO	HOUSING BEARING	DIABOLO	DIABOLO
20	REC126870	3852020	CIERRE HÉLICE	THRUST WASHER	CHIUSURA ELICA	ÉCROU D'HÉLICE
21	REC3852350	3852350	TOPE HÉLICE	THRUST HUB	FERMO PER ELICA	RONDELLE BUTEE D'HELICE
22	REC398042	3850984	KIT TUERCA HÉLICE	PROP & NUT KEEPER	KIT DADO ELICA	KIT ECROU D'HELICE
23	REC3852056	3852056	PASADOR	PIN	COPPIGLIA	GOUPILLE
24	REC3855275	3855275	KIT REPARACIÓN	REPAIR KIT	KIT RIPARAZIONE	KIT JOINTS
24	REC3856002	3856002	KIT REPARACIÓN	REPAIR KIT	KIT RIPARAZIONE	KIT JOINTS



PARTE INFERIOR  
DP-S

LOWER HOUSING  
DP-S

PARTE INFERIORE  
DP-S

PARTIE INFÉRIEURE  
DP-S

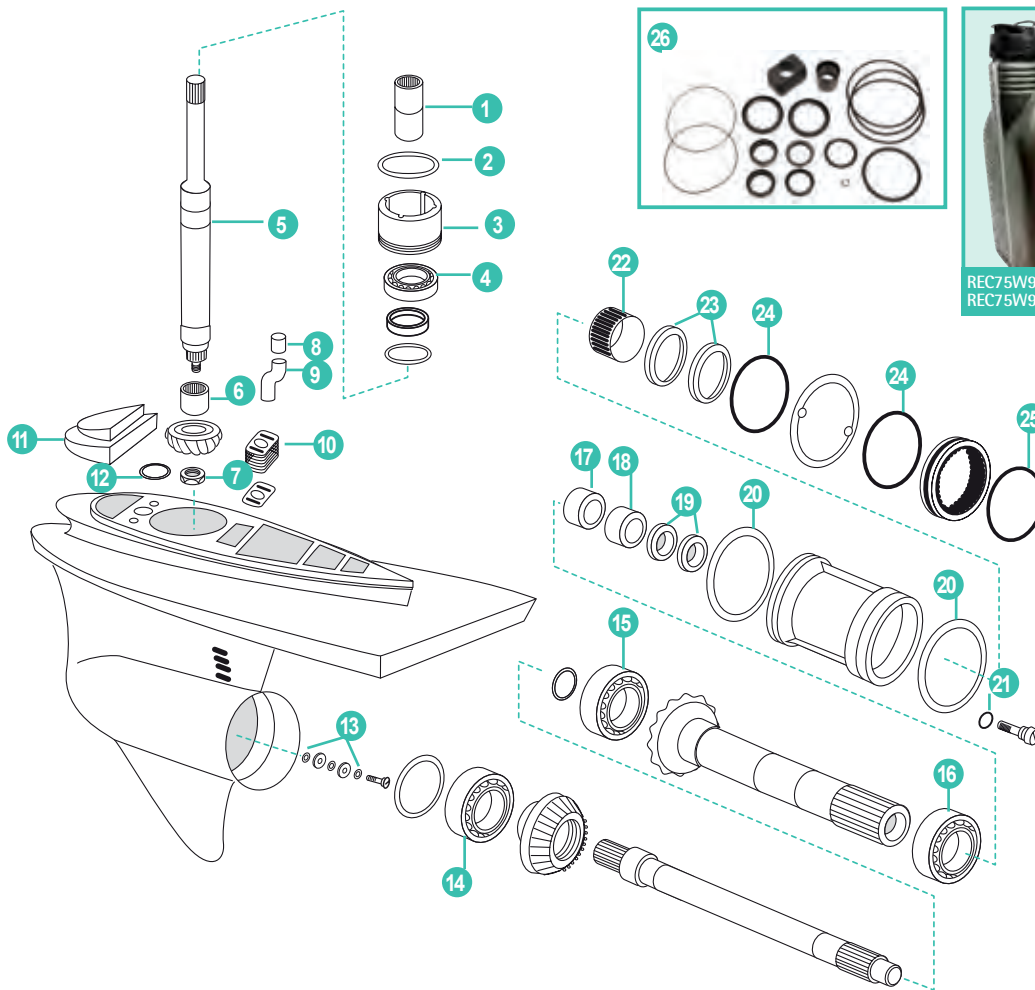

REF	OEM					
1	RM3852268	3852268	CASQUILLO ESTRIADO	SPLINED SLEEVE	CAPPUCCIO	MANCHON CANNELÉ
2	REC3852866	3852866	ARO TÓRICO	O-RING	O-RING	JOINT TORIQUE
3	REC31-86748A1	3854250	COJINETE RODILLO	BEARING	CUSCINETTO	ROULEMENT
4	REC31-66668A1	3854249	COJINETE	BEARING	CUSCINETTO	ROULEMENT
5	REC184682	184682	ANILLO INTERIOR	RING	O-RING	JOINT TORIQUE
6	REC184654	184654	COJINETE DE RODILLO	BEARING	CUSCINETTO	ROULEMENT
7	REC852212	852212	TUERCA	NUT	DADO	ÉCROU
8	REC3852315	3852315	CASQUILLO GOMA	RUBBER SEAL	PARAOILIO IN GOMMA	BAGUE CAOUTCHOUC
9	RM3860252	3860252	TUBO	PIPE	TUBO	DURITE
10	REC3854595	3854595	RETÉN	SEAL	TENUTA	JOINT SPI
11	REC3855411	3855411	ANODO Zn	ANODE Zn	ANODO Zn	ANODE Zn
	REC3863193AL	3863193	ÁNODO AI	ANODE AI	ANODO AI	ANODE AI
12	REC3852959	3852959	ARO TÓRICO	O-RING	O-RING	JOINT TORIQUE
13	REC955893	955893	ARANDELAS	WASHERS	RONDELLE	RONDELLE
14	REC11044	11044	COJINETE DE RODILLO	BEARING	CUSCINETTO	ROULEMENT
15	RM184691	194691	COJINETE DE RODILLO	BEARING	CUSCINETTO	ROULEMENT
16	REC184765	184765	COJINETE DE RODILLO	BEARING	CUSCINETTO	ROULEMENT
17	REC184683	184683	ANILLO INTERIOR	RING	O-RING	BAGUE INTERIEURE
18	REC183272	183272	COJINETE DE RODILLO	BEARING	CUSCINETTO	ROULEMENT
19	REC853808	853808	RETÉN	SEALING RING	O-RING TENUTA	JOINT SPI
20	REC3854625	3854625	ARO TÓRICO	O-RING	O-RING	JOINT TORIQUE
21	REC955981	955981	ARO TÓRICO	O-RING	O-RING	JOINT TORIQUE
22	REC183859	183859	COJINETE DE RODILLO	BEARING	CUSCINETTO	ROULEMENT DE DIABOLO
23	REC851407	851407	RETÉN	SEALING RING	O-RING TENUTA	JOINT SPI
24	REC946438	946438	ARO TÓRICO	O-RING	O-RING	JOINT TORIQUE
25	REC3854624	3854624	ARO TÓRICO	O-RING	O-RING	JOINT TORIQUE
26	REC3856002	3856002	KIT REPARACIÓN	REPAIR KIT	KIT RIPARAZIONE	KIT JOINTS

PARTE INFERIOR  
DP-SM

LOWER HOUSING  
DP-SM

PARTE INFERIORE  
DP-SM

PARTIE INFÉRIEURE  
DP-SM

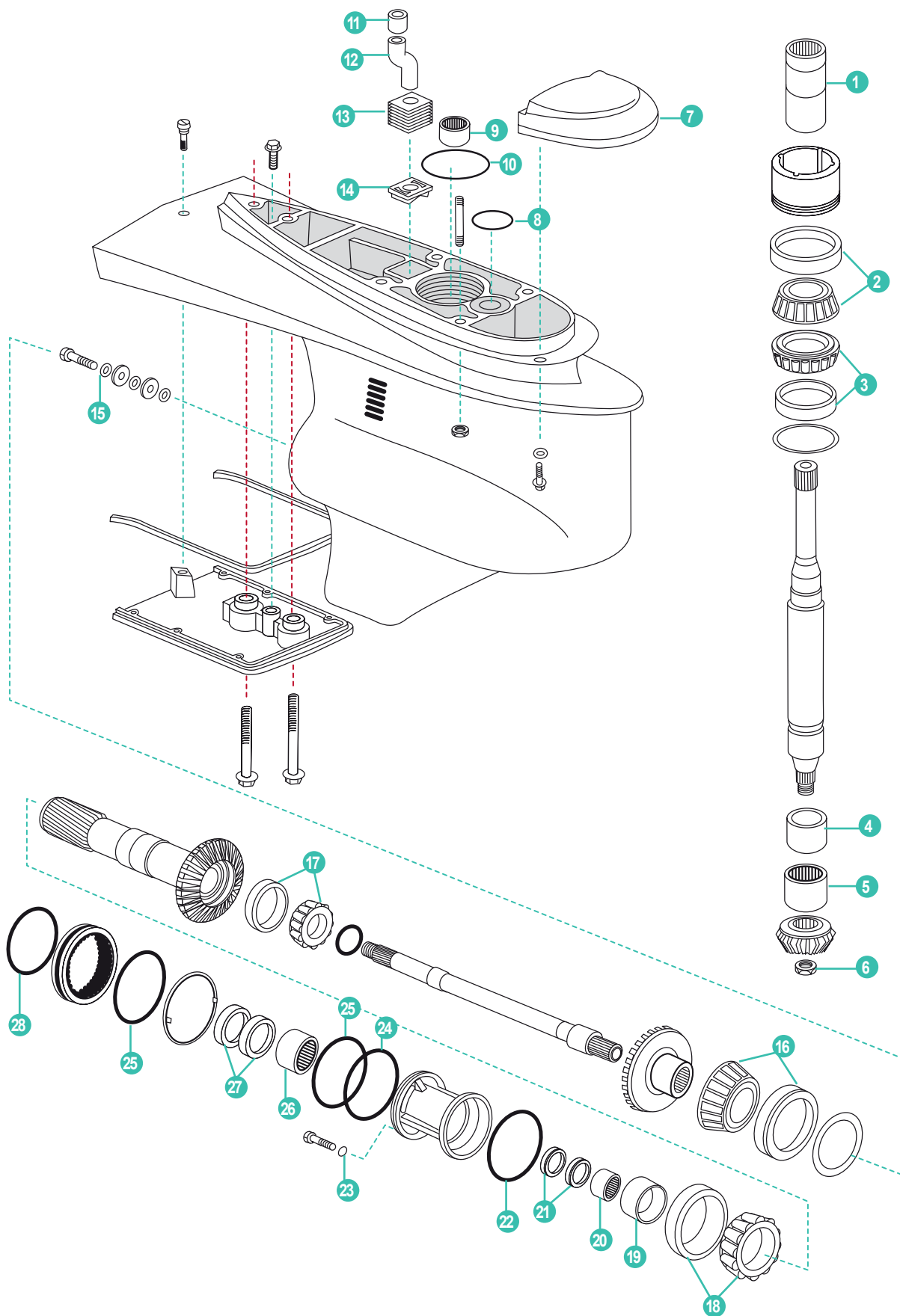

	REF	OEM				
1	RM3852268	3852268	CASQUILLO ESTRIADO	SPLINED SLEEVE	CAPPUCCIO	MANCHON CANNELÉ
2	REC31-86748A1	183512	COJINETE DE RODILLO	BEARING	CUSCINETTO	ROULEMENT
3	REC31-66668A1	3854249	COJINETE DE RODILLO	BEARING	CUSCINETTO	ROULEMENT
4	REC184682	184682	ANILLO INTERIOR	RING	O-RING	BAGUE INTERIEURE
5	REC184654	184654	COJINETE DE RODILLO	BEARING	CUSCINETTO	ROULEMENT A AIGUILLE
6	REC852212	852212	TUERCA	NUT	DADO	ÉCROU
7	REC3855411	3855411	ANODO Zn	ANODE Zn	ANODO Zn	ANODE Zn
	REC3863193AL	3863193	ÁNODO AI	ANODE AI	ANODO AI	ANODE AI
8	REC3852959	3852959	ARO TÓRICO	O-RING	FASCIA TONDA	JOINT TORIQUE
9	REC184654	184654	COJINETE	NEEDLE BEARING	CUSCINETTO	ROULEMENT
10	REC3852866	3852866	ARO TÓRICO	O-RING	FASCIA TONDA	JOINT TORIQUE
11	REC3852315	3852315	CASQUILLO GOMA	RUBBER SEAL	PARAOILIO IN GOMMA	BAGUE CAOUTCHOUC
12	RM3860252	3860252	TUBO	PIPE	TUBO	DURITE
13	REC3854595	3854595	RETÉN	SEAL	PARAOILIO	JOINT SPI
14	REC3854601	3854601	SOPORTE TUBO AGUA	RETAINER	SUPPORTO TUBO ACQUA	SUPPORT TUBE D'EAU
15	REC955893	955893	ARANDELA	WASHER	RONDELLA	RONDELLE
16	REC11044	11044	COJINETE DE RODILLO	BEARING	CUSCINETTO	ROULEMENT CONIQUE
17	RM184691	184691	COJINETE DE RODILLO	BEARING	CUSCINETTO	ROULEMENT CONIQUE
18	REC184765	184765	COJINETE DE RODILLO	BEARING	CUSCINETTO	ROULEMENT CONIQUE
19	REC184683	184683	ANILLO INTERIOR	CONE	O-RING INTERNO	BAGUE INTERIEURE
20	REC183272	183272	COJINETE DE RODILLO	BEARING	CUSCINETTO	ROULEMENT A AIGUILLE
21	REC853808	853807+853808	KIT RETÉN	KIT SEAL	KIT TENUTA	KIT JOINTS SPI
22	REC3854625	3854625	ARO TÓRICO	O-RING	O-RING	JOINT TORIQUE
23	REC955981	955981	ARO TÓRICO	O-RING	O-RING	JOINT TORIQUE
24	REC3854625	3854625	ARO TÓRICO	O-RING	O-RING	JOINT TORIQUE
25	REC946438	946438	RETÉN	SEAL RING	O-RING TENUTA	JOINT SPI
26	REC183859	183859	COJINETE DE RODILLO	BEARING	CUSCINETTO	ROULEMENT A AIGUILLE
27	REC851407	851407	RETÉN	SEAL RING	O-RING TENUTA	JOINT SPI
28	REC3854624	3854624	ARO TÓRICO	O-RING	O-RING	JOINT TORIQUE
29	REC3856002	3856002	KIT REPARACIÓN	REPAIR KIT	KIT RIPARAZIONE	KIT JOINTS



PARTE INFERIOR  
DPS-A, DPS-B

LOWER HOUSING  
DPS-A, DPS-B

PARTE INFERIORE  
DPS-A, DPS-B

PARTIE INFÉRIEURE  
DPS-A, DPS-B



REC75W90U3  
REC75W90U6

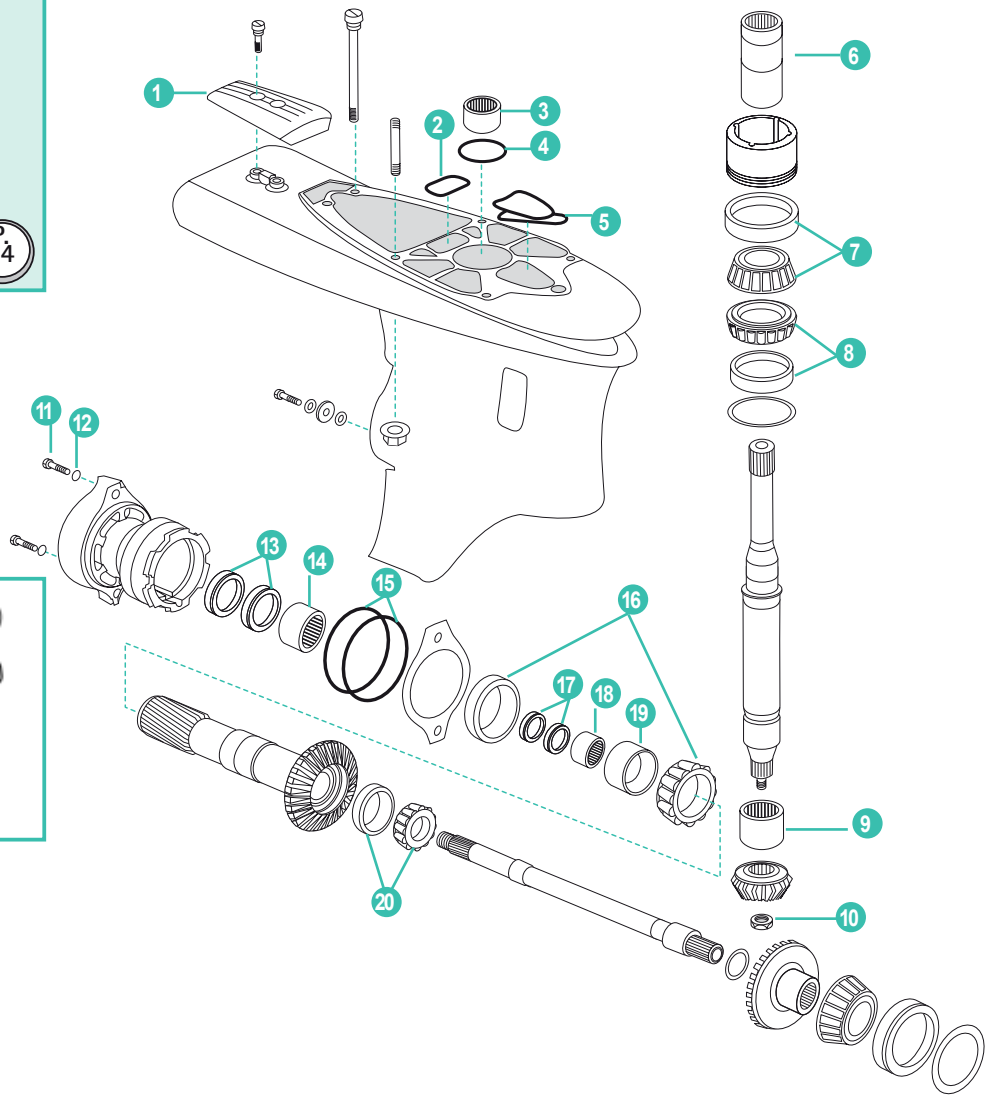

REF  
REC23020

	REF	OEM			
1	REC3888814	3888814	KIT ÁNODOS Zn	ANODES Zn SET	KIT ANODI Zn
	REC23164609AL	3888813	KIT ÁNODOS AI	ANODES AI SET	KIT ANODES AI
2	REC3889786	3889786	JUNTA	GASKET	GUARNIZIONE
3	REC184654	184654	CASQUILLO DE RODILLO	BUSHING	BOCCOLA
4	REC3852866	3852866	ARO TÓRICO	O-RING	O-RING
5	REC3889784	3889784	JUNTA	GASKET	GUARNIZIONE
6	RM3852268	3852268	CASQUILLO ESTRIADO	SPLINED SLEEVE	CAPPUCCIO
7	REC31-86748A1	3854250	COJINETE DE RODILLO	BEARING	CUSCINETTO
8	REC31-66668A1	3854249	COJINETE DE RODILLO	BEARING	CUSCINETTO
9	REC184654	184654	COJINETE	BEARING	CUSCINETTO
10	REC852212	852212	TUERCA	NUT	DADO
11	REC22-67892A05	3854539	TORNILLO CON RETÉN CIERRE	DRAINING SCREW SET	VITE CON PARAOLIO CHIUSURA
12	REC3855081	3855081	JUNTA	GASKET	GUARNIZIONE
13	REC851407	851407	RETÉN EJE HÉLICE	SEAL	PARAOLIO ASSE ELICA
14	REC183859	183859	COJINETE	BEARING	CUSCINETTO
15	REC925259	925259	ARO TÓRICO	O-RING	O-RING
16	REC184765	184765	COJINETE COLA	ROLLER BEARING	CUSCINETTO PIEDE
17	REC853808	853808 853807	RETENES EJE HÉLICE INTERIOR	SEAL RING PROPELLER SHAFT SET	PARAOLIO ASSE ELICA
18	REC183272	183272	COJINETE DE AGUJAS	NEEDLE BEARING	CUSCINETTO
19	REC184683	184683	ARO INTERIOR	CONE	O-RING INTERNO
20	RM184691	184691	COJINETE	BEARING	CUSCIENTTO
21	REC23020	3888822	KIT REPARACIÓN	REPAIR KIT	KIT RIPARAZIONE
					KIT JOINTS



PARTE INFERIOR  
SX-A

LOWER HOUSING  
SX-A

PARTE INFERIORE  
SX-A

PARTIE INFÉRIEURE  
SX-A



REC75W90U3  
REC75W90U6



REF  
REC23022

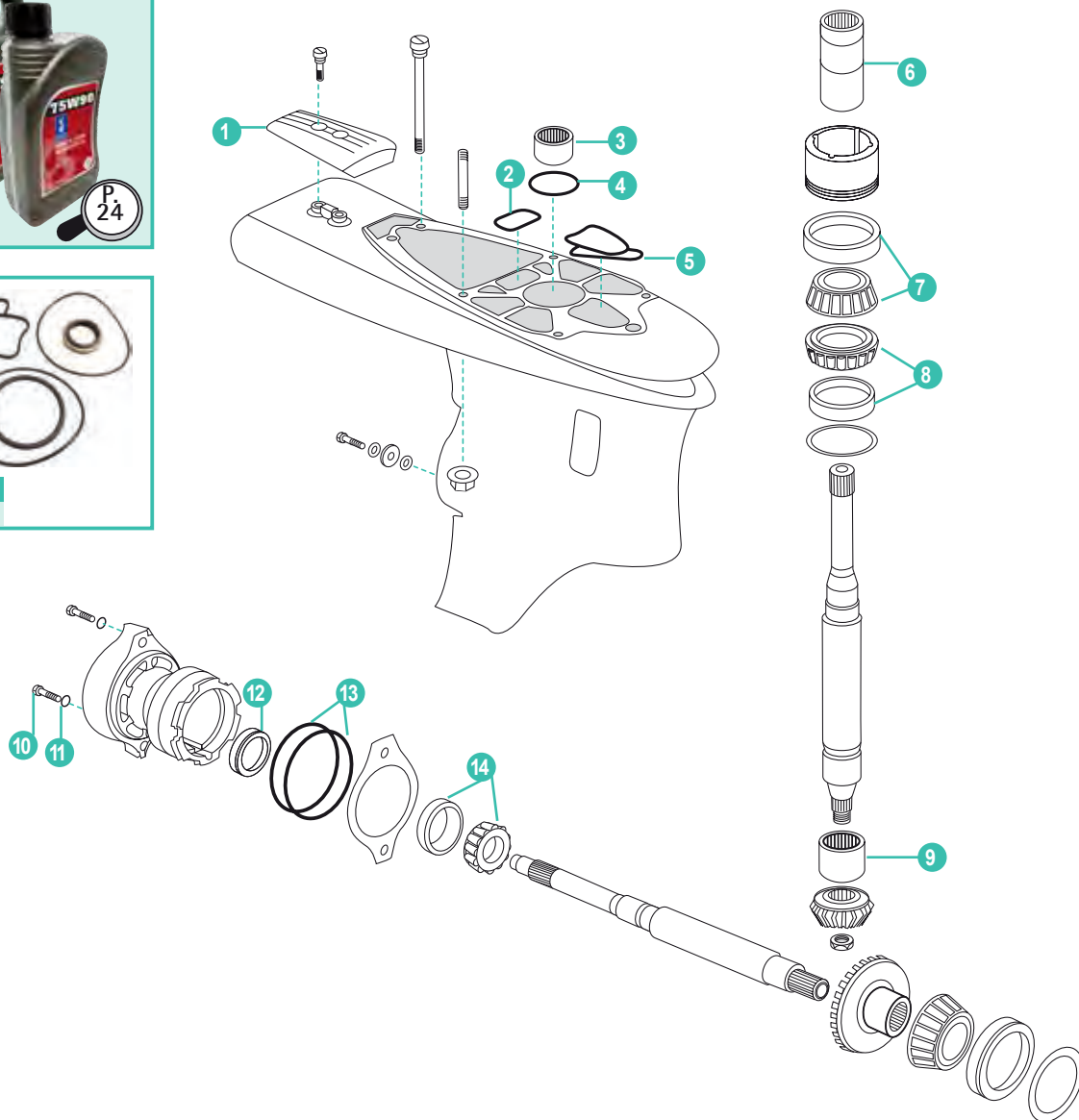

	REF	OEM				
1	REC3888814	3888814	ANODO Zn	ANODE Zn	ANODO Zn	ANODE Zn
	REC23164609AL	3888813	ÁNODO AI	ANODE AI	ANODO AI	ANODE AI
2	REC3889786	3889786	JUNTA	GASKET	GUARNIZIONE	JOINT
3	REC3853934	3853934	COJINETE	BEARING	CUSCINETTO	ROULEMENT A AIGUILLE
4	REC3852866	3852866	ARO TÓRICO	O-RING	O-RING	JOINT TORIQUE
5	REC3889784	3889784	JUNTA	GASKET	GUARNIZIONE	JOINT
6	RM3852268	3852268	MANGUITO ESTRIADO	STRAIGHTED SLEEVE	MANICOTTO SCANALATO	MANCHON CANNELE
7	REC31-86748A1	3854250	COJINETE DE RODILLO	BEARING	CUSCINETTO	ROULEMENT CONIQUE
8	REC31-66668A1	3854249	COJINETE DE RODILLO	BEARING	CUSCINETTO	ROULEMENT CONIQUE
9	REC3853934	3853934	COJINETE	BEARING	CUSCINETTO	ROULEMENT A AIGUILLE
10	REC22-67892A05	3854539	TORNILLO	SCREW	VITE	VIS
11	REC3855081	3855081	ARO TÓRICO	O-RING	O-RING	JOINT TORIQUE
12	REC3863090	3863090	RETÉN	SEAL	TENUTA	JOINT SPI
13	REC925259	925259	ARO TÓRICO	O-RING	O-RING	JOINT TORIQUE
14	REC31-66668A1	3854249	COJINETE DE RODILLO	BEARING	CUSCINETTO	ROULEMENT CONIQUE
15	REC23022	3888821	KIT REPARACIÓN	REPAIR KIT	KIT RIPARAZIONE	KIT JOINTS

PARTE INFERIOR FWD

LOWER HOUSING FWD

PARTE INFERIORE FWD

PARTIE INFÉRIEURE FWD



REC75W90U3  
REC75W90U6

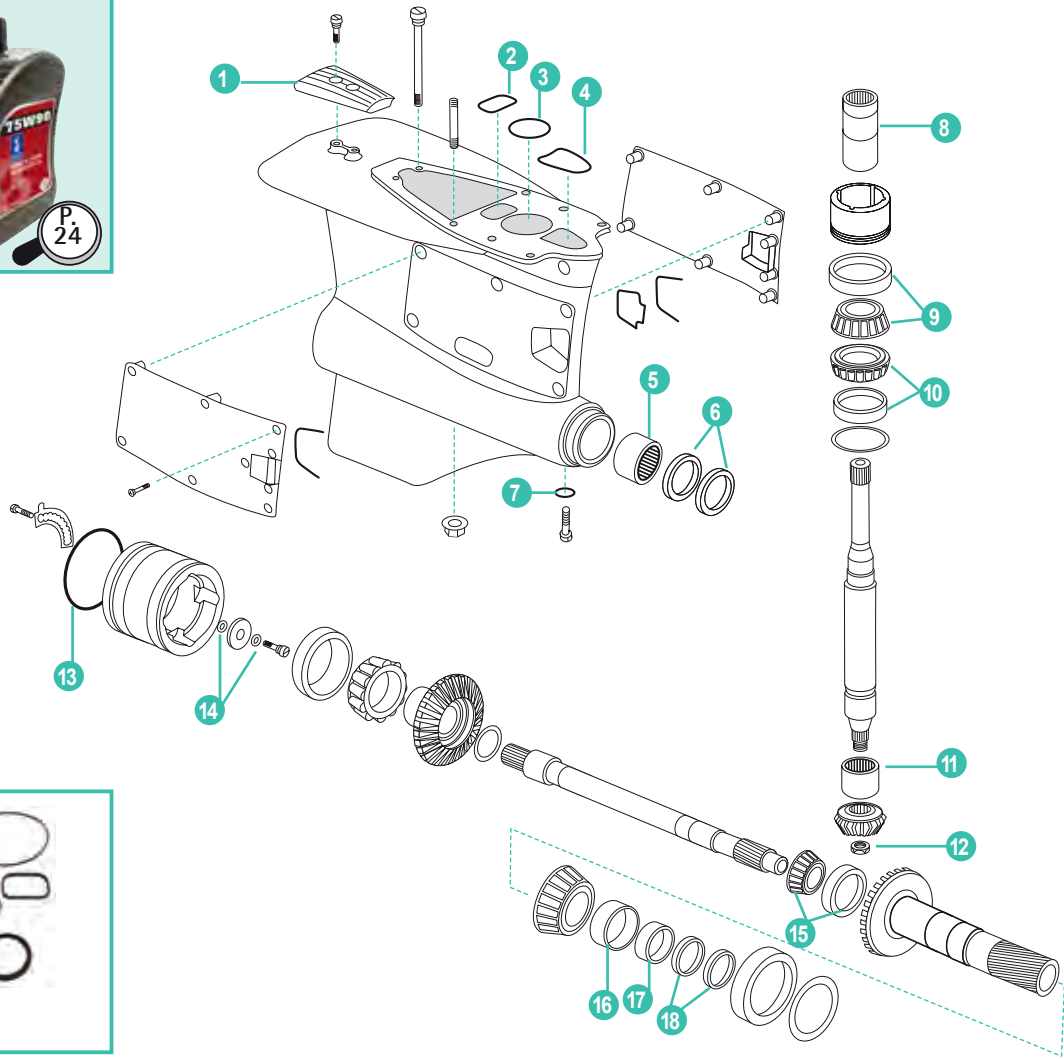

REF  
REC22612828

	REF	OEM				
1	REC3888814	3888814	ANODO Zn	ANODE Zn	ANODO Zn	ANODE Zn
	REC23164609AL	3888813	ÁNODO AI	ANODE AI	ANODO AI	ANODE AI
2	REC3889786	3889786	JUNTA	GASKET	GUARNIZIONE	JOINT
3	REC3852866	3852866	ARO TÓRICO	O-RING	O-RING	JOINT TORIQUE
4	REC22430456	22430456	JUNTA	GASKET	GUARNIZIONE	JOINT
5	REC183859	183959	COJINETE DE RODILLO	BEARING	CUSCINETTO	ROULEMENT A AIGUILLE
6	REC851407	851407	RETÉN	SEAL RING	O-RING TENUTA	JOINT SPI
7	REC3855081	3855081	ARO TÓRICO	O-RING	O-RING	JOINT TORIQUE
8	RM3852268	3852268	CASQUILLO ESTRIADO	SPLINED SLEEVE	CAPPUCCIO	MANCHON CANNELLÉ
9	REC31-86748A1	3854250	COJINETE DE RODILLO	BEARING	CUSCINETTO	ROULEMENT CONIQUE
10	REC31-66668A1	3854249	COJINETE DE RODILLO	BEARING	CUSCINETTO	ROULEMENT CONIQUE
11	REC184654	184654	COJINETE	BEARING	CUSCINETTO	ROULEMENT A AIGUILLE
12	REC852212	852212	TUERCA	NUT	DADO	ÉCROU
13	REC925259	925259	ARO TÓRICO	RUBER O-RING	FASCIA TONDA	JOINT TORIQUE
14	REC955893	955893	ARANDELA	WASHER	RONDELLA	RONDELLE
15	RM184691	184691	COJINETE RODILLO	BEARING	CUSCINETTO	ROULEMENT CONIQUE
16	REC184683	184683	ARO INTERIOR	CONE	O-RING INTERNO	JOINT TORIQUE
17	REC183272	183272	COJINETE	BEARING	CUSCINETTO	ROULEMENT A AIGUILLE
18	REC853808	853808	RETÉN	SEAL RING	ANELLO TENUTA	JOINT SPI
19	REC22612828	22612828	KIT REPARACIÓN	REPAIR KIT	KIT RIPARAZIONE	KIT JOINTS

PARTE INTERMEDIA  
AQUAMATIC

INTERMEDIATE HOUSING  
AQUAMATIC

PARTE INTERMEDIA  
AQUAMATIC

CARTER INTERMÉDIAIRE  
AQUAMATIC

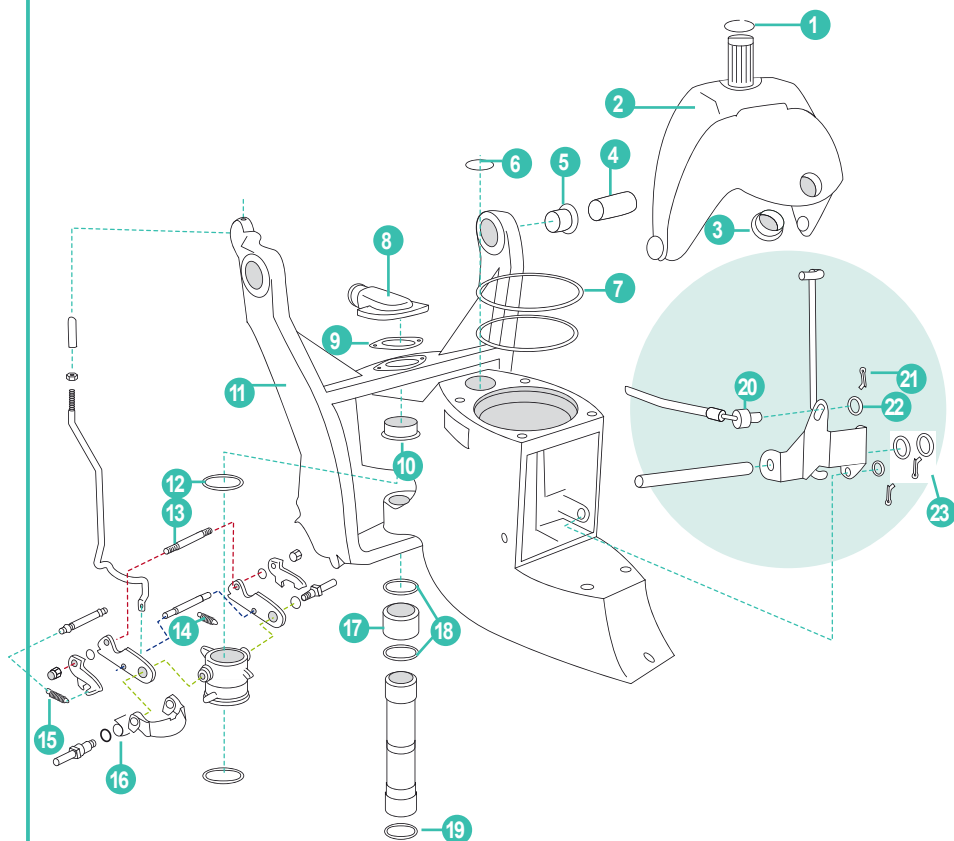

REF  
RM854133



REC75W90U3  
REC75W90U6

REF	OEM	INTERMEDIATE HOUSING	PARTE INTERMEDIA	CARTER INTERMÉDIAIRE	
1	REC839195 839195	RETEN BIELA (Horquilla estriada)	RING (Splined fork)	PARAOLIO BIELLA (Forcella filettata)	BAGUE DE DIRECTION (Fusée cannelée)
	RM977313 977313	RETEN BIELA (Horquilla cuadrada)	RING (Square fork)	PARAOLIO BIELLA (Forcella quadrata)	BAGUE DE DIRECTION (Fusée carrée)
2	RM873183 873183	HORQUILLA COLA	FORK	KIT FORCELLA PIEDE	KIT FUSEE DE DIRECTION
3	REC853048 853048	CASQUILLO	BUSHING	BOCCOLA	BAGUE
4	REC853175 853175	BULÓN	PIN	BULLONE	AXE PALIER
	REC876278 826341	CASQUILLOS HORQUILLA (AQ) CON TILT ELECTRICO	TILT BUSHINGS (AQ) WITH ELECTRIC TILT	BOCCOLA FORCELLA (AQ) CON TILT ELETTRICO	BAGUES (AQ) TILT ÉLECTRIQUE
5	REC832820 832820	CASQUILLOS HORQUILLA (AQ270T, 280T) CON POWER TRIM	TILT BUSHINGS (AQ270T, 280T) WITH POWER TRIM	BOCCOLA FORCELLA (AQ270T, 280T) CON POWER TRIM	BAGUES (AQ270T, 280T) POWER TRIM
	REC876279 853223	CASQUILLOS HORQUILLA (AQ290)	TILT BUSHINGS (AQ290)	BOCCOLA FORCELLA (AQ290)	BAGUES (AQ290)
	REC872096 872096	CASQUILLOS HORQUILLA (DP, DPD, DPE, DPG, DPH, DPX)	TILT BUSHINGS (DP, DPD, DPE, DPG, DPH, DPX)	BOCCOLA FORCELLA (DP, DPD, DPE, DPG, DPH, DPX)	BAGUES (DP, DPD, DPE, DPG, DPH, DPX)
6	REC125017 125017	ARO TÓRICO	O-RING	O-RING	JOINT TORIQUE
7	REC925259 925259	ARO TÓRICO	O-RING	O-RING	JOINT TORIQUE
	REC832846 851452	PIPETA TOMA AGUA (AQ270T, 280T) CON POWER TRIM	WATER OUTLET (AQ270T, 280T) WITH POWER TRIM	PIPETTA PRESA ACQUA (AQ270T, 280T) CON POWER TRIM	PIPE DE PRISE D'EAU (AQ270T, 280T) POWER TRIM
8	REC832846 854031	PIPETA TOMA AGUA (AQ200, 280) CON TILT Y AQ290	WATER OUTLET (AQ200, 280) WITH ELECTRIC TILT & (AQ290)	PIPETTA PRESA ACQUA (AQ200, 280) CON TILT E (AQ290)	PIPE DE PRISE D'EAU (AQ200, 280 AVEC TILT), AQ290
	REC872752 872752	PIPETA TOMA AGUA PLÁSTICO (DP, DPD, DPE, DPG, DPH, DPX)	WATER OUTLET-PLASTIC (DP, DPD, DPE, DPG, DPH, DPX)	PIPETTA PRESA ACQUA IN PLASTICA (DP, DPD, DPE, DPG, DPH, DPX)	PIPE DE PRISE D'EAU EN PLASTIQUE (DP, DPD, DPE, DPG, DPH, DPX)
9	REC814356 814356	JUNTA PIPETA	GASKET-WATER OUTLET	GUARNIZIONE PIPETTA	JOINT DE PIPE D'EAU
10	REC814388 814388	ARO TUBO AGUA (AQ250, 270, 280)	SWIVEL BUSHING WATER PIPE (AQ250, 270, 280)	O-RING TUBO ACQUA (AQ250, 270, 280)	JOINT TORIQUE (AQ250, 270, 280)
11	RM854100 854100	HORQUILLA COLA (SP-A, A1, A2, DP-A, A1, A2, 290A, B1, DA2)	FORK (SP-A, A1, A2, DP-A, A1, A2, 290A, B1, DA2)	KIT FORCELLA PIEDE (SP-A, A1, A2, DP-A, A1, A2, 290A, B1, DA2)	FOURCHE (SP-A, A1, A2, DP-A, A1, A2, 290A, B1, DA2)
12	REC814390 814390	ARANDELA PLÁSTICO	PLASTIC WASHER	RONDELLA PLASTICA	RONDELLE PLASTIQUE
13	REC814419 814419	EJE	SHAFT REVERSE LOCK	ASSE	ARBRE
14	REC832534 832534	MUELLE	SPRING REVERSE LOCK	MOLLA	RESSORT
15	REC814332 814332	MUELLE	SPRING REVERSE LOCK	MOLLA	RESSORT
16	REC814396 814396	MUELLE	SPRING REVERSE LOCK	MOLLA	RESSORT
17	REC183391 183391	COJINETE	BEARING	CUSCINETTO	ROULEMENT A AIGUILLE
18	REC181620 181620	RETÉN	SEAL	PARAOLIO	JOINT SPI
19	REC941820 941820	ARO TÓRICO	O-RING	O-RING	JOINT TORIQUE
20	REC22336734 22336734	CUBO	HUB	CUBO	CONNECTEUR CÂBLE COMMANDE
21	REC17276 17276	PIN	PIN	SPINOTTO	GOUPILLE
22	REC940191 940191	ARANDELA	WASHER	RONDELLA	RONDELLE
23	REC17253 17253	KIT PASADOR + ARANDELA	KIT PIN + WASHER	KIT PIN + RONDELLA	GOUPILLE FENDUE ET RONDELLE
24	REC23170 23170	KIT MUELLES COLA	SPRING SET	KIT MOLLE	KIT RESSORTS
25	RM854133 854133	GOMA PROTECTORA (AQ290 SP/DP)	TRANSOM SHIELD BUMPS (AQ290 SP/DP)	GOMMA (AQ290 SP/DP)	SILENT BLOC CAOUTCHOUC (AQ290 SP/DP)

VOLVO

RECAMBIO  
MARINOS

PARTE INTERMEDIA  
DP-E, DP-G, DP-C, DP-D

INTERMEDIATE HOUSING  
DP-E, DP-G, DP-C, DP-D

PARTE INTERMEDIA  
DP-E, DP-G, DP-C, DP-D

CARTER INTERMÉDIAIRE  
DP-E, DP-G, DP-C, DP-D

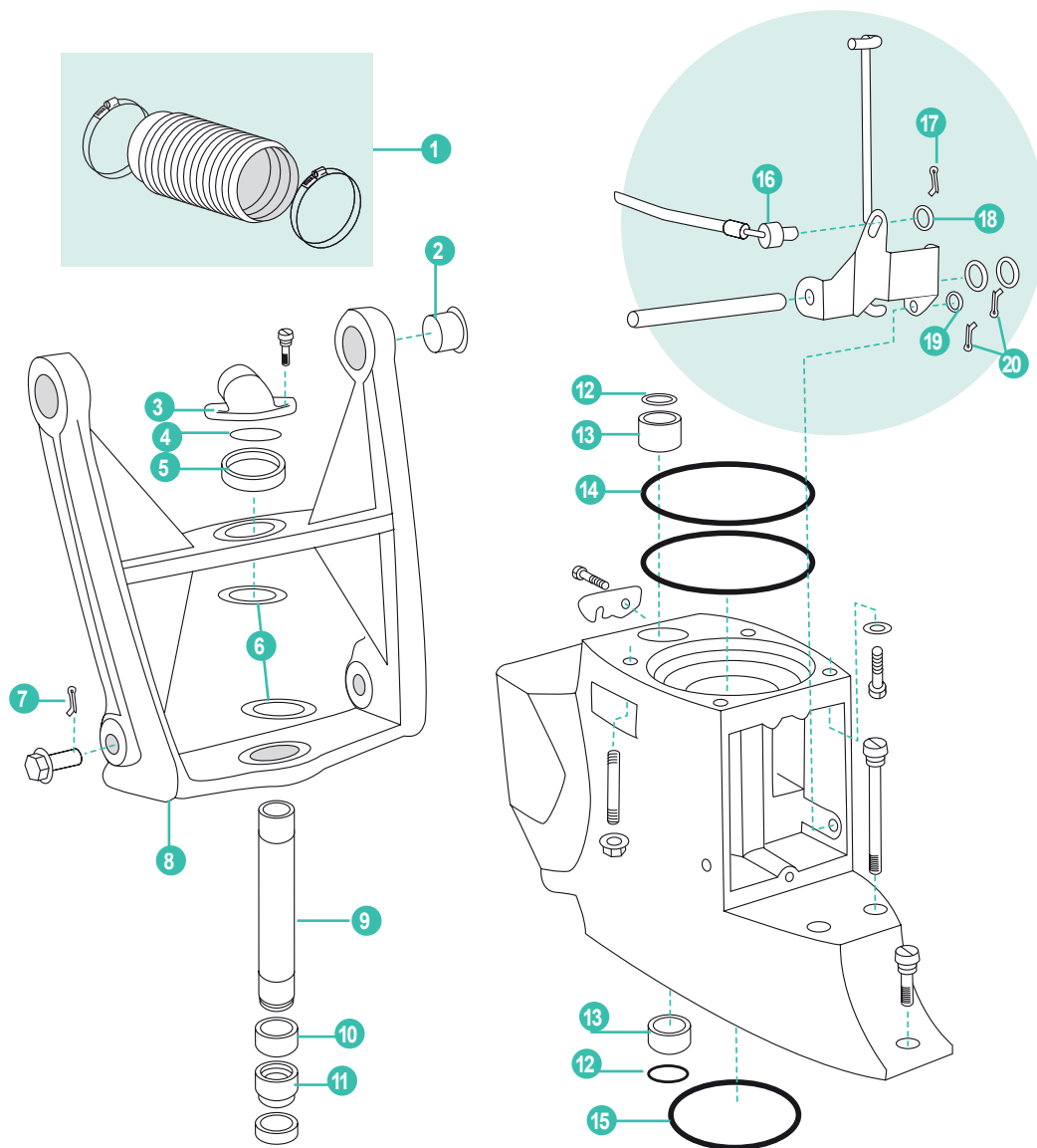

REF	OEM				
1	REC876631 876631	KIT DE FUELLE	BELLOW KIT	KIT CUFFIA	KIT SOUFFLET D'ÉCHAPPEMENT
2	REC872096 872096	KIT DE CASQUILLO	BUSHING KIT	KIT BOCCOLA	KIT BAGUE
3	REC872752 872752	PIPETA TOMA DE AGUA	PIPE CONNECTION	CONNESSIONE TUBO	PIPE D'EAU
4	REC979254 979254	ARO TÓRICO	O-RING	O-RING	JOINT TORIQUE
5	REC872756 872756	CASQUILLO COJINETE	BEARING BUSHING	BOCCOLA CUSCINETTO	BAGUE
6	REC3860808 3860808	ARANDELA	WASHER	RONDELLA	RONDELLE
7	REC967707 967707	PASADOR HENDIDO	PIN	PIN	GOUPILLE
8	REC3857140 3857140	HORQUILLA	SUSPENSION FORK	FORCELLA	FOURCHE
9	REC872753 872753	MANGUETA GUÍA	STEERING KNUCKLE	MANIGLIA DI GUIDA	FUSEE DE DIRECTION
10	REC872756 872756	CASQUILLO COJINETE	BEARING BUSHING	BOCCOLA CUSCINETTO	BAGUE ROULEMENT
11	REC873534 873534	SOPORTE	SUPPORT	SUPPORTO	SUPPORT
12	REC125017 125017	ARO TÓRICO	O-RING	O-RING	JOINT TORIQUE
13	REC872986 872986	MANGUITO	TUBE	TUBO	DURITE
14	REC925259 925259	ARO TÓRICO	O-RING	O-RING	JOINT TORIQUE
15	REC925256 925256	ARO TÓRICO	O-RING	O-RING	JOINT TORIQUE
16	REC22336734 22336734	CUBO	HUB	CUBO	CONNECTEUR CÂBLE DE COMMANDE
17	REC17276 17276	PASADOR HENDIDO	PIN	PIN	GOUPILLE
18	REC940191 940191	ARANDELA	WASHER	RONDELLA	RONDELLE
19	REC940191 940191	ARANDELA	WASHER	RONDELLA	RONDELLE
20	REC17253 17253	PASADOR HENDIDO	PIN	PIN	GOUPILLE FENDUE



ÁNODO ANODE ANODI ANODE

GUÍA GUIDE GUIDA GUIDE

			Zn	OEM	Al	OEM	
	<b>AQUAMATIC</b> 1 hélice Single prop drives 1 elica 1 hélice	ENGRANAJE INFERIOR LOWER GEAR INGRANAGGIO INFERIORE CARTER INFÉRIEUR	100	CMV-15	875810		
		200 - 290 SP	CMCMV-18	875815	CMCMV-18A		
PLACA / ALETA SPRAY PLATE PIASTRA / ALETTA PLAQUE / AILETTE		SX	REC3855411	3855411	REC3863193AL	3863193	
		SX-A	REC3888814	3888814	REC23164609AL	3888813	
<b>TRANSOM</b>			200-280	REC832598	832598	REC832598AL	
			290, SP	REC852835	852835	REC852835AL	
			SX	REC3854130	3854130	REC3586461AL	3586461
		SX-A	REC3888817	3841427	REC23164611AL	3888816	
<b>AQUAMATIC</b> 2 hélices Duoprop drives 2 eliche 2 hélices	ENGRANAJE INFERIOR LOWER GEAR INGRANAGGIO INFERIORE CARTER INFÉRIEUR	280, 290, DP	REC875821	875821	REC875821AL		
		DPS	REC3855411	3855411	REC3863193AL	3863193	
	PLACA / ALETA SPRAY PLATE PIASTRA / ALETTA PLAQUE / AILETTE	DPS-A, DPS-B, FWD	REC3888814	3888814	REC23164609AL	3888813	
		DPH	REC3588746	3588746	REC3588746AL	3588748	
		DPR	REC3888814	3589875	REC23164609AL		
		DPX	CM876638	876638			
	<b>TRANSOM</b>		280	REC832598	832598	REC832598AL	
			290, DP	REC852835	352835	REC852835AL	
			DPS	REC3854130	3854130	REC3586461AL	3586461
			DPS-A, DPS-B, FWD	REC3888817	3888817	REC23164611AL	3888816
		DPH, DPR	REC3588745	3588745	REC3588745AL	3588770	
	DPX	CM872139	872139	CM872139A			
<b>PENTA IPS</b>	ENGRANAJE INFERIOR LOWER GEAR INGRANAGGIO INFERIORE CARTER INFÉRIEUR		CM3593881	3593981	REC3593981AL		
	<b>TRANSOM IPS</b>	1			REC23172849AL	23172849	
		15, 2, 3, 30			CM40005875A	23172856	
<b>S-DRIVE</b>	ENGRANAJE INFERIOR LOWER GEAR INGRANAGGIO INFERIORE CARTER INFÉRIEUR	110S, 120S, MS25S	REC23172849	876286	REC23172849AL		
		130S, 150S (2 UN)	REC22651246	22651246	REC22651246AL		
<b>FOLDING PROPELLER</b>		2 PALAS / BLADES / PALE	REC3858399	3858399	REC3858399AL		
	<b>S-DRIVE</b>	3 PALAS / BLADES / PALE	REC3858399	3858399	REC3858399AL		
		4 PALAS / BLADES / PALE	TEN00728BIS	3584442			
	<b>EJE SHAFT ASSE</b>	4 PALAS / BLADES / PALE	TEN00728BIS	3584442			

ÁNODO

ANODE

ANODI

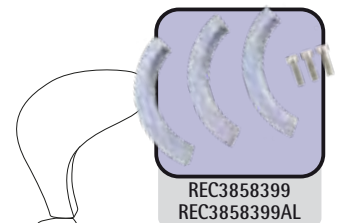
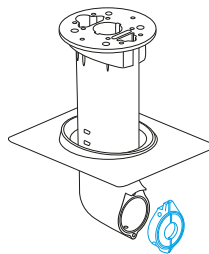

ANODE



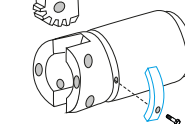



	PLACA PLATE PIASTRA PLAQUE	TRANSOM	HÉLICE PROPELLER ELICA HELICE	COLECTOR MANIFOLD COLLETORE COLLECTEUR
280		REC832598 REC832598AL		
280 DP			REC875821 REC875821AL	
290		REC872793 REC872793AL		
290 DP, DPX, DP-E, DP-C1, CP-D1		REC852835 REC852835AL	REC875821 REC875821AL	
DP-SM			REC875821 REC875821AL	
SX-M, DP-SM	REC3855411 REC3863193AL	REC3854130 REC3586461AL REC873395 REC873395AL		
SX-A, DPS-A		REC23164611AL		
DPH, SX-A, SX-D, FWD	REC3888814 REC23164609AL			
DPH, DPR	REC3588746 REC3588746AL	REC3588745 REC3588745AL		
IPS		REC23172849 REC23172849AL	REC3593981 REC3593981AL	
VELEROS   SAILBOATS   VELA   VOILIER			REC22651246 REC22651246AL	
V6 Et V8				REC21403633







REF	OEM		
Zn REC21403633	21403633	V6 Et V8	

		OEM	
ZN REC3854130	(kg) 3854130	3854130	
AL REC3586461AL	(kg) 3586461	3586461	



		OEM	
ZN REC873395	(kg) 873395	873395	
AL REC873395AL	(kg) 873395	873395	



		OEM	
ZN REC872793	(kg) 872793	872793	
AL REC872793AL	(kg) 872793	872793	



		OEM	
ZN REC3888814	(kg) 3888814	3888814	
AL REC23164609AL	(kg) 23164609	23164609	



		OEM	
ZN REC3588746	(kg) 3588746	3588746	
AL REC3588746AL	(kg) 3588746	3588746	

REF	OEM		
Al REC23164611AL	23164611	SX-A DPS-A	
Zn REC3888817	3888816 3888817		



REF	OEM		
ZN REC3589875	3589875	(kg) 0,82	
AL REC3589876AL	3589876	(kg) 0,82	

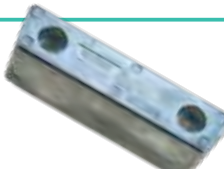

REF	OEM		
ZN REC876638	876638	(kg) 0,22	DPX
AL REC876638AL	876638	(kg) 0,22	DPX

REF	OEM		
ZN REC855105	855105	(kg) 0,63	S. DRIVE
AL REC855105AL	855105	(kg) 0,63	S. DRIVE



		OEM	
ZN REC3588745	(kg) 3588745	3588745	
AL REC3588745ALL	(kg) 3588745	3588745	



		OEM	
ZN REC852835	(kg) 852835	852835	
AL REC852835AL	(kg) 3588770	3588770	



		OEM	
ZN REC832598	(kg) 832598	832598	
AL REC832598AL	(kg) 832598	832598	



		OEM	
ZN REC23172849	(kg) 23172849	23172849	
AL REC23172849AL	(kg) 23172849	23172849	

REF	OEM		
ZN REC3852970	3852970	(kg) 0,16	SX DRIVE
AL REC3852970AL	3852970	(kg) 0,16	SX DRIVE

REF	OEM		
ZN REC872139	872139	(kg) 0,69	DPX
AL REC872139AL	872139	(kg) 0,69	DPX

REF	OEM		
ZN REC832934	832934	(kg) 0,63	TRIM 270
AL REC832934AL	832934	(kg) 0,63	TRIM 270

REF	OEM		
ZN REC852019	852019	(kg) 0,04	SAIL DRIVE 100
AL REC852019AL	852019	(kg) 0,04	SAIL DRIVE 100



REF	OEM		
ZN REC41100276	41100276	(kg) 0,05	
AL REC41100276AL	41100276	(kg) 0,05	

REF	OEM	 (kg)	
ZN REC21868042	21868040	0,45	D4/D6 Exhaust pipe
AL REC21868042AL	21868042	0,18	DP4 / DPR / DPI





REF	OEM	 (kg)
ZN REC41100098	41100098	0,06
AL REC41100098AL		





REF	OEM	 (kg)	
ZN REC3861636	3861636	0,24	XDP-B
AL REC3861636AL			





REF	OEM	 (kg)	
ZN REC3807400	3807400	0,43	DPH - DPR
AL REC3807400AL			





REF	OEM	 (kg)	Ø (mm)
ZN REC833913	833913	0,31	25-30
ZN REC833915	833915	0,51	35-40
ZN REC828140	828140	0,46	45
ZN REC873413	873413	0,43	35-40





REF	OEM	 (kg)	
ZN REC852018	852018	0,18	110, 120, S-B, S-C
AL REC852018AL			



REF	OEM	 (kg)
ZN REC3593981	3593981	
AL REC3593981AL		



REF	OEM	 (kg)
ZN REC3855411	3855411	
AL REC3863193AL	3863193	





REF	OEM	 (kg)	
ZN REC875815	875815	0,76	280-290
AL REC875815AL			





REF	OEM
AL REC876286AL	





REF	OEM	 (kg)
ZN REC22651246	22651246	
AL REC22651246AL		



REF	OEM	 (kg)
ZN REC875821		
AL REC875821AL		



REF	OEM	 (kg)	
ZN REC875812	875812	0,94	S. DRIVE 110
AL REC875812AL			



REF	OEM	Ø	 (kg)	
ZN REC875810	875810	100 mm	0,20	
AL REC875810AL				
ZN REC875809	875809	108 mm	0,26	50-100 HP
AL REC875809AL				
ZN REC875805	875805	114 mm	0,28	
AL REC875805AL				







REF	OEM	(kg)	XDP-B
ZN REC3861634	3861634	0,30	
AL REC3861634AL			



(kg)	OEM
ZN REC3858399	3858399
AL REC3858399AL	



REF	OEM
ZN REC3888491	
AL REC23974207AL	









REF	OEM	Ø EXT	(kg)	SAIL DRIVE
ZN REC3584442	3584442	97,5 mm	0,28	
AL REC2394207AL				



	INTERCAMBIADOR EXCHANGER SCAMBIATORE ECHANGEUR	BLOQUE BLOCCO MOTEUR	CULATA CYLINDER HEAD TESTATA CULASSE	INVERSOR INVERTITORE INVERSEUR
D13/ D12/ D16 MD/ TMD/ TAMD 60/ 70/ 100/ 102/ 122/ 162/ 163/ 165	REC823661 REC823661AL			
D4/ D5/ D6/ D7/ D8/ D9/ D11/ D12 MD, TMD, TAMD, AQAD, AQ 21/30/31/40/41 /42/60/61/63/70/71/72 /73/74/100/120/122/162/165	REC838929 REC838929AL			
2003		REC838929 REC838929AL		
2001-2002			REC838929 REC838929AL	
MS3				REC838929 REC838929AL



KITS ANODOS	ANODES KIT	KIT ANODI	KIT ANODES																
<table border="1"> <thead> <tr><th>REF</th></tr> </thead> <tbody> <tr><td>Zn RECKITVSXZN</td></tr> <tr><td>AL RECKITVSXAL</td></tr> <tr><td>Mg RECKITVSXM</td></tr> </tbody> </table> 	REF	Zn RECKITVSXZN	AL RECKITVSXAL	Mg RECKITVSXM	<table border="1"> <thead> <tr><th>REF</th></tr> </thead> <tbody> <tr><td>Zn RECKITV290ZN</td></tr> <tr><td>AL RECKITV290AL</td></tr> <tr><td>Mg RECKITV290M</td></tr> </tbody> </table> 	REF	Zn RECKITV290ZN	AL RECKITV290AL	Mg RECKITV290M	<table border="1"> <thead> <tr><th>REF</th></tr> </thead> <tbody> <tr><td>Zn RECKITV290DPZN</td></tr> <tr><td>AL RECKITV290DPAL</td></tr> <tr><td>Mg RECKITV290DPM</td></tr> </tbody> </table> 	REF	Zn RECKITV290DPZN	AL RECKITV290DPAL	Mg RECKITV290DPM	<table border="1"> <thead> <tr><th>REF</th></tr> </thead> <tbody> <tr><td>Zn RECKITV280ZPN</td></tr> <tr><td>AL RECKITV280ZPAL</td></tr> <tr><td>Mg RECKITV280ZPM</td></tr> </tbody> </table> 	REF	Zn RECKITV280ZPN	AL RECKITV280ZPAL	Mg RECKITV280ZPM
REF																			
Zn RECKITVSXZN																			
AL RECKITVSXAL																			
Mg RECKITVSXM																			
REF																			
Zn RECKITV290ZN																			
AL RECKITV290AL																			
Mg RECKITV290M																			
REF																			
Zn RECKITV290DPZN																			
AL RECKITV290DPAL																			
Mg RECKITV290DPM																			
REF																			
Zn RECKITV280ZPN																			
AL RECKITV280ZPAL																			
Mg RECKITV280ZPM																			
<table border="1"> <thead> <tr><th>REF</th></tr> </thead> <tbody> <tr><td>Zn RECKITV280ZPN</td></tr> <tr><td>AL RECKITV280ZPAL</td></tr> <tr><td>Mg RECKITV280ZPM</td></tr> </tbody> </table> 	REF	Zn RECKITV280ZPN	AL RECKITV280ZPAL	Mg RECKITV280ZPM	<table border="1"> <thead> <tr><th>REF</th></tr> </thead> <tbody> <tr><td>Zn RECKITV280ZPN</td></tr> <tr><td>AL RECKITV280ZPAL</td></tr> <tr><td>Mg RECKITV280ZPM</td></tr> </tbody> </table> 	REF	Zn RECKITV280ZPN	AL RECKITV280ZPAL	Mg RECKITV280ZPM										
REF																			
Zn RECKITV280ZPN																			
AL RECKITV280ZPAL																			
Mg RECKITV280ZPM																			
REF																			
Zn RECKITV280ZPN																			
AL RECKITV280ZPAL																			
Mg RECKITV280ZPM																			

ÁNODO

ANODE

ANODI



ANODE

REF	OEM	 (kg)	
ZN TEN00717	872793	0,11	DUO PRO 290





REF	OEM	 (kg)	
ZN TEN00707	832598	0,93	250, 270, 275, 280, 285



REF	OEM	 (kg)	
ZN TEN00708	852835	0,75	DUO PRO 290





REF	OEM	 (kg)	
ZN TEN00718	3854130	1,05	S. DRIVE - SX DRIVE



REF	OEM	 (kg)	
ZN TEN00732	4100276	0,09	



REF	OEM	 (kg)	
ZN TEN00722	873395	0,37	DPX
AL TEN00722AL			





REF	OEM	 (kg)	
ZN TEN00733	3588746 3588748 3588750	0,85	DPH DPR
ZN TEN00733BIS	3888814	1,27	SXA DPS-A





REF	OEM	 (kg)	
ZN TEN00739AL	40005875	1,60	IPS





REF	OEM	Ø EXT	 (kg)	
ZN TEN00728	3858399	83 mm	0,30	SAIL DRIVE





REF	OEM	 (kg)	
ZN TEN00735	3888814	0,52	DUO PROP





REF	OEM	 (kg)	
ZN TEN00737	3888817	1,15	SXA APS-A

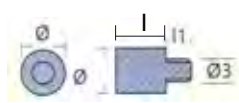

REF	OEM	 (kg)	l (mm)	l1 (mm)	Ø (mm)	Ø3
ZN TEN00715	838929	0,02	13	10	16	5/16"

REF	OEM	 (kg)	
ZN TEN00738	3599981	0,74	IPS



REF	OEM	 (kg)	Ø (mm)
AI TEN00719	833913	0,31	25-30
ZN TEN00719-1		0,31	
AI TEN00720	833915	0,28	35-40
ZN TEN00720-1		0,51	
AI TEN00721	828140	0,49	45
ZN TEN00721-1		0,46	
ZN TENWE724	873413	0,43	35-40



REF	OEM	(kg)	
ZN TEN00706	876286 851983	0,53	S. DRIVE 120



REF	OEM	(kg)	
ZN TEN00704BIS	875821	0,47	DUO PRO 290 (2002+)



REF	OEM	(kg)	
ZN TEN00726	3855411	0,94	SX DRIVE
AL TEN00726AL			



REF	OEM	(kg)	
ZN TEN00734	3888305 3888306	1,46	SAIL DRIVE SD 130 - 150 (2002-03)



**KITS DE ÁNODOS ANODES KIT KIT ANODI KIT ANODES**

KIT	ÁNODO ZN ZN ANODE ANODO ZN ANODE ZN	OEM	TAPÓN PLUG TAPPO BOUCHON	(kg)	L (mm)	A (mm)	B (mm)	C (mm)	D (mm)	M BSPT	M2 M2	M2 UNIC
TEN00714T	TEN00714	838929	TEN00714TPM	0,08	85	13	30	15	10	1/2"	M8	7/16"
	TEN00714-1		TEN00714TPF	0,04 0,02 0,06 0,06								



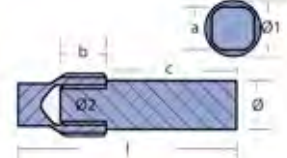

KIT	ZN	OEM		(kg)	L (mm)	A (mm)	B (mm)	C (mm)	Ø BSPT	Ø	Ø2 UNIC					
TEN00713T	TEN00713	832989	TEN00713TP	0,10	67	13	10	40	1/2"	15	7/16"	200				
			TEN00713TP	0,06									40	15	7/16"	250
			TEN00713TP	0,40									13	10	1/2"	270

KIT	ZN	OEM		(kg)	A (mm)	Ø1 (mm)	L (mm)	B (mm)	Ø	Ø2	Ø4 UNIC					
TEN00716T	TEN00716	823661	TEN00716TP	0,16	19	40	61	19	44	25	3/8"					
			TEN00716TP	0,26								10	44	16	25	3/8"
			TEN00716TP	0,10								19	40	61	19	44



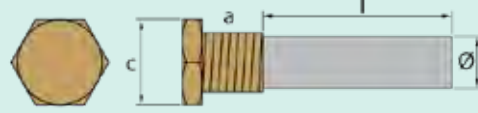

KIT	OEM	(kg)	A	c	l	Ø
ZN TEN02029T	3858995	0,07	3/8"	19	38	12,5

new

VOLVO

RECAMBIOS  
MARINOS

REF   
ZN TENKITVOLV0280 280



REF   
ZN TENKITVOLV0290 290



REF   
ZN TENKITVOLV0290-C 290



REF   
ZN TENKITVOLV0ELICA3PAL ELICA 3 PALE



REF   
Zn TENKITVOLVODP280 DUO PRO 280



REF   
ZN TENKITVOLV0IPS IPS



REF   
Zn TENKITVOLVODP290 DUO PRO 290



REF   
ZN TENKITVOLV0SX SX



REF   
ZN TENKITVOLVODP290-C DUO PRO 290-C



REF   
ZN TENKITVOLV0SXA/DPASA SXA / DPASA



REF   
ZN TENKITVOLVODPH/DPR DPH/DPR



REF   
ZN TENKITVOLV0XDP-B XDP-B







ÁNODO

ANODE

ANODI

ANODE

REF	OEM	(kg)	
ZN CM875812	875812	0,92	110S
AI CM875812A		0,41	



REF	OEM	(kg)	
ZN CMV-17	875805	0,29	AQ250, 270, 270T, 275, 275A SP-A/MT, A1, A2
AI CMV-17A		0,13	



REF	OEM	(kg)	
ZN CM851983	876286	0,49	110S, 120S, SB, M525S
AI CM851983A		0,24	



REF	OEM	(kg)	
ZN CMCMV-18	875815	0,73	AQ280, L, T, PT AQ285A, 290, 290A
AI CMCMV-18A		0,29	



REF	OEM	(kg)	
ZN CM3888305	3888305	1,48	130S, 150S
AI CM3888305A		0,20	



REF	OEM	(kg)	
ZN CM875821	875821	0,92	DUOPROP, DP-A, A1, A2, B1, C, D
AI CM875821A		0,41	



REF	OEM	(kg)	
ZN CM22651246	22651246 23615636	1,48	Sail Drive New version



REF	OEM	(kg)	
ZN CM832598	832598	0,95	AQ250, 270, 275, 280, 280DP, 280DPT
AI CM832598A		0,37	



REF	OEM	(kg)	
ZN CMV-16	875809	0,20	50, 200



REF	OEM	(kg)	
ZN CM852835	852835	0,76	SP, DP
AI CM852835A		0,30	



REF	OEM	(kg)	
ZN CMV-15	875810	0,20	50, 100



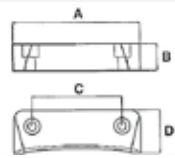

REF	OEM	(kg)		A (mm)	B (mm)	C (mm)	D (mm)
ZN CM3588745	3588745	0,49	DPH, DPR	120	24	86	40
AI CM3588745A		0,20					







REF	OEM	KG (kg)		
ZN CM872139	872139	0,65		DPX
AI CM872139A		0,29		



REF	OEM	KG (kg)		
ZN CM385411	385411	1,04		SX, DPS
AI CM385411A		0,41		





REF	OEM	KG (kg)		
ZN CM3841427	3888817	0,43		SX-A, DPS-A, B
AI CM3841427A	3888816	0,20		FWD





REF	OEM	KG (kg)		
ZN CM872793	872793	0,11		SP, DP
AI CM872793A		0,05		



REF	OEM	KG (kg)		
ZN CM3883728	3888813	1,08		SX-A, DPS-A, B
AI CM3883728A		0,20		FWD





REF	OEM	KG (kg)		
ZN CM855105	855105	0,16		50S





REF	OEM	KG (kg)		
ZN CM3852970	3852970	0,15		SX-C
AI CM3852970A		0,07		



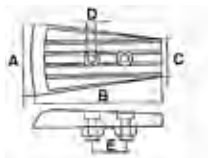

REF	OEM	KG (kg)			A (mm)	B (mm)	C (mm)	D (mm)	E (mm)
ZN	3588746	0,71		DPH	78	130	49	8,5	35
AI		0,35							







REF	OEM	KG (kg)		
ZN CM3861634	3861634	0,29		XDP
AI CM3861634A		0,13		





REF	OEM	KG (kg)		
ZN CM3854130	3854130	1,09		SX, SXA, DPS
AI CM3854130A		0,41		





REF	OEM	KG (kg)		
ZN CM3861636	3861636	0,24		XDP
AI CM3861636A		0,10		





REF	OEM	KG (kg)		
ZN CM852018	852018	0,05		
AI CM852018A		0,03		



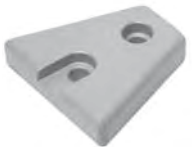

REF	OEM	KG (kg)		
ZN CM876638	876638	0,04		DPX





REF	OEM	KG (kg)		
ZN CM852019	852019	1,09		



REF	OEM	KG (kg)		
ZN CM873395	873395	0,28		SX-MHP
AI CM873395A		0,13		



REF	OEM	KG (kg)		
ZN CM832934	832934	0,66		270



REF	OEM	(kg)	IPS
ZN CM3593881	3593981	0,69	IPS
AL CM3593881A		0,29	



REF	OEM	(kg)	rosca
ZN TEN00719-1	873411	0,30	22 - 25 mm
ZN CM873412	873412	0,28	30 mm
ZN CM828140	873413	0,54	40 - 45 mm



REF	OEM	(kg)	27 x 52 mm
ZN CM41100276	41100276	0,09	



REF	OEM	(kg)	IPS
ZN CM40005875	40005875	3,61	IPS
AL CM40005875A		1,51	

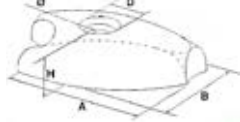

REF	OEM	(kg)	A (mm)	B (mm)	H (mm)	D (mm)	Ø (mm)
ZN CM41100276P	41100276	0,04	37	22	15	10	65

REF	OEM	(kg)	Active corrosion EVC
ZN CM40005206	40005206		Active corrosion EVC
AL CM40005206A			



REF	OEM	(kg)	XDP
ZN CM823661	823661	0,14	XDP
AL CM823661A		0,07	



REF	OEM	(kg)	XDP
ZN CM838929	838929	0,05	XDP
AL CM838929A		0,02	



REF	OEM	(kg)	D4/D6 Exhaust pipe DPH/DPR/DPI
ZN CM21718129	21868042		D4/D6 Exhaust pipe DPH/DPR/DPI
AL CM21718129A	21718129		



REF	OEM	(kg)
ZN CM41100098	41100098	0,06



### KITS DE ÁNODOS

### ANODES KIT

### KIT ANODI

### KIT ANODES

REF	OEM
ZN CM3858399	3858399
AL CM3858399A	



REF	290 DP
MG CM290DPKITM	
AL CM290DPKITA	

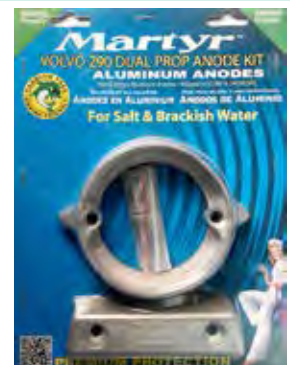

REF	
MG CM280KITM	280 SP
AL CM280KITA	



REF	
MG CMSXKITM	SX
AL CMSXKITA	



REF	
MG CM290KITM	290 SP
AL CM290KITA	



REF	
MG CMSXAKITM	SX-A
AL CMSXAKITA	



REF	
MG CM280DPKITM	280 DP
AL CM280DPKITA	

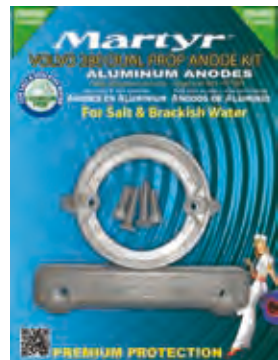

REF	
MG CMDPHKITM	DPH
AL CMDPHKITA	



KITS REPARACIÓN

REPAIR KITS

KIT RIPARAZIONE

KIT DE RÉPARATION

AQUAMATIC

ARO TOMA AGUA

SWIVEL BUSHING FOR PIPE

BOCCOLA

BAGUE

REF	OEM	
REC814388	814388	250, 270, 280



CASQUILLOS HORQUILLA

PLASTIC BUSHINGS

BOCCOLA FORCELLA

BAGUES DE CASQUE

REF	OEM	
REC876278	826341	Tilt eléctrico Electric Tilt Tilt elettrico Tilt électrique



REF	OEM	
REC876279	876279 853223	Power Trim AQ290, SP, DP



REF	OEM	
REC832820	832820	Power Trim AQ270T, 280T



REF	OEM	
REC872096	876507 872096	Power Trim DPE DPX, -S1 DP-C1, D1





PIPETA TOMA AGUA		HOSE CONNECTOR		PIPETTA		PIPE D'EAU		
REF	OEM			REF	OEM			
REC854031	854031	280	REC814356	REC872752	872752	DP, D, E, G, H, X	Plástico   plastic in plastica   plastique REC979254	
								
REF	OEM			REF	OEM			
REC832846	832846	AQ200-290 AQSP, DP	REC814356	REC40005192	40005192	DPH-A, B, C DPR-A, B, C	REC990899	
								
JUNTA GOMA		RUBBER GASKET		GUARNIZIONE IN GOMMA		JOINT CAOUTCHOUC		
REF	OEM			REF	OEM			
REC814356	814356			REC979254	979254			
REF	OEM							
REC990899	990899							
ARANDELA DE PLÁSTICO		PLASTIC WASHER		RONDELLA IN PLASTICA		RONDELLE EN PLASTIQUE		
REF	OEM			REF	OEM			
REC814390	814390			REC850888	850888	AQ200, 250, 270, 275, 280, 285, 290 SP-A, A, MT, A1, A2, C, C1		
PASADOR		SETTING PIN		CHIAVISTELLO		ARBRE		
REF	OEM		REF		OEM			
REC814301	814301			REC814419	814419	AQ290, A DP, A, A1, A2, B1 SP-A, A1, A2		

MUELLES

SPRINGS

MOLLE

RESSORTS

REF	OEM	
REC23170		KIT
REC832534	832534	
REC814396	814396	
REC814332	814332	



REC23170



REC832534



REC814396



REC814332

ARANDELA SEGURO TUERCA

PROP LOCK TAB WASHER

RONDELLA DI SICUREZZA

RONDELLE FREIN

REF	OEM	
REC897367	897367	AQ200, 250, 270, 275, 280, 285, 290 SP-A, A, MT, A1, A2, C, C1



CORTALÍNEAS

THRUST RING

REGGISPINTA

COUPE FILS

REF	OEM	
REC839423	839423	280-290 SP, 285
REC872082	872082	SP-E, A2
REC839534	839534	250, 270, 275



REC839423



REC872082



REC839534

TORNILLO

SCREW

VITE

VIS

REF	OEM	
REC850889	850889	289/290 SP



GRUESO TRASERO HÉLICE DP

THRUST WASHER DP

SPESSORE POSTERIORE ELICA DP

ENTRETOISE ARRIÈRE DP

REF	OEM	
REC3858457	3858457	DP-E, G, C1, D1
	3856070	
	872891	
REC3858458	852206	
	3858458	
	3857307	
	3856069	
872872		



REC3858457



REC3858458

KIT REPARACION HELICE

PROPELLER SERVICE KIT

KIT RIPARAZIONE ELICA

KIT CONE HELICE

REF	REF	OEM
	REC854045	854045
	REC854047	854047
REC23120	REC897367	897367
	REC850888	850888
	REC850889	850889



REC854047



REC850888



REC850889



REC897367



REC854045

REF	OEM	
RM872614	872614	DP 16mm
	854057	
	854666	
	853655	
RM872549	872549	DP 20 mm



RM872614



RM872549

SX

**TOPE HÉLICE**      **SPLINE WASHER**      **SPESSORE ELICA**      **ENTRETOISE**

REF	OEM
REC3852350	3852350



**CIERRE HÉLICE**      **THICK THRUST WASHER**      **CHIUSURA ELICA**      **RONDELLE D'HELICE**

REF	OEM	
REC126870	3852020	



**PASADOR**      **COTTER PIN**      **COPPIGLIA**      **GOUILLE FENDUE**

REF	OEM	
REC3852056	3852056	



**KIT REPARACION HELICE**      **PROPELLER SERVICE KIT**      **KIT RIPARAZIONE ELICA**      **KIT CONE HELICE**

REF	OEM	ROSCA
REC398042	3850984	3/4x16
REC22188	3850984	
REC22189	3850984	



**KITS REPARACIÓN COLAS E INVERSORES**      **GASKET SET STERN DRIVES & INVERTERS**      **KITS RIPARAZIONE PIEDI E INVERTITORI**      **KITS RÉPARATION EMBASES ET INVERSEURS**

**KITS COMPLETOS**      **FULL KIT**      **KIT COMPLETO**      **KIT COMPLET**

REF	OEM		
REC19035			AQ Drives. DP-C1, D1, E DPX-S, S1



REF	OEM		
REC876391	876391 875720		120C, D, S, B S120C





REF	OEM	
REC875741	876266+876267 875741	AQ 250, 270, 275, 280, 285, 290 (Con carcasa inferior DP with DP lower housing con carcassa inferiore DP avec carter inférieur DP) DP-A, A1, B, C, D





REF	OEM	
REC23027		DPH-D DPR-D





REF	OEM	
REC19037	876266+876268	 DP AQ 200, 250, 270, 275, 280, 285, 290 SP-A, MT, A1, A2, C



REF	OEM	
REC3859050	3859050	XDP-B X-B, BLT XHP-BLT XXP-A, ALT, D3



REF	OEM	
REC23009		DPH-A, B, C DPR-A, B, C



REF	OEM	
REC877362	21389074	



**new**

REF	OEM		OEM
REC21112497	21112497	SAIL 130/150	3586693 GASKET
			976994 O-RING
			925256 O-RING
			944364 O-RING
REC21112496	21112496	SAIL 120	3856834 GASKET
			852668 WIRE LOCKING
			925256 O-RING

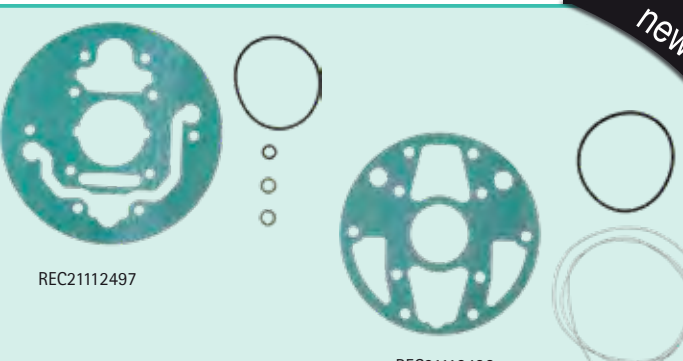

REC21112497

REC21112496

**new**



**KIT INFERIOR**

**LOWER KIT**

**KIT INFERIORE**



**KIT INFÉRIEUR**

REF	OEM	
REC876267		DP-C1, D1, E DPX-S, S1



REF	OEM	
REC23018		DPH-A, B, C DDPR-A DPR-B, C



REF	OEM	
REC22086		 DP AQ 250, 270, 275, 280, 285, 290 SP-A, MT, A1, A2, C, C1

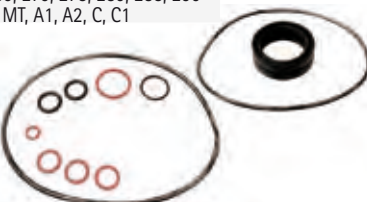

REF	OEM	
REC23553896	23553896	DPH/DPR (D-E) DPI-A

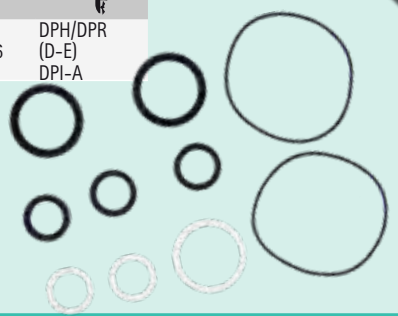



**new**

REF	OEM	
REC22087		DP-A, A1, A2, B, B1, C, C1, D, D1 DPX-S, S1 Eje hélice   Drives shaft   Asse elica   Arbre d'hélice





REF	OEM	
REC23033		130S-A, S-B, R-A, R-B 150S-A, S-B, R-A, R-B



REF	OEM	
REC876268	876268	AQ 200, 250, 270, 275, 280, 285, 290, SP-A, A/MT, A1, A2, C



REF	OEM		OEM	
REC22151	200, 250, 270, 275, 280, 290 SP-A, C		REC125017	125017
			REC839253	839253
			REC925256	925256
			REC925259	925259
			REC955974	955974
			REC956000	956000



REF	OEM	
REC876267	876267	AQ280DP, 290DP DP-A, A1, A2, B1, C, D



REF	OEM	
REC3812357	3812357	IPS-A, B, C, D, E, F



**new**

**KIT INFERIOR- EJE HÉLICE**    **LOWER KIT - SHAFT PROPELLER**

REF	OEM	
REC22085	120C-D, S, S-B S120C	



**KIT INFERIORE - ASSE ELICHA**    **KIT INFÉRIEUR - ARBRE D'HÉLICE**

REF	OEM	
REC23008	120S-E MS25S-A, R-A	





**KIT INFERIOR DP**    **LOWER KIT DP**

REF	OEM	
REC3856002	3856002	DP-CS, S1, SM



**KIT INFERIORE DP**    **KIT INFÉRIEUR DP**

REF	OEM	
REC23020	3888822	DPS-A, B



REF	OEM	
REC3855275	3855275	SX-C, C1, C2, CT, CTI, R, RTI, M, MI, MTD



REF	OEM	
REC23025		XDP-B, X-B, X-BTL, XHP, BLT, XXP-A, XXP-ALT, XXP-D3

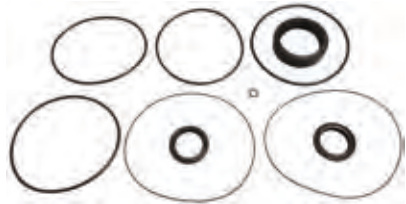

REF	OEM	
REC23022	3888821	SX-A



REF	OEM	
REC22612828	22612828	FWD



**KIT SUPERIOR**    **UPPER KIT**

REF	OEM	
REC876266	876266	DP-CS, SAQ 250, 270, 275, 280, 285, 290 SP-A, A/MT, A1, A2, C, DP-A, A1, A2, B1, C, D



**KIT SUPERIORE**    **KIT SUPÉRIEUR**

REF	OEM	
REC22151		AQ270, 270T, 275, 275A, 280, 280DP, 280T, 285A, 290, 290A, 290DP SP-A, A/MT, A1, A2, C, C1 DP-A, A1, A2, B, B1, C, C1, D, D1, E DPX, S



REF	OEM	Icon
REC19029	DPX-, S, S1 SP-C1 DP-C1, D1, E, S1	

REF	OEM	Icon
REC3888917	3888917 876392	

SX-A  
DPS-A, B, B1  
FWD

REF	OEM	Icon
REC3850594	3850594	

SX-C, C1, C2, CT, CT1, R, RT1, RT2, M, MTD, M1  
DPS, SM

REF	Icon
REC23010	

DPH-A, B, C, D, D1  
DDPR-A  
DPRB, C, D

REF	Icon
REC22097	

120C-D, S, S-B  
S120C

REF	Icon
REC23019	

DPH-A, B, C, D  
DDPR-A  
DPRB, C, D

REF	Icon
REC23024	

XDP-B  
X-B, BLT  
XHP-BLT  
XXP-A, ALT, D3

REF	Icon
REC23034	

DP-G  
DPX-A

**KIT INVERSORES      INVERTERS KIT      KIT INVERTITORI      KIT INVERSEURS**

REF	OEM	Icon
REC876588	876588	

HS1

REF	OEM	Icon
REC876073	876073	

MS4

**KIT TUERCA EJE AQUAMATIC      SHAFT NUT KIT AQUAMATIC      KIT DADO ASSE AQUAMATIC      KIT ÉCROU D'ARBRE AQUAMATIC**

REF	OEM
REC906633	906633



GOMA PASACASCOS

THRU HULL BELLOW

GOMMA PASSASCAFO

KIT SOUFFLET SAIL DRIVE

REF	OEM	
REC22303438	854932	110, 120, 120S, 130,
CEF501001	22303438	150 MS25



RETENES Y AROS TÓRICOS

SEALS & RUBBER O-RINGS

PARAOLI E FASCIE TONDE

JOINTS SPI ET JOINTS TORIQUES

RETENES PEQUEÑOS EJE DE HÉLICE

DRIVES SEALING LITTLE RING

PARAOLIO PICCOLO ASSE ELICA

JOINTS SPI PETIT ARBRE D'HÉLICE

REF	OEM	
REC853808	853808 853871	AQ 280DP, 290DP DP-A, A2, B1, C, D XDP DPS-A, B FWD



RETENES GRANDES EJE DE HÉLICE

DRIVES SEALING BIG RING

PARAOLIO GRANDE ASSE ELICA

JOINT SPI GRAND ARBRE D'HÉLICE

REF	OEM	
REC851407	851407	AQ 280DP, 290DP DP-A, A2, B1, C, D XDP



RETÉN EJE DE HÉLICE

DRIVES SEALING RING

PARAOLIO ASSE ELICA

JOINTS SPI, ARBRE D'HÉLICE

REF	OEM	
REC3593663	3593663	130S-A, S-B, R-A, SR-B 150S-A, S-B, SR-A, SR-B 120S-E, S-D MSZ25S-A, SR-A



REF	OEM	
REC3863083	3863083	EXT   OUT DPH
REC3863080	3863080+3863081	INT   IN

REF	OEM	
REC897426	897426	AQ200, 250, 270, 270T, 275, 275A, 280T, 280L, 285A, 290A SP-A, A/MT, A1, A2, C



REC3863080		REC3863083	
------------	--	------------	---

REF	OEM	
REC3863090	3863090 3858303	SX



REF	OEM	
REC853868	853868	SP DP



RETÉN EJE TIPO JACKS

DRIVES SEALING RING TYPE JACKS

PARAOLIO ASSE ELICA TIPO JACKS

JOINTS SPI ARBRE D'HÉLICE TYPE JACKS

REF	OEM	
REC858464	858464	AD31D-A, L-A, P-A AD41B, D, L-A, P-A, AQAD41A D41D, L-A TAMD31, A, B TAMD41A, B, D TMD41D KAD32P, 42B, 43P-A, 44P D4-180I-B, I-C, I-D, I-E, I-F D4-210A-A, I-A, I-B, A-B D4-225I-B, A-C, A-D, I-C, I-D, A-E, I-E D4-260A-A, A-B, A-C, A-D, D-B, D-C, D-D, I-A, I-B, I-C, I-D, A-E, D-E, I-E D4-300A-A, A-C, A-D, D-A, D-C, I-A, I-C, I-D, A-E, D-E, D-D, I-E D6-280A-A, A-B, A-C, A-D, A-E, I-A, I-B, I-C, I-D, I-E D6-310I-A, A-A, A-B, A-C, A-D, D-B, D-C, D-D, I-B, I-C, I-D, A-E, D-E, I-E, D-A D6-330A-B, A-C, A-D, D-B, D-C, D-D, I-B, I-C, I-D, A-E, D-E, I-E D6-350A-A, A-B D6-370A-B, A-C, A-D, D-B, D-C, D-D, I-A, I-B, I-C, I-D, A-E, D-E, I-E, D-A D6-400A-E D6-435D-A, D-D, D-C, D-E, I-A, I-C, I-D, I-E





TRANSOM DP-S

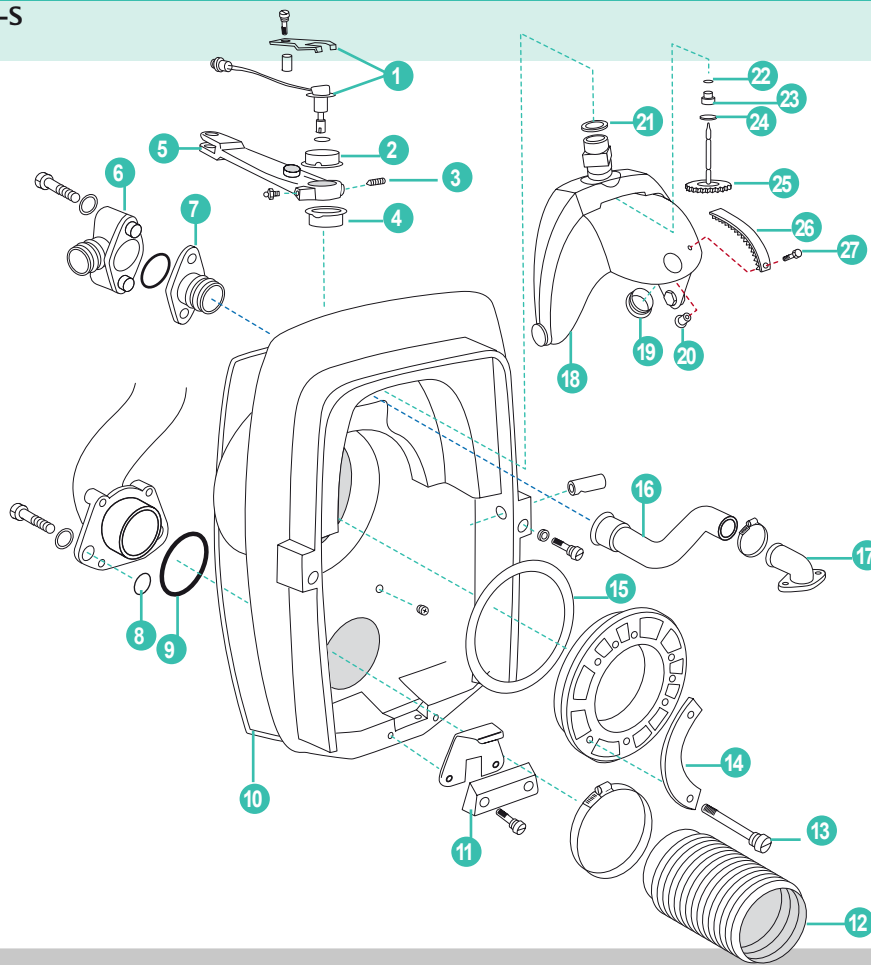

REF	OEM				
1	REC22314183 22314183	KIT SENSOR TRIM	TRIM SENSOR KIT	KIT SENSORE TRIM	KIT SONDE DE TRIM
2	RM854705 854705	CASQUILLO	BUSHING	BOCCOLA	BAGUE
3	REC947904 947904	TORNILLO TOPE	LOCK SCREW FOR STEERING FORK	VITE TRANSOM	BOULON PLATINE
4	RM854704 854704	CASQUILLO	BUSHING	BOCCOLA	BAGUE
5	REC872722 872722	BRAZO DIRECCIÓN	STEERING ARM	BRACCETTO DIREZIONE	BRAS DE DIRECTION
6	REC872338 872338	CONEXIÓN MANGUERA	HOSE NIPPLE	CONNESSIONE TUBO	RACCORD POUR DURITE
7	REC872334 872334	TOMA DE AGUA	NIPLE	TUBO ACQUAL	RACORD
8	REC925064 925064	ARO TÓRICO	O-RING	O-RING	JOINT TORIQUE
9	REC925256 925256	ARO TÓRICO	O-RING	O-RING	JOINT TORIQUE
10	REC852868 852868	GOMA TRANSOM	TRANSOM SEAL	GOMMA	JOINT DE PLATINE
11	REC852835 852835	ÁNODO ZN	ZN ANODE	ANODO ZN	ANODE ZN
12	REC876631 876631	FUELLE	BELLOW	CUFFIA	SOUFFLET D'ÉCHAPPEMENT
	RM876631 876631	FUELLE	BELLOW	CUFFIA	SOUFFLET D'ÉCHAPPEMENT
	CEF500505K 876631	FUELLE	BELLOW	CUFFIA	SOUFFLET D'ÉCHAPPEMENT
13	REC191844 191844	TORNILLO	SCREW	VITE	VIS
14	REC806624 806624	PLACA DE BLOQUEO	STRIKER PLATE	PIASTRA	PLAQUE DE BLOCAGE
15	REC813967 813967	ARO GOMA (Amarilla. Diesel)	RUBBER RING (Yellow. Diesel)	O-RING GOMMA (Giallo. Diesel)	JOINT TORIQUE (Jaune. Diesel)
	REC804190 813967	ARO GOMA (Verde. Gasolina)	RUBBER RING (Green. Fuel)	O-RING GOMMA (Verde. Benzina)	JOINT TORIQUE (Vert. Essence)
16	RM876632 876632	MANGUITO DE AGUA	WATER HOSE	MANICOTTO ACQUA	DURITE
17	REC872752 872752	PIPETA TOMA DE AGUA	HOSE CONNECTOR PLASTIC	PIPETTA PRESA D'ACQUA	RACCORD
18	REC872845 872845	HORQUILLA DE MANDO	STEERING YOKE	FORCELLA COMANDO	FOURCHE ET CASQUE
19	REC853048 853048	CASQUILLO	BUSHING	BOCCOLA	BAGUE
20	REC853760 853760	CASQUILLO TORNILLO CREMALLERA	RIVET NUT	GHIERA VITE CERNIERA	DOUILLE DE BOULON DE CRÉMAILLÈRE
21	RM977313 977313	RETÉN	SEAL RING	O-RING TENUTA	BAGUE D'ÉTANCHEITE
22	REC925050 925050	ARO TÓRICO	O-RING	O-RING	JOINT TORIQUE
23	REC851430 851430	CASQUILLO	BUSHING	BOCCOLA	BAGUE
24	REC966207 966207	RETÉN	SEAL RING	O-RING TENUTA	BAGUE D'ÉTANCHEITE
25	RM852984-4 852984	PIÑÓN	PINION	PIGNONE	PIGNON
26	REC872812 872812	SEGMENTO DENTADO	GEAR SEGMENT	CERNIERA TRIM	REGLETTE DE TRIM
27	REC853759 853759	TORNILLO	SCREW	VITE	VIS

TRANSOM SX



REF  
RM3858631



REF  
REC39631

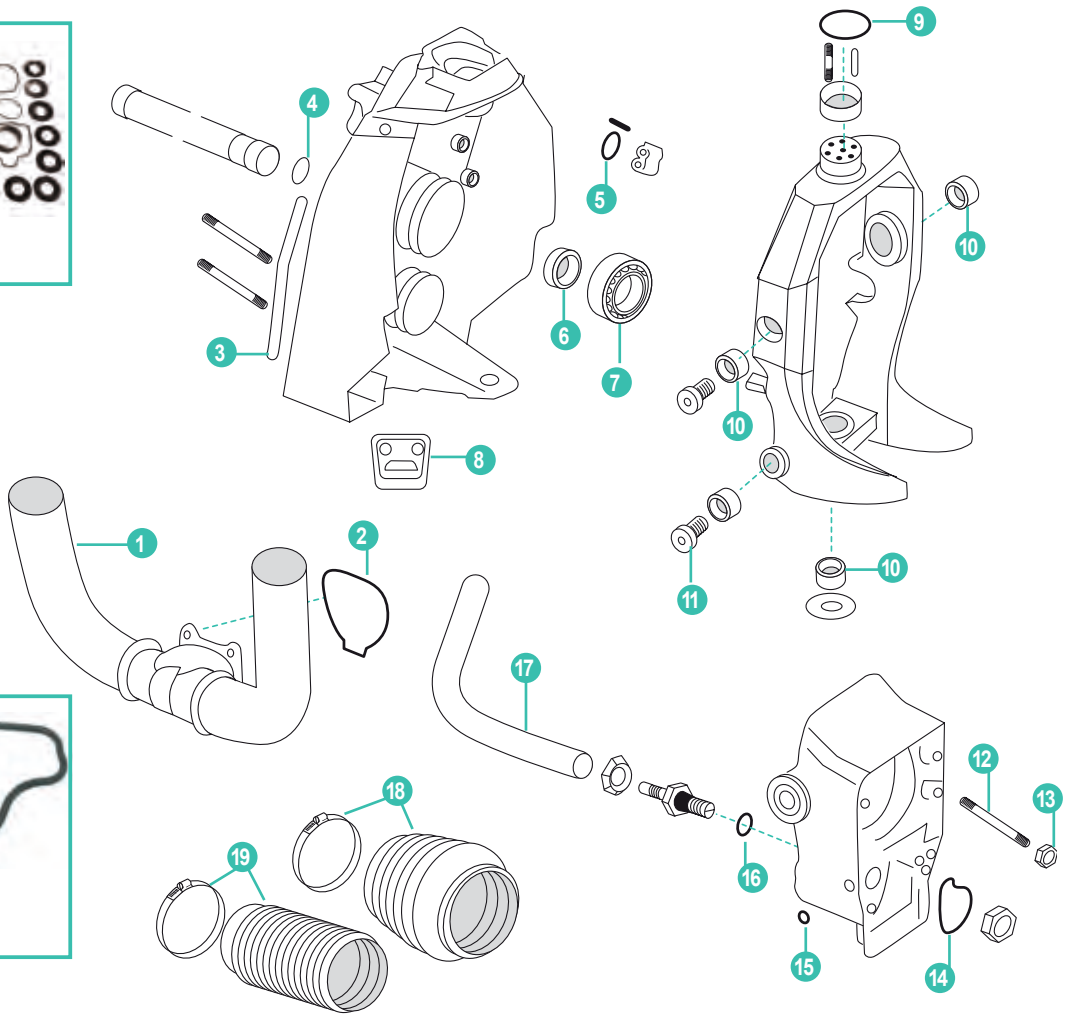

	REF	OEM			
1	RM3858873	3858873	CUERNOS ESCAPE COLA (4.3, 5.0, 5.7, 8.1)	EXHAUST MANIFOLD ASSEMBLY (4.3, 5.0, 5.7, 8.1)	CORNA DI SCARICO (4.3, 5.0, 5.7, 8.1) CORNE D'ÉCHAPPEMENT (4.3, 5.0, 5.7, 8.1)
2	RM3587651	3587651	JUNTA CUERNO ESCAPE	SEALING KIT	GUARNIZIONE CORNA DI SCARICO JOINT CORNE D'ÉCHAPPEMENT
3	REC3852550	3852550	JUNTA TRANSOM	SEALING TRANSOM	GUARNIZIONE TRANSOM JOINT TRANSOM
4	REC309731	3852537	ARO TÓRICO	O-RING	FASCIA TONDA JOINT TORIQUE
5	REC331188	3852169	ARO TÓRICO	O-RING	FASCIA TONDA JOINT TORIQUE
6	REC3852548 RM3883257	3852548 3883257	RETEN TRASERO SX RETEN TRASERO SX-A	SEALING, DRIVE SHAFT SX SEALING, DRIVE SHAFT SX-A	PARAOLIO POSTERIORE SX PARAOLIO POSTERIORE SX-A JOINT SPI ARRIÈRE SX JOINT SPI ARRIÈRE SX-A
7	REC30-879194A01 REC3888555	21752712 3888555	COJINETE SX COJINETE SX-A	BEARING TRANSOM SX BEARING TRANSOM SX-A	CUSCINETTO SX CUSCINETTO SX-A ROULEMENT SX ROULEMENT SX-A
8	REC3854130 REC3586461AL	3854130 3854130	ÁNODO ZN ÁNODO AL	ANODE ZN ANODE AL	ANODO ZN ANODO AL
9	REC25-33145	3852044	ARO TÓRICO	O-RING	FASCIA TONDA JOINT TORIQUE
10	REC3808228	3808228	CASQUILLO	PIVOT PIN BEARING	BOCCOLA BAGUE
11	REC3853423	3853423	CASQUILLO	BUSHING	BOCCOLA BAGUE
12	REC3852551	3852551	ESPÁRRAGO	STUD	PERNO GOUJON
13	REC11-859135	3852648	TUERCA	NUT	DADO ÉCROU
14	REC3852560	3852560	RETEN GOMA	SEALING, WATER PASSAGE	TENUTA GOMMA JOINT CAOUTCHOUC
15	REC332583	3852523	ARO TÓRICO	O-RING	FASCIA TONDA JOINT TORIQUE
16	REC3852535	3852535	ARO TÓRICO	O-RING	FASCIA TONDA JOINT TORIQUE
17	REC3852352	3852352	TUBO SUBIDA AGUA	WATER INLET HOSE	TUBO USCITA ACQUA DURITE ENTRÉE D'EAU
18	REC3841481 CEF500514K	3841481	FUELLE COLA con abrazadera	BELLOW KIT	CUFFIA CARDANO con fascetta SOUFFLET AVEC BAGUE
19	REC3850426 CEF500528	3850426	MANGUITO ESCAPE	EXHAUST HOSE	MANICOTTO SCARICO SOUFFLET D'ÉCHAPPEMENT
20	RM3858631	3858631	KIT RETENES	SEAL KIT	KIT PARAOLIO KIT JOINTS COMPLET
21	REC39631		KIT AROS	O-RINGS KIT	KIT FASCIE TONDE KIT JOINT

# TRANSOM SX-A TSK

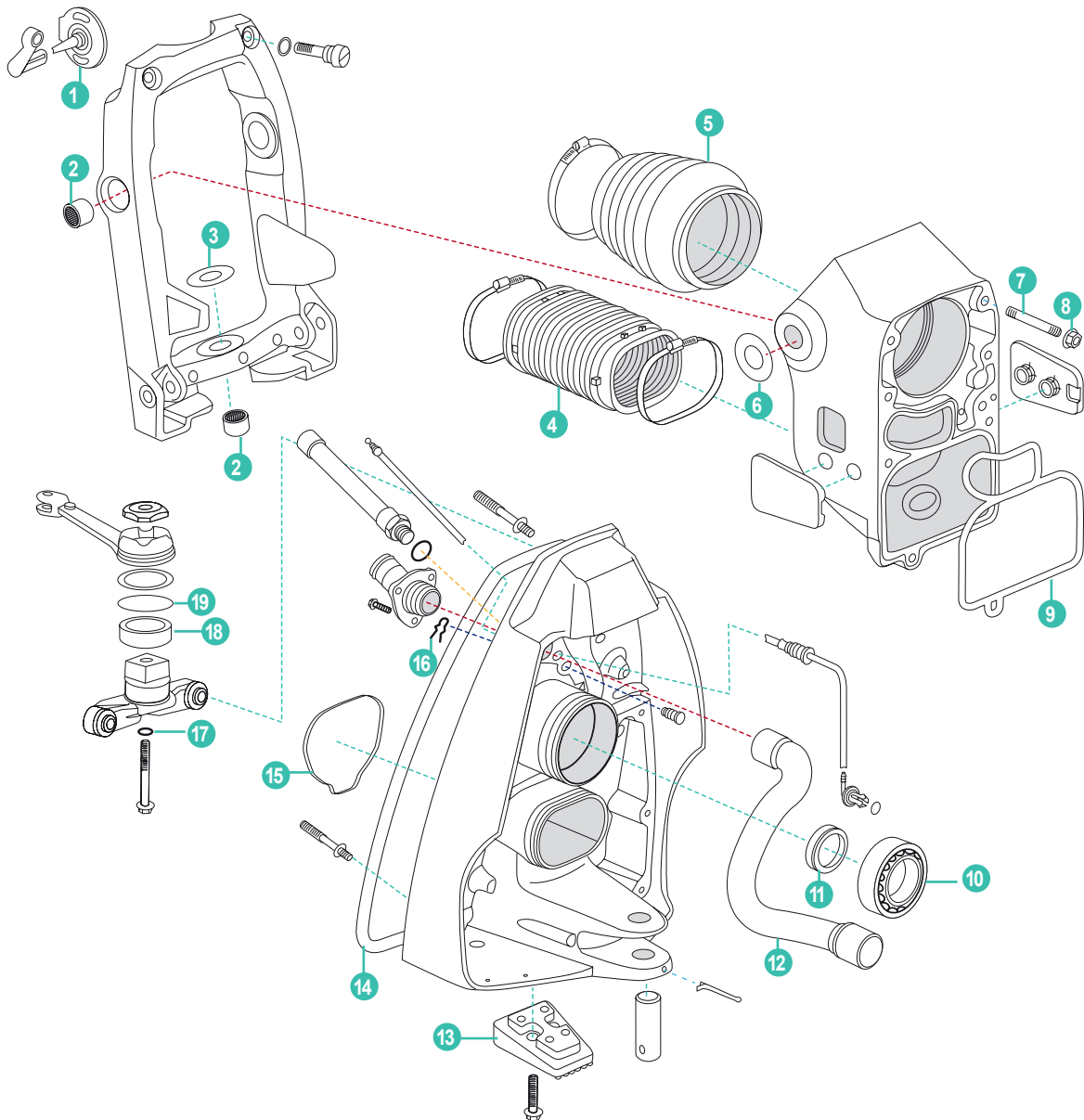

	REF	OEM				
1	REC21484383	21484383	SENSOR TRIM	TRIM SENDER	SENSORE TRIM	SONDE DE TRIM
2	REC3808228	3808228	CASQUILLO	BUSHING	BOCCOLA	BAGUE
3	REC3852558	3852558	ARANDELA	WASHER	RONDELLA	RONDELLE
4	REC3888916	3888916	FUELLES ESCAPE	EXHAUST BELLOW	CUFFIA SCARICO	SOUFFLET D'ÉCHAPPEMENT
5	RM22197130	22197130	KIT FUELLE	BELLOW KIT	KIT CUFFIA	KIT SOUFFLET DE CARDAN
6	REC3852558	3852558	ARANDELA	WASHER	RONDELLA	RONDELLE
7	REC3852551	3852551	ESPÁRRAGO	STUD	PERNO	GOUJON
8	REC11-859135	3852648	TUERCA	NUT	DADO	ÉCROU
9	REC3889788	3889788	JUNTA	GASKET	GUARNIZIONE	JOINT SPI
10	REC3888555	3888555	COJINETE	BEARING	CUSCINETTO	ROULEMENT
11	RM3883257	3883257	RETÉN	SEAL	TENUTA	JOITN SPI
12	REC3883777	3883777	MANGUERA	TUBO	TUBO	DURITE
13	REC3888817	3888817	ÁNODO DE ZN	ZN ANODE	ANODO ZN	ANODE ZN
	REC23164611AL	3888816	ÁNODO DE AL	AL ANODE	ANODO AL	ANODE AL
14	REC3841011	3841011	JUNTA	GASKET	GUARNIZIONE	JOINT DE PLATINE
15	REC3841013	3841013	JUNTA	GASKET	GUARNIZIONE	JOINTI
16	REC3852555	3852555	SOPORTE	SUPPORT	SUPPORTO	SUPPORT
17	REC3852045	3852045	ARO TÓRICO	O-RING	O-RING	JOINT TORIQUE
18	REC3840761	3840761	CASQUILLO	BUSHING	BOCCOLA	BAGUE
19	REC946056	946056	ARO TÓRICO	O-RING	O-RING	JOINT TORIQUE

**COMPONENTES  
TRANSOM**

**TRANSOM  
COMPONENTS**

**COMPONENTI  
TRANSOM**



**COMPOSANTS  
TRANSOM**



**GUIA KITS RODAMIENTOS  
Y RETENES TRANSOM**

**FLYWHEEL CASING  
REPAIR KITS GUIDE**

**GUIDA KIT CUSCINETTI E  
PARAOILI TRANSOM**

**GUIDE KITS ROULEMENTS  
ET JOINTS SPI**

		REF
B 16	80	REC22057
AQD 19	100	REC22057
AQD 21A	250	REC22059
AQD 21A,B	270, 280	REC22074
AQD 27	200	REC22059
AQD 29	200, 250	REC22059
AD 30A	290A, DP	REC22075
AQAD 30A	280DP, PT, 290A, DP	REC22075
AQAD 30A	Cardan drift / Cardan shaft	2 x REC22075
AD 31A,B	290A, DP, SP-C, DP-C, DP-D	REC22075
AQAD 31A	290A, DP	REC22075
TAMD 31 B	SP-A2, DP-A2	REC22075
AQD 32A	250	REC22059
AQD 32A	270, 280	REC22074
AQD 40A	280, DP, PT	REC22075
AQAD 40A,B	280, DP, PT, 290, DP	REC22075
AQAD 40B	Cardan drift / Cardan shaft	2 x REC22075
AD 40B	280, DP, 290, DP	REC22075
AD 41A	290, DP	REC22075
AD 41B	SP-A2-C, DP-C-D-B1	REC22075
AQAD 41 A	290A, DP	REC22075
AQD 41A	290A, DP	REC22075
D 41 B	SP-A2, DP-A2	REC22075
TAMD 41B	SP-A2, SP-C, DP-B1, DP-D	REC22075
KAD 42	SP-D	REC22075
AD31D	DP-D1, SP-C1	REC22161
AD31L-A	DO-D1, SX	REC22161
AD31P-A	DP-D1, SX	REC22161
AD31XD	DP-D1	REC22161
AD41D	DP-D1, SC-C1	REC22161
AD41L-A	DP-D1	REC22161
AD41P-A	DP-D1	REC22161
D14D	DO-D1, SP-C1	REC22161
D41L-A	DP-D1	REC22161
KAD32P-A	DP-E, DP-G, DPX	REC22161
KAD42B	DP-D1, DPX	REC22161
KAD42P-A	DP-D1, DPX	REC22161
KAD43P-A	DP-D, DP-E, DP-G, DPX	REC22161
KAD44P-A	DP-D, DP-E, DP-G, DPX	REC22161
KAD44P-B	DP-D	REC22161
KAD44P-C	DP-E, DP-G, DPX	REC22161
KAD300A	DP-G, DP-E, DPX	REC22161
KAMD42P-A	DP-D1, DPX	REC22161
KAMD44P-C	DP-E	REC22161
KAMD300A	DP-G, DP-E, DPX	REC22161
AD31XD	SP-C1	REC22163
TAMD31D	DP-D1, SP-C1	REC22163

		REF
AQ 171 A,C	290A, SP-A	REC22074
AQ 175, 200B, C, D	280, PT, 290	REC22075
AQ 205A	SP-A, DP-A	REC22075
AQ 211A	290A,DP, SP-A, DP-A	REC22075
AQ 225A, B, C, D, E, F	275, 280, PT, 280L, 290, A, DP	REC22075
230	275, SP-A, SP-A1	REC22074
AQ 231A,B	275, 285, 290A,DP	REC22075
250, 251	SP-A, SP-A1	REC22074
AQ 255A,B	280	REC22075
AQ 260A	280, PT, 290	REC22075
AQ 271A,B,C,D	275, 290A	REC22075
AQ 290A	280PT, 290	REC22075
AQ 311 A,B	290A, SP-A	REC22075
430	SP-A, DP-A	REC22075
430A	SP-A1, SP-A2, SP-C, DP-A, DP-A1, DP-A2, DP-C	REC22075
430B	SP-C, DP-C	REC22075
431A	SP-A, SP-A1, SP-A2, SP-C, DP-A, DP-A1, DP-A2, DP-C	REC22075
431B	SP-C, DP-C	REC22075
432A	SP-C1, DP-C1	REC22055
434A	SP-C1, DP-C1	REC22055
500B	SP-A1, SP-A2, SP-C, DP-A1, DP-A2, DP-C	REC22075
500B	SP-C1, DP-C1, DP-D1	REC22055
501B	SP-A2, SP-C, DP-A2, DP-C	REC22075
501B	SP-C1, DP-C1, DP-D1	REC22055
570A	SP-A, SP-A1, SP-A2, SP-C, DP-A, DP-A1, DP-A2	REC22075
570A	SP-C1, DP-C1, DP-D1	REC22055
572A	SP-C, DP-C	REC22075
572A	SP-C1, DP-C1, DP-D1	REC22055
740A	DP-B, DP-B1, DP-C	REC22075
740B	DP-C, DP-C	REC22075
740B	SP-C1, DP-C1, DP-D1	REC22055
AQ 115A,B,C	250	REC22059
AQ 120A	200	REC22059
AQ 120B	270	REC22074
AQ 125A,B	270, 275A	REC22074
AQ 130	100	REC22057
AQ 130	250	REC22059
AQ 130	270, 270T, 280	REC22074
AQ 131A,B,C,D	275, 290, SP-A	REC22074
AQ 140A	280, 280PT	REC22074
AQ 145A,B	280, 280PT, 290	REC22074
AQ 151A,B,C	290, 290A, SP-A	REC22074
AQ 165A	250	REC22060
AQ 165A	250	REC22074
AQ 170	250, 270, 270T, 280, 280T	REC22074
AQ 170	270	REC22060



REC22057



REC22161



REC22074



REC22060



REC22059



REC22163



REC22055



REC22075



**RODAMIENTOS EJE**      **SHAFT BEARING**      **CUSCINETTO ASSE**      **ROULEMENT D'ARBRE**

REF	OEM	
REC911013	11013 7011013	30 x 62 mm

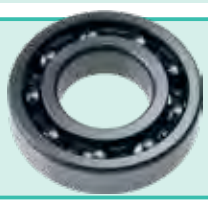

new

**RETÉN EJE CAMPANA**      **SHAFT BELL SEAL**      **PARAOLIO ASSE CAMPANA**      **JOINT SPI ARBRE DE CASQUE**

REF	OEM	
REC958860	958860 941870	V6&tV8, Aq inline D30,31,41,40,21,42,43,44,300,13,3,4,6 62 x 35 mm



new

**CIRCLIP PARA EJE**      **SHAFT CLIP**      **CLIP ASSE**      **CLIP ARBRE**

REF	OEM	
REC914462	914462	30 x 1.5 mm
REC914533	914533	62 X 2 mm



new

**RETÉN TRANSOM**      **SEAL OIL**      **TENUTE**      **JOINT SPI**

REF	OEM	
REC946242	946242	55 x 35 mm V6 Et V8 AQ inline



new

**GOMAS TRANSOM**      **SEALING STRIPS**      **GOMMA**      **JOINT DE TRANSOM**

REF	OEM	
REC897726	897726	AQ 200, 250, 270, 270T, 275, 275A AQ280, T, D, P, SP-A/MT



REF	OEM	
REC852868	852868	AQ290, A, DP SP-A, A1, A2, C, C1 DP-A1, A2, B, B1, C, C1, D, D1, X



**GOMA CIERRE IPS**      **IPS RUBBER LOCK**      **GOMMA CHIUSURA IPS**      **JOINT TORIQUE IPS**















REF	OEM
REC22256171	22256171 3861068



**GOMAS CAMPANA**      **RUBBER RING**      **GOMMA CAMPANA**      **ANNEAU DE CLOCHE**

REF	OEM	
REC813967	813967	■
REC804190	804190	■



FUELLES		BELLOW		CUFIE		SOUFFLET	
FUELLE ESCAPE EXHAUST BELLOW CUFFIE SCARICO SOUFFLET ECHAPPEMENT		FUELLE TRANSMISIÓN DRIVE BELLOW CUFFIE CARDANO SOUFFLET CARDAN					
REC876631	876631	REC876294	876294	AQ 200, 250, 270, 275, 280, 280DP, 290, 290DP			
CEF500505K	875848	CEF500510K	875826	SP-A, A/MT, A1, A2, C			
RM876631		RM876294	897889	DP-A, A1, A2, B, C, D, X			
				Con protección metálica. Sin válvula. With metallic protection, w/o valve. Con protezione metallica. Senza valvola. Avec protection métallique. Sans vanne.			
FUELLE ESCAPE EXHAUST BELLOW CUFFIE SCARICO SOUFFLET ECHAPPEMENT		FUELLE TRANSMISIÓN DRIVE BELLOW CUFFIE CARDANO SOUFFLET CARDAN					
REC876633		REC876294	876294	AQ 280, 280T, 280PT, 280DP			
CEF500505FL	876633	CEF500510K	875826	SP-A			
RM876633		RM876294	897889	DP-A, A1, A2, B, C, D, X			
				Con protección metálica. Con válvula. With metallic protection, with valve. Con protezione metallica. Con valvola. Avec protection métallique. Avec vanne.			
FUELLE ESCAPE EXHAUST BELLOW CUFFIE SCARICO SOUFFLET ECHAPPEMENT		FUELLE TRANSMISIÓN DRIVE BELLOW CUFFIE CARDANO SOUFFLET CARDAN					
REC3850426	3850426	REC3841481	3841481	SX-S, C1, C2, R, R1, R2, M, M1			
CEF500528		CEF500514K	3854127	DP-SM			
							
FUELLE ESCAPE EXHAUST BELLOW CUFFIE SCARICO SOUFFLET ECHAPPEMENT		FUELLE TRANSMISIÓN DRIVE BELLOW CUFFIE CARDANO SOUFFLET CARDAN					
REC3888916	3888916	RM22197130	22197130	SX-A			
CEF500536K				DPS-A, B			
				Nuevo diseño de goma rígida New design rigid rubber Nuovo design in gomma rigida Nouveau design en caoutchouc rigide			
FUELLE ESCAPE EXHAUST BELLOW CUFFIE SCARICO SOUFFLET ECHAPPEMENT		FUELLE TRANSMISIÓN DRIVE BELLOW CUFFIE CARDANO SOUFFLET CARDAN					
CEF500538K	3588753 3808536 3862168	REC3808898	3808898	DPH-A, B, C, D			
		CEF500537K	3594509	DPR-A, B, C, D			
							

FUELLE ESCAPE EXHAUST BELLOW CUFFIE SCARICO SOUFFLET ECHAPPEMENT		FUELLE TRANSMISIÓN DRIVE BELLOW CUFFIE CARDANO SOUFFLET CARDAN		
REF	OEM	REF	OEM	
RM3885870	3885870	RM21277185	21277185 3886847 3841482	X-B, BLT TSK



FUELLE ESCAPE EXHAUST BELLOW CUFFIE SCARICO SOUFFLET ECHAPPEMENT		FUELLE TRANSMISIÓN DRIVE BELLOW CUFFIE CARDANO SOUFFLET CARDAN		
REF	OEM	REF	OEM	
REC3860384	3860384 3858139	REC876294 CEF500510K RM876294	876294 875826 897889	DP-G DPX-A



FUELLE TRANSMISIÓN	DRIVE BELLOW	CUFFIE CARDANO	SOUFFLET CARDAN						
<table border="1"> <thead> <tr> <th>REF</th> <th>OEM</th> <th></th> </tr> </thead> <tbody> <tr> <td>REC875512</td> <td>875512 875827 804186</td> <td>AQ80, 100, 100B, 100S</td> </tr> </tbody> </table>		REF	OEM		REC875512	875512 875827 804186	AQ80, 100, 100B, 100S		
REF	OEM								
REC875512	875512 875827 804186	AQ80, 100, 100B, 100S							

MANGUITOS COLA	DRIVE HOSE	MANICOTTO PIEDE	DURITE D'EMBASE												
<table border="1"> <thead> <tr> <th>REF</th> <th>OEM</th> <th></th> </tr> </thead> <tbody> <tr> <td>REC875822 CEF501011</td> <td>875822 22303438</td> <td>AQ 200, 250, 270, 275, 280, 280DP, 280PT, 285A SP-A/MT</td> </tr> </tbody> </table>		REF	OEM		REC875822 CEF501011	875822 22303438	AQ 200, 250, 270, 275, 280, 280DP, 280PT, 285A SP-A/MT	<table border="1"> <thead> <tr> <th>REF</th> <th>OEM</th> <th></th> </tr> </thead> <tbody> <tr> <td>RM876632</td> <td>876632 875747 854555</td> <td>AQ290, 290A, 290DP SP-A, A1, A2, C DP-A, A1, A2, B, B1, C, D, X</td> </tr> </tbody> </table>		REF	OEM		RM876632	876632 875747 854555	AQ290, 290A, 290DP SP-A, A1, A2, C DP-A, A1, A2, B, B1, C, D, X
REF	OEM														
REC875822 CEF501011	875822 22303438	AQ 200, 250, 270, 275, 280, 280DP, 280PT, 285A SP-A/MT													
REF	OEM														
RM876632	876632 875747 854555	AQ290, 290A, 290DP SP-A, A1, A2, C DP-A, A1, A2, B, B1, C, D, X													



<table border="1"> <thead> <tr> <th>REF</th> <th>OEM</th> <th></th> </tr> </thead> <tbody> <tr> <td>REC3852352</td> <td>3852352</td> <td>SX DP-S</td> </tr> </tbody> </table>		REF	OEM		REC3852352	3852352	SX DP-S	<table border="1"> <thead> <tr> <th>REF</th> <th>OEM</th> <th></th> </tr> </thead> <tbody> <tr> <td>REC832831</td> <td>832831</td> <td>AQ 270T, 280T</td> </tr> </tbody> </table>		REF	OEM		REC832831	832831	AQ 270T, 280T
REF	OEM														
REC3852352	3852352	SX DP-S													
REF	OEM														
REC832831	832831	AQ 270T, 280T													



CAMBIO

SHIFT

CAMBIO

CHANGEMENT

MECANISMO DE CAMBIO SHIFT MECHANISM

MECCANISMO DI CAMBIO MECANISME DE CHANGEMENT

REF	OEM	
REC21256410	21256410 3889982 3843471	DPS-A, DPS-B, DPS-C FWD, SX-A, SX-D

REF	OEM	
REC22273952	22273952 3762385	DPH-DPR

PISTÓN SELECTOR SHIFT PLUNGER

PISTONE SELETORE SÉLECTEUR DE VITESSE

REF	OEM	
REC3856008	3856008 3852325 0897816	AQUAMATIC Inversoras   Inverters   Inversore   Inverseurs



SOPORTE MOTOR

ENGINE MOUNT SCREW SUPPORTI MOTORE

SUPPORT MOTEUR

REF	MÁX
GS38103	55 kg 120 lbs
GS38104	160 kg 355 lbs

Fabricado en metal y neopreno vulcanizado.  
Manufactured in metal and vulcanized neoprene.  
Supporto elastico in metallo e neoprene  
Fabriqué en métal et en néoprène vulcanisé.

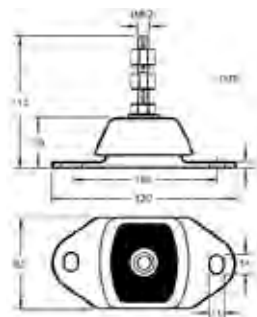

GS38103

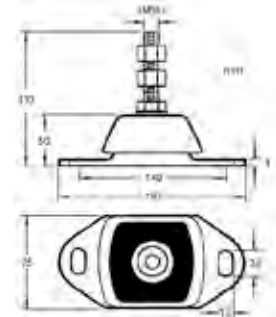

GS38104

REF	OEM	
REC803762	803762	BB30, 100, 115, 165, 170 MB10A, 18, 20 2001, 2002, 2003, 2010, 2020, 2030, 2040 D1, 2 MD1, 2, 3, 5, 6, 7, 11, 17, 21, 22, 29, 32 AQD2 D1-13A, B, F D1-20A, B, F D1-30A, B, F D2-40A, B, F D2-55A, B, C, D, E, F D2-75A, B, C, F



REF	OEM	
REC843323	843323	AQAD40A, B AQAD41A AQD40A AD41A, B, D, L-A, P-A D41A, B, D, L-A KAD42A, B, P-A



TORNILLO

SCREW

VITI

BOULON

REF	OEM	
REC861431	861431	D1-13A, B, F D1-20A, B, F D1-30A, B, F D2-40A, B, F MD2010A, B, C, D MD2020A, B, C, D MD2030A, B, C, D MD2040A, B, C, D AQAD40A, B AQAD41A AQD40A AD41A, B, D, L-A, P-A D41A, B, D, L-A KAD42A, B, P-A





## KIT PRENSAESTOPAS DE GOMA

## RUBBER SEAL KIT

## KIT PREMISTOPPA IN GOMMA

## KIT PRESSE ETOUPE

REF	Ø EJE Ø SHAFT Ø ASSE Ø ARBRE	A	B	C
RM828254	25 mm	36 mm	66 mm	42 mm
RM828422	30 mm	36 mm	72 mm	48 mm
RM828526	35 mm	36 mm	82 mm	54 mm
RM828527	40 mm	36 mm	82 mm	60 mm
RM3819722	45 mm	36 mm	95 mm	64 mm
RM3819723	50 mm	36 mm	95 mm	68 mm
RM3819724	1"	36 mm	66 mm	1-5/8"
RM3819725	1 1/4"	36 mm	76 mm	2"
RM3819726	1 1/2"	36 mm	85 mm	2-1/4"
RM3819727	1 3/4"	36 mm	95 mm	2-1/2"
RM3819728	2"	36 mm	95 mm	2-1/2"

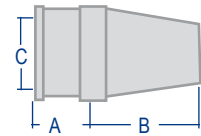

## DAMPER

## VIBRATION DAMPER

## DAMPER

## DAMPER

REF	OEM	AGUJERO HOLE FUORI TROU
REC855694	430B	14"
	431B	
	432A	
	434A	
	570A	
	572A	
	855694	
	835550	
	855648	
	500B	
	501B-MS4	
	570A-MS4	
	BB225A, B, C	
	BB260A, B, C	
231A		
261A		
4.3L HU, LK, GL, NC		
5.7L Gi-HU, LK, MD, NC		



REF	OEM	AGUJERO HOLE FUORI TROU
REC855617	AD41A, B, D	Ø 34 mm 26
	AQAD41A	
	D41A, B, D	
	KAD42A, B, D, P	
	KAD43P	
	KAD44PEDC	
	KAMD42A, B	
	TAMD41A, B	
	TMD41A, B	
	KAD300A	



REF	OEM	AGUJERO HOLE FUORI TROU
REC841893	841893	B30
	824991	D21
	831106	D40



REF	OEM	AGUJERO HOLE FUORI TROU
REC855389	230A, B	Ø 34 mm 26
	250A, B	
	251A	
	AD31A, B, D, XD	
	AQ115A, B	
	AQ120B	
	AQ125A, B	
	AQ130A, B, C, D	
	AQ140A	
	AQ145A, B	
	AQ151A, B, C	
	AQ171A, C	
	AQAD31A, 40B	
	AQD40A	
	BB115A, B, C	
	BB140A	
	BB145A	
	KAD32P	
MB20A, B, C		
MB30A, 31A, 40A		
TAMD30A, B		
TAMD31A, B, D		
TAMD40A, B		
TMD30A		
TMD31A, B, D		
TMD40A, B, C		



## ACOPLAMIENTOS MOTOR

## ENGINE COUPLER ASSEMBLIES

## ACCOPIAMENTO MOTORE

## ACCOUPLLEMENT MOTEUR

REF	OEM	AGUJERO HOLE FUORI TROU	CUBO SALIDA HUB OUTER CUBO USCITA SORTIE DU CUBE
REC3853962	2.5L (1986)	Ø 91 mm	Ø 43 mm
	3.0L (1986-90)		
	4.3L		
	5.0L		
	5.7L (1986) KX & KWB		
	7.4L (1990-98)		
	8.2L (1992-93, 1998)		
REC3858437	DPX375, 385, 415	Ø 76 mm	Ø 43 mm
	4.3L (1986-98)		
	5.0L (1986-88, 1998)		
REC3853862	5.7 (1986-92, 1994, 1996-98)	Ø 76 mm	Ø 35 mm
	5.0 & 5.8L (1989-96)		



REC3853962



REC3858437



REC3853862

# SISTEMA DE PROPULSIÓN PROPULSION SYSTEM

# SISTEMA DI PROPULSIONE SYSTEME DE PROPULSION

HÉLICES ALUMINIO E  
INOXIDABLE  
DE 3 Y 4 PALAS

3 & 4 BLADE  
ALUMINIUM & SS  
PROPELLERS

ELICHE ALLUMINIO E  
INOX DA 3 E 4 PALE

HELICE ALUMINIUM ET  
INOX 3 ET 4 PALES

CÓDIGO DE REFERENCIAS

PART NO. CODING SYSTEM

SISTEMA DI CODICE

CODAGE DES REFERENCES

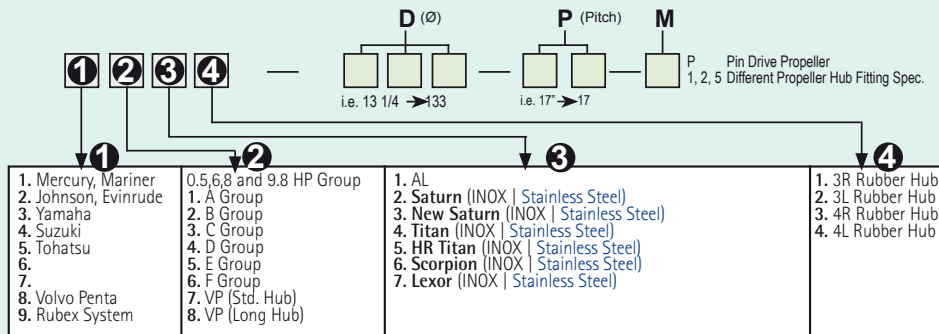

SOLAS

## AMITA 3

SOLAS

Hélice de aluminio con núcleo de goma de gran resistencia.

Aluminum propeller with heavy duty rubber hub.

Eliche di alluminio con mozzi in gomma ad alta resistenza.

Hélice en aluminium avec moyeu en caoutchouc



## AMITA 3 PLUS

SOLAS

Diseño de pala grande para un área más grande.

High camber blade and large blade area design.

Con un'area più ampia nelle pale.

Conception d'une grande pale pour une plus grande surface de poussée.



## TITAN

SOLAS

- Hélices de acero inox de 3 palas.
- Diseño de pala grande para un área más grande.
- Gran capacidad de transporte de carga.
- Excelente economía de combustible.
- 3 blade stainless steel propeller.
- High camber blade and large blade area design.
- Great load carrying capability.
- Excellent fuel economy.
- Eliche a 3 pale in acciaio inossidabile.
- Con un'area più ampia nelle pale.
- Ampia capacità di carico.
- Eccellente economia di carburante.
- Hélices à 3 pales en acier inoxydable.
- Conception d'une grande pale pour une plus grande surface de poussée.
- Capacité de charge élevée.
- Excellente économie de carburant.



## NEW SATURN

SOLAS

Hélices de acero inoxidable. Ofrece buena aceleración y rendimiento. Tamaño más pequeño que ofrece un diámetro extragrande.

Stainless steel propeller. Offers good acceleration & all-round performance. Smaller pitch sizes offered in extra large diameter with increased blade area.

Eliche di acciaio inox. Buona accelerazione. Piccole dimensioni che offre un più grande diametro.

Hélice inox, offrant de bonnes accélérations et performances. Taille de pas réduite pour les modèles de grands diamètres avec une surface de pale plus importante.



## HR TITAN 3 PROP

SOLAS

Hélice de acero inoxidable. Alto rendimiento para cascos de alta velocidad. La inclinación de la hoja proporciona un excelente elevación de proa y aceleración. El diseño de copa grande aumenta la mordida y reduce el deslizamiento.

Stainless steel propeller. Performance prop for high speed planning hulls. High rake blade design provides excellent bow lift and acceleration. Heavy cup design increases bite and reduces slip.

Eliche in acciaio inox. Alte prestazioni per scafi ad alta velocità. Il passo della pala fornisce un'eccellente spinta e accelerazione. Il disegno aumenta le prestazioni.

Hélice en acier inoxydable. Hélice de performance pour les coques planantes à grande vitesse. La conception de la pale à haut râteau offre une excellente portance et accélération. La conception des grandes pales augmente l'attaque et réduit le glissement.



**GUÍA DE HÉLICES  
CON NÚCLEO INTEGRADO**

**PROPELLERS APPLICATION  
WITH RUBBER HUB**

**GUIDA ELICHE  
CON MOZZO**

**GUIDE DES HELICES AVEC  
MOYEU**

TIPO	AL	INOX STAINLESS STEEL					
		AMITA 3	AMITA 3 PLUS	NEW SATURN TITAN HR TITAN 3			
<b>AQUAMATIC</b>							
AQ270	854996	15	15	R	SOL8831-150-15		
AQ275	854981	15	15	L	SOL8832-150-15		
AQ280	854997	15	17	R	SOL8831-150-17		
AQ290	854982	15	17	L	SOL8832-150-17		
Cubo largo	854998	17	3	R	AL SOL8831-150-19		
Long Hub	854983	15	19	L	SOL8832-150-19		
Mozzo lungo	854999	15	21	R	SOL8831-150-21		
11,5 mm	854984	15	21	L	SOL8832-150-21		
AQ200D/290	872001	15	15	R	SOL8811-150-15 SOL8811-158-15	SOL8841-156-15	
AQ225D/290	854987	15	15	L	SOL8812-150-15 SOL8812-158-15	SOL8842-156-15	
AQ260D/290	872002	14.8	17	R	SOL8811-148-17 SOL8811-155-17	SOL8841-156-17	
AQ290A/290	854988	14.8	17	L	SOL8812-148-17 SOL8812-155-17	SOL8842-156-17	
AQAD40B/290	872003	14.5	19	R	SOL8811-145-19 SOL8811-153-19	SOL8841-156-19	
AQAD41/290	854989	3	14.5	L	AL SOL8812-145-19 SOL8812-153-19	SOL8842-156-19	
Cubo largo	872004	17	14.3	21	R	SOL8811-143-21 SOL8811-153-21	SOL8841-156-21
Long Hub	854990	17	14.3	21	L	SOL8812-143-21 SOL8812-153-21	SOL8842-156-21
Mozzo lungo			14.2	23	R	SOL8811-142-23	SOL8841-156-23
			14.2	23	L	SOL8812-142-23	SOL8842-156-23
Cubo estandar			15.5	15	L	SOL8712-150-15	
Standard Hub			14.8	17	L	AL SOL8712-148-17	
Mozzo standard			14.5	19	L	SOL8712-145-19	
9,5 mm			14.3	21	L	SOL8712-143-21	
SX							
	3817466	15	15	R	SOL8611-150-15 SOL8613-148-15	SOL8641-155-15	
	3817471	15	15	L	SOL8612-150-15 SOL8614-148-15	SOL8642-155-15	
	3817467	14.8	17	R	SOL8611-148-17 SOL8613-145-17	SOL8651-148-17	
3.0 L	3817472	14.8	17	L	SOL8612-148-17 SOL8614-145-17	SOL8652-148-17	
4.3 L	3817468	14.5	19	R	AL SOL8611-145-19 SOL8613-143-19	SOL8651-148-19	
5.0 L	3817473	19	3	L	SOL8612-145-19 SOL8614-143-19	SOL8652-148-19	
5.7 L	3817469	14.3	21	R	SOL8611-143-21 SOL8613-140-21	SOL8651-145-21	
5.8 L			14.3	21	L	SOL8612-143-21 SOL8614-140-21	SOL8652-145-21
7.4 L			14.2	23	L	SOL8611-142-23	SOL8642-145-23
	3817470		15	5/8	15 R	Inox SOL8651-140-24	
	3850305		15	5/8	15 L	SS SOL8652-140-24	
	3850315		15	5/8	15 L	SS SOL8652-140-24	

**HÉLICES ALUMINIO  
E INOX CON NÚCLEO  
INTERCAMBIABLE**

Altas prestaciones. Núcleo de goma intercambiable con sistemas Flo-Torq Et Vortex System. Disponible en acero inox y aluminio

**ALUMINIUM & SS  
PROPELLERS WITH  
INTERCHANGEABLE HUB**

High performance / Rubber Hub interchangeable with Flo-Torq Et Vortex System. Available in stainless Steel Et Aluminium Propeller

**ELICHE ALLUMINIO  
E INOX CON MOZZO  
INTERCAMBIABILE**

Alte prestazioni. Mozzo in gomma intercambiabile con sistema Flo-Torq Et Vortex System. Disponibile in acciaio inox e alluminio.

**HÉLICES ALUMINIUM  
ET INOX AVEC MOYEU  
INTERCHANGEABLE**

Haute performance. Moyeu en caoutchouc interchangeable avec le système Flo-Torq et Vortex System. Disponible en inox et en aluminium.

AL	D	P	R
3 PALAS   BLADES   PALE   PALES			
SOL9511-150-15	15	15	R
SOL9512-150-15	15	15	L
SOL9511-148-17	14.8	17	R
SOL9512-148-17	14.8	17	L
SOL9511-145-19	14.5	19	R
SOL9512-145-19	14.5	19	L
SOL9511-143-21	14.3	21	R
SOL9512-143-21	14.3	21	L
4 PALAS   BLADES   PALE   PALES			
SOL9513-148-15	14.75	15	R
SOL9513-145-17	14.5	17	R
SOL9513-143-19	14.25	19	R
SOL9513-140-21	14	21	R

INOX / SS	D	P	R
3 PALAS   BLADES   PALE   PALES			
SOL9571-158-15	15 <sup>3/4</sup>	15	R
SOL9572-158-15	15 <sup>3/4</sup>	15	L
SOL9571-155-17	15 <sup>1/2</sup>	17	R
SOL9572-155-17	15 <sup>1/2</sup>	17	L
SOL9571-153-19	15 <sup>1/4</sup>	19	R
SOL9572-153-19	15 <sup>1/4</sup>	19	L
SOL9571-150-21	15	21	R
SOL9572-150-21	15	21	L
SOL9571-148-23	14 <sup>3/4</sup>	23	R
SOL9572-148-23	14 <sup>3/4</sup>	23	L

INOX / SS	D	P	R
4 PALAS   BLADES   PALE   PALES			
SOL9531-145-15	14 <sup>1/2</sup>	15	R
SOL9532-145-15	14 <sup>1/2</sup>	15	L
SOL9531-143-17	14 <sup>1/4</sup>	17	R
SOL9532-143-17	14 <sup>1/4</sup>	17	L
SOL9531-140-19	14	19	R
SOL9532-140-19	14	19	L
SOL9531-140-21	14	21	R
SOL9532-140-21	14	21	L
SOL9531-140-23	14	23	R
SOL9532-140-23	14	23	L

REF	A	TIPO
SOLRBX-105	19	SX (1994+)



**RUBEX**

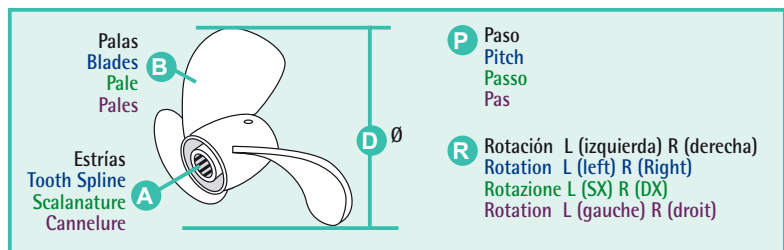

## HÉLICES ORIGINALES VOLVO

## VOLVO ORIGINAL PROPELLERS

## ELICHE ORIGINALI VOLVO

## HÉLICES ORIGINALES VOLVO

### AQUAMATIC, 200, 250, 270, 275, 280 Y 290

CUBO LARGO 11,5 cm		LONG HUB 11,5 cm		MOZZO DA 11,5 cm		MOYEU LONG 11,5 cm		CUBO ESTÁNDAR 9,5 cm		STANDARD HUB 9,5 cm		MOZZO STANDARD 9,5 cm		MOYEU STANDARD 9.5 cm	
REF	OEM	REF	OEM	D	P	REF	OEM	D	P	REF	OEM	D	P	REF	OEM
RM854977	854977	RM854992	854992	14	17	RM814626	814626	14	15	RM814631	814631	14	15	RM814627	814627
RM854978	854978	RM854993	854993	14	19	RM814628	814628	14	17	RM814632	814632	14	17	RM814628	814628
RM854979	854979	RM854994	854994	14	21	RM814628	814628	14	19	RM814633	814633	14	19	RM814628	814628
RM854982	854982	RM854997	854997	15	17	RM813316	813316	15	13	RM813317	813317	15	13	RM813316	813316
RM854983	854983	RM854998	854998	15	19	RM814611	814611	15	15	RM814615	814615	15	15	RM814611	814611
RM854984	854984	RM854999	854999	15	21	RM814612	814612	15	17	RM814616	814616	15	17	RM814612	814612
RM854986	854986			16	13										

REF	CONO	CONE	CONO	CONE
REC854045	ARANDELA	O-RING	RONDELLA	RONDELLE
REC850888	TORNILLO	SCREW	VITE	VIS

REF	CONO	THRUST WASHER	CONO	CONE
REC854045	ARANDELA	O-RING	RONDELLA	RONDELLE
REC854047	TORNILLO	SCREW	VITE	VIS

Para instalar hélices de cubo largo en colas 270, 275, 280 y 290 se necesitan:

Following parts are needed to install long hub props in drilled shaft 270, 275, 280 & 290 drives:

Per installare eliche con il mozzo lungo 11,5 cm nei piedi 270, 275, 280 e 290 servono:

Hélices avec moyeu long pour les embases avec arbre perforé 270, 275, 280, et 290 :

Para instalar hélices de cubo estándar en colas con nº de serie PZ2877179 se necesitan:

Following parts are needed to install standard hub props in drives with serial # PZ2877179:

Per installare eliche con il mozzo standard nei piedi con nº di serie PZ2877179 servono:

Nécessaire pour installer les hélices à moyeu std avec les embases N° de série PZ2877179 :

Las colas con nº de serie anterior a PZ2877179 se necesitan:

Earlier models to PZ2877179 need:

Per piedi con nº di serie precedente a PZ2877179 serve:

Nécessaire pour les embases avec N° de série antérieur à PZ2877179

### DUOPRO AL

### 3 +4

Esta tabla es orientativa, debe comprobarse con la documentación del motor.

This table is as orientation. Must be checked with the engine information

Questa tabella è come orientamento. Deve essere controllato con le informazioni del motore

Ce tableau est un guide et doit être vérifié avec la documentation du moteur.

GAS		DIESEL		HÉLICE DELANTERA FRONT PROPELLER ELICHE ANTERIORI HELICE AVANT	HÉLICE TRASERA REAR PROPELLER ELICHE POSTERIORE HELICE ARRIERE
KAD42, 43, 44, 300	B3			3 PALAS IZQUIERDA 3 BLADES LEFT 3 PALE SX 3 PALES GAUCHE	4 PALAS DERECHA 4 BLADES RIGHT 4 PALE DX 4 PALES DROITE
		A3			REC4-17ALU
		Altas prestaciones high performance Alte prestazioni Haute performance			REC4-19ALU
			A3		REC4-19ALU
B4					REC4-19ALU
			A4		REC4-19ALU
		Altas prestaciones high performance Alte prestazioni Haute performance			REC4-19ALU



RECMAR®



DP280, DP290, DP-A, DP-E

REF	OEM	RECmar®		VOLVO PENTA
		ANTIGUO TIPO OLD TYPE TIPO VECCHIO TYPE ANCIENNE	A	B
REC21924262	854814 854765 2194262 854815	2	1	2
REC21924263	854766 21924263 854816	3	2	3
REC21924264	854767 21924264 854817	4	3	4
REC21924265	854768 21924265 854769	5	4	5
REC21924266	854818 21924266 854819	6	5	6
REC21924267	854770 21924267 854820	7	6	7
REC21924268	854771 21924268 854821	8	7	8
REC21924269	854772 21924269 854773	9	8	9
REC21924270	21924270	10		10
BVA0990730A	854766	3		
BVA0990740A	854767	4		
BVA0990750A	854768	5		
BVA0990760A	854769	6		
BVA0990770A	854770	7		
BVB0990630A	854816		3	
BVB0990640A	854817		4	
BVB0990650A	854818		5	
BVB0990660A	854819		6	
BVB0990670A	854820		7	



Nuevo "Type J" sustituye al "Type A" y al "Type B"  
 New "Type J" replaces "Type A" and "Type B"  
 Il nuovo "Tipo J" sostituisce "Tipo A" e "Tipo B"  
 Le nouveau "Type J" se substitue au "Type A" et "Type B"



Para motores que excedan los 240HP o barcos de +38 knots se recomienda la instalación de hélices inox "Type C"  
 For engines exceeding 240HP or +38 knots, the installation of "Type C" stainless steel propellers is recommended  
 Per motori superiori a 240 HP o +38 nodi, si consiglia l'installazione di eliche in acciaio inossidabile "Tipo C"  
 Pour les moteurs supérieurs à 240 hp ou +38 nœuds, on recommande les hélices inox "type C".



DUOPRO INOX / SS  
 DP280, DP290, DP-G

3 +4

KAD42, 43, 44, 300	A2	C2	RECC2
B2			RECC2
			RECC2
	A3		RECC3
B3			RECC3
	A6		RECC6
	A7		RECC6
B6			RECC6
		C5	RECC6
B5	A4	C4	RECC5

Hélice delantera 3 palas izquierda  
 Hélice trasera 4 palas derecha  
 Front propeller 3 blades left  
 Rear propeller 4 blades right  
 Eliche anteriori 3 pale  
 Eliche posteriore 4 pale  
 Hélice avant 3 pales gauche  
 Hélice arrière 4 pales droite

Todos los motores  
 All engines  
 tutti motori  
 Tous les moteurs

RECmar®



DUOPRO AL  
 DPS & XDP

4 +4

REF	OEM
D2 / 12	RM3851482 3851482 21258482
D3 / 13	RM3851483 3851483 21258483
D4 / 14	RM3851484 21258484
D5 / 15	RM3856365 21258485
D6 / 16	RM3856366 3856366 21258486
D7 / 17	RM3856367 3856367 21258487

La nueva generación de hélices "Type I" sustituye al "Type D"  
 The new generation of propellers "Type I" replaces "Type D"  
 La nuova generazione di eliche "Tipo I" sostituisce "Tipo D"  
 La nouvelle génération d'hélice "Type I" se substitue au "Type D"



VOLVO PENTA

VOLVO

RECAMBIOS MARINOS

## S-DRIVE 110 / 120 / 130 / 150

REF	OEM	B	D	P	R
REC23478919	853583	2	17	16	LH
REC23478969	853588	3	17	14	LH

**RECMAR®**

REC23478919

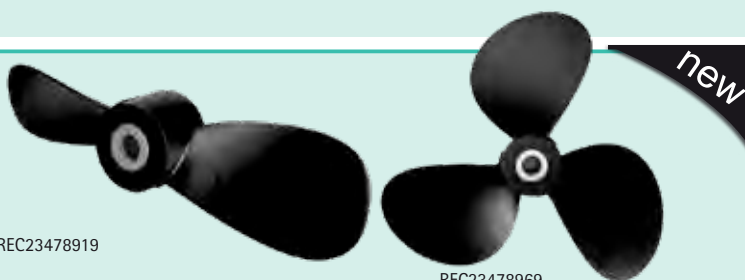

REC23478969

## DUOPRO NIBRAL DPH

3+4

Diseñado para capturar el tremendo par de los motores D4 y D6, la geometría de la pala patentada proporciona la interacción óptima entre las hélices delanteras y traseras para una eficiencia sobresaliente y un funcionamiento sin problemas. El gran área de la pala y la gran resistencia aseguran el máximo agarre y maniobrabilidad. La aleación nibrál (níquel-bronce-aluminio) extremadamente fuerte garantiza un crecimiento mínimo y una excelente durabilidad. Su completo aislamiento de goma y aislamiento galvánico lo hace perfectamente compatible con las hélices DPH.

Designed to capture the tremendous torque from the D4 & D6 engines, the patented blade geometry provides optimal interaction between front and rear propellers for outstanding efficiency and smooth and comfortable operation. The large blade area and great strength ensure maximum grip and maneuverability. The extremely strong nibrál (nickel - bronze-aluminium) alloy ensures minimum growth and excellent durability. Complete with shock-absorbing rubber brushing and galvanic isolation makes it perfectly matched for the DPH drives.

Progettata per ottimizzare la straordinaria coppia dei motori D4 e D6, la geometria della pala brevettata offre un'interazione ottimale tra eliche anteriori e posteriori per un'efficienza eccezionale ed un funzionamento fluido e confortevole. L'ampia area della pala e la grande robustezza garantiscono la massima aderenza e manovrabilità. La lega nibrál (nickel - bronzo - alluminio) estremamente robusta garantisce una crescita minima e un'eccellente durata. Completo di gomma ammortizzante e isolamento galvanico lo rende perfettamente abinabile ai DPH.

Conçue pour exploiter l'énorme couple des moteurs D4 et D6, la géométrie brevetée des pales assure une interaction optimale entre les hélices avant et arrière pour une efficacité exceptionnelle et un fonctionnement en douceur. La grande surface de la pale et sa grande résistance garantissent une prise en main et une manœuvrabilité maximales. L'alliage nibrál (nickel bronze aluminium) extrêmement résistant assure une déformation minimale et une excellente durabilité. Son isolation complète en caoutchouc et son isolement galvanique le rendent parfaitement compatible avec les embases DPH.

MOD.	REF	OEM
G4	REC22898644	22898644
G5	REC22898645	22898645
G6	REC22898646	22898646
G7	REC22898647	22898647

**VOLVO PENTA**



## KIT LLAVE HÉLICES DP

## DP PROP WRENCH KIT

## KIT CHIAVE ELICHE DP

## KIT CLÉ D'HELICE DP

REF	OEM
REC885195	885195



## ACEITE PARA MOTOR VOLVO

## VOLVO ENGINE OIL

## OLIO PER MOTORE VOLVO

## HUILE POUR MOTEUR VOLVO

### TRANSMISSION OIL

Las propiedades de lubricación protegen el accionamiento y la transmisión incluso bajo cargas pesadas. También proporciona una excelente protección contra la corrosión. Soporta altas temperaturas sin romperse.

Lubrication properties protect drive and transmission even under heavy load. Also provides excellent corrosion protection. Withstands high temperatures without breaking down.

Le proprietà di lubrificazione proteggono l'azione e la trasmissione anche sotto carico pesante. Offre inoltre un'eccellente protezione dalla corrosione. Resiste alle alte temperature senza rompersi.

Les propriétés lubrifiantes protègent l'entraînement et la transmission, même sous de fortes charges. Offre également une excellente protection contre la corrosion. Résiste à des températures élevées sans se dégrader.

REF	OEM	VISCOSIDAD VISCOSITA VISCOSITE	GRADO GRADE GRADE
REC3809445	3809445	5 L SAE 80W-90	API GL-5

**VOLVO PENTA**



## SYNTHETIC PETROL

Especialmente desarrollado para motores de alto rendimiento. Las propiedades especiales de este aceite le permiten lubricar el motor incluso durante el arranque a baja temperatura. El aceite combate la acumulación de lodo y brinda una excelente protección contra el desgaste. Especialmente adecuado para motores que están sujetos a arranques y paradas frecuentes.

Specially developed for high performance engines. The special properties of this oil allow it to lubricate the engine even during low temperature starting. The oil combats sludge build-up and gives excellent protection against wear. Particularly suitable for engines that are subject to frequent starting and stopping.

Sviluppato appositamente per motori ad alte prestazioni. Le proprietà speciali di questo olio consentono di lubrificare il motore anche durante l'avviamento a bassa temperatura. L'olio combatte il fango accumulato e offre un'eccellente protezione contro l'usura. Particolarmente adatto per motori soggetti a frequenti avviamenti e arresti.

Spécialement conçu pour les moteurs à haute performance. Les propriétés particulières de cette huile lui permettent de lubrifier le moteur même lors des démarrages à basse température. L'huile combat l'accumulation de boue et offre une excellente protection contre l'usure. Particulièrement adapté aux moteurs soumis à des démarrages et arrêts fréquents.

REF	OEM		VISCOSIDAD VISCOSITY VISCOSITA VISCOSITE	GRADO GRADE GRADE GRADE
REC21363429	21363429	1 L	SAE 5W40	API SM
REC21363430	21363430	5 L		

**VOLVO  
PENTA**



REC21363429



REC21363430

## VDS-3. MINERAL

VDS-3 cubre los requisitos más estrictos sobre la limpieza del pistón en comparación con VDS-2, lo que garantiza la durabilidad y fiabilidad de los motores. La alta calidad del aceite VDS-3 permite en ciertos casos un aumento en los intervalos de drenaje. Para motores diesel y de gasolina (ver manuales de los operadores).

VDS-3 covers even more stringent requirements on piston cleanliness and bore polish compared to VDS-2, ensuring the durability and reliability of the engines. The high quality of VDS-3 oil allows in certain cases an increase in drain intervals. Fits both diesel and gas engines (check operators manuals).

VDS-3 copre requisiti ancora più stringenti sulla pulizia del pistone e sulla lucidatura del foro rispetto a VDS-2, garantendo la durata e l'affidabilità dei motori. L'alta qualità dell'olio VDS-3 consente in certi casi un aumento degli intervalli di scarico. Adatto sia ai motori diesel che a quelli a gas (consultare i manuali degli operatori).

Le VDS-3 répond aux exigences les plus strictes en matière de propreté des pistons que le VDS-2, ce qui garantit la durabilité et la fiabilité des moteurs. La haute qualité de l'huile VDS-3 permet dans certains cas d'augmenter les intervalles entre les vidanges. Pour les moteurs diesel et essence (voir les manuels d'utilisation).

REF	OEM		VISCOSIDAD VISCOSITY VISCOSITA VISCOSITE	GRADO GRADE GRADE GRADE
REC22479638	22479638	1 L	SAE 15W40	Mineral oil VDS-3 API CI-4 ACEA E5
REC22479642	22479642	5 L		

**VOLVO  
PENTA**



## ATF-OIL, TYPE DEXRON III

Protege contra el desgaste, incluso a altas temperaturas. También proporciona muy buena protección contra la corrosión. NO DEBE USARSE DONDE SE RECOMIENDA API-GL5

Protects against wear, even at high temperatures. Also provides a very good corrosion protection. MUST NOT BE USED WHERE API-GL5 IS RECOMMENDED

Protegge dall'usura, sempre ad alte temperature. Fornisce anche un'ottima protezione contro la corrosione. NON DEVE ESSERE UTILIZZATO DOVE VIENE RACCOMANDATO API-GL5

Protège contre l'usure, même à haute température. Elle offre également une très bonne protection contre la corrosion. NE DOIT PAS ETRE UTILISÉ LÀ OÙ L'API-GL5 EST RECOMMANDÉ.

REF	OEM	
REC85122800	85122800	1 L
REC1161995	1161995	5 L

**VOLVO  
PENTA**



REC85122800



ATF-oil Type Dexron III  
REC1161995



## SYNTHETIC MARINE TRANSMISSION OIL

Aceite de transmisión marina de alto rendimiento diseñado para proporcionar la máxima protección para las colas Volvo Penta IPS y Aquamatic. Específicamente formulado para ofrecer un excelente rendimiento bajo cargas y temperaturas extremas a la vez que proporciona propiedades de fricción equilibradas entre agarre y deslizamiento y máxima protección contra el desgaste y la corrosión. La tecnología avanzada de los aditivos incluye una capacidad única para minimizar el daño debido a la contaminación del agua. Todo esto asegura ventajas significativas sobre los aceites de transmisión convencionales y contribuye a un funcionamiento suave y de alto rendimiento y a la salud a largo plazo de la cola.

High performance marine transmission oil designed to provide maximum protection for Volvo Penta IPS and Aquamatic stern drives. Specifically formulated to offer excellent performance under extreme loads and temperatures while providing balanced frictional properties between grip and slip and maximum protection against wear and corrosion. Advanced additive technology includes unique capability to minimize damage due to water contamination. All this ensures significant advantages over conventional transmission oils and contributes to high-performance, smooth operation and long-term health of the drive.

Olio per trasmissioni marine ad alte prestazioni progettato per fornire la massima protezione per Volvo Penta IPS e entrofuoribordo Aquamatic. Specificamente formulato per offrire prestazioni eccellenti in presenza di carichi e temperature estreme, fornendo al tempo stesso proprietà di attrito bilanciate tra aderenza e scivolamento e massima protezione contro l'usura e la corrosione. La tecnologia additiva avanzata include la capacità unica di minimizzare i danni dovuti alla contaminazione dell'acqua. Tutto ciò garantisce vantaggi significativi rispetto agli oli di trasmissione convenzionali e contribuisce a garantire prestazioni elevate, funzionamento regolare e integrità a lungo termine del piede.

Huile de transmission marine haute performance conçue pour offrir une protection maximale aux embases Volvo Penta IPS et Aquamatic. Spécifiquement formulé pour offrir d'excellentes performances sous des charges et des températures extrêmes tout en offrant des propriétés de friction équilibrées entre adhérence et glissement et une protection maximale contre l'usure et la corrosion. La technologie avancée des additifs comprend une capacité unique à minimiser les dommages dus à la contamination par l'eau. Tout ceci assure des avantages significatifs par rapport aux huiles de transmission conventionnelles et contribue à un fonctionnement souple et performant ainsi qu'à la santé de l'embase à long terme.

### IPS, Aquamatic

REF	OEM		VISCOSIDAD VISCOSITY VISCOSITÀ VISCOSITÀ
REC22479650	22479650	1 L	SAE 75W-90
REC22479648	22479648	5 L	

### DHP (ratio 1.59:1 (D6-400) DPG (KAD300)

REF	OEM		VISCOSIDAD VISCOSITY VISCOSITÀ VISCOSITÀ
REC22574246	22574246	5 L	SAE 75W-140

**VOLVO  
PENTA**



REC22479650

REC22479648

REC22574246

## NEUTRA-SALT

Dissuelve la sal de los depósitos. Previene el óxido y la corrosión (incluye un inhibidor de corrosión que deja una capa protectora en todas las superficies metálicas).

Dissolves salt and salt deposits. Prevents rust and corrosion (includes a corrosion inhibitor which leaves a protective coating on all metal surfaces).

Scioglie il sale dei depositi. Previene ruggine e corrosione (include un inibitore di corrosione che lascia uno strato protettivo su tutte le superfici metalliche).

Dissout the sel and ses dépôts. Préviént la rouille et la corrosion (comprend un inhibiteur de corrosion qui laisse une couche protectrice sur toutes les surfaces métalliques).

REF	OEM	
REC21687793	21687793 41103103	0.95 L
REC21687796	21687796 41103102	3.8 L

**VOLVO  
PENTA**



REC21687793

REC21687796

## COMPRESSOR OIL

Especialmente probado en compresores Volvo Penta. Completamente sintético, resiste temperaturas altas y bajas. Protege el compresor contra la corrosión.

Specially tested in Volvo Penta compressors. Fully synthetic oil that withstands both high and low temperatures. Protects compressor against corrosion.

Testati appositamente con i compressori Volvo Penta. Olio completamente sintetico che resiste alle alte e alle basse temperature. Protegge il compressore dalla corrosione.

Spécialement testé dans les compresseurs Volvo Penta. Entièrement synthétique, résiste aux températures élevées et basses. Protège le compresseur contre la corrosion.

REF	OEM		VISCOSIDAD VISCOSITY VISCOSITÀ VISCOSITÀ
RM85108974	85108974	250 ml	ISO VG 68

**VOLVO  
PENTA**





# REF --> OEM

REF	OEM	
<b>A</b>		
AM603905		408
AM603910		408
AM603915		408
AM603920		408
AM603930		408
AMITA 3 PLUS		586
AMITA3		586
<b>B</b>		
BAOMC-1-3858850P		511
BAOMC-20-3862603	3851227	522
BAOMC-20-3862603	3856617	522
BAOMC-20-3862603	3856662	522
BAOMC-20-3862603	3857684	522
BAOMC-20-3862603	3857798	522
BAOMC-20-3862603	3857810	522
BAOMC-20-3862603	3863071	511-522
BAOMC1-3852347	3852347	516-521
BAOMC20-910380	3850799	511-522
BAOMC29-910303	3854254	435
BRA125-1/2x1/2		370
BRA125-1/2x3/4		370
BRA125-1/2x3/8		370
BRA125-1/4x1/2		370
BRA125-1/4x3/8		370
BRA125-1x3/4		370
BRA125-3/16x1/4		370
BRA125-3/4x3/4		370
BRA125-3/8x1/2		370
BRA125-3/8x3/8		370
BRA125-5/16x3/8		370
BRA125-5/8x3/4		370
BRA125-5/8x3/8		370
BS2141	841178	408
BS2142	3854164	408
BS2143	3854186	408
BS5138		408
BS5139		408
BS5140		408
BS5141		408
BS5142		408
BS5143		408
BS5291		408
BS5292		408
BS5293		408
BS5294		408
BS5295		408
BS5296		408
BS5297		408
BS5298		408
BS5299		408
BVA0990730A	854766	589
BVA0990740A	854767	589
BVA0990750A	854768	589
BVA0990760A	854769	589
BVA0990770A	854770	589
BVB0990630A	854816	589
BVB0990640A	854817	589
BVB0990650A	854818	589
BVB0990660A	854819	589
BVB0990670A	854820	589
<b>C</b>		
CARP74021		375
CEF500100GX	875807	441
CEF500100GX	876689	441
CEF500100GX	3586494	441-448
CEF500100GX		449
CEF500103T	3854286	441-442
CEF500104	876120	347-440-442
CEF500105T	2170344	448-449
CEF500106GT	3841697	449
CEF500106GT	21951356	449
CEF500106GT		449
CEF500107T	21213660	442-449
CEF500114T	3588475	353-448-449
CEF500116GX	3593656	448
CEF500116GX	22222936	448
CEF500116GX	35993659	441
CEF500116GX		442-449
CEF500120T	835874	441
CEF500121GX	21951342	448-449
CEF500124	13554-0001	441
CEF500135	8777066	449
CEF500135	21951362	449
CEF500145T	875697	449
CEF500145T	875814	449
CEF500145T	21951364	449
CEF500162G	3887761	449
CEF500162G	21951358	449
CEF500162G		449
CEF500163G	3830459	448
CEF500170CG	875575	441-442-448-449
CEF500177GT	3593573	448
CEF500177GT	21730348	448
CEF500177GT		449
CEF500178G	21213664	353-441-442-448-449
CEF500207	21213660	448
CEF500380	3555413	448
CEF500505FL	876633	582
CEF500505K	875848	582
CEF500505K	876631	577-582
CEF500510K	875826	582-583

REF	OEM	
CEF500510K	876294	582-583
CEF500510K	897889	582-583
CEF500514K	3841481	582
CEF500514K	3854127	582
CEF500514K		578
CEF500528	3850426	578-582
CEF500530	858729	528
CEF500530	858955	528
CEF500530		524
CEF500531	860396	528
CEF500536K	3888916	355-582
CEF500537K	3594509	582
CEF500537K	3808898	582
CEF500537K		355
CEF500538K	3588753	354-582
CEF500538K	3808536	582
CEF500538K	3862168	582
CEF500538K		355
CEF501001	854932	576
CEF501001	22303438	535-576
CEF501011	875822	583
CEF501011	22303438	583
CHAP8Y		410
CHAPROSU		411
CHARD16		410
CHARJ12YC		410
CHARL82C		410
CHARL82YC		410
CHARL86C		410
CHARN7YC		410
CHARN9YC		410
CHARS12PYP		410
CHARS12YC		410
CHARS15LYC		410
CHARS9YC		410
CHARV15YC4		347-410
CHARV9YC		410
CHAV63C		410
CM21718129	21718129	567
CM21718129	21868042	567
CM21718129A		567
CM22651246	22651246	565
CM22651246	23615636	565
CM280DPKITA		568
CM280DPKITM		568
CM280KITA		568
CM280KITM		568
CM290DPKITA		567
CM290DPKITM		567
CM290KITA		568
CM290KITM		568
CM3588745	3588745	565
CM3588745A	3588745	565
CM3588746	3588746	566
CM3588746A	3588746	566
CM3593881	3593981	534-557-567
CM3593881A	3593981	567
CM3841427	3888816	566
CM3841427	3888817	566
CM3841427A	3888816	566
CM3841427A	3888817	566
CM3852970	3852970	566
CM3852970A	3852970	566
CM3854130	3854130	566
CM3854130A	3854130	566
CM3855411	3855411	566
CM3855411A	3855411	566
CM3858399	3858399	567
CM3858399A	3858399	567
CM3861634	3861634	537-566
CM3861634A	3861634	537-566
CM3861636	3861636	566
CM3861636A	3861636	566
CM3883728	3888813	566
CM3883728A	3888813	566
CM3888305	3888305	565
CM3888305A	3888305	565
CM40005206	40005206	567
CM40005206A	40005206	567
CM40005875	40005875	567
CM40005875A	23172856	557
CM40005875A	40005875	567
CM41100098	41100098	567
CM41100276	41100276	567
CM41100276P	41100276	567
CM823661	823661	567
CM823661A	823661	567
CM828140	873413	567
CM832598	832598	565
CM832598A	832598	565
CM832934	832934	566
CM838929	838929	567
CM838929A	838929	567
CM851983	876286	565
CM851983A	876286	565
CM852018	852018	566
CM852018A	852018	566
CM852019	8520219	566
CM852835	852835	565
CM852835A	852835	565
CM855105	855105	566
CM872139	872139	557-566
CM872139A	872139	557-566
CM872793	872793	566
CM872793A	872793	566

REF	OEM	
CM873395	873395	566
CM873395A	873395	566
CM873412	873412	567
CM875812	875812	565
CM875812A	875812	565
CM875821	875821	565
CM875821A	875821	565
CM876638	876638	557-566
CMCMV-18	875815	546-557-565
CMCMV-18A	875815	546-557-565
CMDPHKITA		568
CMDPHKITM		568
CMSXAKITA		568
CMSXAKITM		568
CMV-15	875810	557-565
CMV-16	875809	565
CMV-17	875805	546-565
CMV-17A	875805	565
<b>D</b>		
DAY17305	958481	469
<b>F</b>		
FEL17049		478
FEL17060		472-476
FEL17124		475
FEL17145		478-479
FEL17160		472
FEL17161		472
FEL17165		476
FEL17166		476
FEL17205		477
FEL17260		472-476
FEL17261		472-476
FEL17360		472-476
FEL17725		474-475
FEL17945		473-477
FEL17946		473-477
FEL17983		474-475
FEL17985	856889	478
FEL17986	3853510	478-479
FEL17995		473
FEL17996		476
FEL17997		473
FEL17998		476
<b>G</b>		
GDY15295	978457	468
GDY15335	966958	351-469
GDY15382	3852348	468
GDY15386	966870	352-469
GDY15545	966929	349-468
GDY17291	967158	467
GDY17291	9671587	469
GDY17291		346
GS11152	856659	396
GS30430		370
GS30431		370
GS30432		370
GS30433		370
GS31055		357-370
GS31056		357-370
GS31065		357
GS31066	22-89771Q2	357-370
GS31067		357
GS31157		357
GS35031		371
GS35032		371
GS35049		370
GS35050		370
GS35051		370
GS35052		370
GS35053		370
GS35054		370
GS35055		370
GS38103		584
GS38104		584
GS38320	3852604	511-5213-515-516-517
GS38322	3863443	513-515-516-517
GS90003		353
GS90005		353
GS90007		353
GS90012		353
GS90019		353
GS90029		353
GS90034		353
GS90090		353
GS90092		353
<b>H</b>		
HGE35908		512
HGE4532	824532	483-510-521
HGE5528	845528	524-527
HGE5599	825598	522
HGE5599	825599	510-522
HGE6894	841676	521
HGE6894	856137	521
HGE6894	856894	512-521
HGE7037	855380	522
HGE7037	856895	522
HGE7037	857037	512-522
HGE8870	3854045	520
HGE8870	3857450	520
HGE8870	3858870	511-520
HGE8870	3858871	520
HOT20930	834438	520

REF	OEM	
HOT20930	855387	510-520
HOT20930-MK		510
HOT20931	835804	521
HOT20931	855926	521
HOT20931	856883	514-521
HOT20931-MK		514
HOT20935	855384	523
HOT20935	856891	514-523
HOT20935-MK		514
HR TITAN 3 PROP		586

<b>J</b>		
JAB17018-0001	3593573	448
JAB17018-0001	21730348	448
JAB17018-0001		353-447-449
JAB17937-0001-P	3588475	446-448-449
JAB17938-0001-P	3830459	442-447-448
JOH09-1026B	3593656	448
JOH09-1026B	22222936	448
JOH09-1026B	35993659	441
JOH09-1026B		346-352-353-442-449
JOH09-1027B	21213660	442-448
JOH09-1027B		346-347-348-349-352-353-440
JOH09-1027B		347-348-349-352-353-440-442-443-445-449
JOH09-1028B	3841697	449
JOH09-1028B	21951356	449
JOH09-1028B		349-350-351-353-443-449
JOH09-1029B	2170344	350-448-449
JOH09-801B	875575	346-349-441-442-448-449
JOH09-806B	875807	441
JOH09-806B	876689	441
JOH09-806B	3586494	441-448
JOH09-806B		349-352-449
JOH09-808B	21951342	349-352-448-449
JOH09-812B	13554-0001	347-348-441-445
JOH09-814B	875697	449
JOH09-814B	875814	449
JOH09-814B	21951364	449
JOH09-819B	8777066	449
JOH09-819B	21951362	449
JOH09-819B		350-351-352
JOH09-821B	3887761	449
JOH09-821B	21951358	449
JOH09-821B		350-353-449
JOH10-24061-3	842843	444
JOH10-24130-3	838522	443
JOH10-24130-3	844971	443
JOH10-24268-4	858150	443
JOH10-24277-3	858469	444
JOH10-24707-01	840557	443
JOH10-24707-01	861009	443
JOH10-24707-01		452
JOH10-32058-1	831178	439-452
JOH10-32621-2	828026	439
JOH10-32621-2	855517	439
JOH10-32621-2	855578	439
JOH10-35098-3	829895	441-443
JOH10-35157-1	807368	443
JOH10-35157-1	833415	443
JOH10-35157-1	833883	443
JOH10-35157-1	840076	443
JOH10-35157-1	858065	443
JOH10-35157-1		452
JOH10-35157-3	807368	443
JOH10-35157-3	833415	443
JOH10-35157-3	833522	443
JOH10-35157-3	833883	443
JOH10-35157-3		452

<b>L</b>		
LENS3213	35-809097	357
LENS3227	35-886638	357
LENS3240		357
LUB11363		353
LUB11404		353

<b>M</b>		
MAR037	855380	522
MAR037	856895	522
MAR037	857037	512-522
MAR061	3854466	523
MAR061	3855270	523
MAR061	3856444	523
MAR061	3857402	523
MAR061	3861842	523
MAR061	3862198	523
MAR061	3863061	513-515-516-517-523
MAR061-MK		513-515-517

MAR261INOX	845261	526-527
MAR289	860656	524
MAR289	861289	524-527
MAR289INOX	860656	526
MAR289INOX	861289	526
MAR289INOX	861289	527
MAR345	859865	525
MAR345	861574	525
MAR345	3589544	525
MAR345	21424345	525-526-527
MAR499	3847499	513-521

REF	OEM	
MAR499	3852338	521
MAR499	3857656	521
MAR499	3857678	521
MAR501	3847501	515-521
MAR501	3852374	521
MAR501	3857723	521
MAR501-MK		515
MAR512	358251	527
MAR512	861413	525-527
MAR512	3582512	525
MAR512		526
MAR583	833583	525-527
MAR627	3862627	513-525-517-523
MAR627	3862904	523
MAR684	3588683	522
MAR684	3588684	511-522
MAR690	840690	524-527
MAR701INOX	3583856	526
MAR701INOX	3884701	526-527
MAR847INOX	21700014	526
MAR847INOX	22671214	526
MAR847INOX	22948847	526-527
MAR870	3854045	520
MAR870	3857450	520
MAR870	3858870	511-520
MAR870	3858871	520
MAR870-MK		511
MAR894	841676	521
MAR894	856137	521
MAR894	856894	512-521
MAR894-MK		512
MAR906	861906	524-527
MAR906	21190094	524
MAR930	840930	525-527
MAR963	859963	524-527
MAR963INOX	859963	526-527
MAR964	3889964	513-515-517-523
MAR964	3889965	523
MP0180-001	10-812509184	393-394
MP425024	3855805	518
MP425036	3855806	518
MP425113	3854100	518
MP426422	2850245	379
MP426422	3854346	379
MP426422	3858331	379
MP426422	3859066	379
MP426422	21610334	379
MP426574	3855279	379
MP426766	3855957	379

<b>N</b>		
NEW SATURN		586
NGKBP7HS		346-411
NGKBP6EFS		347-348-411
NGKBP6EIX		411
NGKBP6RES		346-411
NGKBP6RES		411
NGKBP7EIX		411
NGKBP7RES		346-411
NGKBR6FIX		347-411
NGKBR6FS		411
NGKBR6FS		346-347
NGKIZTR5B11		348
NGKTR5		411
NGKTR55		411
NGKTR55IX		411
NGKTR5IX		411
NGKTR6IX		411
NGKUR4		411
NGKUR4IX		411
NGKUR5		411
NGKUR6		346-411
NGKUR6IX		411
NGKUR6IX		347-348
NGKXR5		411
NGKYR5		346
NGKYR5		411
NGKYR5IX		411

<b>P</b>		
PRE3300C05	21633476	531
PRE3300C06	21633477	531
PRE3300C07	21633478	531
PRE3300C08	21633479	531
PRE3300C09	21633480	531
PRE3300C10	21633481	531
PRE3300C11	21633482	531
PRE3300C12	21633483	531
PRE3300C13	21633484	531
PRE3300C14	21633485	531
PRE3300C15	21633486	531
PRE3300C16	21633487	531
PRE3300C17	21633488	531
PRE3300C18	21633489	531
PRE3300C19	21633490	531
PRE3300C20	21633491	531
PRE3300C21	21633492	531
PRE3300C22	21633493	531
PRE3300C23	21633494	531
PRE3300C24	21633495	531
PRE3300C25	21633496	531
PRE3300C26	21633497	531
PRE3300C27	21633498	531
PRE3300C28	21633499	531

REF	OEM	
PRE3300C29	21633500	531
PRE3300C30	21633501	531
PRE3300C31	21633502	531
PRE3300C32	21633503	531
PRE3300C33	21633504	531
PRE3300C34	21633505	531
PRE3300C35	21633506	531
PRE3300C36	21633507	531
PRE3300C38	21633509	531
PRE3300C40	21633511	531
PRE3300C42	21633513	531
PRE3300C44	21633515	531
PRE3300C46	21633517	531
PRE3300C48	21633519	531
PRE3300C50	21633521	531
PS111044		353

<b>R</b>		
RAC1/2F-1/2M		370
RAC1/2X16		370
RAC1/2X18		370
RAC1/2X20		370
RAC1000MA30		362
RAC1000VMA		362
RAC120AS		363
RAC120R-RAC-01		357
RAC2010PM-OR		362
RAC2010SM-OR		362
RAC2010TM-OR		362-364
RAC2020PM-OR		362
RAC2020SM-OR		362
RAC2020TM-OR		362
RAC2040PM-OR		362
RAC2040SM-OR		362
RAC2040TM-OR		362
RAC230R2		363
RAC245R2		363
RAC3/8F-3/8M		370
RAC3/8X10		370
RAC3/8X12		370
RAC3/8X14		370
RAC320R-INOX-01		357
RAC320R-RAC-01		357
RAC320R-RAC-02		357
RAC460R2		363
RAC490R2		363
RAC500MA30		362
RAC75/1000MA30		362
RAC75/500MAX		362
RAC900MA30		362
RAC900VMA		362
RACPF5510		356
RACR11T		363
RACR12		364
RACR120P		363
RACR120SM		363
RACR120TM		363
RACR12P		363
RACR12S		363
RACR12T		363
RACR20P		363
RACR20S		363
RACR20T		363
RACR24P		363
RACR24S		363
RACR24T		363
RACR25P		363
RACR25S		363
RACR25T		363
RACR26P		363
RACR26S		363
RACR26T		363
RACR60P		363
RACR60S		363
RACR60T		363
RACR90P		363
RACR90S		363
RACR90T		363
RACRK19492UL		371
RACRK20726		371
RACRK22628		371
RACS3213	35-809097	357
RACS3214	35-809099	357
RACS3220UL		357
RACS3227	35-886638	357
RACS3228UL	857633	357-358
RACS3240		357
REC0307239	3852071	426
REC062MINORKIT		446-456
REC0987883	3854194	393-406
REC10-37612	3853155	516
REC10-37612	3855983	516-517
REC10-861788	10-861788	393-394
REC10615K	835874	441
REC1066823		467
REC11-859135	3852648	403-543-544-578-579
REC11043	11043	539
REC11044	11044	547-549-551
REC11065	11065	539
REC11072	11072	546-547
REC11096	11096	539
REC1140639		364
REC1161995	1161995	591
REC11994	11994	378-422



REF	OEM		REF	OEM		REF	OEM	
REC11994	18839	422	REC1544119	1544119	491-509	REC19876		401
REC11994	110386	422	REC1545198	1545198	509-518-519-520	REC20450736	20450736	425
REC11994	233033	422	REC16-70236	3853373	511	REC20513285	20513285	519
REC11994	243621	422	REC160ELEMMENT		364	REC20707685	860105	494
REC11994	859851	422	REC1660609	181670	437	REC20707685	20707685	494
REC11994	859853	422	REC1660609	1660609	437	REC20739057	20739057	519
REC11994	861835	422	REC1674083	463828	451	REC207MINORKIT		455
REC11994	3580629	422	REC1674083	1357775	451	REC207MINORKIT		457
REC11994	6603088	422	REC1674083	1674083	451	REC207MINORKIT		457
REC11994	6604939	422	REC1674083	1674084	451	REC207MINORKIT		447-457
REC120		364	REC1674083	3850064	451	REC21112496	21112496	535-572
REC121152		490	REC1676432	421174	437	REC21112497	21112497	535-572
REC121153		490	REC1676432	1545283	437	REC21124849	21124849	388-472
REC121154		490	REC1676432	1665527	437	REC21132189	3584126	373
REC1218630	418423	518	REC1676432	1674032	437	REC21132189	21132189	373
REC1218630	1218630	519	REC1676432	1676432	437	REC21132390	3861034	347-348-466-468
REC124240-01883	862583	452	REC1676432	15442883	437	REC21132392		347-466
REC125017	125017	355-545-555-556-573	REC17000		470	REC21134777	833323	373
REC12532	841244	415	REC17010		471	REC21134777	21134777	373
REC126870	3852020	548-571	REC17020	3853380	473	REC21139810	21139810	360
REC1275379	940096	378	REC17030	3853380	474	REC21141637	3593656	445
REC1275379	1275379	378	REC17040	856575	477	REC21141637	3884694	445
REC1275379		509	REC17042	3853511	477	REC21141637	21141637	445
REC1276425	1276425	498	REC17048	3853587	478	REC21160912	21160912	469
REC127695-35150	423135	367	REC17102		470	REC21165389	3581868	486
REC127695-35150	4785974	367	REC17116		471	REC21165389	21165389	486
REC127695-35150		350-351-352	REC17120		473-475	REC21165390	3581869	486
REC128670	128670	571	REC17125		473-475	REC21165390	21165390	486
REC13-35048	3852002	513-515-516-517	REC17140		477	REC21171277	3881586	366
REC1302		377	REC17146		478-479	REC21171277	3886591	366
REC13037		406	REC17200		470	REC21171277	3889484	366
REC1306169	1306169	413	REC17207		479	REC21171277	21171277	366
REC1306341	1306341	508	REC17210		471	REC21171277		353
REC1306630	1306630	507-509-518	REC17211		471	REC21192875	1665251	369
REC1317761	1317761	508	REC17214		474	REC21192875	2053237	369
REC1317761	1326239	508	REC17220		473	REC21192875	21192875	369
REC1317792	1317792	518	REC17224		473	REC21192973	3840843	486
REC1317793	1317793	518	REC17230		474	REC21192973	21192973	486
REC1324492	1324492	407	REC17232		475	REC21192974	3889517	486
REC1324750	1324750	389	REC17240		477	REC21192974	21192974	486
REC1336385	1336385	390	REC17242		477	REC21196919	3885441	365
REC1336763	1336763	508	REC17243		477	REC21196919	21196919	365
REC13554-0001	13554-0001	441	REC17248		479	REC21212799	3812519	440
REC1359649	1359649	531	REC17253	17253	555-556	REC21212799	21212799	440
REC1359649	22297931	531	REC17276	17276	355-539-555-556	REC21212800	3812518	441
REC1359649	22797782	531	REC17310		471	REC21212800	21212800	441
REC1378491	1378491	435	REC17320	856365	473-475	REC21213660	21213660	439-440-442-448-448
REC1378491	1378491	435	REC17340	856616	478-518			448-448
REC1378492	463829	482	REC17341		478-479			439-440-441-442-448-449
REC1378492	1378492	482	REC17342		479	REC21213664	21213664	442-448-449
REC1378493	463359	481	REC1766160		364	REC21214599	3812693	439
REC1378493	1276817	481	REC17900		471	REC21214599	3857202	439
REC1378493	1378493	481	REC17903		471	REC21214599	3862482	439
REC1378645	463412	480	REC17920		472	REC21214599	21214599	439
REC1378645	31378645	480	REC17921		472	REC21214599		450
REC1378646	1326785	480	REC17930	835096	474-476	REC21214601	3812695	440
REC1378646	1332644	480	REC17931	3852687	474-476	REC21214601	3860795	440
REC1378646	1378646	480	REC17935	856626	478-479	REC21214601	3862484	440
REC1378646	1378646	480	REC17937	3853513	478-479	REC21214601	21214601	440
REC1378853	1378853	482	REC17937-0001	3588475	448-449	REC21214601		450
REC1378854	1378854	482	REC17971		472	REC21219723	21219723	447-456
REC1378864	418262	483	REC17980	855729	474-475	REC21250645	3808796	389
REC1378864	463587	483	REC17981		474-475	REC21250645	21250645	389
REC1378864	1378864	483	REC17982	3856138	474-475	REC21256410	3843471	584
REC1378870	1336753	482	REC18-5295		419	REC21256410	3889982	584
REC1378870	1378870	482	REC18-8114		380	REC21256410	21256410	544-584
REC1378879	463225	482	REC18-8115		380	REC21280913	3809465	465
REC1378879	1266796	482	REC181538	181538	437	REC21280913	3848896	465
REC1378879	1378879	482-510	REC181620	181620	555	REC21280913	3883786	465
REC1378909	1378909	482	REC181717	181717	451	REC21280913	21127053	465
REC1378911	418870	483	REC181804	181804	539	REC21280913	21280913	465
REC1378911	1378911	483	REC183247	183247	540-541-543-544-545	REC21302969	21302969	394
REC1378913	461092	482-512	REC183247		544-545	REC21310068	21310068	519
REC1378913	1378913	482	REC183247	3850853	537	REC21323043	3583555	394
REC1378914	461113	483	REC183272	183272	537-547-549-551-552-554-546-547	REC21323043	3801351	394
REC1378914	1378914	483	REC183374	183374	546-547	REC21323043	3803929	394
REC1396-4656	3854106	382-383	REC183390	183390	546	REC21323043	21323043	394
REC1396-5238	3854107	382-379-383	REC183390	183390	539	REC21325767	865013	525
REC1397-3327		381-383	REC183390	184642	539	REC21325767	3807212	525
REC13980	3850802	511	REC183391	183391	555	REC21325767	3838942	525
REC1463-9382	835998	409	REC183765	183765	539	REC21325767	3884701	527
REC15-404	875571	412	REC183859	183859	537-547-549-551-552	REC21325767	21325767	525
REC15-405	3888324	412-416-420	REC183859	183859	551-552	REC21325767		527
REC15-601	3888325	412-416-429	REC183859	183959	554	REC21351717	21274700	377
REC15-604	3857166	412	REC183861	183861	451	REC21351717	21351717	377
REC15-606	3888327	412-417-421	REC184654	184654	539-547-549-551-552-554	REC21351717	85113732	377
REC15-801	3857166	412	REC184654		551-552-554	REC21351717	85116162	377
REC15-804	3888326	412-417-420	REC184682	184682	547-549-551	REC21363429	21363429	591
REC15-806	3857166	412	REC184683	184683	537-551-552-554	REC21363430	21363430	591
REC15-808	3861295	412	REC184683	184683	547-549	REC21368879	21368879	369
REC15-815	3888328	412-418-421	REC184765	184765	537-547-549-551-552	REC21371111	3588433	489
REC1504952	1504952	406-407	REC184778	184778	539	REC21371111	21371111	489
REC1504952	3858809	407	REC184778		539	REC21371111		486
REC1542052	1542052	492	REC18525A1	854531	399	REC21371112	3588432	488
REC1542123	1542123	493	REC18777-0001		442	REC21371112	21371112	488
REC1542123	1542177	493	REC18818	18818	378	REC21379102	21106041	445
REC1542157	1542157	378	REC19029		575	REC21379102	21379102	445
REC1542158	1542158	378	REC19035		571	REC21379288	21141341	365
REC1542159	18671	378	REC19037	876266	571	REC21379288	21379288	365
REC1542159	1542159	378		+876268	572	REC21379288		353
REC1542187	1542187	422-426	REC19088		402	REC21380886	3819485	447
REC1542318	1542318	498	REC191844	191844	577	REC21380886	3836314	447
REC1542389	1542389	509-518	REC192212	192212	508	REC21380886	21380886	447
REC1542472	1542472	509-518	REC192212	463904	508	REC21380886		456

REF	OEM		REF	OEM		REF	OEM	
REC21380890	3584063	446	REC21880386	21641712	430	REC22122		427
REC21380890	3589907	446	REC21880386	21880386	430	REC22123		427
REC21380890	21380890	446	REC21913334	21687472	367	REC22124		427
REC21380890		456	REC21913334	21913334	367	REC22125		438
REC21400091	873765	407	REC21921545	21921545	501	REC22126		438
REC21400091	11305263	407	REC21924262	854765	589	REC22127		432
REC21400091	21400091	407	REC21924262	854814	589	REC22128		432
REC21403633	21403633	348-558-559	REC21924262	2194262	589	REC22134		494
REC21405493	21405493	469	REC21924263	854766	589	REC22143		432
REC21407028		467	REC21924263	854815	589	REC22145		512
REC21412639	21412639	425	REC21924263	21924263	589	REC22148		427
REC21419374	21419374	446-456	REC21924264	854767	589	REC22149		432
REC21419376	21419376	446-456	REC21924264	854816	589	REC22151	573-574	
REC21423488	874501	395	REC21924264	21924264	589	REC22152		432
REC21423488	3588491	395	REC21924265	854768	589	REC22153		432
REC21423488	3801296	395	REC21924265	854817	589	REC22154		431
REC21423488	3803648	395	REC21924265	21924265	589	REC22155		427
REC21423488	3803855	395	REC21924266	854769	589	REC22156		427
REC21423488	3803938	395	REC21924266	854818	589	REC22161		580
REC21423488	3804296	395	REC21924266	21924266	589	REC22163		580
REC21423488	21423488	395	REC21924267	854770	589	REC22167		453
REC21426987	20513343	392	REC21924267	854819	589	REC22169		402
REC21426987	21426987	392	REC21924267	21924267	589	REC22170		530
REC21436799	21436799	409	REC21924268	854771	589	REC22171		530
REC21450768	3583915	526	REC21924268	854820	589	REC22171036	3861556	530
REC21450768	3819016	526	REC21924268	21924268	589	REC22171036	3582692	465
REC21450768	21450768	526-527	REC21924269	854772	589	REC22171036	3588305	465
REC21457172	3582986	430	REC21924269	854821	589	REC22171036	3847481	465
REC21457172	3583338	430	REC21924269	21924269	589	REC22171036	3883784	465
REC21457172	3809070	430	REC21924270	854773	589	REC22171036	21786692	465
REC21457172	3809071	430	REC21924270	21924270	589	REC22171036	22171036	465
REC21457172	3889148	430	REC21945911	3884410	404	REC22172		402
REC21457172	21457172	430	REC21945911	21945911	404	REC22185019	876527	502
REC21484383	3841840	400	REC21951302	21951302	451	REC22185019	877071	502
REC21484383	21484383	400-579	REC21951368	21951368	443-454	REC22185019	22185019	502-509
REC21492771	466987	360	REC21951414	21951414	443-454	REC22185027	876851	502
REC21492771	829993	360	REC21951422	21951422	443-454	REC22185027	3581714	502
REC21492771	3825133	360	REC22-428611	3852135	513-515-516-517	REC22185027	3817034	502
REC21492771	21492771	360			535-543-544-	REC22185027	22185027	502
REC21492771		349-350-351-353	REC22-67892A05	3854539	548-552-553	REC22185027		509
REC21533394	854256	382	REC22-73379	3850740	513-515-516-517	REC22187385	3779955	401-402
REC21533394	21533394	382	REC22005			REC22187385	3889955	401-402
REC21533394		379-383	REC22008		510	REC22187386	3779955	401
REC21585053	21585053	465	REC22009		460	REC22187386	3889955	401
REC21608512	3594785	374	REC22011	876224	453	REC22187386		402
REC21608512	21397772	374	REC22012		460	REC22188	3850984	571
REC21608512	21545139	374	REC22013		459	REC22189	3850984	571
REC21608512	22608512	374	REC22014		435	REC22206133	420641	494
REC21608512	23386773	374	REC22015		434	REC22206133	466393	494
REC21608512	23794966	374	REC22016		429	REC22206133	22206133	494
REC21622232	21622232	419-421	REC22017		454	REC22256171	3861068	581
REC21632901	21632901	368	REC22019		460	REC22256171	22256171	534-581
REC21632901	22030852	368	REC22021		460	REC22256171		534
REC21632901		353	REC22022		432	REC22273952	3762385	584
REC21646645	3582358	365	REC22024		460	REC22273952	3862385	539
REC21646645	21646645	365	REC22025		460	REC22273952	22273952	539-584
REC21646645	21782391	365	REC22032		460	REC22283751	22283751	469
REC21646645		349-350-353	REC22033		427	REC22303438	854932	354-576
REC21655254	3587046	430	REC22034		427	REC22303438	22303438	354-535-576
REC21655254	3594159	430	REC22037		493	REC22314183	828726	400
REC21655254	3594161	430	REC22038		429-459	REC22314183	873531	400
REC21655254	3809093	430	REC22039		434	REC22314183	22314183	400-577
REC21655254	3809097	430	REC22040		435	REC22336734	3852329	537
REC21655254	21610728	430	REC22042		453			539-541-543-
REC21655254	21655254	430	REC22045		453	REC22336734	22336734	544-545-555-556
REC21662702	21662702	450	REC22047		512	REC22352491	22352491	469
REC21687793	21687793	592	REC22051		453	REC22372721	22372721	361
REC21687793	41103103	592	REC22053		459	REC22372721	22372721	361
REC21687796	21687796	592	REC22054		453	REC22389354	876261	502
REC21687796	41103102	592	REC22055		453	REC22389354	876784	502
REC21702999	3583654	366	REC22057		580	REC22389354	876819	502
REC21702999	3818541	366	REC22059		580	REC22389354	876834	502
REC21702999	21702999	366	REC22060		580	REC22389354	22389354	502
REC21702999		353	REC22061		580	REC22389354		509
REC21707132	471392	368	REC22063494	22063494	459	REC22393048	3580305	507-518
REC21707132	477556	368	REC22070		447-456	REC22393048	3580306	507
REC21707132	21707132	368	REC22072		432	REC22393048	22393048	507-519
REC21707134	466634	367	REC22073		453	REC22430456	22430456	554
REC21707134	21707134	367	REC22074		454	REC22452005	21745119	529
REC21707134		351-352	REC22075		580	REC22452005	22452005	529
REC21711728	21711728	503	REC22077		580	REC22452005		530
REC21721548	3809559	405	REC22078		427	REC22479638	22479638	591
REC21721548	21721548	405	REC22085		574	REC22479642	22479642	591
REC21721550	3809560	405	REC22086		546-573	REC22479648	22479648	534-592
REC21721550	21721550	405	REC22087		547-573	REC22479650	22479650	592
REC21730344	21730344	448	REC22089		454	REC22574246	22574246	592
REC21730344	8777066	449	REC22097		575	REC22582994	3586857	503
REC21730344	21951362	449	REC22103		429	REC22582994	22582994	503
REC21730344		447-449-454-455	REC22104		432	REC22612828	22612828	554-574
REC21760		485-488	REC22105		428	REC22637542	846762	407
REC21761		485-488	REC22106		428	REC22637542	860339	407
REC21762		486-488	REC22107		428	REC22637542	873740	407
REC21763		486-489	REC22108		428	REC22637542	22637542	407
REC21764		486-489	REC22109		428	REC22651246	3888305	535
REC21765		486-489	REC22110		431	REC22651246	22651246	560
REC21765		486-489	REC22111		431	REC22651246	22651246	557-559
REC21766		495-497	REC22113		460	REC22651246		558
REC21840806	3857470	401	REC22114		460	REC22651246AL	3888305	535-557-558-559
REC21840806	3888301	401	REC22115		460	REC22651246AL	22651246	560
REC21840806	21840806	401	REC22116		460	REC22663814	21146097	529
REC21840806		402	REC22119		493	REC22663814	21505553	529
REC21849843	21849843	495	REC22120		493	REC22663814	22663814	529
REC21868042	21868040	560	REC22120-0001	876120	346-347-442	REC22774756	3582694	465
REC21868042AL	21868042	560	REC22121		493	REC22774756	3583665	465
REC21880386	860631	430	REC22121309		401-402	REC22774756	21344508	465



REF	OEM		REF	OEM		REF	OEM	
REC22774756	22774756	465	REC27-807473A1	3857662	474-475	REC3580309	3580309	485
REC22774756		467	REC27-8079821	841031	380	REC3580380	3580380	452
REC22898644	22898644	590	REC27-8146801	3852096	426-435	REC3580380	3580917	452
REC22898645	22898645	590	REC27-815528	3853256	471-511	REC3580509	3580509	352-353-366
REC22898646	22898646	590	REC27-99757	856116	512	REC3580510	3580510	366
REC22898647	22898647	590	REC27-99757	3853412	513	REC3580514	3580514	426
REC22905150	3886848	447	REC27-99757		471	REC3580586	3580586	498
REC22905150	22905150	447	REC270136	270136	500	REC3580835	3580835	469
REC22905150		457	REC270137	270137	500	REC3581078		346-347-349-364
REC22905155	3589104	447	REC270906	270906	500	REC3581528	3581528	384
REC22905155	22905155	447	REC270907	270907	500	REC3581536	3581536	377-509
REC22905155		457	REC271051	271051	500	REC3581621	861474	366
REC22915955	22915955	501	REC271054	271054	500	REC3581621	861475	366
REC22954700	22954700	469	REC271063	271063	500	REC3581621	3581621	366
REC23008		574	REC271214	271214	500	REC3581621	21549544	366
REC23009		572	REC271215	271215	500	REC3581621		349
REC23010		539-575	REC271217	271217	500	REC3581696	3581696	376
REC23011		426	REC271218	271218	500	REC3581760	3581760	362-364
REC23012		426	REC271975	271975	433-435	REC3581774	188486	395
REC23013		426	REC271975	1275148	433	REC3581774	3581774	395
REC23014		431	REC271975	3547560	433	REC3581774	8599252	395
REC23015		427	REC272002	272002	499	REC3581774		406
REC23018		539-573	REC272004	272004	499	REC3581889	3581889	519-520
REC23019		575	REC272040	272040	499	REC3582310	860320	373
REC23020	3888822	552-574	REC272059	272059	499	REC3582310	1542170	373
REC23022	3888821	553-574	REC275331	275331	500	REC3582310	3582310	373
REC23024		537-575	REC275334	275334	499	REC3582324	3582324	465-467
REC23025		537-574	REC275336	275336	499	REC3582432	838628	486
REC23027		572	REC275337	275337	500	REC3582432	858993	486
REC23033		573	REC275338	275338	500	REC3582432	3582432	486
REC23034		545-575	REC275340	275340	499	REC3582432		509
REC23035		445-454	REC275341	275341	499	REC3582435	876103	488
REC23038		445-455	REC275344	275344	499	REC3582435	876121	488
REC23048		426	REC275350	275350	503-509	REC3582435	3582434	488
REC23059414	23059414	436-437	REC275369	275369	500	REC3582435	3582435	488
REC23120		570	REC275751	275751	501	REC3582435		486
REC23164609AL	3888813	552-553-554-557-558-559	REC275751	275751	501	REC3582500	859844	373
REC23164611AL	3888816	557-559-579	REC275751	875651	501	REC3582500	3582458	373
REC23164611AL	3888817		REC275751		509	REC3582500	3582500	373
REC23164611AL	23164611		REC288MINORKIT		446-456	REC3582561	419653	518-519
REC23164611AL		559	REC294005		420	REC3582561	3582561	509-520
REC23170		555-570	REC296TWIN		364	REC3582563	876108	494
REC23172849	876286	546-557	REC30-879194A01	21752712	578	REC3582563	876312	494
REC23172849	23172849	534	REC300-00879	3852217	409	REC3582563	3582563	494
REC23172849	40005875	534	REC30650525	30650525	486	REC3582563		383-384
REC23172849		534-558-559	REC30677767	30677767	434	REC3582595	876398	494
REC23172849AL	23172849	534-557-559	REC30713459	30713459	490	REC3582595	3582595	494
REC23172849AL	40005875	534	REC30729340	30729340	492	REC3582595		383-384
REC23172849AL		557-558	REC30731261	30731261	486	REC3582596	875633	489
REC23478919	853583	590	REC30731262	30731262	486	REC3582596	875662	489
REC23478969	853588	590	REC30731263	30731263	486	REC3582596	876395	489
REC23553896	23553896	573	REC30731264	30731264	486	REC3582596	3582596	489
REC23557470	859111	494	REC30731809	30731809	353-467-469	REC3582596		486
REC23557470	3581570	494	REC30788490	30788490	368	REC3582597	875031	488
REC23557470	3582676	494	REC309731	3852537	578	REC3582597	876453	488
REC23557470	22557470	494			535-537-548-	REC3582597	3582597	488
REC238258	238258	412	REC31-66668A1	3854249	549-551-552-	REC3582597		486
REC2394207AL	3584442	561	REC31-86748A1	183512	553-554	REC3582606	419652	518
REC23974207AL		561	REC31-86748A1	3854250	548-549-552-	REC3582606	3582606	520
REC241669	241669	412			553-554	REC3582608	1378960	518
REC243658	243658	412	REC31-86748A1	6854250	537	REC3582608	3582608	520
REC243797	243797	413	REC31216308	31216308	387	REC3582609	463371	518
REC243799	243799	413	REC31251252	30637961	465	REC3582609	3582609	520
REC243799		413	REC31251252	30757056	465	REC3582639	3582639	430
REC243903	243903	413	REC31251252	31251252	465	REC3582725	3582725	492
REC24942		356	REC31339213	31339213	498	REC3582732	3582732	368
REC24950		356	REC31359568	30731772	464	REC3582732	22030848	368
REC24952		356	REC31359568	31258305	464	REC3582732		353
REC25-30613		355	REC31359568	31359568	464	REC3582748	3582748	498
REC25-33145	3852044	578	REC31359568	31359568	464	REC3582887	3582887	535
REC25000		356	REC31419556	30659131	397	REC3582888	3582888	535
REC25010		356	REC31419556	30667118	397	REC3583073	3583073	376
REC25020		356	REC31419556	31419556	397	REC3583078	3583078	378
REC25030		356	REC31430317	30777600	491	REC3583078	3887602	378
REC26-14756		478-479	REC31430317	31430317	491	REC3583087	3583087	437-438
REC26-34217	3854956	507	REC3183211	3183211	519	REC3583089	3583089	445
REC26-34217	3854956	507	REC3287677	3287677	409	REC3583115	860629	444
REC26-75988	3853521	507	REC3302-9031		381-383	REC3583115	860827	444
REC26-8M0150312	3857648	507	REC331188	3852169	578	REC3583115	3583115	444
REC26-8M0150312	3862362	507	REC332583	3852523	578	REC3583115	3583115	444
REC2656613		364	REC35-06003	835440	359	REC3583322	3583322	535
REC26900		419	REC35-06003	3852030	359	REC3583336	3583336	492
REC26901		419	REC35-06003	3852412	359	REC3583443	3583443	361
REC26904		419	REC35-06003		348	REC3583443	21718912	361
REC26905		419	REC35-06003		346-347	REC3583443		353
REC2696		380	REC35-06007	835779	359	REC3583546	3583546	491
REC27-142471		472	REC35-53336	835576	358	REC3583647	3583647	428
REC27-33395	856034	474-514	REC35-802893Q		356	REC3583700	3583700	498
REC27-33395	3852468	515	REC35-802893Q01		356	REC3583780	3583780	426
REC27-33395		475	REC35-802893Q01		372	REC3583786	858992	486
REC27-33918	835417	426	REC3501530	3501530	375	REC3583786	876853	486
REC27-33918	3852111	426-436	REC3514432	3514432	507	REC3583786	3580742	486
REC27-33956	3853342	434-435	REC3517857	418432	359-366	REC3583786	3582433	486
REC27-34897	3852477	435-436	REC3517857	430143	359-366	REC3583786	3583786	486
REC27-41609	27-41609	380	REC3517857	1266286	359-366	REC3583787	876104	509
REC27-46820	3852472	517	REC3517857	3517857	359-366	REC3583787	876530	489
REC27-46820	3852472	478-479	REC3517857		346-349	REC3583787	3582436	489
REC27-49110	3853361	435	REC3517857		507-518	REC3583787	3583787	489
REC27-56880	3852824	434-436	REC3517893	3517860	389	REC3583787		486
REC27-60715	27-60715	380	REC3545696	3545696	498	REC3583788	3582437	489
REC27-65577	27-65577	380	REC3580026	3580026	373	REC3583788	3583788	489
REC27-70142	27-70142	380	REC3580100	3580100	495	REC3583788		486
REC27-803192A2	24-803192A2	434	REC3580227	3580227	485	REC3583840	3583840	430

REF	OEM		REF	OEM		REF	OEM	
REC3583840	21219693	430	REC3808898	3808898	539-582	REC3849006	3849006	539
REC3583913	1542198	422-457	REC3809167	840270	485	REC3850268	3850268	468
REC3583913	3583913	422-437-457	REC3809167	859136	485	REC3850360	3850360	423-436
REC3584062	3584062	446-456	REC3809167	860749	485	REC3850396	3850396	387
REC3584127	3584127	405	REC3809167	3809167	485	REC3850397	3850397	390
REC3584144	3584144	369	REC3809445	3809445	590	REC3850426	3850426	354-355-578-582
REC3584145	3584145	353-369	REC3809647	3809647	485	REC3850495	3850495	511
REC3584167	3584167	526-528	REC3809657	3809657	491	REC3850559	3850559	359
REC3584168	3584168	526-527-528	REC3809721	3809721	361	REC3850594	3850594	543-575
REC3584202	3580482	485	REC3809721	21140344	361	REC3850812	3850812	543-544
REC3584202	3584202	485	REC3812109	3812109	485	REC3850814	3850814	543
REC3584442	3584442	561	REC3812131	3812131	491			
REC3586461AL	3586461	557-559	REC3812199	3812199	485	REC3850852	3850852	534-537-540-545
REC3586461AL	3854130	578	REC3812240	3812240	440-450	REC3850942	3850942	548
REC3586461AL		558	REC3812357	3812357	534-573			355-543-544
REC3586494	875807	441	REC3817033	3817033	503-509	REC3852045	3852045	545-579
REC3586494	876689	441	REC3817328	3817328	374	REC3852056	3852056	355-548-571
REC3586494	3586494	441-448	REC3817687	3817687	439-450	REC3852106	966906	468
REC3586494		449-453	REC3817688	3817688	440-450			
REC3586496	21951342	441-443-448-449-455	REC3817861	3586722	502	REC3852106	966916	468
REC3586765	854346	398	REC3817861	3817861	502	REC3852106	3852106	468
REC3586765	3586765	398	REC3817861	3817861	509	REC3852106	3852336	468
REC3586765	3857265	398	REC3818912	3818912	435	REC3852106		349-468
REC3586765	3861027	398	REC3819905	852939	408	REC3852142	3852142	511
REC3586960	3586960	498	REC3819905	853502	408	REC3852165	3852165	403
REC3587071	3587071	396	REC3819905	856355	408	REC3852215	3852215	389
REC3587079	3587079	398	REC38201	3819905	408	REC3852272	3852272	537-543-544
REC3587079	3857079	398	REC38201	38201	515	REC3852279	3852279	543
REC3587079	3857489	398	REC38201	21114522	513-517	REC3852295	3852295	537-543-544-545
REC3587079	3857489	398	REC3825038	3825038	350-365	REC3852296	3852296	537-541-543
REC3587079	3858069	398	REC3827069	829161	366-368	REC3852315	3852315	548-549-551
REC3587079	3860879	398	REC3827069	829390	368	REC3852317	3852317	543
REC3587508	828023	433	REC3827069	3827069	366-368	REC3852350	3852350	548-571
REC3587508	3587508	433-435	REC3827069	3827069	366-368	REC3852352	3852352	578-583
REC3587597	3587597	347-348-423	REC3827069	21549542	350-351	REC3852454	3852454	543
REC3588434	3588434	497	REC3827273	3827273	469	REC3852455	3852455	472-476-516
REC3588745	3588745	557	REC3827444	874385	394	REC3852464	3852464	468
REC3588745	35888745	558-559	REC3827444	3827444	394	REC3852467	3852467	513-515
REC3588745AL	3588770	557-558-559	REC3829311	846354	444	REC3852476	3852476	516
REC3588746	3588746	557	REC3829311	3829311	444	REC3852535	3852535	578
REC3588746	3888814	558-559	REC3829313	845189	444			511-512-513-514-
REC3588746AL	3588748	557	REC3829313	866396	444	REC3852538	3852538	515-517-578
REC3588746AL	23164609	558-559	REC3829313	3829312	444			
REC3588916	874109	391	REC3829313	3829313	444	REC3852550	3852550	578
REC3588916	3588916	391	REC3831236	3831236	367	REC3852551	3852551	578-579
REC3589322	3589322	486-488	REC3831236	20821230	367	REC3852555	3852555	400-579
REC3589522	3589522	543	REC3831236	21640514	367	REC3852558	3852558	579
REC3589524	3589524	543	REC3831424	875849	422	REC3852560	3852560	355-543-578
REC3589875	3589875	559	REC3831424	876128	422	REC3852568	3852568	543
REC3589875AL	3589875	559	REC3831424	889425	422	REC3852602	3852602	516
REC3589876AL	3589876	559	REC3831424	3831424	422-424			513-515-516-
REC3593573	3593573	448	REC3831424	3831424	349-350	REC3852696	3852696	517-528
REC3593573	21730348	448	REC3831425	3831425	349-350-351-	REC3852830	3852830	513-515-516-517
REC3593573		446-449			352-424	REC3852865	3852865	537-548
REC3593654	3580064	445	REC3831426	824200	423	REC3852866	3852866	548-549-551-
REC3593654	3580900	445	REC3831426	875788	423			552-553-554
REC3593654	3580944	445	REC3831426	3831426	423-424	REC3852959	3852959	548-548-551
REC3593654	3593654	445	REC3831426		347-348-349-350	REC3852970	3852970	559
REC3593655	3580222	445	REC3837935	863437	444	REC3852970AL	3852970	559
REC3593655	3580223	445	REC3837935	876809	444	REC3853283	3853283	380-511
REC3593655	3580910	445	REC3837935	3825493	444	REC3853341	3853341	474-476
REC3593655	3580920	445	REC3837935	3837935	444	REC3853378	3853378	511
REC3593655	3580945	445	REC3838207	865295	447	REC3853423	3853423	403-543-578
REC3593655	3593655	445	REC3838207	3838207	447	REC3853430	3853430	511
REC3593659	3593656	448	REC3838207	3838207	457	REC3853431	3853431	511
REC3593659	22222936	448	REC3838288	3838288	446-456	REC3853434	3853434	516
REC3593659	3593659	441	REC3839110	3839110	350-351-424	REC3853536	3853536	468
		442-445-449-	REC3840335	3588378	360	REC3853628	3853628	511
		453-454	REC3840335	3840335	360	REC3853796	3853796	434-436
REC3593663	3593663	535-576	REC3840335	21624740	360	REC3853799	3853799	347-423
REC3593951	3593951	531	REC3840335		349-350	REC3853801	3853801	414
REC3593981	3593981	559-558-560	REC3840525	3589316	367	REC3853804	3853804	531
REC3593981AL	3593981	557-558-559-560	REC3840525	3840525	367	REC3853839	3853839	405
REC3594989	3594989	400	REC3840525		353	REC3853854	3853854	403-405
REC3594989	3854842	400	REC3840761	3840761	579	REC3853855	3853855	403-405
REC3594989	3861837	400	REC3840816	3840816	353-425	REC3853856	3853856	403-404
REC3594989	3863129	400	REC3840842	3840842	485	REC3853857	3853857	403-404
REC374MINORKIT		446-456	REC3840859	3840859	495	REC3853862	3853862	585
REC376MINORKIT		446-456	REC3840888	3803904	395	REC3853869	3853869	393-394-406
REC3801138	3809911	386	REC3840888	3840888	395	REC3853934	3853934	548-553
REC3801173	38879363	385	REC3841011	3841011	579	REC3853945	3853945	399
REC3801270	3847392	385	REC3841011	3841011	579	REC3853962	3853962	585
REC3801271	3847393	385	REC3841013	3841013	579	REC3853983	3853983	347-348-423
REC3801387	21163289	385	REC3841481	3841481	578	REC3854001	3854001	410-420
REC3801387	21354008	385	REC3841481	3841481	582	REC3854002	3854002	409
REC3801404	3801404	437	REC3841481	3854127	582	REC3854003	3854003	410-420
REC3801404	3801636	437	REC3841481	22197130	354	REC3854018	3854018	381-383
REC3801404	30751022	437	REC3841481		355	REC3854020	3854020	379-382-383
REC3801404	31293668	437	REC3841697	3841697	449	REC3854053	3854053	372
REC3801404		434	REC3841697	21951356	449	REC3854077	3854077	419
REC3802092	3581150	384			444-445-446-	REC3854105	3854105	379-382-383
REC3802105	3581755	384	REC3842853	3842853	449-454-454	REC3854130	3854130	557-559
REC3802125	3583006	384	REC3843100	3587927	513-515-523	REC3854130	3854130	558-578
REC3802149	3582768	385	REC3843100	3843100	390	REC3854138	3854138	406
REC3802150	3582769	385	REC3843100	3884352	390	REC3854159	3854159	390
REC3802151	3584053	386	REC3843136	3843136	390	REC3854161	3854161	409
REC3802152	3584138	386	REC3843751	3843751	387	REC3854190	841066	393
REC3807400	3807400	560	REC3843751	3857696	387	REC3854190	3854190	393
REC3807400AL	3807400	560	REC3843854	3843854	386	REC3854190		406
REC3808228	3808228	578-579	REC3847482	3847482	465	REC3854217	3854217	418
REC3808602	3808602	485	REC3847644	3847644	347-348-358-374	REC3854218	3854218	418
REC3808616	3808616	361-391	REC3848965	3801204	395	REC3854247	3854247	402
REC3808797	3808797	389	REC3848965	3848965	395	REC3854260	3854260	416-420
REC3808898	3594509	354-582	REC3848965	30782228	395	REC3854261	3854261	416-420
						REC3854286	3854286	441-442



REF	OEM	REF	OEM	REF	OEM
REC3854311	3854311	416-420	REC3861267	3861267	409
REC3854331	3854331	416-420	REC3861375	3861375	407
REC3854480	3854480	537-543°	REC3861376	3861376	406
REC3854548	3854548	417-420	REC3861575	3861575	398-399
REC3854549	3854549	420	REC3861634	3861634	561
REC3854549	3862014	417	REC3861634AL	3861634	561
REC3854595	3854595	548-549-551	REC3861636	3861636	560
REC3854601	3854601	551	REC3861636AL	3861636	560
REC3854624	3854624	549-551	REC3861985	3861985	409-421
REC3854625	3854625	549-551	REC3862105	3862105	537
REC3854905	3854905	388	REC3862228	3851218	358
REC3855017	3855017	381-383	REC3862228	3852413	358
		355-543-544	REC3862228	3862228	358
REC3855081	3855081	545-548-552	REC3862228		34-348
		553-554	REC3862387	3862387	539
		376	REC3862500	3862500	390-513-515-517
REC3855182	3855182	387	REC3862500	38622500	511
REC3855194	3855194	387	REC3862523	3862523	463
REC3855269	3855269	523	REC3862523	3862526	436
REC3855269	3855269	516-523	REC3862612	3862612	398
REC3855271	3855271	523	REC3862852	3862852	463
REC3855271	3855271	523	REC3862867	3862867	539-544
REC3855271	3855271	523	REC3863007	3849411	400
REC3855271	3855271	516-523	REC3863007	3849413	400
REC3855275	3855275	548-574	REC3863007	3855535	400
REC3855276	981650	372	REC3863007	3863007	400
REC3855276	3855276	372	REC3863080	3863080	539-576
REC3855411	3855411	560	REC3863080	+3863081	
REC3855411	3855411	548-549-551	REC3863082	3863082	539
		557-558-559	REC3863083	3863083	539-576
REC3855650	853846	400	REC3863084	3863084	539
REC3855650	876317	400	REC3863085	3863085	539-544
REC3855650	3855650	400	REC3863090	3858303	576
REC3856002	3856002	574	REC3863090	3863090	548-553-576
REC3856002	3856002	548-549-551	REC3863130	3863130	388-421
REC3856008	897816	584	REC3863191	3863191	513-515-516-517
REC3856008	3852325	584	REC3863193AL	3863193	560
REC3856008	3856008	540-541-543	REC3863193AL	3863193	548-549-551-
		545-584			557-558-559
REC3856844	3856839	400	REC3863450	3863450	511-513-515-516-
REC3856844	3856844	400			517-528
REC3856961	3856961	423	REC3883777	3883777	579
REC3857140	3857140	556	REC3883845	3589554	490
REC3857176	3856176	543	REC3883845	3883845	490
REC3857176	3857176	540-541-543-545	REC3884548	3884548	491
REC3857521	3857521	403	REC3884858	3803577	396
REC3857522	3857522	403	REC3884858	3803940	396
REC3857523	3857523	403-404	REC3884858	3884858	396
REC3857524	3857524	403-405	REC3884950	3862613	398
REC3857533	3857533	407	REC3884950	3862665	398
REC3857650	3857650	374	REC3884950	3884950	398
REC3857675	3857675	548	REC3884974	3860871	530
REC3857813	3857813	397	REC3884974	3884974	530
REC3857835	3857835	468	REC3885317	3860764	393
REC3857954	3857954	439-440-450	REC3886431	3886431	485
REC3858077	3858077	399	REC3887328	3842442	389
REC3858212	3858212	400	REC3887328	3887328	389
REC3858212	21652399	400	REC3887373	3887373	530
REC3858261	3858261	375	REC3887761	3887761	449
REC3858261	3857986	375	REC3887761	21951358	449
REC3858261	3858261	375	REC3888177		446-449
REC3858399	3858399	561	REC3888491		347-466
REC3858399	3858399	557-559	REC3888555	3888555	561
REC3858399	3858399	557	REC3888555	3888555	578-579
REC3858399AL		557-559-561	REC3888814	3589875	557
REC3858437	3858437	585	REC3888814	3888814	552-553-554-
REC3858457	852206	570	REC3888817	3841427	557-558-559
REC3858457	872891	570	REC3888817	3888817	557
REC3858457	3856070	570	REC3888817		557-579
REC3858457	3858457	547-570	REC3888916	3888916	559
REC3858458	872872	570	REC3888916	876392	354-579-582
REC3858458	3856069	570	REC3888917	3888917	575
REC3858458	3857307	570	REC3888978	3889782	544-575
REC3858458	3858458	547-570	REC3889784	3889784	544
REC3858462	966700	468	REC3889786	3889786	552-553-554
REC3858462	3858462	468	REC3889788	3889788	579
REC3858462		349	REC3889964	3889964	513-515-517-523
REC3858714	3858714	375	REC3889964	3889965	523
REC3858941	3858941	376	REC391-5090	835304	415
REC3858984	3858984	410	REC391-5090Q1		415
REC3859050	3859050	537-572	REC392-6324Q1		414
REC3859054		393-394-406	REC392-6325Q1		414
REC3859078	3859078	409	REC392-9086T	841926	414
REC3859082	3859082	388	REC392-9766	3853815	414
REC3859082	3861323	388	REC393831	3850813	543
REC3860079	3860079	464-466	REC393831		543-578
REC3860082	3860798	397	REC398042	3850984	548-571
REC3860082	3862612	397	REC4-17ALU		588
REC3860086		466	REC4-19ALU		588
REC3860092	3860092	347-468	REC40005192	40005192	569
REC3860171	3860171	397	REC40005334	40005334	419-421
REC3860171	83857561	397	REC40005775	40005775	498
REC3860183	3860183	545	REC40155	3852224	358
REC3860232	3860232	541-545	REC40970	3817092	395
REC3860384	3858139	583	REC40990	22027280	395
REC3860384	3860384	354-583	REC41100098	41100098	560
REC3860703	856513	440	REC41100098AL	41100098	560
REC3860703	3860703	440	REC41100276		559
REC3860703		441	REC41100276AL		559
REC3860769	3854809	397	REC41400		389
REC3860769	3860769	397	REC416033	416033	422-426
REC3860808	3860808	556	REC416033	418361	422
REC3860842	3860842	543	REC416033	1317466	422
REC416033	7416033	426	REC418411	418411	443-459
REC418411	418411	459	REC418412	418412	459
REC418445	418445	459-527	REC418445	418445	459-527
REC418737	418737	518-520	REC418737	418737	518-520
REC419310	419310	480	REC419310	419310	480
REC419310	419763	480	REC419643	419643	509-518-520
REC419643	419643	482	REC419678	419678	482
REC419734	419734	518	REC419734	419734	518
REC419735	419735	518	REC419735	419735	518
REC421306	421306	437	REC421306	421306	437
REC425784	425784	539	REC425784	425784	539
REC430017	430017	435	REC430017	430017	435
REC430018	430018	459	REC430018	430018	459
REC430020	430020	459	REC430020	430020	459
REC430039	430039	482	REC430039	430039	482
REC430172	430172	458	REC430172	430172	458
REC430272	430272	459-461	REC430272	430272	459-461
REC46-8M0113733	3854017	433	REC46-8M0113733	3854017	433
REC46-8M0113733	3858340	433-435	REC46-8M0113733	3858340	433-435
REC46-8M0113733		434	REC46-8M0113734		434
REC46-8M0113734	3853850	434-435-436	REC46-8M0113734	3853850	434-435-436
REC46-8M0113735	856609	433	REC46-8M0113735	856609	433
REC46-8M0113735	3854118	433	REC46-8M0113735	3854118	433
REC46-8M0113735	3855991	433-436	REC46-8M0113735	3855991	433-436
REC46-8M0113735		434-435	REC46-8M0113735		434-435
REC46-8M0113736	3861341	434-436	REC46-8M0113736	3861341	434-436
REC46335	3853404	511-513-515-516	REC46335	3853404	511-513-515-516
REC463377	463377	464-467	REC463377	463377	464-467
REC463395	463395	518	REC463395	463395	518
REC463526	463526	518	REC463526	463526	518
REC463739	463739	518-520	REC463739	463739	518-520
REC463902	463902	508	REC463902	463902	508
REC463902	955103	508	REC463902	955103	508
REC463903	463903	508	REC463903	463903	508
REC463905	463905	508	REC463905	463905	508
REC466382	466382	519	REC466382	466382	519
REC466383	466383	519	REC466383	466383	519
REC466384	466384	519	REC466384	466384	519
REC468305	468305	519	REC468305	468305	519
REC469482	469482	506	REC469482	469482	506
REC469483	422581	462	REC469483	422581	462
REC469846	469783	462	REC469846	469783	462
REC469846	424342	462	REC469846	424342	462
REC471034	469846	462	REC471034	469846	462
REC471034	471034	350-351-367	REC471034	471034	350-351-367
REC471956	471956	492	REC471956	471956	492
REC477024	192211	508	REC477024	192211	508
REC477024	463903	508	REC477024	463903	508
REC477024	477024	508	REC477024	477024	508
REC477026	192426	508	REC477026	192426	508
REC477026	477026	508	REC477026	477026	508

REF	OEM		REF	OEM		REF	OEM	
REC807964A1	807964A1	418-420	REC840902	840902	492-527	REC856472	856472	381-383
REC813967	813967	577-581	REC840902	3875050	492-524	REC857618	857618	512-514
REC814301	814301	569	REC840944	840944	493	REC857621	419628	480
REC814332	814332	555-570	REC840962	840962	386	REC857621	857621	480
REC814356	814356	555-569	REC841161	841161	372	REC857621	875543	480
REC814388	814388	555-568	REC841177	841177	407	REC857621	876783	480
REC814390	814390	555-569	REC841243	841243	415	REC858464	858464	576
REC814396	814396	555-570	REC841262	241710	413	REC858467	858467	452-444
REC814419	814419	555-569	REC841262	841262	413	REC858488	858488	349-350-365
REC8149182	8149182	353-425	REC841262	841262	413	REC858570	858570	431
REC817377	817377	418-420	REC841263	841263	413	REC858979	858979	430
REC818184	818184	505	REC841294	841293	381-383	REC858986	842744	461
REC819959	819959	452	REC841693	841693	451	REC858986	858986	461
REC823426A1	855889	381-383	REC841750	841750	346-359	REC859002	859002	527
REC823661		559-561	REC841769	873770	396	REC859010	845301	433
REC823661AL		559-561	REC841893	824991	585	REC859010	859010	433
REC824326002		471-518	REC841893	831106	585	REC859011	859011	527
REC824677	824677	380	REC841893	841893	585	REC859015	803374	492
REC826239	826239	450	REC841994	841994	381-383	REC859015	859015	492
REC826493	826493	372	REC842080	842080	519	REC859015		525-527
REC827151	827151	391	REC842280	842280	365	REC859027	859027	435-437
REC827247	827247	458	REC842280		350-351-352	REC859027	1542229	435
REC827250	827250	452	REC842913	842913	524-527	REC859034	859034	431
REC82744	82744	462-512	REC843323	843323	584	REC859034	1542289	431
REC82745	82745	462	REC845294	845294	383	REC859038	842990	494
REC82745	997641	510	REC845354	845354	457	REC859038	859038	494
REC828140	828140	560	REC846037	846037	384	REC859039	859039	494
REC829207	829207	349-469	REC847573	847573	430	REC859039	1542219	494
REC829433	829433	444-452	REC847605	847605	391	REC859042	840572	490
REC829487	829487	495	REC847741	847741	350-351-353-367	REC859042	859042	490
REC829587	829587	389	REC850834	850834	399	REC859043	840440	490
REC829592	829592	463	REC850888	850888	546-560-570-588	REC859043	859043	490
REC829620	892260	518	REC850889	850889	546-570-588	REC859044	840461	490
REC829714	829714	443-459	REC85104134	3183241	377	REC859044	859044	490
REC829913	829913	349-352-360	REC85104134	85104134	377	REC859045	845291	428
REC831009	806256	452	REC85104134	85115324	377	REC859045	859045	428
REC831009	831009	452	REC85104134	85124676	377	REC859047	845585	429
REC831009		439	REC85122800	85122800	591	REC859047	859047	429
REC831239	831239	383	REC851407	851407	537-547-549-551-552-554-576	REC859061	842669	428
REC831617	831617	459	REC851430	851430	402-577	REC859061	859061	428
REC831622	831622	439-459	REC852018	852018	560	REC859065	842645	431
REC831986	831986	465	REC852018AL	852018	560	REC859065	859065	431
REC832191	832191	546	REC852019	852019	559	REC859086	842586	433
REC832534	832534	555-570	REC852019AL	852019	559	REC859086	859086	433
REC832570	832570	540	REC852212	852212	537-547-549-551-552-554	REC859093	840405	485
REC832598	832598	557-558-559	REC852565	852565	405	REC859093	859093	485
REC832598AL		557-558-559	REC852705	852705	541-545	REC859094	840328	484
REC832669	832669	540-541	REC852835	852835	557	REC859094	859094	484
REC832675	832675	540-541-545	REC852835	852835	557-559-577	REC859107	859107	492-525
REC832820	832820	555-568	REC852835	852835	557	REC859112		525-527
REC832831	832831	583	REC852835AL	3588770	557-558-559	REC859120	802399	490
REC832846	832846	569	REC852839	852839	404	REC859120	859120	490
REC832846	851452	555	REC852868	852868	577-581	REC859131	844084	433
REC832846	854031	555	REC852928	852928	398	REC859131	859131	433
REC832934	832934	559	REC852928	3586765	398	REC859134	838127	484
REC832934AL	832934	559	REC853048	853048	555-577	REC859134	859134	484
REC833188	833188	518	REC853175	853175	555	REC859135	859135	485
REC833274	833274	484	REC853484	853484	541	REC859135	3875376	485
REC833878	833878	451	REC853542	853542	540	REC859137	833453	484
REC833913	833913	560	REC853678T	3857487	387	REC859137	859137	484
REC833915	833915	560	REC853759	853759	402-577	REC859140	819720	493
REC833994	833994	452	REC853760	853760	402-577	REC859140	859140	493
REC833996	833996	458	REC853808	853808	537-549-554-576	REC859145	833598	492
REC834337	834337	366-534	REC853808	853808	576	REC859145	859145	492
REC834337	897321	366	REC853808	853807	551-552	REC859145	897322	492
REC834337	22057107	366	REC853808	+853808		REC859150	859150	486
REC834337		349-352-	REC853868	853868	537-540-541-543-545-576	REC859150	1544109	486-509
REC834751	834751	512-514-528	REC853998A1		376	REC859151	833070	484
REC834871	834871	510	REC854031	854031	569	REC859151	859151	484
REC834975	834975	414	REC854040	854040	546-548	REC859152	829214	486
REC835581	835581	426	REC854045	854045	546-570-588	REC859152	829531	486
REC835702	835702	414	REC854047	854047	546-570-588	REC859152	829531	486
REC838066	838066	490	REC854525	3858071	398	REC859152	859152	486
REC838637	833637	509-519	REC854541	854541	546	REC859155	859155	486
REC838638	838638	509-519	REC854935	854935	512-514	REC859155	859155	486
REC838652	838652	491-509	REC855105	855105	559	REC859155		509
REC838653	838653	491-509	REC855105AL	855105	559	REC859171	21501189	507-509-519
REC838654	838654	491	REC855297	841600	372	REC859194	859194	493
REC838766	838766	462	REC855297	855297	372	REC859194	3875382	493
REC838775		509	REC855314		406	REC859196	845353	431
REC838807	838807	422-425	REC855389	831778	585	REC859196	859196	431
REC838929		349-350-352-	REC855389	841895	585	REC859428	859428	373
REC838929AL		353-561-559	REC855389	855389	585	REC859494	859494	376
REC839195	839195	559-561	REC855389	855389	406	REC859618	859618	406
REC839253	839253	402-555	REC855405	855405	428-429	REC859642	859642	502
REC839253	853670	573	REC855506	855506	464-467	REC859647	859647	486
REC839423	839423	546-570	REC855507	855507	465	REC859791	859791	504
REC839534	839534	546-570	REC855513	855513	483	REC859807	859807	505
REC84-817376T01	3854084	420	REC855582	825582	429-461	REC859835		525-526-527
REC84-819514T26		399	REC855617	855617	585	REC859836	859836	526-527
REC840074	840074	391	REC855686	855686	346-347-356-358	REC859836	3587410	526
REC840115	840115	490	REC855694	835550	585	REC859945	859945	504
REC840115	3875384	490	REC855694	855694	585	REC859949	859949	505
REC840384	833997	451	REC855694	855694	585	REC860388	860388	350-469
REC840384	840384	451	REC855728	855728	451	REC860920	860920	430
REC840385	840385	452	REC855967	855967	483-510	REC860971	3582851	498
REC840442	840442	492	REC856004	856004	426	REC861019	861019	464
REC840569	840569	484	REC856028	856028	510	REC861103	861103	376
REC840648	818035	495	REC856036	856036	512	REC861250	860684	495
REC840648	840648	495	REC856042	856042	512	REC861250	861250	495
REC840785	803723	451	REC856044	824633	483	REC861251	1544124	495
REC840785	804693	451	REC856044	856044	483-510	REC861251	859032	495
REC840785	840785	451				REC861251	860685	495
REC840785	840785	451				REC861251	861251	495



REF	OEM		REF	OEM		REF	OEM	
REC861251	1542247	495	REC875439	875439	497	REC876301		480
REC861255	861255	377-509	REC875498	875498	502	REC876302	876022	481
REC861260	861260	383	REC875499	875499	502	REC876302	876302	481
REC861263	861263	430	REC875512	804186	583	REC876302		480
REC861407	861407	385	REC875512	875512	583	REC876303	876071	481
REC861414	861414	385-493-525-527	REC875512	875827	583	REC876303	876303	481
REC861431	861431	584	REC875541	875320	502	REC876303		480
REC861473	861473	367	REC875541	875541	502	REC876304	876072	484
REC861473	861826	367	REC875541	875655	502	REC876304	876304	484
REC861473	3808605	367	REC875550	875550	501	REC876305	424299	423
REC861473		352-353	REC875551	875551	501	REC876305	835177	423
REC861476	859746	367	REC875574	875574	455	REC876305	875794	423
REC861476	861476	367	REC875574	876081	455	REC876305	876305	423
REC861476		349	REC875575	875575		REC876305		346-347
REC861477	861477	360		439-441-442-		REC876306		483
REC861477	3580096	360	REC875579	875579	501	REC876306	875403	483
REC861477	3841080	360	REC875580	875580	346-349-423	REC876306	876306	483
REC861477	21190113	360	REC875584	875584	455	REC876307	876307	484-487
REC861477		352-353	REC875676	875676	502	REC876308	876308	484-487
REC861563	861563	465-467	REC875697	875697	449	REC876310	876310	485-487
REC861564	861564	349-350-467-469	REC875697	875814	449	REC876314	875509	496
REC861603	859726	495	REC875697	875814	449	REC876314	876314	496
REC861603	861603	495	REC875698	21951364	449	REC876337	875402	480
REC861688	861688	377-509	REC875698	875698	454	REC876337	875533	480
REC861698	861698	519-509	REC875698	21951420	454	REC876337	875570	481
REC861699	861699	519-509	REC875698	21951420	454	REC876337	876335	480
REC861700	861700	507-519	REC875722	275052	502	REC876337	876337	480
REC861700	877072	507-519	REC875722	875652	502	REC876337	876359	481
REC861700	877073	507-519	REC875722	875707	502	REC876337		480
REC861700		509	REC875722	875722	502	REC876341	875561	487
REC861725	861725	376	REC875722	875722	509	REC876341	876341	487
REC861822	861822	495	REC875741	876266		REC876341		484
REC861823	861823	498	REC875741	+876267	572	REC876342	875400	483
REC861860	861860	507-518	REC875756	875756	455	REC876342	876342	483
REC861865	861865	484	REC875757	875757	496	REC876349	875634	497
REC861907	861907	524-526-527	REC875769	875769	455	REC876349	876349	497
REC8631533	8631533	388	REC875769	21951410	455	REC876349		495
REC8631652	861700	519	REC875783	875783	349-424	REC876356	876356	480
REC8631652	877072	519	REC875785	875785	349-351-352-424	REC876358	875569	481
REC8631652	877073	519	REC875791	831040	423	REC876358	876358	481
REC8631652	8631652	519	REC875791	875791	423	REC876358		480
REC863169	863169	391	REC875791		346	REC876361		495
REC863946	863946	392	REC875796	875796	349-423-424	REC876376	875553	487
REC8642665	8642665	491	REC875805	875805	560	REC876376	876376	484-487
REC864297T01	3858979	388	REC875805AL	875805	560	REC876377	875500	487
REC864315	863750	361	REC875809	875809	560	REC876377	875502	487
REC864315	864315	361	REC875809AL	875809	560	REC876377	875504	487
REC8653103	8653103	391	REC875810	875810	560	REC876377	876374	487
REC865428	865428	384	REC875810AL	875810	560	REC876377	876375	487
REC8658726	8658726	388	REC875812	875812	560	REC876377	876377	487
REC866653	866653	350-351-469	REC875812AL	875812	560	REC876377		484
REC866835	866835	389	REC875815	875815	560	REC876378	875501	495
REC866836	866836	389	REC875815AL	875815	560	REC876378	876378	495
REC8676498	3803645	396	REC875821	875821	546-547-557-560	REC876379	875508	487
REC8676498	8676498	396			546-547-557-560	REC876379	876379	487
REC8692305	8692305	347-348-353-359-368	REC875821AL	875821	546-547-557-560	REC876379		485
REC8692438	8692438	491	REC875822	875822	558-559-560	REC876380	875572	487
REC870690	870690	413	REC875822	22303438	354-583	REC876380	876380	487
REC872066	872066	390	REC876037	876037	583	REC876380		484
REC872082	872082	546-570	REC876037	876037	407	REC876381	875562	496
REC872096	872096	555-556-568	REC876054	876054	496	REC876381	876381	496
REC872096	876507	355-568	REC876069	849270	369	REC876382	875715	496
REC872139	872139	559	REC876069	876069	369	REC876382	876382	496
REC872139AL	872139	559	REC876069	876070	369	REC876383	875573	496
REC872334	872334	577	REC876069	3830004	369	REC876383	876383	496
REC872338	872338	577	REC876069		349-350-351-352	REC876384	875554	496
REC872362	872362	402	REC876073	876073	575	REC876384	876384	496
REC872722	872722	577	REC876080	82812	423	REC876388	875505	495
REC872752	872752	577	REC876080	824912	423	REC876388	876388	495
REC872752	872752	555-556-569	REC876080	875781	423	REC876389	875503	496
REC872753	872753	556	REC876080	875790	423	REC876389	876389	496
REC872756	872756	556	REC876080	876080	423-424	REC876391	875720	535-571
REC872793	872793	558-559	REC876080	876097	424	REC876391	876391	535-571
REC872793AL	872793	558-559	REC876080	876797	423	REC876391		535
REC872812	872812	402-577	REC876080		346-349-425	REC876393	875588	484
REC872845	872845	577	REC876099	838660	502	REC876393	876393	484
REC872986	872986	556	REC876099	867975	502	REC876393	876433	484
REC873066	873066	391	REC876099	876099	502	REC876416	875438	489
REC873228	873228	404	REC876099		509	REC876416	876416	489
REC873229	873229	404	REC876114	876114	502	REC876417	875388	488
REC873395	873395	558-559	REC876144	876144	493	REC876417	875567	488
REC873395AL	873395	558-559	REC876161	876161	502	REC876417	876417	488
REC873413	873413	560	REC876185	463505	366	REC876417		486
REC873534	873534	556	REC876185	863344	366	REC876427	876032	497
REC873549	859593	395	REC876185	876185	366	REC876427	876427	497
REC873549	872241	395	REC876185		349-350-351	REC876427		495
REC874502	874502	396	REC876266	876266	540-541-574	REC876431	876430	487
REC874502	3587216	396	REC876267	876267	547-573	REC876431	876431	487
REC874502	3803650	396	REC876268	876268	573	REC876431		485
REC874502	3803846	396	REC876278	826341	355-555-568	REC876448	876023	484
REC874502	3803903	396	REC876279	853223	555	REC876448	876448	484
REC874502	3803911	396	REC876279	853223	568	REC876511	876511	506-509
REC874502	3819662	396	REC876279	876279	568	REC876515	876515	505-509
REC874502	3840181	396	REC876279		355	REC876516	876516	505-509
REC875303	875303	505	REC876286AL	876286	535-559-560	REC876519	876519	505-509
REC875306	875306	504	REC876294	875826	582-583	REC876520	876520	505-509
REC875307	875307	504	REC876294	876294	354-540-541-	REC876548	876548	502
REC875331	875331	505			582-583	REC876548	876611	502
REC875334	875334	504	REC876294	897889	582-583	REC876554	876554	349-361
REC875383	875383	455	REC876294		355	REC876588	876588	575
REC875387	875387	497	REC876300	875587	481	REC876614	876614	405
REC875387	875421	497	REC876300	876300	481	REC876631	875848	582
REC875407	875407	381-383	REC876300	875678	481	REC876631	876631	354
			REC876301	876301	481	REC876631	876631	540
						REC876631	876631	577

REF	OEM		REF	OEM		REF	OEM	
REC876631	876631	582	REC93568		358	REC967344	967344	445-537-541-
REC876631		355	REC940136	940136	512-514			543-544-545
REC876631	876631	556	REC940191	940191	556	REC967707	967707	556
REC876633	876633	354-540-582	REC940191	940191	539-555	REC967944	967944	493
REC876638	876638	559	REC941807	941807	541	REC968048	968048	395
REC876638AL	876638	559	REC941816	941816	540	REC968555	968555	459
REC876655	876655	497	REC941820	941820	555	REC968927	968927	422-460
REC876774	876106	498	REC941907	941907	535	REC968955	968955	508
REC876774	876362	498	REC941907	941907	512-514	REC968955	1542263	508
REC876774	876531	498	REC942336	942336	512-514	REC968955	60112158	510
REC876774	876774	498	REC942547	942547	512-514	REC968955		509
REC876774		495	REC942615	942615	540	REC968971		443-444
REC876775	3586758	503-509	REC942791	942791	537	REC969011	969011	378
REC876793	876560	438	REC944988	944988	378	REC969011	13969011	378
REC876793	876793	438	REC945624	945624	539	REC969011	20459972	378
REC876794	876544	438	REC946056	946056	579	REC969011	21108673	378
REC876794	876794	438	REC946242	946242	581	REC969071	969071	546-547
REC877349	877349	349-424	REC946438	946438	537-549-551	REC969073	969073	546
REC877355	877355	352-424	REC947620	947620	378	REC969198	967643	492
REC877372	21389074	354-535-572	REC947620	947620	378	REC969198	969198	492
REC877373	875759	455	REC947620	6601761	378	REC969331	967763	458
REC877373	876088	455	REC947620	20459900	378	REC969331	969331	458
REC877373	876529	455	REC947622	947622	378	REC969415	969415	433-527
REC877373	877373	455	REC947622	993436	378	REC973593	973593	545
REC877419	877419	497	REC947622	13947622	378	REC973639	973639	450
REC879194401	21124846	434-435-436	REC947622	20450903	378	REC975309	975309	433
REC88-79023T10		408	REC947622	20549894	378	REC975672	925091	429
REC883166A2	3861570	399	REC947627	947627	378	REC975672	975672	429
REC8845		375	REC947627	13947627	378	REC975672		441-443
REC885176	3858969	376	REC947893	947893	463	REC976018	955988	378
REC885195	885195	590	REC947904	947904	577	REC976018	976018	378-534
REC8865		374	REC948610	925067	429	REC976018	13955988	378
REC886MINORKIT		447-456	REC948610	948255	429	REC976039	859055	506
REC888596	888596	525-527	REC948610	948610	429-461	REC976039	976039	506
REC889419	889419	362	REC949187	949187	492	REC976039	980936	506
REC889422	889422	362	REC949656	949656	534-537-544	REC976039	1542385	506
REC889455	889455	539	REC949657	925060	462	REC976041	976041	433
REC889486	889486	491	REC949657	949657	462	REC976051	976051	428
REC889672	889672	535	REC949657	13949657	462	REC976106	190187	433
REC889970	889970	377	REC949658	12276	433	REC976106	976106	433
REC890MINORKIT		446-456	REC949658	949658	433	REC976483	976483	350-469
REC892617	3808516	388	REC949659	12288	462	REC977542	977542	349-350-469
REC897367	897367	546-570	REC949659	925065	462	REC978217		467
REC897426	897426	546-576	REC949659	949659	462	REC978482	978482	352-469
REC897682	897682	355-540-541	REC949659	14012288	462	REC978750	978750	346-347-467-468
REC897726	897726	581	REC949721	12279	431-433	REC979254	979254	556-569
REC898253013	3858977	417-418-421	REC949721	925062	431-433	REC981183	981183	378
REC898253013	898253013	417-418	REC949721	949721	431-433	REC982209	508932	415
REC89825302	508935	415	REC949721	13949721	431-433	REC982230	841054	358
REC898253T22	3858975	418-421	REC949721	14012279	431-433	REC982230	855952	358
REC898253T23	3859019	417-421	REC949722	949722	433	REC982230	877765	358
REC8M0068784	3857532	389	REC949722	13949722	433	REC982230		346
REC8M0073435	3854858	372	REC949841	949841	494	REC982570		467
REC8M0077616	3854512	388	REC949974	94997	433	REC984068	984068	541-545
REC8M0087834	3858987	387	REC951924	951924	540-541-543	REC984222	984222	539
REC8M0087834	3859020	387	REC951936	951936	539-544	REC984223	984223	539
REC8M0125617	3855184	387	REC952980	952980	528	REC984224	984224	539
REC8M6001217	835308	415	REC955893	955893	549-551-554	REC984225	984225	539
REC8M6001219	835705	414	REC955974	955974	355-535-540-	REC984491	3854019	358
REC8M6001249	835704	414			541-546-547-573	REC985052		382-383
REC9-29307		413	REC955976	12262	459-492	REC990899	990899	569
REC906633	906633	575	REC955976	926033	459-492	REC994130	994130	508
REC908765	826479	380	REC955976	955976	459-492	REC994130	1306341	508
REC908765	856033	380	REC955976	6647311	459-492	REC997368	997368	544
REC91-25034		530	REC955976	14012262	459-492	REC997368	3852565	537
REC91-888863	885163	420	REC955981	955981	355-509-537-	REC997368	3852565	543
REC9139282	462623	480			549-551	REC997641	947894	463
REC9139282	9139282	480	REC955989	955989	355-534-540-541	REC997641	949918	463
REC9139284	430107	480	REC956000	956000	540-541-545-573	RECC2		589
REC9139284	461056	480	REC956590	956590	541	RECC3		589
REC9139284	461618	480	REC957170	957170	378	RECC5		589
REC9139284	913928	480	REC957171	957171	378	RECC6		589
REC9139284	3855409	480	REC957181	18840	378	RECEFP-KT		375
REC914462	914462	437-581	REC957181	957181	378	RECGS00530		364-365
REC914515	914515	452	REC957181	1218022	378	RECGS01030		364-365
REC914533	914533	581	REC957181		391	RECGS01830		365
REC925050	925050	402-577	REC957184	957184	378	RECHOL17-6		380
REC925052	905052	541	REC957184	6613687	378	RECKIT280DP		355
REC925054	925054	535	REC958860	941870	581	RECKIT290DP		355
REC925055	925055	461	REC958860	958860	581	RECKIT290SP		355
REC925064	925064	577	REC959794	959794	514	RECKITDP		402
REC925066	12291	461	REC959796	959796	512	RECKITDPC		402
REC925066	213244	461	REC960166	960166	457	RECKITDPC-D-E		355
REC925066	925066	461	REC964106	964106	428	RECKITDPH		355
REC925066	14012291	461	REC966207	966207	402-577	RECKITDPR		355
REC925066	14213244	461	REC966382	966382	346-467	RECKITDPS-SX		355
REC925068	23405	461-462	REC966383	966383	349-468	RECKITSPE		355
REC925068	925068	461-462	REC966387	966387	469	RECKITSXA		355
REC925068	11991571	461-462	REC966694	966694	346-467	RECKITV280AL		560
REC925068	14023405	461-462	REC966694	966694	349-468	RECKITV280AL		561
			REC966707	966707	349-468	RECKITV280DPAL		561
			REC966891	966891	346-467	RECKITV280DPAL		561
			REC966900	966900	352-469	RECKITV280DPAL		355-560
			REC966903	966903	352-469	RECKITV280DPM		560
			REC966906	966906	349-350-352-	RECKITV280DPM		561
					468-469	RECKITV280DPM		560
			REC966914	966914	468	RECKITV280DPZM		560
			REC966931	966931	349-468	RECKITV280M		560
			REC966933	966933	349-468	RECKITV280M		561
			REC966942	966942	349-468	RECKITV280ZN		560
			REC966978	966978	349-350-469	RECKITV280ZN		561
			REC966990	966698	468	RECKITV290AL		561
			REC966990	966990	468	RECKITV290AL		355-560
			REC966990	966990	349	RECKITV290DPAL		355-560
			REC967111	967111	346-347-467-468	RECKITV290DPM		560



REF	OEM	REF	OEM	REF	OEM		
RECKITV290DPZN	560	RM21632901	22030852	368	RM3852289	3852289	435-463
RECKITV290M	560	RM21745117	21745117	529	RM3852390	3852390	537-540-541-543-544-545
RECKITV290M	561	RM21745117	22256625	529			
RECKITV290ZN	560	RM21745117	22452003	529	RM3852418	3852418	543
RECKITV290ZN	561	RM22197130	22197130	354	RM3852504	3852504	468
RECKITVDPHAL	561	RM22197130	22197130	579	RM3852516	3852516	543
RECKITVDPHAL	355-560	RM22197130	22197130	582	RM3852573	3852573	403
RECKITVDPHM	560	RM22197130		355	RM3852607	3852607	347-468
RECKITVDPHM	561	RM23538670	23538670	368	RM3852958	3852958	403
RECKITVDPHZN	560	RM23954708	22984479	361	RM3853424	3853424	403-543
RECKITVDPHZN	561	RM23954708	23954708	361	RM3853608	3853608	528
RECKITVXSAAAL	561	RM23954708		353	RM3853825	3853825	404
RECKITVXSAAAL	355-560	RM243801	243801	412	RM3854643	3854643	347-468
RECKITVXSAL	561	RM30731740	30731740	503	RM3854874	3854874	513-523
RECKITVXSAL	355-560	RM30750678	30750678	503	RM3856365	21258485	589
RECKITVXSAM	560	RM31261191	8683212	360	RM3856366	3856366	589
RECKITVXSAM	561	RM31261191	31261191	360	RM3856366	21258486	589
RECKITVXSAM	560	RM31261191		353	RM3856367	3856367	589
RECKITVXSAM	561	RM3517857	418432	359-366	RM3856367	21258487	589
RECKITVXSAM	560	RM3517857	430143	359-366	RM3856502	3856502	537-540-541-543-545
RECKITVXSAM	561	RM3517857	1266286	359-366			
RECKITVXSAM	560	RM3517857	3517857	359-366	RM3857148	3857148	541
RECKITVXSAM	561	RM3580303	3580303	518	RM3857391	3857391	435-463
RECKITVXSAM	356	RM3580304	3580304	518-519	RM3857431	3857431	403
RECOBBRACKET	431	RM3580337	3580337	503	RM3857470	3857470	403
RECOILCOOLER	393	RM3580338	3580338	503	RM3857471	3857471	401
RECPG260	406	RM3580365	3580365	352-424	RM3857588	3857588	403
RECRA122002	371	RM3580546	3580546	503	RM3857588	3857588	403
RECRK21069	364	RM3580547	3580547	503	RM3858051	3858051	548
RECSWK-2000/10	364	RM3581114	3581114	528	RM3858128	3812269	529
RECSWK-2000/5	451	RM3581115	3581115	528	RM3858128	3860726	529
RECV11010	11010	RM35811621	35811621	349-469	RM3858128	3860883	529
RECV11010	861812	RM3581460	3581460	366	RM3858128	3862210	529
RECV11010	3578536	RM3581621	861474	366	RM3858128	3862513	529
RECV11010	3884972	RM3581621	861475	366	RM3858128	21910902	529
RECV11010	6600756	RM3581621	3581621	366	RM3858631	3858631	578
RECV11013	11013	RM3581621	21549544	366	RM3858873	3850794	522
RECV11013	7011013	RM3581724	860786	392	RM3858873	3850796	522
RM1542287	1542287	RM3581724	3581062	392	RM3858873	3853915	522
		RM3581724	3581724	392	RM3858873	3855281	522
RM184691	184691	RM3582357		365	RM3858873	3858873	513
		RM3582424		467	RM3858873	3858873	515
RM20856959	20856959	RM3582732	3582732	368	RM3858873	3858873	516
RM20867177	20867177	RM3582732	22030848	368	RM3858873	3858873	517
RM20867178	20867178	RM3583443	3583443	361	RM3858873	3858873	522
RM20867661	20867661	RM3583443	21718912	361	RM3858873	3858873	578
RM20867751	20867751	RM3583693	3583693	503	RM3858873	3858873	468
RM21132385		RM3584086	3584086	353-469	RM3860087	3860087	347-468
RM21132674	21132674	RM3586324		466	RM3860093	3860093	468
RM21132989	3884512	RM3586325		466	RM3860230	3860230	540-541-545
RM21132989	21132989	RM3586326		347-466	RM3860252	3860252	548-549-551
RM21132990	21132990	RM3586326		466	RM3860842	3860842	544
RM21139810	21139810	RM3586871	3586871	504	RM3860842	3860842	537-543
RM21186281	3580478	RM3586873	3586873	504	RM3860881	872837	401
RM21186282	21307714	RM3586877	3586877	504	RM3860881	3860881	401
RM21212798	3812522	RM3586883	3885323	506	RM3860881		401-402
RM21212798	21212798	RM3587072	3587072	396	RM3861459	3852362	521
RM21212801	21131568	RM3587651	3587651	511-513-515-516-	RM3861459	3861459	517-521
RM21212801	21212801			517-578	RM3861500		466
RM21214595	3812696	RM3588435	3588435	385-386-493	RM3861501		466
RM21214595	3861417	RM3588437	3588437	425	RM3862228	3851218	358
RM21214595	3862485	RM3588865	3588865	374	RM3862228	3852413	358
RM21214595	21214595				RM3862228	3862228	358
RM21214595		RM3807613	3807613	537-540-541-543-544-545	RM3863189	3863189	513-515-523
RM21214596	3812697	RM3809625	3809625	353-469	RM3883257	3883257	578-579
RM21214596	3858229	RM3809662	3809662	519	RM3883844	1275549	494
RM21214596	3862487	RM3812159	3812159	353-469	RM3883844	3883844	494
RM21214596	21214596	RM3812472	3812472	503	RM3883844		385
RM21214596		RM3812474	3812474	503	RM3884010	3884010	519
RM21226191	3884515	RM3817517	3817517	361	RM3884015	3884015	519
RM21226191	21226191	RM3817517	3828838	361	RM3884517	3884517	504
RM21228429	21228429	RM3817517	3839469	361	RM3884528	3884528	519
RM21252967	21252967	RM3819722		585	RM3884557	3884557	505
RM21255090	3812520	RM3819723		585	RM3884561	3884561	505
RM21255090	21255090	RM3819724		585	RM3885196	3850683	401
RM21277185	3841482	RM3819725		585	RM3885196	3885196	401
RM21277185	3886847	RM3819726		585	RM3885250	3587858	464
RM21277185	21277185	RM3819727		585	RM3885250	3587859	464
RM21301848	21301848	RM3819728		585	RM3885250	3861010	464
RM21314684	21314684	RM3827069	829161	366-368	RM3885250	3885250	464
RM21319767	21319767	RM3827069	829390	368	RM3885250		465-466
RM21325765	842993	RM3827069	3827069	366-368	RM3885324	3885324	506
RM21325765	21325765	RM3827069	21549542	366-368	RM3885870	3885870	354
RM21399021		RM3838952	3827167	365	RM3885870	3885870	583
RM21405494	3583729	RM3838952	3838952	365	RM3888323	3850491	530
RM21407026	21407026	RM3838952		351	RM3888323	3850492	530
RM21412646	21412646	RM3840335	3588378	360	RM3888323	3888323	530
RM21492771	466987	RM3840335	3840335	360	RM3888323		531
RM21492771	829993	RM3840335	21624740	360	RM3889124		348-466
RM21492771	3825133	RM3840525	3589316	367	RM3889127		466
RM21492771	21492771	RM3840525	3840525	367	RM466634	466634	367
RM21548739	3863347	RM3840525		352	RM466634	21707134	367
RM21548739	3863405	RM3841366	3841366	406	RM471034	471034	367
RM21548739	3863406	RM3842015	3842015	353-424	RM477556	471392	368
RM21548739	3863407	RM3847644	3847644	358	RM477556	477556	368
RM21548739	21548739	RM3850430	3850430	347-468	RM477556	21707132	368
RM21608511	3594444	RM3850559	3850559	347-359	RM4785974	423135	367
RM21608511	3860210	RM3851334	3851334	547	RM4785974	4785974	367
RM21608511	3861355	RM3851482	3851482	589	RM478736	478736	368
RM21608511	21545138	RM3851482	21258482	589	RM478736	21707133	368
RM21608511	21608511	RM3851483	3851483	589	RM6210419	6210419	349-424
RM21608511		RM3851483	21258483	589	RM813316	813316	588
RM21610333	3854086	RM3851484	21258484	589	RM813317	813317	588
RM21610333	3857982				RM814611	814611	588
RM21610333	21132437				RM814612	814612	588
RM21610333	21610333	RM3852268	3852268	549-551-552-	RM814615	814615	588
RM21632901	21632901			553-554	RM814616	814616	588
		RM3852288	3852288	436-463			

REF	OEM		REF	OEM		REF	OEM	
RM814626	814626	588	RM875485	875485	503	SOL8651-148-19	3817468	587
RM814627	814627	588	RM875491	875491	505	SOL8652-140-24	3850315	587
RM814628	814628	588	RM875492	875492	505	SOL8652-145-21		587
RM814631	814631	588	RM875747	875747	505	SOL8652-148-17	3817472	587
RM814632	814632	588	RM875748	875748	505	SOL8652-148-19	3817473	587
RM814633	814633	588	RM875750	875750	503	SOL8712-143-21		587
RM826422		440	RM875751	875751	504	SOL8712-145-19		587
RM828254		585	RM875753	875753	504	SOL8712-148-17		587
RM828422		585	RM875773	875773	503	SOL8712-150-15		587
RM828526		585	RM875774	875774	503	SOL8811-142-23		587
RM828527		585	RM875795	875795	352-424	SOL8811-143-21	872004	587
RM829205	818666	429	RM876294	875826	582-583	SOL8811-145-19	872003	587
RM829205	829205	429	RM876294	876294	582-583	SOL8811-148-17	872002	587
RM831834-7	831834	512-522	RM876294	897889	582-583	SOL8811-150-15	872001	587
RM831960	831960	459	RM876512	876512	506-509	SOL8811-153-19	872003	587
RM834337	834337	366	RM876631	875848	582	SOL8811-153-21	872004	587
RM834337	897321	366	RM876631	876631	577-582	SOL8811-155-17	872002	587
RM834337	22057107	366	RM876632	854555	583	SOL8811-158-15	872001	587
RM835440-9	835440	359	RM876632	875747	583	SOL8812-142-23		587
RM835440-9	3852030	359	RM876632	876632	354-577-583	SOL8812-143-21	854990	587
RM835440-9	3852412	359	RM876633	876633	582	SOL8812-145-19	854989	587
RM841750	841750	359	RM876657	876657	504	SOL8812-148-17	854988	587
RM841812	841812	397	RM876658	876658	504	SOL8812-150-15	854987	587
RM843228	843228	528	RM876660	876660	505	SOL8812-153-19	854989	587
RM843228	REC859011	526	RM876661	876661	505	SOL8812-153-21	854990	587
RM847741	847741	367	RM876663	876663	505	SOL8812-155-17	854988	587
RM85108974	85108974	392-592	RM876664	876664	505	SOL8812-158-15	854987	587
RM852904	852904	546-547	RM876666	876666	504	SOL8831-150-15	854996	587
RM852984-4	852984	402-577	RM876667	876667	504	SOL8831-150-17	854997	587
RM854100	854100	555	RM876669	876669	506	SOL8831-150-19	854998	587
RM854133	854133	555	RM876670	876670	506	SOL8831-150-21	854999	587
RM854661	854661	541	RM876672	876672	506	SOL8832-150-15	854981	587
RM854704	854704	402-577	RM876680	876680	506	SOL8832-150-17	854982	587
RM854705	854705	402-577	RM876682	876682	506	SOL8832-150-19	854983	587
RM854977	854977	588	RM876683	876683	506	SOL8832-150-21	854984	587
RM854978	854978	588	RM876685	876685	506	SOL8841-156-15	872001	587
RM854979	854979	588	RM876686	876686	506	SOL8841-156-17	872002	587
RM854982	854982	588	RM877387	877387	504	SOL8841-156-19	872003	587
RM854983	854983	588	RM877388	877388	506	SOL8841-156-21	872004	587
RM854984	854984	588	RM88-79023A91		408	SOL8841-156-23		587
RM854986	854986	588	RM881797	872616	392	SOL8842-156-15	854987	587
RM854992	854992	588	RM881797	881797	392	SOL8842-156-17	854988	587
RM854993	854993	588	RM888624	888624	353-425	SOL8842-156-19	854989	587
RM854994	854994	588	RM9180722	31251996	506	SOL8842-156-21	854990	587
RM854997	854997	588	RM966391		350	SOL8842-156-23		587
RM854998	854998	588	RM966912	966912	349-469	SOL9511-143-21		587
RM854999	854999	588	RM966953	966953	351-469	SOL9511-145-19		587
RM855409	855409	429	RM967114	967114	352-353-469	SOL9511-148-17		587
RM855410	855410	429	RM967191	967191	347-468	SOL9511-150-15		587
RM855423	855423	429	RM967193	967193	350-351-469	SOL9512-143-21		587
RM855428	855428	464	RM973534	973534	352-469	SOL9512-145-19		587
RM855433	855433	429	RM977313	977313	402-555-577	SOL9512-148-17		587
RM855686-2	855686	358	RM978454	978454	347-468	SOL9512-150-15		587
RM855791	831931	429	RM981965	981965	540-541	SOL9513-140-21		587
RM855791	855791	429	RMTUBOVOLVO		401	SOL9513-143-19		587
RM856083	855407	429	S			SOL9513-145-17		587
RM856083	856083	429	SED3090900	861906	526-527	SOL9513-148-15		587
RM856239	831972	464	SED3090900	21190094	526	SOL9531-140-19		587
RM856239	855473	464	SED3091000	845261	526-527	SOL9531-140-21		587
RM856239	856239	464	SED3091200	860656	526	SOL9531-140-23		587
RM857624	857624	404	SED3091200	861289	526-527	SOL9531-143-17		587
RM858955	858729	528	SED3091400	865545	526	SOL9531-145-15		587
RM858955	858955	528	SED3091400	3826841	526	SOL9532-140-19		587
RM858955		524-526	SED3091400	3829668	526	SOL9532-140-21		587
RM859650	859650	518	SED3091400	3830988	526-527	SOL9532-140-23		587
RM859656	859656	518	SED3091600	3587159	526	SOL9532-143-17		587
RM859834	859834	384-385-493-527	SED3091600	3841510	526	SOL9532-145-15		587
RM860396		524-526-528	SED3091600	21684825	526-527	SOL9571-148-23		587
RM860409	860409	430	SED3091600	22671213	526	SOL9571-150-21		587
RM860993	860433	392	SED3091600	22948844	526	SOL9571-153-19		587
RM860993	860434	392	SED3094200		431	SOL9571-155-17		587
RM860993	860435	392	SHE09959K	3854286	346-347-441-442	SOL9571-158-15		587
RM860993	860993	392	SHE10615K	835874	441	SOL9572-148-23		587
RM861473	861473	367	SHEG9901	3851623	440	SOL9572-150-21		587
RM861473	861826	367	SHEG9901	3852398	440	SOL9572-153-19		587
RM861473	3808605	367	SHEG9901	3855778	440	SOL9572-155-17		587
RM861476	859746	367	SHEG9901	3858847	440	SOL9572-158-15		587
RM861476	861476	367	SHEG9903	3851982	440	SOLRBX-105		587
RM861477	861477	360	SHEG9903	3852399	440			
RM861477	3580096	360	SHEG9903	3855079	440	TEN00704BIS	875821	560
RM861477	3841080	360	SHEG9903	3857794	440	TEN00706	851983	560
RM861477	21190113	360	SHEG9903	3817470	587	TEN00706	876286	560
RM861657	861657	430	SOL8611-142-23	3817469	587	TEN00707	832598	561
RM861858		518	SOL8611-143-21	3817468	587	TEN00708	852835	561
RM861859	861859	518-519	SOL8611-145-19	3817467	587	TEN00713	832989	563
RM861906	861906	524-527	SOL8611-148-17	3817466	587	TEN00713T		563
RM861906	21190094	524	SOL8611-150-15		587	TEN00713TP		563
RM861911	861911	352-424	SOL8612-143-21		587	TEN00714	838929	563
RM861954	861954	502	SOL8612-145-19	3817473	587	TEN00714-1		563
RM861955	861955	502	SOL8612-148-17	3817472	587	TEN00714T		563
RM8631650	8631650	519	SOL8612-150-15	3817471	587	TEN00714TPF		563
RM872027	872027	541	SOL8613-140-21	3817469	587	TEN00714TPM		563
RM872363	872363	402	SOL8613-143-19	3817468	587	TEN00715	838929	562
RM872549	872549	547-570	SOL8613-145-17	3817467	587	TEN00716	823661	563
RM872612-7	853439	401	SOL8613-148-15	3817466	587	TEN00716T		563
RM872612-7	854610	401	SOL8614-140-21		587	TEN00716TP		563
RM872612-7	872612	401	SOL8614-143-19	3817473	587	TEN00717	872793	561
RM872612-7		401-402	SOL8614-145-17	3817472	587	TEN00718	3854130	561
RM872614	853655	570	SOL8614-148-15	3817471	587	TEN00719	833913	561
RM872614	854057	570	SOL8641-155-15	3817466	587	TEN00719-1	873411	561
RM872614	854666	570	SOL8642-145-23	3817470	587	TEN00720-1	833915	562
RM872614	872614	547-570	SOL8642-155-15	3817471	587	TEN00721-1		562
RM873183	873183	555	SOL8651-140-24	3850305	587	TEN00722	873395	561
RM875483	875483	503	SOL8651-145-21	3817469	587	TEN00722AL	873395	561
			SOL8651-148-17	3817467	587			



REF	OEM		REF	OEM	
TEN00726	3855411	560	TENKITVOLVO280		563
TEN00726AL	3855411	560	TENKITVOLVO290		563
TEN00728	3858399	562	TENKITVOLVO290-C		564
TEN00732	4100276	562	TENKITVOLVODP280		564
TEN00733	3588746	562	TENKITVOLVODP290		564
TEN00733	3588748	562	TENKITVOLVODP290-C		564
TEN00733	3588750	562	TENKITVOLVODPH/DPR		564
TEN00733BIS	3888814	562	TENKITVOLVOELICA3PAL		564
TEN00734	3888305	561	TENKITVOLVOIPS		564
TEN00734	3888306	561	TENKITVOLVOSX		564
TEN00735	3888814	562	TENKITVOLVOSXA/DPASA		564
TEN00737	3888817	562	TENKITVOLVOXD-B		564
TEN00738	3599981	562	TITAN		586
TEN00739AL	40005875	562	TRI305-0386		371
TEN02022T		510	TRI305-0566		371
TEN02029T	3858995	348-563			

## OEM --> REF

OEM	REF		OEM	REF		OEM	REF	
11010	RECV11010	451	192211	REC477024	508	419643	REC419643	509-518-520
11013	RECV11013	581	192212	REC192212	508	419652	REC3582606	518
11043	REC11043	539	192426	REC477026	508	419653	REC3582561	518-519
11044	REC11044	547-549-551	213244	REC925066	461	419678	REC419678	482
11065	REC11065	539	233033	REC11994	422	419734	REC419734	518
11072	REC11072	546-547	238258	REC238258	412	419735	REC419735	518
11096	REC11096	539	241669	REC241669	412	419763	REC419310	480
11994	REC11994	378-422	241710	REC841262	413	420641	REC22206133	494
12262	REC955976	459-492	243621	REC11994	422	421174	REC1676432	437
12276	REC949658	433	243658	REC243658	412	421306	REC421306	437
12279	REC949721	431-433	243797	REC243797	413	422581	REC469483	462
12288	REC949659	462	243799	REC243799	413	423135	REC127695-35150	367
12291	REC925066	461	243801	RM243801	412	423135	RM4785974	367
12330	REC925096	461	243903	REC243903	413	424299	REC876305	423
17253	REC17253	555-556	270136	REC270136	500	424342	REC469846	462
17276	REC17276	355-539-555-556	270137	REC270137	500	425784	REC425784	539
18671	REC1542159	378	270906	REC270906	500	430017	REC430017	435
18818	REC18818	378	270907	REC270907	500	430018	REC430018	459
18839	REC11994	422	271051	REC271051	500	430020	REC430020	459
18840	REC957181	378	271054	REC271054	500	430039	REC430039	482
23405	REC925068	461-462	271063	REC271063	500	430107	REC9139284	480
38201	REC38201	515	271214	REC271214	500	430143	REC3517857	359-366
82744	REC82744	462-512	271215	REC271215	500	430143	RM3517857	359-366
82745	REC82745	462	271217	REC271217	500	430172	REC430172	458
82812	REC876080	423	271218	REC271218	500	430272	REC430272	459-461
94997	REC949974	433	271975	REC271975	433-435	461056	REC9139284	480
110386	REC11994	422	272002	REC272002	499	461092	REC1378913	482-512
125017	REC125017	355-545-555-556-573	272004	REC272004	499	461113	REC1378914	483
128670	REC128670	571	272040	REC272040	499	461618	REC9139284	480
181538	REC181538	437	272059	REC272059	499	462623	REC9139282	480
181620	REC181620	555	275052	REC875722	502	463225	REC1378879	482
181670	REC1660609	437	275331	REC275331	500	463359	REC1378493	481
181717	REC181717	451	275334	REC275334	499	463371	REC3582609	518
181804	REC181804	539	275336	REC275336	499	463377	REC463377	464-467
183247	REC183247	540-541-543-544-545	275337	REC275337	500	463395	REC463395	518
183272	REC183272	537-547-549-551-552-554	275338	REC275338	500	463412	REC1378645	480
183374	REC183374	546-547	275340	REC275340	499	463505	REC876185	366
183390	REC183390	546	275341	REC275341	499	463526	REC463526	518
183391	REC183391	555	275344	REC275344	499	463587	REC1378864	483
183512	REC31-86748A1	551	275350	REC275350	503-509	463739	REC463739	518-520
183765	REC183765	539	275369	REC275369	500	463828	REC1674083	451
183859	REC183859	537-547-549	275595	REC275751	501	463829	REC1378492	482
183859	REC183859	551-552	275751	REC275751	501	463902	REC463902	508
183861	REC183861	451	352835	REC852835	557	463903	REC463903	508
183959	REC183859	554	358251	MAR512	527	463903	REC477024	508
184642	REC183390	539	388587	RM3885870	354	463904	REC192212	508
184654	REC184654	539-547-549-551-552-554	416033	REC416033	422-426	463905	REC463905	508
184682	REC184682	547-549-551	418262	REC1378864	483	466382	REC466382	519
184683	REC184683	537-551-552-554	418361	REC416033	422	466383	REC466383	519
184683	REC184683	547-549	418411	REC418411	443-459	466384	REC466384	519
184691	RM184691	537-547-551-552-554-549	418412	REC418412	459	466393	REC22206133	494
184765	REC184765	554-549	418423	REC218630	518	466634	REC21707134	367
184778	REC184778	539	418432	REC3517857	359-366	466634	RM466634	367
188486	REC3581774	395	418432	RM3517857	359-366	466987	REC21492771	360
190187	REC976106	433	418445	REC418445	459-527	466987	RM21492771	360
191844	REC191844	577	418737	REC418737	518-520	468305	REC468305	519
			418870	REC1378911	483	469482	REC469482	506
			419310	REC419310	480	469783	REC469483	462
			419628	REC857621	480	469846	REC469846	462

OEM	REF		OEM	REF		OEM	REF	
471034	REC471034	350-351-367	829895	JOH10-35098-3	441-443	838929	TEN00715	562
471034	RM471034	367	829913	REC829913	349-352-360	839195	REC839195	402-555
471392	REC21707132	368	829993	REC21492771	360	839253	REC839253	540-541-545
471392	RM477556	368	831009	RM21492771	360	839423	REC839423	546-570
471956	REC471956	492	831040	REC831009	452	839534	REC839534	546-570
477024	REC477024	508	831106	REC875791	423	840074	REC840074	391
477026	REC477026	508	831178	REC841893	585	840076	JOH10-35157-1	443
477556	REC21707132	368	831239	JOH10-32058-1	439-452	840115	REC840115	490
477556	RM477556	368	831617	REC831239	383	840270	REC3809167	485
478736	REC478736	368	831622	REC831617	459	840328	REC859094	484
478736	RM478736	368	831778	REC831622	439-459	840384	REC840384	451
479956	REC479956	512-513-514-515-517	832598	REC855389	585	840385	REC840385	452
508932	REC982209	415	832598	RM831834-7	512-522	840405	REC859093	485
508935	REC69825302	415	832598	RM855791	429	840440	REC859043	490
802399	REC859120	490	832598	RM831960	459	840442	REC840442	492
803374	REC859015	492	832598	RM856239	464	840461	REC859044	490
803723	REC840785	451	832598	REC831986	465	840557	JOH10-24707-01	443
803762	REC803762	584	832598	REC832191	546	840569	REC840569	484
804186	REC875512	583	832598	REC832534	555-570	840572	REC859042	490
804190	REC804190	581	832598	REC832570	540	840648	REC840648	495
804693	REC840785	451	832598	CM832598	565	840690	MAR690	524-527
804695	REC804695	458	832598	CM832598A	565	840785	REC840785	451
806256	REC831009	452	832598	REC832598	557-558-559	840902	REC840902	492-527
806341	REC806341	510	832598	TEN00707	561	840930	MAR930	525-527
806624	REC806624	577	832669	REC832669	540-541	840944	REC840944	493
807036	REC807036	462	832675	REC832675	540-541-545	840962	REC840962	386
807078	REC807078	389	832820	REC832820	555-568	841031	REC27-8079821	380
807368	JOH10-35157-1	443	832831	REC832831	583	841054	REC982230	358
807368	JOH10-35157-3	443	832846	REC832846	569	841066	REC3854190	393
813316	RM813316	588	832934	CM832934	566	841161	REC841161	372
813317	RM813317	588	832934	REC832934	559	841177	REC841177	407
813967	REC804190	577	832934	REC832934AL	559	841178	BS2141	408
813967	REC813967	577-581	832989	TEN00713	563	841243	REC841243	415
814301	REC814301	569	833070	REC859151	484	841244	REC12532	415
814332	REC814332	555-570	833188	REC833188	518	841262	REC841262	413
814356	REC814356	555-569	833274	REC833274	484	841263	REC841263	413
814388	REC814388	555-568	833323	REC21134777	373	841293	REC841294	381-383
814390	REC814390	555-569	833415	JOH10-35157-1	443	841377	REC50-97499A2	394
814396	REC814396	555-570	833415	JOH10-35157-3	443	841600	REC855297	372
814419	REC814419	555-569	833453	REC859137	484	841676	HGE6894	521
814611	RM814611	588	833522	JOH10-35157-3	443	841676	MAR894	521
814612	RM814612	588	833583	MAR583	525-527	841693	REC841693	451
814615	RM814615	588	833598	REC859145	492	841750	REC841750	346-359
814616	RM814616	588	833637	REC838637	509-519	841750	RM841750	359
814626	RM814626	588	833878	REC833878	451	841812	RM841812	397
814627	RM814627	588	833883	JOH10-35157-1	443	841893	REC841893	585
814628	RM814628	588	833883	JOH10-35157-3	443	841895	REC855389	585
814631	RM814631	588	833913	REC833913	560	841926	REC392-9086T	414
814632	RM814632	588	833913	TEN00719	567	841994	REC841994	381-383
814633	RM814633	588	833915	REC833915	560	842080	REC842080	519
817377	REC817377	418-420	833915	TEN00720-1	562	842280	REC842280	365
818035	REC840648	495	833994	REC833994	452	842586	REC859086	433
818184	REC818184	505	833996	REC833996	458	842645	REC859065	431
818666	RM829205	429	833997	REC840384	451	842669	REC859061	428
819720	REC859140	493	834337	REC834337	366-534	842744	REC858986	461
819723	REC859140	493	834337	RM834337	366	842843	JOH10-24061-3	444
819959	REC819959	452	834438	HOT20930	520	842913	REC842913	524-527
823661	CM823661	567	834751	REC834751	512-514-528	842990	REC859038	494
823661	CM823661A	567	834871	REC834871	510	842993	RM21325765	525-527
823661	TEN00716	563	834975	REC834975	414	843228	RM843228	528
824200	REC3831426	423	835096	REC17930	474-476	843323	REC843323	584
824532	HGE4532	483-510-521	835177	REC876305	423	844084	REC859131	433
824633	REC856044	483	835304	REC391-5090	415	844971	JOH10-24130-3	443
824677	REC824677	380	835308	REC8M6001217	415	845189	REC3829313	444
824912	REC876080	423	835417	REC27-33918	426	845261	MAR261INOX	526-527
824991	REC841893	585	835440	REC35-06003	359	845291	SED3091000	526-527
825582	REC855582	429-461	835440	RM835440-9	359	845291	REC859045	428
825598	HGE5599	522	835550	REC855694	585	845294	REC845294	383
825599	HGE5599	510-522	835576	REC35-53336	358	845301	REC859010	433
826239	REC826239	450	835581	REC835581	426	845353	REC859196	431
826341	REC876278	355-555-568	835702	REC835702	414	845354	REC845354	457
826479	REC908765	380	835704	REC8M6001249	414	845528	HGE5528	524-527
826493	REC826493	372	835705	REC8M6001219	414	845585	REC859047	429
827151	REC827151	391	835779	REC35-06007	359	846037	REC846037	384
827247	REC827247	458	835804	HOT20931	521	846354	REC3829311	444
827250	REC827250	452	835874	CEF500120T	441	846762	REC22637542	407
828023	REC3587508	433	835874	REC10615K	441	847573	REC847573	430
828026	JOH10-32621-2	439	835874	SHE10615K	441	847605	REC847605	391
828140	REC828140	560	835998	REC1463-9382	409	847741	REC847741	350-351-353-367
828726	REC22314183	400	838066	REC838066	490	847741	RM847741	367
829161	REC3827069	366-368	838127	REC859134	484	849270	REC876069	369
829161	RM3827069	366-368	838522	JOH10-24130-3	443	850834	REC850834	399
829205	RM829205	429	838628	REC3582432	486	850888	REC850888	546-560-570-588
829207	REC829207	349-469	838638	REC838638	509-519	850889	REC850889	546-570-588
829214	REC859152	486	838652	REC838652	491-509	851407	REC851407	537-547-549-551-552-554-576
829390	REC3827069	368	838653	REC838653	491-509	851430	REC851430	402-577
829390	RM3827069	368	838654	REC838654	491	851452	REC832846	555
829433	REC829433	444-452	838660	REC876099	502	851983	TEN00706	560
829487	REC829487	495	838766	REC838766	462	852018	CM852018	566
829531	REC859152	486	838807	REC838807	422-425	852018	CM852018A	566
829587	REC829587	389	838929	CM838929A	567	852018	CM852018	560
829592	REC829592	463	838929	CM838929A	567	852018	REC852018AL	560
829714	REC829714	443-459	838929	TEN00714	563			



OEM	REF		OEM	REF		OEM	REF	
852019	REC852019	559	854984	RM854984	588	858065	JOH10-35157-1	443
852019	REC852019AL	559	854984	SOL8832-150-21	587	858150	JOH10-24268-4	443
852206	REC3858457	570	854986	RM854986	588	858464	REC858464	576
852212	REC852212	537-547-549-551-552-554	854987	SOL8812-150-15	587	858467	REC858467	452-444
852565	REC852565	405	854987	SOL8812-158-15	587	858469	JOH10-24277-3	444
852705	REC852705	541-545	854987	SOL8842-156-15	587	858488	REC858488	349-350-365
852835	CM852835	565	854988	SOL8812-148-17	587	858503	REC859155	486
852835	CM852835A	565	854988	SOL8812-155-17	587	858570	REC858570	431
852835	REC852835	557-559-577	854988	SOL8842-156-17	587	858729	CEF500530	528
852835	TEN00708	561	854989	SOL8812-145-19	587	858729	RM858955	528
852839	REC852839	404	854989	SOL8812-153-19	587	858955	CEF500530	528
852868	REC852868	577-581	854989	SOL8842-156-19	587	858955	RM858955	528
852904	RM852904	546-547	854990	SOL8812-143-21	587	858979	REC858979	430
852928	REC852928	398	854990	SOL8812-153-21	587	858986	REC858986	461
852939	REC3819905	408	854990	SOL8842-156-21	587	858992	REC3583786	486
852984	RM852984-4	402-577	854992	RM854992	588	858993	REC3582432	486
853048	REC853048	555-577	854993	RM854993	588	859002	REC859002	527
853175	REC853175	555	854994	RM854994	588	859010	REC859010	433
853223	REC876279	555	854996	SOL8831-150-15	587	859011	REC859011	527
853223	REC876279	568	854997	RM854997	588	859015	REC859015	492
853255	REC75832T	540	854997	SOL8831-150-17	587	859027	REC859027	435-437
853439	RM872612-7	401	854998	RM854998	588	859032	REC861251	495
853484	REC853484	541	854998	SOL8831-150-19	587	859034	REC859034	431
853502	REC3819905	408	854999	RM854999	588	859038	REC859038	494
853542	REC853542	540	854999	SOL8831-150-21	587	859039	REC859039	494
853583	REC23478919	590	855105	CM855105	566	859042	REC859042	490
853588	REC23478969	590	855105	REC855105	559	859043	REC859043	490
853655	RM872614	570	855105	REC855105AL	559	859044	REC859044	490
853670	REC839253	573	855297	REC855297	372	859045	REC859045	428
853759	REC853759	402-577	855380	HGE7037	522	859047	REC859047	429
853760	REC853760	402-577	855380	MAR037	522	859055	REC976039	506
853808	REC853808	537-549-554-576	855384	HOT20935	523	859061	REC859061	428
853846	REC3855650	400	855387	HOT20930	510-520	859065	REC859065	431
853868	REC853868	537-540-541-543-545-576	855389	REC855389	585	859086	REC859086	433
853871	REC853808	576	855405	REC855405	428-429	859093	REC859093	485
854031	REC832846	555	855407	RM856083	429	859094	REC859094	484
854031	REC854031	569	855409	RM855409	429	859107	REC859107	492-525
854040	REC854040	546-548	855410	RM855410	429	859111	REC23557470	494
854045	REC854045	546-570-588	855423	RM855423	429	859120	REC859120	490
854047	REC854047	546-570-588	855428	RM855428	464	859131	REC859131	433
854057	RM872614	570	855433	RM855433	429	859134	REC859134	484
854100	RM854100	555	855473	RM856239	464	859135	REC859135	485
854133	RM854133	555	855506	REC855506	464-467	859136	REC3809167	485
854256	REC21533394	382	855507	REC855507	465	859137	REC859137	484
854346	REC3586765	398	855513	REC855513	483	859140	REC859140	493
854531	REC18525A1	399	855517	JOH10-32621-2	439	859145	REC859145	492
854541	REC854541	546	855578	JOH10-32621-2	439	859150	REC859150	486
854555	RM876632	583	855617	REC855617	585	859151	REC859151	484
854610	RM872612-7	401	855648	REC855648	585	859152	REC859152	486
854661	RM854661	541	855686	REC855686	346-347-356-358	859155	REC859155	486
854666	RM872614	570	855686	RM855686-2	358	859194	REC859194	493
854704	RM854704	402-577	855694	REC855694	585	859196	REC859196	431
854705	RM854705	402-577	855728	REC855728	451	859428	REC859428	373
854765	REC21924262	589	855729	REC17980	474-475	859494	REC859494	376
854766	BVA0990730A	589	855791	RM855791	429	859593	REC873549	395
854766	REC21924263	589	855889	REC823426A1	381-383	859618	REC859618	406
854767	BVA0990740A	589	855926	HOT20931	521	859642	REC859642	502
854767	REC21924264	589	855952	REC982230	358	859647	REC859647	486
854768	BVA0990750A	589	855967	REC855967	483-510	859650	RM859650	518
854768	REC21924265	589	856004	REC856004	426	859656	RM859656	518
854769	BVA0990760A	589	856028	REC856028	510	859726	REC861603	495
854769	REC21924266	589	856033	REC908765	380	859746	REC861476	367
854770	BVA0990770A	589	856034	REC27-33395	474-514	859746	RM861476	367
854770	REC21924267	589	856036	REC856036	512	859791	REC859791	504
854771	REC21924268	589	856042	REC856042	512	859807	REC859807	505
854772	REC21924269	589	856044	REC856044	483-510	859834	RM859834	384-385-493-527
854773	REC21924270	589	856083	RM856083	429	859836	REC859836	526-527
854814	REC21924262	589	856116	REC27-99757	512	859844	REC3582500	373
854815	REC21924263	589	856137	HGE6894	521	859851	REC11994	422
854816	BVB0990630A	589	856137	MAR894	521	859853	REC11994	422
854816	REC21924264	589	856239	RM856239	464	859865	MAR345	525
854817	BVB0990640A	589	856355	REC3819905	408	859945	REC859945	504
854817	REC21924265	589	856365	REC17320	473-475	859949	REC859949	505
854818	BVB0990650A	589	856472	REC856472	381-383	859963	MAR963	524-527
854818	REC21924266	589	856513	REC3860703	440	859963	MAR963INOX	526-527
854819	BVB0990660A	589	856575	REC17040	477	860105	REC20707685	494
854819	REC21924267	589	856609	REC46-8M0113735	433	860320	REC3582310	373
854820	BVB0990670A	589	856616	REC17340	478-518	860339	REC22637542	407
854820	REC21924268	589	856626	REC17935	478-479	860388	REC860388	350-469
854821	REC21924269	589	856659	GS11152	396	860396	CEF500531	528
854932	CEF501001	576	856883	HOT20931	514-521	860409	RM860409	430
854932	REC22303438	354-576	856889	FEL17985	478	860433	RM860993	392
854935	REC854935	512-514	856891	HOT20935	514-523	860434	RM860993	392
854977	RM854977	588	856894	HGE6894	512-521	860435	RM860993	392
854978	RM854978	588	856894	MAR894	512-521	860629	REC3583115	444
854979	RM854979	588	856895	HGE7037	522	860631	REC21880386	430
854981	SOL8832-150-15	587	856895	MAR037	522	860656	MAR289	524
854982	RM854982	588	857037	HGE7037	512-522	860656	MAR289INOX	526
854982	SOL8832-150-17	587	857037	MAR037	512-522	860656	SED3091200	526
854983	RM854983	588	857618	REC857618	512-514	860684	REC861250	495
854983	SOL8832-150-19	587	857621	REC857621	480	860685	REC861251	495
854983		587	857624	RM857624	404	860749	REC3809167	485
			857633	RACS3228UL	357-358	860786	RM3581724	392

OEM	REF	OEM	REF	OEM	REF
860827	REC3583115	444	872241	REC873549	395
860920	REC860920	430	872334	REC872334	577
860993	RM860993	392	872338	REC872338	577
861009	JOH10-24707-01	443	872362	REC872362	402
861019	REC861019	464	872363	RM872363	402
861103	REC861103	376	872549	RM872549	547-570
861250	REC861250	495	872612	RM872612-7	401
861251	REC861251	495	872614	RM872614	547-570
861255	REC861255	377-509	872616	RM881797	392
861260	REC861260	383	872722	REC872722	577
861263	REC861263	430	872752	REC872752	577
861289	MAR289	524-527	872752	REC872752	555-556-569
861289	MAR289INOX	526	872753	REC872753	556
861289	MAR289INOX	527	872756	REC872756	556
861289	SED3091200	526-527	872793	CM872793	566
861407	REC861407	385	872793	CM872793A	566
861413	MAR512	525-527	872793	REC872793	558-559
861414	REC861414	385-493-525-527	872793	TEN00717	561
861431	REC861431	584	872812	REC872812	402-577
861473	REC861473	367	872837	RM3860881	401
861473	RM861473	367	872845	REC872845	577
861474	REC3581621	366	872872	REC3858458	570
861474	RM3581621	366	872891	REC3858457	570
861475	REC3581621	366	872986	REC872986	556
861475	RM3581621	366	873066	REC873066	391
861476	REC861476	367	873183	RM873183	555
861476	RM861476	367	873228	CM873228	404
861477	REC861477	360	873229	REC873229	404
861477	RM861477	360	873395	CM873395	566
861563	REC861563	465-467	873395	CM873395A	566
861564	REC861564	349-350-467-469	873395	REC873395	558-559
861574	MAR345	525	873395	TEN00722	561
861603	REC861603	495	873395	TEN00722AL	561
861657	RM861657	430	873411	TEN00719-1	567
861688	REC861688	377-509	873412	CM873412	567
861698	REC861698	519-509	873413	CM828140	567
861699	REC861699	519-509	873413	REC873413	560
861700	REC861700	507-519	873531	REC22314183	400
861700	REC8631652	519	873534	REC873534	556
861725	REC861725	376	873740	REC22637542	407
861812	RECV11010	451	873765	REC21400091	407
861822	REC861822	495	873770	REC841769	396
861823	REC861823	498	874109	REC3588916	391
861826	REC861473	367	874385	REC3827444	394
861826	RM861473	367	874501	REC21423488	395
861835	REC11994	422	874502	REC874502	396
861859	RM861859	518-519	875031	REC3582597	488
861860	REC861860	507-518	875303	REC875303	505
861865	REC861865	484	875306	REC875306	504
861906	MAR906	524-527	875307	REC875307	504
861906	RM861906	524-527	875320	REC875541	502
861906	SED3090900	526-527	875331	REC875331	505
861907	REC861907	524-526-527	875334	REC875334	504
861911	RM861911	352-424	875383	REC875383	455
861954	RM861954	502	875387	REC875387	497
861955	RM861955	502	875388	REC876417	488
862583	REC124240-01883	452	875400	REC876342	483
863169	REC863169	391	875402	REC876337	480
863344	REC876185	366	875403	REC876306	483
863437	REC3837935	444	875407	REC875407	381-383
863750	REC864315	361	875421	REC875387	497
863946	REC863946	392	875438	REC876416	489
864315	REC864315	361	875439	REC875439	497
865013	REC21325767	525	875483	RM875483	503
865295	REC3838207	447	875485	RM875485	503
865428	REC865428	384	875491	RM875491	505
865545	SED3091400	526	875492	RM875492	505
866396	REC3829313	444	875498	REC875498	502
866653	REC866653	350-351-469	875499	REC875499	502
866835	REC866835	389	875500	REC876377	487
866836	REC866836	389	875501	REC876378	495
867975	REC876099	502	875502	REC876377	487
870690	REC870690	413	875503	REC876389	496
872001	SOL8811-150-15	587	875504	REC876377	487
872001	SOL8811-158-15	587	875505	REC876388	495
872001	SOL8841-156-15	587	875508	REC876379	487
872002	SOL8811-148-17	587	875509	REC876314	496
872002	SOL8811-155-17	587	875512	REC875512	583
872002	SOL8841-156-17	587	875533	REC876337	480
872003	SOL8811-145-19	587	875541	REC875541	502
872003	SOL8811-153-19	587	875543	REC857621	480
872003	SOL8841-156-19	587	875550	REC875550	501
872004	SOL8811-143-21	587	875551	REC875551	501
872004	SOL8811-153-21	587	875553	REC876376	487
872004	SOL8841-156-21	587	875554	REC876384	496
872027	RM872027	541	875561	REC876341	487
872066	REC872066	390	875562	REC876381	496
872082	REC872082	546-570	875567	REC876417	488
872096	REC872096	555-556-568	875569	REC876358	481
872139	CM872139	557-566	875570	REC876337	481
872139	CM872139A	557-566	875571	REC15-404	412
872139	REC872139	559	875572	REC876380	487
872139	REC872139AL	559	875573	REC876383	496
875574	REC875574				455
875575	CEF500170CG	441-442-448-449			441-442-448-449
875575	JOH09-801B	346-349-441-442-448-449			346-349-441-442-448-449
875575	REC875575	439-441-442-448-449-453-455			439-441-442-448-449-453-455
875579	REC875579	501			501
875580	REC875580	346-349-423			346-349-423
875584	REC875584	455			455
875587	REC876300	481			481
875588	REC876393	484			484
875633	REC3582596	489			489
875634	REC876349	497			497
875651	REC227571	501			501
875652	REC875722	502			502
875655	REC875541	502			502
875662	REC3582596	489			489
875676	REC875676	502			502
875678	REC876301	481			481
875697	CEF500145T	449			449
875697	JOH09-814B	449			449
875697	REC875697	449			449
875698	REC875698	454			454
875707	REC875722	502			502
875715	REC876382	496			496
875720	REC876391	535-571			535-571
875722	REC875722	502			502
875747	RM875747	505			505
875747	RM876632	583			583
875748	RM875748	505			505
875750	RM875750	503			503
875751	RM875751	504			504
875753	RM875753	504			504
875756	REC875756	455			455
875757	REC875757	496			496
875759	REC877373	455			455
875769	REC875769	455			455
875773	RM875773	503			503
875774	RM875774	503			503
875781	REC876080	423			423
875783	REC875783	349-424			349-424
875785	REC875785	349-351-352-424			349-351-352-424
875788	REC3831426	423			423
875790	REC876080	423			423
875791	REC875791	423			423
875794	REC876395	423			423
875795	RM875795	352-424			352-424
875796	REC875796	349-423-424			349-423-424
875805	CMV-17	546-565			546-565
875805	CMV-17A	565			565
875805	REC875805	560			560
875805	REC875805AL	560			560
875807	CEF500100GX	441			441
875807	JOH09-806B	441			441
875807	REC3586494	441			441
875809	CMV-16	565			565
875809	REC875809	560			560
875809	REC875809AL	560			560
875810	CMV-15	557-565			557-565
875810	REC875810	560			560
875810	REC875810AL	560			560
875812	CM875812	565			565
875812	CM875812A	565			565
875812	REC875812	560			560
875812	REC875812AL	560			560
875814	CEF500145T	449			449
875814	JOH09-814B	449			449
875814	REC875697	449			449
875815	CMCMV-18	546-557-565			546-557-565
875815	CMCMV-18A	546-557-565			546-557-565
875815	REC875815	560			560
875815	REC875815AL	560			560
875821	CM875821	565			565
875821	CM875821A	565			565
875821	REC875821	546-547-557-558-559-560			546-547-557-558-559-560
875821	REC875821AL	546-547-557-558-559-560			546-547-557-558-559-560
875821	TEN00704BIS	560			560
875822	CEF501011	583			583
875822	REC875822	354-583			354-583
875826	CEF500510K	582-583			582-583
875826	REC876294	582-583			582-583
875826	RM876294	582-583			582-583
875827	REC875512	583			583
875848	CEF500505K	582			582
875848	REC876631	582			582
875848	RM876631	582			582
875849	REC3831424	422			422
876022	REC876302	481			481
876023	REC876448	484			484
876032	REC876427	497			497
876037	REC876037	407			407



OEM	REF	OEM	REF	OEM	REF
876054	REC876054	496	876529	REC877373	455
876069	REC876069	369	876530	REC3583787	489
876070	REC876069	369	876531	REC876774	498
876071	REC876303	481	876544	REC876794	438
876072	REC876304	484	876548	REC876548	502
876073	REC876073	575	876554	REC876554	349-361
876080	REC876080	423-424	876560	REC876793	438
876081	REC875574	455	876588	REC876588	575
876088	REC877373	455	876611	REC876548	502
876097	REC876080	424	876614	REC876614	405
876099	REC876099	502	876631	CEF500505K	577-582
876103	REC3582435	488	876631	REC876631	354
876104	REC3583787	489	876631	REC876631	540
876106	REC876774	498	876631	REC876631	577
876108	REC3582563	494	876631	REC876631	582
876114	REC876114	502	876631	REC876631	556
876120	CEF500104	347-440-442	876631	RM876631	577-582
876120	REC22120-0001	346-347-442	876632	RM876632	354-577-583
876121	REC3582435	488	876633	CEF500505FL	582
876128	REC3831424	422	876633	REC876633	354-540-582
876144	REC876144	493	876633	RM876633	582
876161	REC876161	502	876638	CM876638	557-566
876185	REC876185	366	876638	REC876638	559
876224	REC22011	460	876638	REC876638AL	559
876261	REC22389354	502	876655	REC876655	497
876266	REC876266	540-541-574	876657	RM876657	504
876267	REC876267	547-573	876658	RM876658	504
876268	REC876268	573	876660	RM876660	505
876279	REC876279	568	876661	RM876661	505
876286	CM851983	565	876663	RM876663	505
876286	CM851983A	565	876664	RM876664	505
876286	REC23172849	546-557	876666	RM876666	504
876286	REC876286AL	535-559-560	876667	RM876667	504
876286	TEN00706	560	876669	RM876669	506
876294	CEF500510K	582-583	876670	RM876670	506
876294	REC876294	354-540-541-582-583	876672	RM876672	506
876294	RM876294	582-583	876680	RM876680	506
876300	REC876300	481	876682	RM876682	506
876301	REC876301	481	876683	RM876683	506
876302	REC876302	481	876685	RM876685	506
876303	REC876303	481	876686	RM876686	506
876304	REC876304	484	876689	CEF500100GX	441
876305	REC876305	423	876689	JOH09-806B	441
876306	REC876306	483	876689	REC3586494	441
876307	REC876307	484-487	876774	REC876774	498
876308	REC876308	484-487	876783	REC857621	480
876310	REC876310	485-487	876784	REC22389354	502
876312	REC3582563	494	876793	REC876793	438
876314	REC876314	496	876794	REC876794	438
876317	REC3855650	400	876797	REC876080	423
876335	REC876337	480	876809	REC3837935	444
876337	REC876337	480	876819	REC22389354	502
876341	REC876341	487	876834	REC22389354	502
876342	REC876342	483	876851	REC22185027	502
876349	REC876349	497	876853	REC3583786	486
876356	REC876356	480	877071	REC22185019	502
876358	REC876358	481	877072	REC861700	507-519
876359	REC876337	481	877072	REC8631652	519
876362	REC876774	498	877073	REC861700	507-519
876374	REC876377	487	877073	REC8631652	519
876375	REC876377	487	877349	REC877349	349-424
876376	REC876376	484-487	877355	REC877355	352-424
876377	REC876377	487	877373	REC877373	455
876378	REC876378	495	877387	RM877387	504
876379	REC876379	487	877388	RM877388	506
876380	REC876380	487	877419	REC877419	497
876381	REC876381	496	877765	REC982230	358
876382	REC876382	496	881797	RM881797	392
876383	REC876383	496	885163	REC91-888863	420
876384	REC876384	496	885195	REC885195	590
876388	REC876388	495	888596	REC888596	525-527
876389	REC876389	496	888624	RM888624	353-425
876391	REC876391	535-571	889419	REC889419	362
876392	REC3888917	575	889422	REC889422	362
876393	REC876393	484	889425	REC3831424	422
876395	REC3582596	489	889455	REC889455	539
876398	REC3582595	494	889486	REC889486	491
876416	REC876416	489	889672	REC889672	535
876417	REC876417	488	889970	REC889970	377
876427	REC876427	497	892260	REC829620	518
876430	REC876431	487	897321	REC834337	366
876431	REC876431	487	897321	RM834337	366
876433	REC876393	484	897322	REC859145	492
876448	REC876448	484	897367	REC897367	546-570
876453	REC3582597	488	897426	REC897426	546-576
876507	REC872096	355-568	897682	REC897682	355-540-541
876511	REC876511	506-509	897726	REC897726	581
876512	RM876512	506-509	897816	REC3856008	584
876515	REC876515	505-509	897889	CEF500510K	582-583
876516	REC876516	505-509	897889	REC876294	582-583
876519	REC876519	505-509	897889	RM876294	582-583
876520	REC876520	505-509	905052	REC925052	541
876527	REC22185019	502	906633	REC906633	575
913928	REC9139284	480			
914462	REC914462	437-581			
914515	REC914515	452			
914533	REC914533	581			
925050	REC925050	402-577			
925054	REC925054	535			
925055	REC925055	461			
925060	REC949657	462			
925062	REC949721	431-433			
925064	REC925064	577			
925065	REC949659	462			
925066	REC925066	461			
925067	REC948610	429			
925068	REC925068	461-462			
925091	REC975672	429			
925093	REC925093	443-537-540-541-543-544-545			
925096	REC925096	461			
925255	REC925255	461			
925256	REC925256	535-540-545-546-547-556-573-577			
925258	REC925258	547			
925259	REC925259	539-552-553-554-555-556-573			
925260	REC925260	534-539			
925261	REC925261	546			
926033	REC955976	459-492			
940096	REC1275379	378			
940136	REC940136	512-514			
940191	REC940191	556			
940191	REC940191	539-555			
941807	REC941807	541			
941816	REC941816	540			
941820	REC941820	555			
941870	REC958860	581			
941907	REC941907	535			
941907	REC941907	512-514			
942336	REC942336	512-514			
942547	REC942547	512-514			
942615	REC942615	540			
942791	REC942791	537			
944988	REC944988	378			
945624	REC945624	539			
946056	REC946056	579			
946242	REC946242	581			
946438	REC946438	537-549-551			
946729	REC947620	378			
947620	REC947620	378			
947622	REC947622	378			
947627	REC947627	378			
947893	REC947893	463			
947894	REC997641	463			
947904	REC947904	577			
948255	REC948610	429			
948610	REC948610	429-461			
949187	REC949187	492			
949656	REC949656	534-537-544			
949657	REC949657	462			
949658	REC949658	433			
949659	REC949659	462			
949721	REC949721	431-433			
949722	REC949722	433			
949841	REC949841	494			
949918	REC997641	463			
951924	REC951924	540-541-543			
951936	REC951936	539-544			
952141	REC57-96834Q	468			
952980	REC952980	528			
955103	REC463902	508			
955893	REC955893	549-551-554			
955974	REC955974	355-535-540-541-546-547-573			
955976	REC955976	459-492			
955981	REC955981	355-509-537-549-551			
955988	REC976018	378			
955989	REC955989	355-534-540-541			
956000	REC956000	540-541-545-573			
956590	REC956590	541			
957170	REC957170	378			
957171	REC957171	378			
957181	REC957181	378			
957184	REC957184	378			
958481	DAY17305	469			
958860	REC958860	581			
959794	REC959794	514			
959796	REC959796	512			
960166	REC960166	457			
964106	REC964106	428			
966207	REC966207	402-577			
966382	REC966382	346-467			
966383	REC966383	349-468			
966387	REC966387	469			
966694	REC966694	346-467			

OEM	REF	OEM	REF	OEM	REF			
966698	REC966990	468	1324492	REC1324492	407	3580482	REC3584202	485
966700	REC3858462	468	1324750	REC1324750	389	3580509	REC3580509	352-353-366
966707	REC966707	349-468	1326239	REC1317761	508	3580510	REC3580510	366
966870	GDY15386	352-469	1326785	REC1378646	480	3580514	REC3580514	426
966891	REC966891	346-467	1332644	REC1378646	480	3580546	RM3580546	503
966900	REC966900	352-469	1336385	REC1336385	390	3580547	RM3580547	503
966903	REC966903	352-469	1336753	REC1378870	482	3580586	REC3580586	498
966906	REC3852106	468	1336763	REC1336763	508	3580629	REC11994	422
966906	REC966906	349-350-352-468-469	1357775	REC1674083	451	3580742	REC3583786	486
966912	RM966912	349-469	1359649	REC1359649	531	3580835	REC3580835	469
966914	REC966914	468	1376344	REC1378491	435	3580900	REC3593654	445
966916	REC3852106	468	1378491	REC1378491	435	3580910	REC3593655	445
966929	GDY15545	349-468	1378492	REC1378492	482	3580917	REC3580380	452
966931	REC966931	349-468	1378493	REC1378493	481	3580920	REC3593655	445
966933	REC966933	349-468	1378646	REC1378646	480	3580944	REC3593654	445
966942	REC966942	349-468	1378853	REC1378853	482	3580945	REC3593655	445
966953	RM966953	351-469	1378854	REC1378854	482	3581062	RM3581724	392
966958	GDY15335	351-469	1378864	REC1378864	483	3581114	RM3581114	528
966974	REC57-36356	351-469	1378870	REC1378870	482	3581115	RM3581115	528
966978	REC966978	349-350-469	1378879	REC1378879	482-510	3581150	REC3802092	384
966990	REC966990	468	1378909	REC1378909	482	3581460	RM3581460	349-469
967111	REC967111	346-347-467-468	1378911	REC1378911	483	3581528	REC3581528	384
967114	RM967114	352-353-469	1378913	REC1378913	482	3581536	REC3581536	377-509
967158	GDY17291	467	1378914	REC1378914	483	3581558	REC3583115	444
967191	RM967191	347-468	1378960	REC3582608	518	3581570	REC23557470	494
967193	RM967193	350-351-469	1504952	REC1504952	406-407	3581621	REC3581621	366
967344	REC967344	445-537-541-543-544-545	1542052	REC1542052	492	3581621	RM3581621	366
967643	REC969198	492	1542123	REC1542123	493	3581696	REC3581696	376
967707	REC967707	556	1542157	REC1542157	378	3581714	REC22185027	502
967763	REC969331	458	1542158	REC1542158	378	3581724	RM3581724	392
967944	REC967944	493	1542159	REC1542159	378	3581755	REC3802105	384
968048	REC968048	395	1542170	REC3582310	373	3581760	REC3581760	362-364
968555	REC968555	459	1542177	REC1542177	493	3581774	REC3581774	395
968927	REC968927	422-460	1542187	REC1542187	422-426	3581868	REC21165389	486
968955	REC968955	508	1542198	REC3583913	422-457	3581869	REC21165390	486
969011	REC969011	378	1542219	REC859039	494	3581889	REC3581889	519-520
969071	REC969071	546-547	1542229	REC859027	435	3582310	REC3582310	373
969073	REC969073	546	1542247	REC861251	495	3582324	REC3582324	465-467
969198	REC969198	492	1542263	REC968955	508	3582358	REC21646645	365
969331	REC969331	458	1542287	RM1542287	491-509	3582432	REC3582432	486
969415	REC969415	433-527	1542289	REC859034	431	3582433	REC3583787	486
973534	RM973534	352-469	1542318	REC1542318	498	3582434	REC3582434	488
973593	REC973593	545	1542385	REC976039	506	3582435	REC3582435	488
973639	REC973639	450	1542389	REC1542389	509-518	3582436	REC3583787	489
975309	REC975309	433	1542472	REC1542472	509-518	3582437	REC3583788	489
975672	REC975672	429	1544109	REC859150	486-509	3582458	REC3582500	373
976018	REC976018	378-534	1544119	REC1544119	491-509	3582500	REC3582500	373
976039	REC976039	506	1544124	REC861250	495	3582512	MAR512	525
976041	REC976041	433	1545198	REC1545198	509-518-519-520	3582561	REC3582561	509-520
976051	REC976051	428	1545283	REC1676432	437	3582563	REC3582563	494
976106	REC976106	433	1660609	REC1660609	437	3582595	REC3582595	494
976483	REC976483	350-469	1665251	REC21192875	369	3582596	REC3582596	489
977313	RM977313	402-555-577	1665527	REC1676432	437	3582597	REC3582597	488
977542	REC977542	349-350-469	1674032	REC1676432	437	3582606	REC3582606	520
978454	RM978454	347-468	1674083	REC1674083	451	3582608	REC3582608	520
978457	GDY15295	468	1674084	REC1674083	451	3582609	REC3582609	520
978482	REC978482	352-469	1676432	REC1676432	437	3582639	REC3582639	430
978750	REC978750	346-347-467-468	2170344	CEF500105T	448-449	3582676	REC23557470	494
979254	REC979254	556-569	2170344	JOH09-1029B	350-448-449	3582692	REC22171036	465
980936	REC976039	506	2170344	REC21730344	448	3582694	REC22774756	465
981183	REC981183	378	2194262	REC21924262	589	3582725	REC3582725	492
981650	REC3855276	372	2850245	MP426422	379	3582732	REC3582732	368
981965	RM981965	540-541	3183211	REC3183211	519	3582732	RM3582732	368
984068	REC984068	541-545	3183241	REC85104134	377	3582748	REC3582748	498
984222	REC984222	539	3287677	REC3287677	409	3582768	REC3802149	385
984223	REC984223	539	3501530	REC3501530	375	3582769	REC3802150	385
984224	REC984224	539	3514432	REC3514432	507	3582851	REC860971	498
984225	REC984225	539	3517857	REC3517857	359-366	3582887	REC3582887	535
990899	REC990899	569	3517857	RM3517857	359-366	3582888	REC3582888	535
993436	REC947622	378	3517860	REC3517860	507-518	3582986	REC21457172	430
994130	REC994130	508	3545696	REC3545696	389	3583006	REC3802125	384
997368	REC997368	544	3547560	REC271975	433	3583073	REC3583073	376
997641	REC82745	510	3555413	CEF500380	448	3583078	REC3583078	378
1161995	REC1161995	591	3578536	REC11010	451	3583087	REC3583087	437-438
1218022	REC957181	378	3580026	REC3580026	498	3583089	REC3583089	445
1218630	REC1218630	519	3580064	REC3593654	445	3583115	REC3583115	444
1266286	REC3517857	359-366	3580096	REC861477	360	3583322	REC3583322	535
1266286	RM3517857	359-366	3580096	RM861477	360	3583336	REC3583336	492
1266796	REC1378879	482	3580100	REC3580100	373	3583338	REC21457172	430
1275148	REC271975	433	3580222	REC3593655	445	3583443	REC3583443	361
1275379	REC1275379	378	3580223	REC3593655	445	3583443	RM3583443	361
1275549	RM3883844	494	3580227	REC3580227	495	3583546	REC3583546	491
1276425	REC1276425	498	3580234	REC3580234	485	3583555	REC21323043	394
1276817	REC1378493	481	3580303	RM3580303	518	3583647	REC3583647	428
1306169	REC1306169	413	3580304	RM3580304	518-519	3583654	REC21702999	366
1306341	REC1306341	508	3580305	REC22393048	507-518	3583665	REC22774756	465
1306341	REC994130	508	3580306	REC22393048	507	3583693	RM3583693	503
1306630	REC1306630	507-509-518	3580309	REC3580309	485	3583700	REC3583700	498
1317466	REC416033	422	3580337	RM3580337	503	3583729	RM21405494	353-467-469
1317761	REC1317761	508	3580338	RM3580338	503	3583780	REC3583780	426
1317792	REC1317792	518	3580365	RM3580365	352-424	3583786	REC3583786	486
1317793	REC1317793	518	3580380	REC3580380	452	3583787	REC3583787	489
			3580478	RM21186281	519	3583788	REC3583788	489



OEM	REF	OEM	REF	OEM	REF			
3583840	REC3583840	430	3593656	REC21141637	445	3817467	SOL8611-148-17	587
3583856	MAR701INOX	526	3593656	REC3593659	448	3817467	SOL8613-145-17	587
3583902	MAR847INOX	526	3593663	REC3593663	535-576	3817467	SOL8651-148-17	587
3583913	REC3583913	422-437-457	3593951	REC3593951	531	3817468	SOL8611-145-19	587
3583915	REC21450768	526	3593981	CM3593881	534-557-567	3817468	SOL8613-143-19	587
3584053	REC3802151	386	3593981	CM3593881A	567	3817468	SOL8651-148-19	587
3584062	REC3584062	446-456	3593981	REC3593981	559-558-560	3817469	SOL8611-143-21	587
3584063	REC21380890	446	3593981	REC3593981AL	557-558-559-560	3817469	SOL8613-140-21	587
3584086	RM3584086	353-469	3594159	REC21655254	430	3817469	SOL8651-145-21	587
3584126	REC21132189	373	3594161	REC21655254	430	3817470	SOL8611-142-23	587
3584127	REC3584127	405	3594444	RM21608511	374	3817470	SOL8642-145-23	587
3584138	REC3802152	386	3594509	CEF500537K	582	3817471	SOL8612-150-15	587
3584144	REC3584144	369	3594509	REC3808898	354-582	3817471	SOL8614-148-15	587
3584145	REC3584145	353-369	3594785	REC21608512	374	3817471	SOL8642-155-15	587
3584167	REC3584167	526-528	3594989	REC3594989	400	3817472	SOL8612-148-17	587
3584168	REC3584168	526-527-528	3599981	TEN00738	562	3817472	SOL8614-145-17	587
3584202	REC3584202	485	3660566	REC50-863007A1	393	3817472	SOL8652-148-17	587
3584442	REC2394207AL	561	3762385	REC22273952	584	3817473	SOL8612-145-19	587
3584442	REC3584442	561	3779955	REC22187385	401-402	3817473	SOL8614-143-19	587
3586461	REC3586461AL	557-559	3779955	REC22187386	401	3817473	SOL8652-148-19	587
3586494	CEF500100GX	441-448	3801204	REC3848965	395	3817517	RM3817517	361
3586494	JOH09-806B	441-448	3801296	REC21423488	395	3817687	REC3817687	439-450
3586494	REC3586494	441-448	3801351	REC21323043	394	3817688	REC3817688	440-450
3586722	REC3817861	502	3801404	REC3801404	437	3817861	REC3817861	502
3586758	REC876775	503-509	3801636	REC3801404	437	3818541	REC21702999	366
3586765	REC3586765	398	3803577	REC3884858	396	3818912	REC3818912	435
3586765	REC852928	398	3803645	REC8676498	396	3819016	REC21450768	526
3586857	REC22582994	503	3803648	REC21423488	395	3819485	REC21380886	447
3586871	RM3586871	504	3803650	REC874502	396	3819662	REC874502	396
3586873	RM3586873	504	3803846	REC874502	396	3819905	REC3819905	408
3586877	RM3586877	504	3803855	REC21423488	395	3825038	REC3825038	350-365
3586960	REC3586960	498	3803903	REC874502	396	3825133	REC21492771	360
3587046	REC21655254	430	3803904	REC3840888	395	3825133	RM21492771	360
3587071	REC3587071	396	3803911	REC874502	396	3825493	REC3837935	444
3587072	RM3587072	396	3803929	REC21323043	394	3826841	SED3091400	526
3587079	REC3587079	398	3803938	REC21423488	395	3827069	REC3827069	366-368
3587159	SED3091600	526	3803940	REC3884858	396	3827069	RM3827069	366-368
3587216	REC874502	396	3804296	REC21423488	395	3827167	RM3838952	365
3587410	REC859836	526	3807212	REC21325767	525	3827273	REC3827273	469
3587508	REC3587508	433-435	3807400	REC3807400	560	3827444	REC3827444	394
3587597	REC3587597	347-348-423	3807400	REC3807400AL	560	3828838	RM3817517	361
3587651	RM3587651	511-513-515-516-517-578	3807613	RM3807613	537-540-541-543-544-545	3829311	REC3829311	444
3587858	RM3885250	464	3808228	REC3808228	578-579	3829312	REC3829312	444
3587859	RM3885250	464	3808516	REC892617	388	3829313	REC3829313	444
3587927	REC3843100	390	3808536	CEF500538K	582	3829668	SED3091400	526
3588305	REC22171036	465	3808602	REC3808602	485	3830004	REC876069	369
3588378	REC3840335	360	3808605	REC861473	367	3830459	CEF500163G	448
3588378	RM3840335	360	3808605	RM861473	367	3830459	JAB17938-0001-P	442-447-448
3588432	REC21371112	488	3808616	REC3808616	361-391	3830988	SED3091400	526-527
3588433	REC21371111	489	3808796	REC21250645	389	3831236	REC3831236	367
3588434	REC3588434	497	3808797	REC3808797	389	3831424	REC3831424	422-424
3588435	RM3588435	385-386-493	3808898	CEF500537K	582	3831425	REC3831425	349-350-351-352-424
3588437	RM3588437	425	3808898	REC3808898	539-582	3831426	REC3831426	423-424
3588475	CEF500114T	353-448-449	3809070	REC21457172	430	3836314	REC21380886	447
3588475	JAB17937-0001-P	446-448-449	3809071	REC21457172	430	3837935	REC3837935	444
3588475	REC17937-0001	448-449	3809093	REC21655254	430	3838207	REC3838207	447
3588491	REC21423488	395	3809097	REC21655254	430	3838288	REC3838288	446-456
3588683	MAR684	522	3809167	REC3809167	485	3838942	REC21325767	525
3588684	MAR684	511-522	3809445	REC3809445	590	3838952	RM3838952	365
3588745	CM3588745	565	3809465	REC21280913	465	3839110	REC3839110	350-351-424
3588745	CM3588745A	565	3809559	REC21721548	405	3839469	RM3817517	361
3588745	REC3588745	557	3809560	REC21721550	405	3840181	REC874502	396
3588746	CM3588746	566	3809625	RM3809625	353-469	3840335	REC3840335	360
3588746	CM3588746A	566	3809647	REC3809647	485	3840335	RM3840335	360
3588746	REC3588746	557	3809657	REC3809657	491	3840525	REC3840525	367
3588746	TEN00733	562	3809662	RM3809662	519	3840525	RM3840525	367
3588748	REC3588746AL	557	3809721	REC3809721	361	3840761	REC3840761	579
3588748	TEN00733	562	3809911	REC3801138	386	3840816	REC3840816	353-425
3588750	TEN00733	562	3812109	REC3812109	485	3840842	REC3840842	485
3588753	CEF500538K	354-582	3812131	REC3812131	491	3840843	REC21192973	486
3588770	REC3588745AL	557-558-559	3812159	RM3812159	353-469	3840859	REC3840859	495
3588770	REC852835AL	557-558-559	3812199	REC3812199	485	3840888	REC3840888	395
3588865	RM3588865	374	3812240	REC3812240	440-450	3841011	REC3841011	579
3588879	REC803356	498	3812269	RM3858128	529	3841013	REC3841013	579
3588916	REC3588916	391	3812357	REC3812357	534-573	3841080	REC861477	360
3589104	REC22905155	447	3812472	RM3812472	503	3841080	RM861477	360
3589316	REC3840525	367	3812474	RM3812474	503	3841366	RM3841366	406
3589316	RM3840525	367	3812518	REC21212800	441	3841427	REC3888817	557
3589322	CEF3589322	486-488	3812519	REC21212799	440	3841481	CEF500514K	582
3589522	REC3589522	543	3812520	RM21255090	440	3841481	REC3841481	578
3589524	REC3589524	543	3812522	RM21212798	439	3841481	REC3841481	582
3589544	MAR345	525	3812693	REC21214599	439	3841482	RM21277185	583
3589554	REC3883845	490	3812695	REC21214601	440	3841510	SED3091600	526
3589875	REC3888814	557	3812696	RM21214595	439	3841697	CEF500106GT	449
3589907	REC21380890	446	3812697	RM21214596	440	3841697	JOH09-1028B	449
3593573	CEF500177GT	448	3817033	REC3817033	503-509	3841697	REC3841697	449
3593573	JAB17018-0001	448	3817034	REC22185027	502	3841840	REC21484383	400
3593573	REC3593573	448	3817092	REC40970	395	3842015	RM3842015	353-424
3593654	REC3593654	445	3817328	REC3817328	374	3842442	REC3887328	389
3593655	REC3593655	445	3817466	SOL8611-150-15	587	3842853	REC3842853	513-515-523
3593656	CEF500116GX	448	3817466	SOL8613-148-15	587	3843100	REC3843100	390
3593656	JOH09-1026B	448	3817466	SOL8641-155-15	587	3843136	REC3843136	539
						3843471	REC21256410	584

OEM	REF		OEM	REF		OEM	REF	
3843751	REC3843751	387	3852348	GDY15382	468	3853850	REC46-8M0113734	434-435-436
3843854	REC3843854	386	3852350	REC3852350	548-571	3853854	REC3853854	403-405
3847392	REC3801270	385	3852352	REC3852352	578-583	3853855	REC3853855	403-405
3847393	REC3801271	385	3852362	RM3861459	521	3853856	REC3853856	403-404
3847481	REC22171036	465	3852374	MAR501	521	3853857	REC3853857	403-404
3847482	REC3847482	465	3852390	RM3852390	537-540-541-543-544-545	3853862	REC3853862	585
3847499	MAR499	513-521	3852398	SHEG9901	440	3853915	RM3858873	522
3847501	MAR501	515-521	3852399	SHEG9903	440	3853917	REC3858437	585
3847644	REC3847644	347-348-358-374	3852412	REC35-06003	359	3853934	REC3853934	548-553
3847644	RM3847644	358	3852413	RM835440-9	359	3853945	REC3853945	399
3848896	REC21280913	465	3852418	REC3862228	358	3853962	REC3853962	585
3848965	REC3848965	395	3852418	RM3852418	543	3853982	REC50-99418A2	393
3849006	REC3849006	539	3852454	REC3852454	543	3853983	REC3853983	347-348-423
3849411	REC3863007	400	3852455	REC3852455	472-476-516	3854001	REC3854001	410-420
3849413	REC3863007	400	3852464	REC3852464	468	3854002	REC3854002	409
3850064	REC1674083	451	3852467	REC3852467	513-515	3854002	REC500442	420
3850268	REC3850268	468	3852468	REC27-33395	515	3854003	REC3854003	410-420
3850305	SOL8651-140-24	587	3852472	REC27-46820	517	3854017	REC46-8M0113733	433
3850315	SOL8652-140-24	587	3852472	REC27-46820	478-479	3854018	REC3854018	381-383
3850357	REC806612T	388	3852476	REC3852476	516	3854019	REC984491	358
3850360	REC3850360	423-436	3852477	REC27-34897	435-436	3854020	REC3854020	379-382-383
3850396	REC3850396	387	3852504	RM3852504	468	3854045	HGE8870	520
3850397	REC3850397	390	3852516	RM3852516	543	3854045	MAR870	520
3850426	CEF500528	578-582	3852523	REC332583	578	3854053	REC3854053	372
3850426	REC3850426	354-355-578-582	3852535	REC3852535	578	3854077	REC3854077	419
3850430	RM3850430	347-468	3852537	REC309731	578	3854084	REC84-817376T01	420
3850491	RM3888323	530	3852538	REC3852538	511-512-513-514-515-517-578	3854086	RM21610333	379
3850492	RM3888323	530	3852550	REC3852550	578	3854100	MP425113	518
3850495	REC3850495	511	3852551	REC3852551	578-579	3854105	REC3854105	379-382-383
3850525	REC50-99418A2	393	3852555	REC3852555	400-579	3854106	REC1396-4656	382-383
3850559	REC3850559	359	3852558	REC3852558	579	3854107	REC1396-5238	382-379-383
3850559	RM3850559	347-359	3852560	REC3852560	355-543-578	3854118	REC46-8M0113735	433
3850594	REC3850594	543-575	3852565	REC997368	537	3854127	CEF500514K	582
3850683	RM3885196	401	3852565	REC997368	543	3854127	REC3841481	582
3850740	REC22-73379	513-515-516-517	3852568	REC3852568	543	3854130	CM3854130	566
3850794	RM3858873	522	3852573	RM3852573	403	3854130	CM3854130A	566
3850796	RM3858873	522	3852602	REC3852602	516	3854130	REC3586461AL	578
3850799	BAOMC20-910380	511-522	3852604	G338320	511-5213-515-516-517	3854130	REC3854130	557-559
3850802	REC13980	511	3852607	RM3852607	347-468	3854130	REC3854130	558-578
3850809	REC3858261	375	3852648	REC11-859135	403-543-544-578-579	3854130	TEN00718	561
3850812	REC3850812	543-544	3852687	REC17931	474-476	3854138	REC3854138	406
3850813	REC393831	543	3852696	REC3852696	513-515-516-517-528	3854159	REC3854159	390
3850814	REC3850814	543	3852824	REC27-56880	434-436	3854161	REC3854161	409
3850815	REC59830A7	543	3852830	REC3852830	513-515-516-517	3854164	BS2142	408
3850852	REC3850852	534-537-540-541-543-544-545	3852865	REC3852865	537-548	3854186	BS2143	408
3850853	REC183247	537	3852866	REC3852866	548-549-551-552-553-554	3854190	REC3854190	393
3850913	REC3855271	523	3852958	RM3852958	403	3854194	REC0987883	393-406
3850942	REC3850942	548	3852959	REC3852959	548-548-551	3854217	REC3854217	418
3850984	REC22188	571	3852970	CM3852970	566	3854218	REC3854218	418
3850984	REC22189	571	3852970	CM3852970A	566	3854247	REC3854247	402
3850984	REC398042	548-571	3852970	REC3852970AL	559	3854249	REC31-66668A1	535-537-548-549-551-552-553-554
3851218	REC3862228	358	3853155	REC10-37612	516	3854250	REC31-86748A1	548-549-552-553-554
3851218	RM3862228	358	3853226	REC70817B	507	3854254	BAOMC29-910303	435
3851227	BAOMC-20-3862603	522	3853256	REC27-815528	471-511	3854260	REC3854260	416-420
3851334	RM3851334	547	3853283	REC3853283	380-511	3854261	REC3854261	416-420
3851482	RM3851482	589	3853341	REC3853341	474-476	3854286	CEF500103T	441-442
3851483	RM3851483	589	3853342	REC27-33956	434-435	3854286	REC3854286	441-442
3851623	SHEG9901	440	3853361	REC27-49110	435	3854286	SHE09959K	346-347-441-442
3851982	SHEG9903	440	3853373	REC16-70236	511	3854311	REC3854311	416-420
3852002	REC13-35048	513-515-516-517	3853378	REC3853378	511	3854331	REC3854331	416-420
3852020	REC126870	548-571	3853380	REC17020	473	3854346	MP426422	379
3852030	REC35-06003	359	3853404	REC46335	511-513-515-516	3854427	REC3855269	523
3852030	RM835440-9	359	3853412	REC27-99757	513	3854428	REC3855271	523
3852044	REC25-33145	578	3853423	REC3853423	403-543-578	3854466	MAR061	523
3852045	REC3852045	355-543-544-545-579	3853424	RM3853424	403-543	3854480	REC3854480	537-543*
3852056	REC3852056	355-548-571	3853430	REC3853430	511	3854512	REC8M0077616	388
3852071	REC0307239	426	3853431	REC3853431	511	3854527	REC805223T	390
3852096	REC27-8146801	426-435	3853434	REC3853434	516	3854539	REC22-67892A05	535-543-544-548-552-553
3852106	REC3852106	468	3853510	FEL17986	478-479	3854548	REC3854548	417-420
3852111	REC27-33918	426-436	3853511	REC17042	477	3854549	REC3854549	420
3852135	REC22-428611	513-515-516-517	3853521	REC26-75988	507	3854595	REC3854595	548-549-551
3852142	REC3852142	511	3853536	REC3853536	468	3854601	REC3854601	551
3852165	REC3852165	403	3853567	REC3852569	523	3854624	REC3854624	549-551
3852169	REC331188	578	3853568	REC3855271	523	3854625	REC3854625	549-551
3852215	REC3852215	389	3853587	REC17048	478	RM3854643	RM3854643	347-468
3852217	REC300-00879	409	3853608	RM3853608	528	3854750	REC50-806965A4	393
3852224	REC40155	358	3853628	REC3853628	511	3854809	REC3860769	397
3852268	RM3852268	546-547-548-549-551-552-553-554	3853787	REC806490T	390	3854842	REC3594989	400
3852272	REC3852272	537-543-544	3853796	REC3853796	434-436	3854858	REC8M0073435	372
3852279	REC3852279	543	3853799	REC3853799	347-423	3854874	RM3854874	513-523
3852288	RM3852288	436-463	3853801	REC3853801	414	3854905	REC3854905	388
3852289	RM3852289	435-463	3853804	REC3853804	531	3854956	REC26-34217	507
3852295	REC3852295	537-543-544-545	3853815	REC392-9766	414	3854956	REC26-34217	507
3852296	REC3852296	537-541-543	3853825	RM3853825	404	3855017	REC3855017	381-383
3852315	REC3852315	548-549-551	3853839	REC3853839	405	SHEG9903	SHEG9903	440
3852317	REC3852317	543				3855079		
3852325	REC3856008	584				3855081	REC3855081	355-543-544-545-548-552-553-554
3852329	REC22336734	537				3855182	REC3855182	376
3852336	REC3852106	468				3855184	REC8M0125617	387
3852338	MAR499	521				3855185	REC3855194	387
3852347	BAOMC1-3852347	516-521				3855194	REC3855194	387



OEM	REF		OEM	REF		OEM	REF	
3855269	REC3855269	516-523	3858229	RM21214596	440	3861985	REC3861985	409-421
3855270	MAR061	523	3858261	REC3858261	375	3862014	REC3854549	417
3855271	REC3855271	516-523	3858303	REC3863090	576	3862105	REC3862105	537
3855275	REC3855275	548-574	3858331	MP426422	379	3862168	CEF500538K	582
3855276	REC3855276	372	3858340	REC46-8M0113733	433-435	3862198	MAR061	523
3855279	MP426574	379	3858399	CM3858399	567	3862210	RM3858128	529
3855281	RM3858873	522	3858399	CM3858399A	567	3862228	REC3862228	358
3855296	REC803148	387	3858399	REC3858399	561	3862228	RM3862228	358
3855409	REC9139284	480	3858399	REC3858399	557-559	3862308	REC50-8M0090697	394-406
3855411	CM3855411	566	3858399	REC3858399	557	3862362	REC26-8M0150312	507
3855411	CM3855411A	566	3858399	TEN00728	562	3862385	REC22273952	539
3855411	REC3855411	560	3858457	REC3858457	547-570	3862387	REC3862387	539
3855411	REC3855411	548-549-551-557-558-559	3858458	REC3858458	547-570	3862482	REC21214599	439
3855411	TEN00726	560	3858462	REC3858462	468	3862484	REC21214601	440
3855411	TEN00726AL	560	3858631	RM3858631	578	3862485	RM21214595	439
3855535	REC3863007	400	3858714	REC3858714	375	3862487	RM21214596	440
3855650	REC3855650	400	3858809	REC1504952	407	3862500	REC3862500	390-513-515-517
3855778	SHEG9901	440	3858847	SHEG9901	440	3862513	RM3858128	529
3855805	MP425024	518	3858870	HGE8870	511-520	3862523	REC3862523	463
3855806	MP425036	518	3858870	MAR870	511-520	3862526	REC3862523	436
3855957	MP426766	379	3858871	HGE8870	520	3862612	REC3860082	397
3855983	REC10-37612	516-517	3858871	MAR870	520	3862612	REC3862612	398
3855991	REC46-8M0113735	433-436	3858873	RM3858873	513	3862613	REC3884950	398
3856002	REC3856002	574	3858873	RM3858873	515	3862627	MAR627	513-525-517-523
3856002	REC3856002	548-549-551	3858873	RM3858873	516	3862665	REC3884950	398
3856003	REC50-806965A4	393	3858873	RM3858873	517	3862852	REC3862852	463
3856008	REC3856008	540-541-543-545-584	3858873	RM3858873	522	3862867	REC3862867	539-544
3856069	REC3858458	570	3858873	RM3858873	578	3862904	MAR627	523
3856070	REC3858457	570	3858941	REC3858941	376	3862985	REC50-808011A05	394
3856138	REC17982	474-475	3858969	REC885176	376	3863007	REC3863007	400
3856176	REC3857176	543	3858975	REC898253T22	418-421	3863061	MAR061	513-515-516-517-523
3856366	RM3856366	589	3858977	REC898253013	417-418-421	3863071	BAOMC-20-3862603	511-522
3856367	RM3856367	589	3858979	REC864297T01	388	3863082	REC3863082	539
3856444	MAR061	523	3858984	REC3858984	410	3863083	REC3863083	539-576
3856502	RM3856502	537-540-541-543-545	3858987	REC8M0087834	387	3863084	REC3863084	539
3856617	BAOMC-20-3862603	522	3858995	TEN02029T	348-563	3863085	REC3863085	539-544
3856662	BAOMC-20-3862603	522	3859019	REC898253T23	417-421	3863090	REC3863090	548-553-576
3856839	REC3856844	400	3859020	REC8M0087834	387	3863129	REC3594989	400
3856844	REC3856844	400	3859050	REC3859050	537-572	3863130	REC3863130	388-421
3856961	REC3856961	423	3859066	MP426422	379	3863189	RM3863189	513-515-523
3857079	REC3857079	398	3859078	REC3859078	409	3863191	REC3863191	513-515-516-517
3857140	REC3857140	556	3859082	REC3859082	388	3863193	REC3863193AL	560
3857148	RM3857148	541	3860079	REC3860079	464-466	3863193	REC3863193AL	548-549-551-557-558-559
3857166	REC15-604	412	3860087	RM3860087	347-468	3863347	RM21548739	529
3857166	REC15-801	412	3860092	REC3860092	347-468	3863405	RM21548739	529
3857166	REC15-806	412	3860093	RM3860093	468	3863405	RM21548739	529
3857176	REC3857176	540-541-543-545	3860171	REC3860171	397	3863406	RM21548739	529
3857202	REC21214599	439	3860183	REC3860183	545	3863407	GS38322	513-515-516-517
3857265	REC3586765	398	3860210	RM21608511	374	3863443	REC3863450	511-513-515-516-517-522
3857307	REC3858458	570	3860230	RM3860230	540-541-545	3863450	REC3863450	492-524
3857391	RM3857391	435-463	3860232	REC3860232	541-545	3875050	REC840902	485
3857402	MAR061	523	3860252	RM3860252	548-549-551	3875376	REC859135	485
3857431	RM3857431	403	3860384	REC3860384	354-583	3875382	REC859194	493
3857449	REC805222A1	418	3860703	REC3860703	440	3875384	REC840115	490
3857450	HGE8870	520	3860726	RM3858128	529	3881586	REC21171277	366
3857450	MAR870	520	3860764	REC3885317	393	3883257	RM3883257	578-579
3857470	REC21840806	401	3860769	REC3860769	397	3883777	REC3883777	579
3857470	RM3857470	403	3860795	REC21214601	440	3883784	REC22171036	465
3857471	RM3857471	401	3860798	REC3860082	397	3883786	REC21280913	465
3857487	REC853678T	387	3860808	REC3860808	556	3883844	RM3883844	494
3857489	REC3587079	398	3860842	REC3860842	543	3883845	REC3883845	490
3857521	REC3857521	403	3860842	RM3860842	544	3884010	RM3884010	519
3857522	REC3857522	403	3860842	RM3860842	537-543	3884015	RM3884015	519
3857523	REC3857523	403	3860871	REC3884974	530	3884352	REC3843100	390
3857524	REC3857524	403-404	3860879	REC3587079	398	3884410	REC21945911	404
3857532	REC8M0068784	389	3860881	RM3860881	401	3884512	RM21132989	504
3857533	REC3857533	407	3860883	RM3858128	529	3884515	RM21226191	504
3857588	RM3857588	403	3861010	RM3885250	464	3884517	RM3884517	504
3857648	REC26-8M0150312	507	3861027	REC3586765	398	3884528	RM3884528	519
3857650	REC3857650	374	3861034	REC21132390	347-348-466-468	3884548	REC3884548	491
3857656	MAR499	521	3861068	REC22256171	581	3884557	RM3884557	505
3857662	REC27-807473A1	474-475	3861267	REC3861267	409	3884561	RM3884561	505
3857675	REC3857675	548	3861295	REC15-808	412	3884694	REC21141637	445
3857678	MAR499	521	3861323	REC3859082	388	3884701	MAR701INOX	526-527
3857684	BAOMC-20-3862603	522	3861341	REC46-8M0113736	434-436	3884701	REC21325767	527
3857696	REC3843751	387	3861355	RM21608511	374	3884858	REC3884858	396
3857723	MAR501	521	3861375	REC3861375	407	3884950	REC3884950	398
3857747	REC50-863007A1	393	3861376	REC3861376	406	3884972	REC211010	451
3857794	SHEG9903	440	3861417	RM21214595	439	3884974	REC3884974	530
3857798	BAOMC-20-3862603	522	3861459	RM3861459	517-521	3885196	RM3885196	401
3857810	BAOMC-20-3862603	522	3861556	REC22171	530	3885250	RM3885250	464
3857813	REC3857813	397	3861570	REC883166A2	399	3885317	REC50-863007A1	393
3857835	REC3857835	468	3861575	REC3861575	398-399	3885323	RM3885323	506
3857954	REC3857954	439-440-450	3861634	CM3861634	537-566	3885324	RM3885324	506
3857982	RM21610333	379	3861634	CM3861634A	537-566	3885441	REC21196919	365
3857986	REC3858261	375	3861634	REC3861634	561	3885870	RM3885870	583
3858051	RM3858051	548	3861634	REC3861634AL	561	3886431	REC3886431	485
3858069	REC3587079	398	3861636	CM3861636	566	3886431	REC21171277	366
3858071	REC854525	398	3861636	REC3861636A	566	3886847	RM21277185	583
3858077	REC3858077	399	3861636	REC3861636	560	3886848	REC22905150	447
3858139	REC3860384	583	3861636	REC3861636AL	560	3887328	REC3887328	389
3858212	REC3858212	400	3861837	REC3594989	400	3887373	REC3887373	530
			3861842	MAR061	523			

OEM	REF		OEM	REF		OEM	REF	
3887602	REC3583078	378	13949721	REC949721	431-433	21277185	RM21277185	354-583
3887761	CEF500162G	449	13949722	REC949722	433	21280913	REC21280913	465
3887761	JOH09-821B	449	13955988	REC976018	378	21301848	RM21301848	503
3887761	REC3887761	449	13969011	REC969011	378	21302969	REC21302969	394
3888301	REC21840806	401	14012262	REC955976	459-492	21307714	RM2186282	519
3888305	CM3888305	565	14012279	REC949721	431-433	21310068	REC21310068	519
3888305	CM3888305A	565	14012288	REC949659	462	21314684	RM21314684	353-469
3888305	REC22651246	535	14012291	REC925066	461	21319767	RM21319767	504
3888305	REC22651246AL	535-557-558-559	14023405	REC925068	461-462	21323043	REC21323043	394
3888305	TEN00734	561	14213244	REC925066	461	21325765	RM21325765	525
3888306	TEN00734	561	15442883	REC1676432	437	21325767	REC21325767	525
3888323	RM3888323	530	20450736	REC20450736	425	21344508	REC22774756	465
3888324	REC15-405	412-416-420	20450903	REC947622	378	21351717	REC21351717	377
3888325	REC15-601	412-416-429	20459900	REC947620	378	21354008	REC3801387	385
3888326	REC15-804	412-417-420	20459972	REC969011	378	21363429	REC21363429	591
3888327	REC15-606	412-417-421	20513285	REC20513285	519	21363430	REC21363430	591
3888328	REC15-815	412-418-421	20513343	REC21426987	392	21368879	REC21368879	369
3888460	REC22377272	361	20532237	REC21192875	369	21371111	REC21371111	489
3888555	REC3888555	578-579	20549894	REC947622	378	21371112	REC21371112	488
3888813	CM3883728	566	20707685	REC20707685	494	21379102	REC21379102	445
3888813	CM3883728A	566	20739057	REC20739057	519	21379288	REC21379288	365
3888813	REC23164609AL	552-553-554-557-558-559	20821230	REC3831236	367	21380886	REC21380886	447
3888814	REC3588746	558-559	20856959	RM20856959	506	21380890	REC21380890	446
3888814	REC3888814	552-553-554-557-558-559	20867177	RM20867177	506	21389074	REC877362	354-535-572
3888814	TEN00733BIS	562	20867178	RM20867178	504	21397772	REC21608512	374
3888814	TEN00735	562	20867661	RM20867661	506	21400091	REC21400091	407
3888816	CM3841427	566	20867751	RM20867751	504	21403633	REC21403633	348-558-559
3888816	CM3841427A	566	21106041	REC21379102	445	21405493	REC21405493	469
3888816	REC23164611AL	557-559-579	21108673	REC969011	378	21407026	RM21407026	469
3888817	CM3841427	566	21112496	REC21112496	535-572	21412639	REC21412639	425
3888817	CM3841427A	566	21112497	REC21112497	535-572	21412646	RM21412646	425
3888817	REC23164611AL	557-559-579	21114522	REC38201	513-517	21419374	REC21419374	446-456
3888817	REC3888817	559	21124846	REC879194401	434-435-436	21419376	REC21419376	446-456
3888817	TEN00737	562	21124849	REC21124849	388-472	21423488	REC21423488	395
3888821	REC23022	553-574	21129980	REC50-808011A05	394	21424345	MAR345	525-526-527
3888822	REC23020	552-574	21131568	RM21212801	439	21426987	REC21426987	392
3888916	CEF500536K	355-582	21132189	REC21132189	373	21436799	REC21436799	409
3888916	REC3888916	354-579-582	21132437	RM21610333	379	21450768	REC21450768	526-527
3888917	REC3888917	544-575	21132674	RM21132674	354-530	21457172	REC21457172	430
3889148	REC21457172	430	21132989	RM21132989	504	21484383	REC21484383	400-579
3889484	REC21171277	366	21132990	RM21132990	505	21492771	REC21492771	360
3889517	REC21192974	486	21134777	REC21134777	373	21492771	RM21492771	360
3889782	REC3889782	544	21139810	REC21139810	360	21501189	REC859171	507-509-519
3889784	REC3889784	552-553	21139810	RM21139810	353-360	21505553	REC22663814	529
3889786	REC3889786	552-553-554	21140344	REC3809721	361	21533394	REC21533394	382
3889788	REC3889788	579	21141341	REC21379288	365	21545138	RM21608511	374
3889955	REC22187385	401-402	21141637	REC21141637	445	21545139	REC21608511	374
3889955	REC22187386	401	21146097	REC22663814	529	21548739	RM21548739	529
3889964	MAR964	513-515-517-523	21160912	REC21160912	469	21549542	REC3827069	366-368
3889964	REC3889964	513-515-517-523	21163289	REC3801387	385	21549542	RM3827069	366-368
3889965	MAR964	523	21165389	REC21165389	486	21549544	REC3581621	366
3889965	REC3889964	523	21165390	REC21165390	486	21549544	RM3581621	366
3889982	REC21256410	584	21171277	REC21171277	366	21585053	REC21585053	465
4100276	TEN00732	562	21172053	REC21280913	465	21608511	RM21608511	374
4785974	REC127695-35150	367	21190094	MAR906	524	21610333	RM21610333	379
6210419	RM6210419	349-424	21190094	RM861906	524	21610334	MP426422	379
6600756	RECV11010	451	21190094	SED3090900	526	21610728	REC21655254	430
6601761	REC947620	378	21190113	REC861477	360	21622232	REC21622232	419-421
6603088	REC11994	422	21190113	RM861477	360	21624740	REC3840335	360
6604939	REC11994	422	21192875	REC21192875	369	21624740	RM3840335	360
6613687	REC957184	378	21192973	REC21192973	486	21632901	REC21632901	368
6647311	REC955976	459-492	21192974	REC21192974	486	21632901	RM21632901	368
6842160	REC6842160	498	21196919	REC21196919	365	21633476	PRE3300C05	531
6842273	REC6842273	498	21212798	RM21212798	439	21633477	PRE3300C06	531
6854250	REC31-86748A1	537	21212799	REC21212799	440	21633478	PRE3300C07	531
7011013	RECV11013	581	21212800	REC21212800	441	21633479	PRE3300C08	531
7416033	REC416033	426	21212801	RM21212801	439	21633480	PRE3300C09	531
8149182	REC8149182	353-425	21213660	CEF500107T	442-449	21633481	PRE3300C10	531
8520219	CM852019	566	21213660	CEF500207	448	21633482	PRE3300C11	531
8599252	REC3581774	395	21213660	JOH09-1027B	442-448	21633483	PRE3300C12	531
8631533	REC8631533	388	21213664	REC21213660	439-440-442-448-448	21633484	PRE3300C13	531
8631650	RM8631650	519	21213664	CEF500178G	353-441-442-448-449	21633485	PRE3300C14	531
8631652	REC8631652	519	21213664	REC21213664	439-440-441-442-	21633486	PRE3300C15	531
8642665	REC8642665	491	21214595	RM21214595	448-449	21633487	PRE3300C16	531
8653103	REC8653103	391	21214596	RM21214596	439	21633488	PRE3300C17	531
8658726	REC8658726	388	21214599	REC21214599	440	21633489	PRE3300C18	531
8676498	REC8676498	396	21214601	REC21214601	439	21633490	PRE3300C19	531
8683212	RM31261191	360	21219693	REC3583840	440	21633491	PRE3300C20	531
8692305	REC8692305	347-348-353-359-368	21219723	REC21219723	430	21633492	PRE3300C21	531
8692438	REC8692438	491	21226191	RM21226191	447-456	21633493	PRE3300C22	531
8777066	CEF500135	449	21228429	RM21228429	504	21633494	PRE3300C23	531
8777066	JOH09-819B	449	21250645	REC21250645	486	21633495	PRE3300C24	531
8777066	REC21730344	449	21252967	RM21252967	389	21633496	PRE3300C25	531
9139282	REC9139282	480	21255090	RM21255090	505	21633497	PRE3300C26	531
9671587	GDY17291	469	21256410	REC21256410	440	21633498	PRE3300C27	531
11305263	REC21400091	407	21258482	RM3851482	544-584	21633499	PRE3300C28	531
11991571	REC925068	461-462	21258483	RM3851483	589	21633500	PRE3300C29	531
13947622	REC947622	378	21258484	RM3851484	589	21633501	PRE3300C30	531
13947627	REC947627	378	21258485	RM3856365	589	21633502	PRE3300C31	531
13949657	REC949657	462	21258486	RM3856366	589	21633503	PRE3300C32	531
			21258487	RM3856367	589	21633504	PRE3300C33	531
			21274700	REC21351717	377	21633505	PRE3300C34	531
						21633506	PRE3300C35	531



OEM	REF	OEM	REF	OEM	REF			
21633507	PRE3300C36	531	22197130	RM22197130	579	31293668	REC3801404	437
21633509	PRE3300C38	531	22197130	RM22197130	582	31339213	REC31339213	498
21633511	PRE3300C40	531	22206133	REC22206133	494	31359568	REC31359568	464
21633513	PRE3300C42	531	22222936	CEF500116GX	448	31378645	REC1378645	480
21633515	PRE3300C44	531	22222936	JOH09-1026B	448	31419556	REC31419556	397
21633517	PRE3300C46	531	22222936	REC3593659	448	31430317	REC31430317	491
21633519	PRE3300C48	531	22256171	REC22256171	534-581	35888745	REC3588745	558-559
21633521	PRE3300C50	531	22256625	RM21745117	529	35993659	CEF500116GX	441
21640514	REC3831236	367	22273952	REC22273952	539-584	35993659	JOH09-1026B	441
21641712	REC21880386	430	22283751	REC22283751	469	35993659	REC3593659	441
21646645	REC21646645	365	22297931	REC1359649	531	38622500	REC3862500	511
21652399	REC3858212	400	22303438	CEF501001	535-576	38879363	REC3801173	385
21655254	REC21655254	430	22303438	CEF501011	583	40005192	REC40005192	569
21662702	REC21662702	450	22303438	REC22303438	354-535-576	40005206	CM40005206	567
21684825	SED3091600	526-527	22303438	REC875822	583	40005206	CM40005206A	567
21687472	REC21913334	367	22314183	REC22314183	400-577	40005334	REC40005334	419-421
21687793	REC21687793	592	22336734	REC22336734	539-541-543-544-	40005775	REC40005775	498
21687796	REC21687796	592	22352491	REC22352491	545-555-556	40005875	CM40005875	567
21700014	MAR847INOX	526	22352491	REC22352491	469	40005875	CM40005875A	567
21702999	REC21702999	366	22377272	REC22377272	361	40005875	REC23172849	534
21707132	REC21707132	368	22389354	REC22389354	502	40005875	REC23172849AL	534
21707132	RM477556	368	22393048	REC22393048	507-519	40005875	TEN00739AL	562
21707133	REC478736	368	22430456	REC22430456	554	41100098	CM41100098	567
21707133	RM478736	368	22452003	RM21745117	529	41100098	REC41100098	560
21707134	REC21707134	367	22452005	REC22452005	529	41100098	REC41100098AL	560
21707134	RM466634	367	22479638	REC22479638	591	41100276	CM41100276	567
21711728	REC21711728	503	22479642	REC22479642	591	41100276	CM41100276P	567
21718129	CM21718129	567	22479648	REC22479648	534-592	41103102	REC21687796	592
21718912	REC3583443	361	22479650	REC22479650	592	41103103	REC21687793	592
21718912	RM3583443	361	22557470	REC23557470	494	60112158	REC968955	510
21721548	REC21721548	405	22574246	REC22574246	592	83857561	REC3860171	397
21721550	REC21721550	405	22582994	REC22582994	503	85104134	REC85104134	377
21730348	CEF500177GT	448	22608512	REC21608512	374	85108974	RM85108974	392-592
21730348	JAB17018-0001	448	22612828	REC22612828	554-574	85113732	REC21351717	377
21730348	REC3593573	448	22637542	REC22637542	407	85115324	REC85104134	377
21745117	RM21745117	529	22651246	CM22651246	565	85116162	REC21351717	377
21745119	REC22452005	529	22651246	REC22651246	560	85122800	REC85122800	591
21752712	REC30-879194A01	578	22651246	REC22651246	557-559	85124676	REC85104134	377
21782391	REC21646645	365	22651246	REC22651246AL	560	898253013	REC898253013	417-418
21786692	REC22171036	465	22663814	REC22663814	529	10-812509184	MP0180-001	393-394
21840806	REC21840806	401	22671213	SED3091600	526	10-861788	REC10-861788	393-394
21849843	REC21849843	495	22671214	MAR847INOX	526	13554-0001	CEF500124	441
21868040	REC21868042	560	22677639	REC500MA	364	13554-0001	JOH09-812B	347-348-441-445
21868042	CM21718129	567	22774756	REC22774756	465	13554-0001	REC13554-0001	441
21868042	REC21868042AL	560	22797782	REC1359649	531	22-89771Q2	GS31066	357-370
21880386	REC21880386	430	22898644	REC22898644	590	24-803192A2	REC27-803192A2	434
21910902	RM3858128	529	22898645	REC22898645	590	27-41609	REC27-41609	380
21913334	REC21913334	367	22898646	REC22898646	590	27-60715	REC27-60715	380
21921545	REC21921545	501	22898647	REC22898647	590	27-65577	REC27-65577	380
21924263	REC21924263	589	22905150	REC22905150	447	27-70142	REC27-70142	380
21924264	REC21924264	589	22905155	REC22905155	447	35-809097	LENS3213	357
21924265	REC21924265	589	22915955	REC22915955	501	35-809097	RACS3213	357
21924266	REC21924266	589	22948844	SED3091600	526	35-809097	RACS3214	357
21924267	REC21924267	589	22948847	MAR847INOX	526-527	35-850481	REC500MA	364
21924268	REC21924268	589	22954700	REC22954700	469	35-850481A1	REC500MA	364
21924269	REC21924269	589	22984479	RM23954708	361	35-886638	LENS3227	357
21924270	REC21924270	589	23059414	REC23059414	436-437	35-886638	RACS3227	357
21945911	REC21945911	404	23164609	REC3588746AL	558-559	3863080	REC3863080	539-576
21951302	REC21951302	451	23164611	REC23164611AL	559	+3863081	REC805222A1	420
21951342	CEF500121GX	448-449	23172849	REC23172849	534	805222A1	REC805222A1	420
21951342	JOH09-808B	349-352-448-449	23172849	REC23172849AL	534-557-559	807964A1	REC807964A1	418-420
21951342	REC3586496	441-443-448-449-455	23172856	CM40005875A	557	853807	REC853808	551-552
21951356	CEF500106GT	449	23386773	REC21608512	374	+853808	REC875741	572
21951356	JOH09-1028B	449	23538670	RM23538670	368	876266	REC19037	572
21951356	REC3841697	449	23553896	REC23553896	573	+876267		
21951358	CEF500162G	449	23615636	CM22651246	565	876266		
21951358	JOH09-821B	449	23794966	REC21608512	374	+876268		
21951358	REC3887761	449	23954708	RM23954708	361			
21951362	CEF500135	449	30637961	REC31251252	465			
21951362	JOH09-819B	449	30650525	REC30650525	486			
21951362	REC21730344	449	30659131	REC31419556	397			
21951364	CEF500145T	449	30667118	REC31419556	397			
21951364	JOH09-814B	449	30677767	REC30677767	434			
21951364	REC875697	449	30713459	REC30713459	490			
21951368	REC21951368	443-454	30729340	REC30729340	492			
21951410	REC875769	455	30731261	REC30731261	486			
21951414	REC21951414	443-454	30731262	REC30731262	486			
21951420	REC875698	454	30731263	REC30731263	486			
21951422	REC21951422	443-454	30731264	REC30731264	486			
22024631	REC806612T	388	30731740	RM30731740	503			
22027280	REC40990	395	30731772	REC31359568	464			
22030848	REC3582732	368	30731809	REC30731809	353-467-469			
22030848	RM3582732	368	30750678	RM30750678	503			
22030852	REC21632901	368	30751022	REC3801404	437			
22030852	RM21632901	368	30757056	REC31251252	465			
22057107	REC834337	366	30777600	REC31430317	491			
22057107	RM834337	366	30782228	REC3848965	395			
22063494	REC22063494	447-456	30788490	REC30788490	368			
22171036	REC22171036	465	31216308	REC31216308	387			
22185019	REC22185019	502-509	31251252	REC31251252	465			
22185027	REC22185027	502	31251996	RM9180722	506			
22197130	REC3841481	354	31258305	REC31359568	464			
22197130	RM22197130	354	31261191	RM31261191	360			

<b>SISTEMA ALIMENTACIÓN Y FILTRACIÓN</b>	619
ACCESORIOS PARA FILTROS	623
BOMBA DE COMBUSTIBLE	624
BOMBA DE COMBUSTIBLE ELÉCTRICA	624
BOMBA DE COMBUSTIBLE MECÁNICA	624
CARBURADOR	624
BOYAS	628
CARBURADOR- KITS	626
GUÍA KITS DE CARBURADORES	629
JUNTA BASE	625
FILTRO DE ACEITE	621
FILTRO DE COMBUSTIBLE Y ELEMENTOS	619
BRACKET	619
FILTRO COMBUSTIBLE - SEPARADOR AGUA	619
FILTRO DECANTADOR	619
FILTRO GASOLINA	621
RACOR DE LATÓN	620
MANGUERA CARBURANTE	622
RACORES	622
<b>SISTEMA ELÉCTRICO</b>	630
ALTERNADORES	633
MOTORES DE ARRANQUE	631
REGULADORES	632
SENSORES	630
SENSOR MAP	630
SENSOR PRESIÓN DE ACEITE	630
SENSOR TEMPERATURA DEL AGUA	630
SENSOR TEMPERATURA DEL AIRE	630
SENSOR TPS	630
SOLENOIDE RELÉ	633
SOLENOIDE	633
RELÉ BOMBA GASOLINA ELÉCTRICA	633
TRIM	634
TRIM - LATIGUILLOS	635
TRIM - MOTOR	634
TRIM - SENSOR	635
<b>SISTEMA DE REFRIGERACIÓN</b>	636
BOMBA ASPIRACIÓN DE AGUA	637
TERMOSTATO	636
GUÍA	636
TERMOSTATO	636
TERMOSTATO - CUERPO	637
<b>PARTES DEL MOTOR</b>	644
JUNTAS PARA BASES GM Y FORD	644
<b>SISTEMA ENCENDIDO</b>	638
BOBINAS	638
GUÍA	638
BUJÍAS	639
BUJÍAS	639
CABLES ALTO RENDIMIENTO	639
DISTRIBUIDOR	640
CONDENSADORES	641
KITS ENCENDIDO	642
KITS ENCENDIDO ELECTRÓNICO	643
PLATINOS	642
ROTORES	642
TAPA	640
TAPA - ENCENDIDO ELECTRÓNICO	641
MÓDULO IGNICIÓN	640
MÓDULO SISTEMA CAMBIO	643
<b>SISTEMA ESCAPE Y ADMISIÓN</b>	661
BOMBA DE CIRCULACIÓN	671
BOMBAS	671
MANGUITO	671
COLECTORES Y CODOS ESCAPE	669
JUNTAS	669
JUNTAS COLECTOR ADMISIÓN	670
JUNTAS CODOS	670
JUNTAS TAPA	670
TAPON GOMA	670
TAPA	670
DESPIECES COLECTORES Y CODOS	661
120 HP, 4 CYL 153 CID	661
2.5 GM SERIES 400	661

120HP, 4 CYL 153 CID	662
2.5L GM (1981-86)	663
140HP, 4 CYL 181 CID	663
3.0L GM (1973-90)	664
4.3 H.O. GM 262 CID V6 (1986-90)	664
4.3 GM 262 CID V6 (1991+)	665
800 GM 305 / 350 CID V8	666
5.7L GM 350 CID V8 (1990+)	667
5.0 / 5.8L & EFI FORD 302/351 CID V8 (1991+)	667
7.4 / 8.2L GM 454/502 CID V8 (1991+)	668

<b>UNIDADES DE TRANSMISIÓN</b>	672
ÁNODOS	672
COMPONENTES DE COLA	693
ACOPLAMIENTOS	693
CABLE CAMBIO	694
CABLE CAMBIO ELÉCTRICO	694
CRUCETAS DEL CARDAN	695
EJE HÉLICE, CAMBIO MECÁNICO	695
EJES TRANSMISIÓN	694
FUELLES CABLE DE CAMBIO	693
FUELLES ESCAPE	693
FUELLES TRANSOM	693
KIT ENGRANAJES TRANSOM	694
KIT PIÑONES Y DESPLAZABLES	694
CORREAS	691
DESPIECE COLAS	674
COBRA (1986-93)	674
COBRA (1994-98)	680
400-800 (1973-85)	682
DESPIECE TRANSOM	686
ANTIGUO	687
COBRA (1986-93)	686
HERRAMIENTAS DE COLA	695
ALINACIÓN DE MOTOR	695
KITS REPARACIÓN	688
400-800	688
COLAS	688
EJE BOMBA	689
GOMAS	688
JUNTAS	689
KIT TRANSOM	688
KIT BOMBA	689
RETENES	690
GUÍA AROS TÓRICOS	690
GUÍA RETENES ACEITE	690
GUÍA RETENES COBRA	691
UNIDADES DE TRANSMISIÓN	673
KIT CONVERSIÓN OMC-COBRA	673
PARTE INFERIOR COMPLETA	673

<b>SISTEMA DE PROPULSIÓN</b>	696
HÉLICES AL E INOX DE 3 Y 4 PALAS	696
GUÍA HÉLICES CON NÚCLEO INTEGRADO	697
HÉLICES PARA NÚCLEO INTERCAMBIABLE	697
NÚCLEO INTERCAMBIABLE	697
PIEZAS DE HÉLICE	698
ESPACIADOR	698
KIT CIERRE HÉLICE	699
PASADOR	698
TOPE HÉLICE	698
TUERCA HÉLICE	699
REF --> RO	700
RO --> REF	704

## FUEL & FILTRATION SYSTEM 619

CARBURETOR	624
BASE GASKETS	625
CARBURETORS: GUIDE	628
CARBURETORS: KIT	626
FLAME ARRESTORS	628
FLOAT	628
GUIDE: GASKET KITS	629
FILTER ACCESSORIES	623
FUEL FILTERS AND ELEMENTS	619
BRACKET	619
BRASS RACCORS	620
COMPLETE FUEL FILTER	619
FUEL FILTER	621
WATER SEPARATING FUEL FILTER	619
FUEL HOSES	622
FUEL PUMP	624
ELECTRICAL	624
MECHANICAL	624
OIL FILTER	621
RACOR	622

## ELECTRIC SYSTEM 630

ALTERNATORS	633
REGULATOR	632
SENSORS	630
AIR TEMPERATURE	630
MAP	630
OIL PRESSURE	630
TPS	630
WATER TEMPERATURE	630
SOLENOID & RELAY	633
RELAY FUEL ELECTRIC PUMP	633
SOLENOID	633
STARTERS	631
TRIM	634
HOSES	635
SENSOR	635
TRIM ENGINE	634

## IGNITION SYSTEM 638

DISTRIBUTOR	640
CAP	640
CONDENSERS	641
DISTRIBUTOR	640
ELECTRONIC CONVERSION KITS	643
POINTS	642
ROTORES	642
TUNE UP KITS	642
IGNITION COIL	638
GUIDE	638
IGNITION MODULES	640
SPARK PLUG	639
HD SPARK PLUG WIRES SET	639
SHIFT ASSIT MODULE	643

## COOLING SYSTEM 636

THERMOSTAT	636
THERMOSTAT GUIDE	636
THERMOSTAT KITS	636
WATER PUMPS	637
RAW WATER PUMP	637

## ENGINE PARTS 644

MARINE GASKETS TO GM & FORD ENGINES	644
-------------------------------------	-----

## EXHAUST & INTAKE SYSTEM 661

BLOCK CIRCULATING PUMP	671
HOSE	671
PUMPS	671
MANIFOLDS & ELBOWS	669
COVER	670
COVER GASKET	670
ELBOW GASKET	670
EXHAUST ELBOWS	669
EXHAUST MANIFOLD	669
EXHAUST MANIFOLD GASKET	669
GASKETS	669
INTAKE MANIFOLD GASKET	670
RUBBER CAP	670



<b>MANIFOLDS &amp; ELBOWS PARTS</b>	661	<b>GEAR HOUSING COMPONENTS</b>	693	<b>TRANSOM PARTS</b>	686
120 HP, 4 CYL 153 CID	661	BALL GEAR KIT TRANSON	694	COBRA (1986-93)	686
2.5 GM SERIES 400	661	COUPLERS	693	INTERMEDIATE HOUSING-STRINGER MOUNT	687
120HP, 4 CYL 153 CID	662	DRIVES SHAFTS	694	<b>UNIT DRIVES</b>	673
2.5L GM (1981-86)	662	ELECTRIC SHIFT CABLE	694	CONVERSION KIT OMC-COBRA	673
140HP, 4 CYL 181 CID	663	EXHAUST BELLOWS	693	COMPLETE GEAR HOUSING ASSEMBLY	673
3.0L GM (1973-90)	663	GEAR SETS & CUTCH	694	V-BELTS GUIDE	691
4.3 H.O. GM 262 CID V6 (1986-90)	664	PROP SHAFT MECHANICAL SHIFT	695	<b>PROPULSION SYSTEM</b>	696
4.3 GM 262 CID V6 (1991+)	664	SHIFT CABLE	694	3 & 4 BLADE AL & SS PROPELLERS	696
800 GM 305 / 350 CID V8	665	SHIFT CABLE BELLOWS	693	PROPELLERS APPLICATION WITH RUBBER HUB	697
5.7L GM 350 CID V8 (1990+)	666	TRANSON BELLOWS	693	PROPELLERS SOLAS APPLICATION GUIDE	698
5.0 / 5.8L & EFI FORD 302/351 CID V8 (1991+)	667	U-JOINTS	695	PROP HARDWARE	698
7.4 / 8.2L GM 454/502 CID V8 (1991+)	668	REPAIR KITS	688	COTTER PIN	698
<b>TRANSMISSION UNIT</b>	672	400-800	688	KITS	699
ANODE	672	DRIVES	688	NUT	699
GASKETS	689	PLATE SEAL	688	SPACER	698
DIPSTICK	689	TRANSOM	688	THRUST WASHER	698
OUTDRIVE SEAL COBRA	689	WATER PUMP SHAFT	689	REF --> OEM	700
WATER OUTLET	689	WATER PUMP AGUA	689	OEM --> REF	704
SWIVEL BRG. MECH SHIFT	689	<b>SEALS</b>	690		
SWIVEL BRG. ELECT. SHIFT	689	COBRA SELAS APPLICATIONS	691		
<b>GEAR CASE PARTS</b>	674	O-RING GUIDE	690		
COBRA (1986-93)	674	OIL SEAL GUIDE	690		
COBRA (1994-98)	680	<b>TOOLS</b>	695		
400-800 (1973-85)	682	ENGINE ALIGNMENT TOOL	695		

IT

<b>SISTEMA DI ALIMENTAZIONE E FILTRAZIONE</b>	619	<b>TRIM</b>	634	<b>GUARNIZIONE POMPA</b>	
ACCESSORI PER FILTRI	623	MOTORI	634	GUIDA POMPA ACQUA	
CARBURATORE	624	TUBI TRIM COBRA	635	GUIDA POMPA E TENUTE	
GALLEGGIANTE	628	SENSORE COBRA	635	KIT RICAMBI	
GUARNIZIONE BASE	625	<b>SISTEMA DI ACCENSIONE</b>	638	PIASTRA POMPA	
GUIDA	628	BOBINE	638	TERMOSTATO	636
GUIDA KIT	629	GUIDA	638	KITS	636
KIT	626	CANDELE	639	GUIDA	636
FILTRO ARIA		KIT CAVI CANDELE, ALTE PRESTAZIONI	639	CORPO	637
FILTRI BENZINA E RACCORDI	619	MODULI AVVIAMENTO	640	<b>PARTI MOTORE</b>	644
FILTRO BENZINA	621	MODULO SISTEMA CAMBIO	643	<b>GUARNIZIONI PER MOTORI GM E FORD</b>	644
FILTRO DI DECANTEZIONE BENZINA	619	SPINTEROGENO	640	<b>SISTEMA DI SCARICO E ASPIRAZIONE</b>	661
FILTRO SEPARATORE ACQUA-BENZINA	619	CALOTTE	640	COLLETORE SCARICO	669
RACCORDO IN OTTONE	620	CONDENSATORI	641	GOMITI	669
SUPPORTO	619	ROTORI	642	GUARNIZIONE COLLETORE DI SCARICO	669
FILTRO OLIO	621	PUNTINE	642	GUARNIZIONE COLLETORE ASPIRAZIONE	670
POMPA BENZINA	624	KIT	642	GUARNIZIONE COPERCHIO	670
POMPA BENZINA ELETTRICA	624	KIT DI CONVERSIONE ELETTRICO	643	TAPPO IN GOMMA	670
POMPA BENZINA MECCANICA	624	<b>SISTEMA DI RAFFREDDAMENTO</b>	636	COPERCHIO	670
RACCORDI	622	ANODI		<b>PARTI COLLETTORI E GOMITI</b>	661
TUBO DI CARBURANTE	622	CANADA METAL		120 HP, 4 CYL 153 CID	
<b>SISTEMA ELETTRICO</b>	630	RECMAR		2.5 GM SERIES 400	661
ALTERNATORE	633	TECNOSEAL		120HP, 4 CYL 153 CID	
MOTORINI AVVIAMENTO	631	GUIDA GIRANTE		2.5L GM (1981-86)	662
REGOLATORI	632	KIT TENUTE		140HP, 4 CYL 181 CID	
SENSORE	630	GUIDA KIT TENUTE		3.0L GM (1973-90)	663
SENSORE MAP	630	GUIDA TENUTE		4.3 H.O. GM 262 CID V6 (1986-90)	
SENSORE TPS	630	LIQUIDO INIBITORE DELLA CORROSIONE		4.3 GM 262 CID V6 (1991+)	664
SENSORE PRESSIONE DELL'OLIO	630	POMPA ACQUA	637	800 GM 305 / 350 CID V8	665
SENSORE TEMPERATURA ACQUA	630	BASE		5.7L GM 350 CID V8 (1990+)	666
SENSORE TEMPERATURA ARIA	630	BASE - KIT		5.0 / 5.8L & EFI FORD 302/351 CID V8 (1991+)	667
<b>SOLENOIDI E RELE</b>	633	BOCCOLA		7.4 / 8.2L GM 454/502 CID V8 (1991+)	668
SOLENOIDI	633	CORPO			
RELE POMPA BENZINA ELETTRICA	633	CORPO - KIT			

POMPA DI RICIRCOLO DI BLOCCO	671
POMPE	671
MANICOTTO	671

## UNITÀ DI TRASMISSIONE 672

ANODI	672
ATTREZZATURA	695
ALLINEAMENTO MOTORE	695
COMPONENTI PIEDE	693
ASSE ELICA CAMBIO MECCANICO	695
ASSE TRASMISSIONE	694
CAVO CAMBIO	694
CAVO CAMBIO ELETTRICO	694
CROCIERA	695
CUFFIE CAMBIO	693
CUFFIE SCARICO	693
CUFFIE TRANSON	693
KIT ENGRANAGGIO TRANSON	694
KIT PIGNONI	694
PARASTRAPPI	693
GUIDA CINGHIE	691
GUARNIZIONE	689
ASTICELLA DELL'OLIO	689
CAMBIO ELETTRONICO	689
CAMBIO MECCANICO	689
CHIUSURA COBRA	689
PASSAGGIO DELL'ACQUA	689
KIT RIPARAZIONE	688
400-800	688
ASSE POMPA ACQUA	689
GOMMA TRANSON	688
KIT POMPA ACQUA	689
PIEDI	688
TRANSON	688
PARAOLIO	690
APPLICAZIONI PARAOLIO COBRA	691
GUIDA PARAOLIO	690
GUIDA TENUTE	690
PARTI PIEDI	674
COBRA (1986-93)	674
COBRA (1994-98)	680
400-800 (1973-85)	682
PARTI TRANSON	686
COBRA (1986-93)	686
VECCHIO	687
UNITÀ DI TRASMISSIONE	673
KIT CONVERSIONE OMC-COBRA	673
PORTE INFERIORE COMPLETA	673

## PROPULSION SYSTEM 696

CHIUSURA ELICA	698
DISTANZIALE	698
DADO	699
CHIAVISTELLI	698
FERMO	698
KIT	699
ELICHE ALLUMINIO E INOX DA 3 E 4 PALE	696
GUIDA ELICHE CON MOZZO	697
GUIDA MOZZI	697
REF --> OEM	700
OEM --> REF	704

FR

## SYSTÈME D'ALIMENTATION ET DE FILTRATION 619

ACCESSOIRES POUR FILTRES	623
CARBURATEUR	624
CARBURATEUR - GUIDE DE KITS	629
CARBURATEUR - KIT	626
FLOTTEUR	628
GUIDE DES CARBURATEURS	628
JOINTS DE BASE	625
FILTRE À ESSENCE ET CARTOUCHE DE RECHANGE	619
FILTRE À ESSENCE	621
FILTRE À ESSENCE	619
FILTRE DÉCANTATEUR D'ESSENCE	619
RACCORD EN LAITON	620
TÊTE DE FILTRE	619
FILTRE À HUILE	621
POMPE À ESSENCE	624
POMPE À ESSENCE ÉLECTRIQUE	624
POMPE À ESSENCE MÉCANIQUE	624
RACCORDS	622
TUYAU DU CARBURANT	622

## SYSTÈME ÉLECTRIQUE 630

ALTERNATEUR	633
CAPTEURS	630
MAP	630
TEMPERATURE DE L'AIRE	630
PRESSION D'HUILE	630
TEMPERATURE D'EAU	630
TPS	630
DÉMARREUR	631
REGULATEURS	632
SOLENOIDE RELAIS	633
SOLENOIDE	633
RELAIS POUR POMPE ÉLECTRIQUE	633
TRIM	634
CAPTEUR TRIM COBRA	635
MOTEUR DE TRIM	634
TUYAU	635

## SYSTÈME D'ALLUMAGE 638

ALLUMEUR	640
CONDENSATEUR	641
DOIGT D'ALLUMEUR	642
KITS	642
KITS DE CONVERSION ÉLECTRONIQUE	643
TÊTE D'ALLUMEUR	640
VIS PLATINÉES	642
BOBINE D'ALLUMAGE	638
GUIDE	638
BOUGIES	639
KIT FAISCEAU DE BOUGIE	639
MODULES D'ALLUMAGE	640
MODULES SYSTÈME DE CHANGEMENT	643

## SYSTÈME DE REFROIDISSEMENT 636

POMPE À EAU	637
THERMOSTAT	636
CORS DE THERMOSTAT	637
GUIDE	636
THERMOSTAT	636

## PIÈCES MOTEUR 644

JOINTS POUR MOTEURS GM ET FORD	644
--------------------------------	-----

## SYSTÈME D'ÉCHAPPEMENT ET D'ADMISSION 661

COLLECTEUR D'ÉCHAPPEMENT	669
BOUCHON EN CAOUTCHOUC	670
COUDE D'ÉCHAPPEMENT	669
COUVERCLE	670
JOINTS COLLECTEUR D'ÉCHAPPEMENT	669
JOINTS COLLECTEUR ADMISSION	670

JOINTS COUDES	670
JOINTS COUVERCLE	670
PIÈCES COLLECTEURS ET COUDES	661
120 HP, 4 CYL 153 CID	661
2.5 GM SERIES 400	662
120HP, 4 CYL 153 CID	662
2.5L GM (1981-86)	663
140HP, 4 CYL 181 CID	663
3.0L GM (1973-90)	664
4.3 H.O. GM 262 CID V6 (1986-90)	664
4.3 GM 262 CID V6 (1991+)	665
800 GM 305 / 350 CID V8	666
5.7L GM 350 CID V8 (1990+)	667
5.0 / 5.8L & EFI FORD 302/351 CID V8 (1991+)	668
7.4 / 8.2L GM 454/502 CID V8 (1991+)	671
POMPE DE BRASSAGE	671
DURITE	671
POMPES	671

## EMBASES ET PIÈCES 672

ANODES	672
COMPONENTS D'EMBASES	693
ACCOUPEMENTS	693
ARBRE HÉLICE CHANGEMENT MÉCANIQUE	695
ARBRE TRANSMISSION	694
CÂBLE CHANGEMENT	694
CARDAN	695
KIT PIGNONES	694
KIT PIGNONES TRANSON	694
SOUFFLET CABLE CHANGEMENT	693
SOUFFLET D'ÉCHAPPEMENT	693
SOUFFLET TRANSON	693
EMBASES	673
KIT CONVERSION OMC-COBRA	673
PARTIE INFÉRIEURE COMPLETE	673
GUIDE COURROIES	691
JOINTS	689
CHANGEMENT ÉLECTRONIQUE	689
CHANGEMENT MÉCANIQUE	689
FERMENTURE COBRA	689
SORTIE D'EAU	689
TIGE D'HUILE	689
JOINTS SPI	690
GUIDE JOINTS	690
GUIDE JOINTS SPI	690
GUIDE JOINTS SPI COBRA	691
KITS DE RÉPARATION	688
400-800	688
ARBRE POMPE D'EAU	689
EMBASES	688
JOINT DE TRANSON	688
KIT POMPE D'EAU	689
TRANSON	688
PIÈCES D'EMBASES	674
COBRA (1986-93)	674
COBRA (1994-98)	680
400-800 (1973-85)	682
PIÈCES TRANSON	686
ANCIEN	687
COBRA (1986-93)	686
OUTILS	695
OUTIL D'ALIGNEMENT	695

## SYSTÈME DE PROPULSION 696

HÉLICE ALUMINIUM ET INOX 3 ET 4 PALES	696
GUIDE DES HÉLICES ET MOYEUX	697
MOYEU INTERCHANGEABLE	697
PIÈCES POUR HÉLICE	698
ÉCROU D'HÉLICE	699
ENTRETOISE	698
GOUPILLE FENDUE	698
KIT ÉCROU D'HÉLICE	699
RONDELLE FREIN	698
REF --> RO	700
RO --> REF	704

# SISTEMA DE ALIMENTACIÓN Y FILTRACIÓN FUEL & FILTRATION SYSTEM

## SISTEMA DI ALIMENTAZIONE E FILTRAZIONE SYSTÈME D'ALIMENTATION ET DE FILTRATION

### FILTRO DE COMBUSTIBLE Y ELEMENTOS      FUEL FILTERS AND ELEMENTS      FILTRI BENZINA E RACCORDI      FILTRE A ESSENCE ET CARTOUCHE DE RECHANGE

#### BRACKET

Con 2 tapones de bronce y 2 tubos de extensión. (2 entradas y 2 salidas).

#### BRACKET

With 2 brass plugs and 2 extension tubes. (2 inputs & 2 outputs).

#### SUPPORTO

Con 2 tappi di bronzo e 2 tubi di estensione. (2 ingressi entrata carburante e 2 uscite carburante).

#### TÊTE DE FILTRE À ESSENCE

Avec 2 bouchons en bronze et 2 tubes d'extension. (2 entrées et 2 sorties).

REF		
REC25000	1/4"	AL
REC25010	1/4"	INOX /SS AISI316
REC25020	3/8"	AL
REC25030	3/8"	INOX /SS AISI316
RECOBBRACKET	1/4"	Plast.



REC25000 - REC25020



REC25010 - REC25030



RECOBBRACKET

### FILTRO COMBUSTIBLE SEPARADOR DE AGUA

### WATER SEPARATING FUEL FILTER

### FILTRO SEPARATORE ACQUA-BENZINA

### FILTRE À ESSENCE

REF	OEM
REC35-8M0061975	174144 502905

**RECMAR®**



REF	OEM
RM3862228	987754 502906



### FILTRO CON BRACKET

Con 2 tapones de bronce y 1 tubo de extensión.

### OEM FILTER WITH BRACKET



With 2 brass plugs & 1 extension tube.

### FILTRO BENZINA CON SUPPORTO

Con 2 tappi di bronzo e 1 tubo di estensione.

### FILTRE A ESSENCE AVEC SUPPORT

avec 2 bouchons en bronze et 1 tube d'extension

REF	OEM	MICRON			
REC24950	35-60494A4	25	1/4"	50 GPH	AL



**RECMAR®**

### FILTRO DECANTADOR GASOLINA

Con Bracket Inox y cubeta metálica.

### COMPLETE FUEL FILTER

With Stainless Steel Bracket and metallic bowl.

### FILTRO DECANTATORE BENZINA

Con Bracket e vaschetta metallica.

### FILTRE DÉCANTEUR POUR ESSENCE

Avec support en acier inoxydable et cuvette métallique.

REF	OEM		OEM
RAC320R-RAC-02	35-802893Q4	RACS3220UL	35-809101



**FILTRO DECANTADOR  
GASOLINA**
**COMPLETE FUEL FILTER**
**FILTRO DECANTATORE  
BENZINA**
**FILTRE DÉCANTEUR POUR  
ESSENCE**
**RACOR**

				RAC120R-RAC-01	RAC320R-RAC-01	RAC320R-INOX-01	RAC320R-RAC-02
FLUJO MÁXIMO	MAX. FLOW	FLUSSO MASSIMO	FLUX MASSIMALE	114 l/h 30 gph	340 l/h 60 gph	340 l/h 60 gph	340 l/h 60 gph
ELEMENTO	ELEMENT	ELEMENTO	ÉLÉMENT	RACS3240	RACS3213	RACS3213	RACS3220UL
CAZOLETA TRANSPARENTE (sólo se recomienda para fueraborda.)	CLEAR BOWL (just for outboards)	VASCHETTA TRANSPARENTE (solo nei fuoribordo.)	CAZOLETA TRANSPARENTE (uniquement recommandé pour le hors-bord.)	✓ PLAST.	✓ PLAST.	✓ PLAST.	✗ METAL.
ROSCAS CENTRALES	CENTRAL THREADS	FILETTO CENTRALE	FILS CENTRAUX	M18 x 1.5	1 1/4"	1 1/4"	1 1/4"
TAMAÑO ROSCA CABEZA	HEAD PORT SIZE	DIMENSIONE VITE TESTA	TAILLE DU FIL DE TÊTE	1/4-18 NPTF	1/4-18 NPTF	1/4-18 NPTF	1/4-18 NPTF
ALTURA X Ø	HEIGHT X Ø	ALTEZZA X Ø	HAUTEUR X Ø	166 x 81 x 81 mm	238 x 102 x 102 mm	238 x 102 x 102 mm	238 x 102 x 102 mm
PESO	WEIGHT	PESO	POIDS	0,5 kg	0,9 kg	0,9 kg	0,9 kg
CAIDA DE PRESIÓN	PRESSURE DROP	CADUTA DI PRESSIONE	CHUTE DE PRESSION	0.15 PSI 0.01 bar	0.61 PSI 0.04 bar	0.61 PSI 0.04 bar	0.61 PSI 0.04 bar
PRESIÓN MÁXIMA	MAX. PRESSURE	PRESIONE MASSIMA	PRESSION MAXIMALE	7 PSI 0.05 bar	7 PSI 0.05 bar	7 PSI 0.05 bar	7 PSI 0.05 bar
DESMONTAJE CARTUCHO-CAZOLETA	ELEMENT REMOVAL UNDERBOWL	RIMOZIONE DELLA CARTUCCIA	DÉMONTAGE DE LA CARTOUCHE	25,4 mm 1"	25,4 mm 1"	25,4 mm 1"	25,4 mm 1"
TEMPERATURA DE TRABAJO	OPERATING TEMPERATURE	TEMPERATURA DI LAVORO	TEMPERATURE DE TRAVAIL	-40°C +124°C			

**ELEMENTOS DE  
RECAMBIO**
**ELEMENT**
**ELEMENTI DI RICAMBIO**
**CARTOUCHE DE RECHANGE**

REF	OEM	
RACS3240		RAC120R-RAC-01
LENS3240		
RACS3227	35-886638	
LENS3227		
RACS3213		RAC320R-RAC-01
LENS3213	35-809097	RAC320R-RAC-01 INOX RAC320R-RAC-03
RACS3214	35-809099	
RACS3228UL		RAC320R-RAC-02, bracket RACOR

 LENS3240  
LENS3227  
LENS3214

 RACS3240  
RACS3227  
RACS3214

RACS3228UL

**RÁCORES DE LATÓN**
**BRASS RACORS**
**RACCORDI IN OTTONE**
**RACCORDS À LAITON**

REF	OEM			
GS31066	22-89771Q2	1/4" NPT	5/16" = 7.9 mm	2
GS31067		1/4" NPT	3/8" = 9.5 mm	2

**GOLDENSHIP**

REF			
GS31065	1/4" NPT	3/8" = 9.5 mm	1
GS31066	1/4" NPT	5/16" = 7.9 mm	2
GS31055	3/8" NPT	3/8" = 9.5 mm	2
GS31056	3/8" NPT	5/16" = 7.9 mm	2
GS31157	3/8" NPT	1/4" = 6.4 mm	2





FILTRO GASOLINA

FUEL FILTER

FILTRO BENZINA

FILTRE À ESSENCE

REF	OEM
REC35-53336	908034



REF	OEM
REC35-49088A2	312456 381690



REF	OEM
REC984491	984491



REF	OEM
REC982230	982230



REF	OEM
REC981911	981911



REF	OEM
REC1397-2150	983870



FILTRO DE ACEITE

OIL FILTER

FILTRO OLIO

FILTRE A HUILE

REF	OEM	Icon
REC35-06003	778864	4L GM



REF	OEM	Icon
REC35-06004	173834 502903	V6 GM



REF	OEM	Icon
REC35-06007	502900	2.3L, V8, 302, 351



REF	OEM	Icon
RACS3228UL	173233 502901	V8 GM



REF	OEM	Icon
REC502900	502900	2.3L, V8, 302, 351 Ford



REF	OEM	Icon
REC3517857	174796 502904	Ford 7.5L / 460





## RACORS

## RACORS

## RACCORDI

## RACCORDS

REF		
GS30430	8 mm	2
GS30431	10 mm	2

**GOLDENSHIP**



ORIENTABLES  
GUIDEBLE  
ORIENTABILE  
ORIENTABLE

REF		
GS30432	8 mm	2
GS30433	10 mm	2

**GOLDENSHIP**



REF						
RAC1/2X16	1/2"	16 mm				1
RAC1/2X18	1/2"	18 mm	500			1
RAC1/2X20	1/2"	20 mm	900			1
RAC3/8X10	3/8"	10 mm	1000			1
RAC3/8X12	3/8"	12 mm				1
RAC3/8X14	3/8"	14 mm				1

**RACOR**



REF	NPT		
BRA125-3/16x1/4	1/4"	3/16"	1
BRA125-1/4x1/2	1/2"	1/4"	1
BRA125-5/16x3/8	3/8"	5/16"	1
BRA125-3/8x3/8	3/8"	3/8"	1
BRA125-3/8x1/2	1/2"	3/8"	1
BRA125-1/2x3/8	3/8"	1/2"	1
BRA125-1/2x1/2	1/2"	1/2"	1
BRA125-1/2x3/4	3/4"	1/2"	1
BRA125-5/8x3/8	3/8"	5/8"	1
BRA125-5/8x3/4	3/4"	5/8"	1
BRA125-3/4x3/4	3/4"	3/4"	1
BRA125-1x3/4	3/4"	1"	1
BRA125-1/4x3/8	1/4"	3/8"	1



REF	NPT	NPT			
RAC1/2F-1/2M	7/8"	1/2"	900		1
RAC3/8F-3/8M	3/4"	3/8"	1000		1
			500		1

**RACOR**



REF			
GS31066	1/4" NPT	5/16" = 7.9 mm	2
GS31055	3/8" NPT	3/8" = 9.5 mm	2
GS31056	3/8" NPT	5/16" = 7.9 mm	2

**GOLDENSHIP**



## MANGUERA CARBURANTE

## FUEL HOSE

## TUBO DI CARBURANTE

## TUYAU DU CARBURANT

Tubo de goma para el transporte de carburante (diesel o gasolina). Construida en goma negra (NBR). Contenido aromático no superior al 60%. Resistente a la abrasión de los agentes marinos.

Long length rubber hose, suitable for loading diesel, bio-diesel and unloading fuel for marine pleasure craft inboard engines up to 24 m.

Tubo in gomma per il passaggio di carburante (diesel o benzina). In gomma nera (NBR). Per motori entrobordo su imbarcazioni da diporto fino a 24m.

Tuyau en caoutchouc pour le passage du carburant (diesel ou essence). Caoutchouc noir (NBR). Pour moteurs in-bord sur bateaux de plaisance jusqu'à 24m.

### CARBO/7840/A1

REF	Ø (mm)						
GS35049	6x16	14 bar	35 mm			40 m	
GS35050	8x17	14 bar	50 mm			40 m	
GS35051	10x19	14 bar	60 mm			40 m	
GS35052	12x22	10 bar	75 mm	-30°C ~ 100°C	30 bars	20 m	Rina CE 0474 Lloyd's Register 96/00/127
GS35053	16x26	10 bar	100 mm			40 m	
GS35054	19x30	10 bar	115 mm			20 m	
GS35055	25x37	10 bar	250 mm			x m	

**ht**  
hoses technology

SAE J 1527 - 2004

USCG A1 R1

ISO 7840 A-1 2004 CE



De goma para diesel y gasolina sin plomo. Ideal para fueraborda. Refuerzos textiles internos. Muy flexible. Contenido aromático 50%.

Rubber Hose suitable for loading mineral oils, diesel and unleaded fuel

In gomma per diesel e benzina senza piombo. Ideale per motori fuoribordo. Tessuto interno rinforzato. Molto flessibile.

En caoutchouc pour diesel et essence sans plomb. Idéal pour les moteurs hors-bord. Tissu intérieur renforcé. Très flexible.

### CARBUPOMP/10NL

REF	Ø (mm)				
GS35031	6x12	10 bar	50 mm	-25°C ~80° C	50 m
GS35032	8x15	10 bar	65 mm		50 m

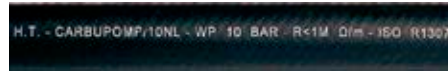

ISO R1307

Manguera para líneas de combustible. Con refuerzo termoplástico que le permite excelente flexibilidad y resistencia a los rayos UV. Color gris. Resistente al alcohol. Especialmente indicado para motores fueraborda.

Marine fuel hose for outboards. Fuel resistant thermo-plastic formulation with 2 spiral reinforcement provides excellent bendability and resistance to UV, aging and permeation by all marine fuels (gasoline/petrol and diesel) including alcohol blends.

Tubi per il condotto del carburante. Con rinforzo termoplastico che gli permette un'eccellente flessibilità e resistenza ai raggi UV. Resistente alle miscele di alcool. Indicato per motori fuoribordo.

Tuyau de carburant marin. La formulation thermoplastique avec 2 renforts en spirale offre une excellente flexibilité et résistance aux UV, au vieillissement et à la perméation de tous les carburants marins (essence et diesel), y compris les mélanges d'alcool.

REF	Ø		
TRI305-0566	8 mm 5/16"	15 m	1
TRI305-0386	10 mm 3/8"	15 m	1

SAE J1527  
ISO-8469 B1



## ACCESORIOS PARA FILTROS

## FILTER ACCESSORIES

## ACCESSORI PER FILTRI

## ACCESSOIRES POUR FILTRES

### LLAVES PARA FILTRO

### FILTER KEY

### CHIAVE DA FILTRO

### CLÉ À FILTRE

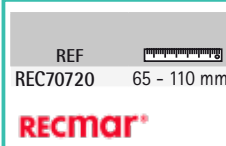
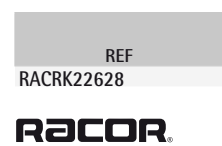

### VÁLVULA DRENAJE AGUA DE FILTROS RACOR

### DRAIN VALVE FOR RACOR FILTERS

### VALVOLA DRENAGGIO ACQUA PER FILTRI RACOR

### VANNE DE DRAINAGE D'EAU POUR FILTRE RACOR



### SENSOR DE AGUA PARA FILTROS DIESEL

### WATER SENSOR FOR DIESEL FILTERS

### SENSORE ACQUA PER FILTRI DIESEL

### SONDE DE PRESENCE D'EAU POUR DIESEL

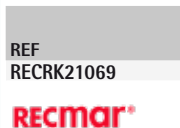

### RELOJ SENSOR DE AGUA

### WATER ALARM

### ALLARME SENSORE ACQUA

### ALARME SENSOR D'EAU



**BOMBA COMBUSTIBLE MECÁNICA**

**MECHANICAL FUEL PUMP**

REF	OEM	
REC3855276	981650	GM V8, 305, 307, 350



REF	OEM	
REC62092T	982063	FORD V8, 302



**POMPA COMBUSTIBILE MECCANICA**

**POMPE CARBURANT MÉCANIQUE**

REF	OEM
REC86234A4	985603 982240 985602



REF	OEM
REC982997	982997





**BOMBA COMBUSTIBLE ELÉCTRICA**

**ELECTRICAL FUEL PUMP**

**POMPA COMBUSTIBILE MECCANICA**

**POMPE CARBURANT MÉCANIQUE**

REF	OEM		
REC3858261	3858261 3857986 3854620	432, 434, 502, 52 43f, 50f, 57f	8 PSI



new

**CARBURADORES**

**CARBURETORS**

**CARBURATORE**

**CARBURATEUR**

REF	OEM	
REC1347-818619R02	382733 980530 982217 984180 381498 772831	ROCHESTER 2 BB









REF	OEM	
REC1347-816373A4	981705	ROCHESTER 4 BB
	982223	
	983855	
	981359	
	982215	
	981564	
	985822	
	981803	
	981428	

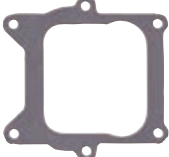



REF	OEM	
REC1347-9661A3	382821	ROCHESTER 4 BB
	383766	
	384194	

REF	OEM	
MP426422	3854087	3.0L (1991-94) 2.0L HO
	772846	

REF	OEM	
RM21610333	3854086	3.0L (1995-97)





**JUNTAS BASE      BASE GASKETS      GUARNIZIONE BASE      JOINTS DE BASE**

REF	OEM	
REC315055	315055	ROCHERSTER
REC27-8079821	909758	
REC3853283	3853283	
REC908765	908765	

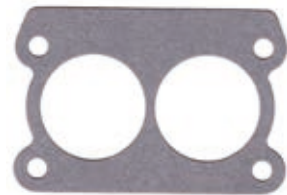

REC315055



REC27-8079821



REC3853283



REC908765

KITS DE CARBURADOR

CARBURETORS KITS

KIT CARBURATORE

CARBURATEURS KIT

REF	OEM
REC1396-5238	982539

REF	OEM
REC1397-6367A1	508459

REF	OEM
REC823427A1	982384

REF	OEM
REC823426A1	979659
	384743
	983864
	383918

REF	OEM
REC1397-5831	508452

REF	OEM
REC1396-4656	982537
	982538
	982538

REF	OEM
REC841994	984487
	983073
	983073

REF	OEM
REC982386	381400
	982386



REF	OEM
REC985052	985052

REF	OEM
REC2153394	987438 987440 987485 2153394

REF	OEM
REC986799	986784 986799



REF	OEM
REC3854105	987313 3854105

REF	OEM
REC823427A1	982384

REF	OEM
REC3854020	986796 3854020 3854347

REF	OEM
REC986782	986782

REF	OEM
REC987315	987315

BOYAS		FLOATS	GALLEGGIANTI		FLOTEURS
REF	OEM		REF	OEM	
REC1397-3327	383087 983871		REC1397-2060	381389	

GUÍA CARBURADORES	GUIDE CARBURETORS	GUIDA CARBURATORI	GUIDE DES CARBURATEURS
-------------------	-------------------	-------------------	------------------------

		COD.	CARB.	OEM.
80	1968-69	R2, 2GC	REC1347-818619R02	382733 772831
90	1970-71	R2, 2GC	REC1347-818619R02	382733 772831
155	1967-72	R2, 2GC	REC1347-818619R02	772831
165	1972-76	R2, 2GC	REC1347-818619R02	979821 98053
185	1989	R2, 2GC	REC1347-818619R02	984180
200	1966-68	R2, 2GC	REC1347-818619R02	381494
210	1968-72	R4, 4MV	REC1347-9661A3	382821 383766
215, 225, 230	1971-76	R4, 4MV	REC1347-9661A3	382821
230 (800 Series)	1979-89	R4, 4MV	REC1347-816373A4	981705 982223
245	1972-75	R4, 4MV	REC1347-9661A3	384194
250	1970-74	R4, 4MV	REC1347-9661A3	384194
260 (800 Series)	1975-76	R4, 4MV	REC1347-9661A3	384194
260 (800 Series)	1979-89	R4, 4MV	REC1347-816373A4	982223
3.0L	1991-94		MP426422	772846
3.0L	1995-97		RM21610333	3854086
3.8L (4V)	1979-85	R4, 4MV	REC1347-816373A4	983855
4.3L (4V)	1979-89	R4, 4MV	REC1347-816373A4	983855
5.0L (GM)(4V)	1979-89	R4, 4MV	REC1347-816373A4	982223
5.7L (4V)	1979-89	R4, 4MV	REC1347-816373A4	982223 981359
305, 350 CI, I/B,	1977-83	R4, 4MV	REC1347-816373A4	982215 981564 982223
350 (4V)	1988-89	R4, 4MV	REC1347-816373A4	985822
454 CI, I/B	1977-78	R4, 4MV	REC1347-816373A4	981803 981428



		COD.	MOD.	KIT	
80	1968-69	R2	2GC	REC823427A1	REC1397-2060
90	1970-71	R2	2GC	REC823427A1	REC1397-2060
100	1972-73	C1	RBS	REC1398-3089	
120	1965-71	C1	RBS	REC1398-3089 (2 CARB)	
120	1972-85	R2	2GC	REC982386	REC1397-2060
140	1973-85	R2	2GC	REC823427A1	REC1397-2060
155	1967-72	R2	2GC	REC982386	
165	1972-76	R2	2GC	REC823427A1	REC1397-2060
170	1974	H2	2300	REC1396-4656	
175	1975-77	H2	2300	REC1396-4656	
185	1978-81	R2	2GE	REC841994	REC1397-2060
185	1989	H2	2300	REC1396-4656	
190	1974-77	H2	2300	REC1396-4656	
200	1966-68	R2	2GC,V	REC982386	
200	1979-85	R2	2GE	REC841994	REC1397-2060
200	1989	H2	2300	REC1396-4656	
210	1968-72	R4	4MV	REC823426A1	REC1397-3327
215	1971	R4	4MV	REC823426A1	REC1397-3327
225	1972-76	R4	4MV	REC823426A1	REC1397-3327
230	1975-76	R4	4MV	REC823426A1	REC1397-3327
230	1979-89	R4	4MV	REC823426A1	REC1397-3327
235	1975-77	H4	4160	REC1396-5238	
235	1989	H4		REC985052	
240	1978	H4		REC985052	
245	1972-75	R4	4MV	REC823426A1	REC1397-3327
250	1970-74	R4	4MV	REC823426A1	REC1397-3327
250	1979	H4		REC985052	
260	1975-76	R4	4MV	REC823426A1	REC1397-3327
260	1979-89	R4	4MV	REC823426A1	REC1397-3327
290 JET	1974-75	R4	4MV	REC823426A1	REC1397-3327
2.3 L	1987-89	R2	2GE	REC841994	REC1397-2060
2.5L	1982-85	R2	2GC	REC982386	REC1397-2060
2.5L	1986-90	R2	2GE	REC841994	REC1397-2060
2.5L	1986	R2	2GC	REC823427A1	REC1397-2060
3.0L	1982-90	R2	2GC	REC823427A1	REC1397-2060
3.0L/HO	1991-92	H2	2300	REC21533394	
3.8L	1979-85	R2	2GE	REC841994	REC1397-3327
4.3L	1986-89	R2	2GE	REC841994	REC1397-2060
4.3L	1979-89	R4	4MV	REC823426A1	REC1397-3327
4.3/262	1989	R2	2GE	REC841994	REC1397-2060
4.3 HO	1990-92	H2	2300	REC3854020	
4.3HO	1990-92	H4	4160	REC986799	
5.0L (GM)	1979-85	R2	2GE	REC841994	REC1397-2060
5.0L (GM)	1979-89	R4	4MV	REC823426A1	REC1397-3327
5.0L (Ford)	1989	H2	2300	REC1396-4656	
5.0 HO	1989-90	H2	2300	REC986782	
5.0 HO	1989-90	H4	4160	REC986799	
5.0 HO	1991	H4	4160	REC1396-5238	
5.7L	1979-89	R4	4MV	REC823426A1	REC1397-3327
5.7LE	1991-92	H4	4175	REC987315	
5.8L	1989	H4		REC985052	
7.5L	1987-88	H4		REC985052	
305 C.I.I./B	1977-79	R2	2GE	REC841994	REC1397-2060
305 C.I.I./B	1977-78	R4	4MV	REC823426A1	REC1397-3327
305 C.I.I./B	1979-83	R4	4MV	REC823426A1	REC1397-3327
305 C.I.I./B	1979-83	R4	4MV	REC823426A1	REC1397-3327
350	1988-89	R4	4MV	REC823426A1	REC1397-3327
350	1988	R2	2GE	REC841994	REC1397-2060
454 C.I.I./B	1977-78	R4	4MV	REC823426A1	REC1397-3327
454 HO	1991-92	H4	4150	REC3854105	
460 C.I.	1987-88	H4	-	REC985052	

# SISTEMA ELÉCTRICO ELECTRIC SYSTEM

# SISTEMA ELETTRICO SYSTÈME ÉLECTRIQUE

## SENSORES

## SENSORS

## SENSORE

## CAPTEURS

### SENSOR PRESIÓN DE ACEITE

### OIL PRESSURE SENDER

### SENSORE PRESIONE OLIO

### SONDE PRESSION D'HUILE

REF	OEM
REC8M0068784	3857532



### SENSOR TEMPERATURA AGUA

### WATER TEMPERATURE SENDER

### SENSORE TEMPERATURA ACQUA

### SONDE TEMPERATURE DE L'EAU

REF	OEM
REC3854159	3854159

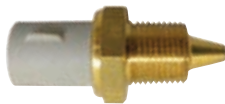

REF	OEM	Pressure
REC806490T	3853787	3/8" 18NPT



REF	OEM
REC35-03752	



REF	OEM	Pressure
REC97258A1	171960	1/2" 14NPT



### KIT TEMPERATURA Y PRESION DE ACEITE CON ALARMA

### COMPLETE TEMPERATURE & OIL PRESSURE WARNING KIT

### KIT TEMPERATURA E PRESSIONE DELL'OLIO CON ALLARME

### KIT SONDE TEMPERATURE ET PRESSION D'HUILE AVEC ALARME

REF	OEM
REC41400	



### SENSOR TPS

### TPS SENDER

### SENSORE TPS

### CAPTEUR TPS

REF	OEM
REC8M0125617	3855184



### VACUÓMETRO. MAP

### MAP SENSOR

### VACUOMETRO. MAP

### CAPTEUR MAP

REF	OEM
REC3850396	3850396



## MOTORES DE ARRANQUE

## STARTERS

## MOTORINI AVVIAMENTO

## DÉMARREUR

REF	OEM	⚡	☀️	
REC50-99417A2	982121 981078 988217	12V	9	4 en línea (Tornillos sujeción misma altura) Duty standard rotation 4 in line. In line mounting holes. 4 in linea (viti di supporto parallele) 4 en ligne (vis de fixation parallèles)



REF	OEM	⚡	☀️	🔑	
REC0984628	984628	12V	10		FORD 2.3L & 5.8L Con 3 tornillos de anclaje. 3 mounting holes. Con 3 viti di supporto Avec 3 vis de support



REF	OEM	⚡	☀️	🔑	
REC0984536	984536 988013	12V	10		OMC 460 COBRA



REF	OEM			
REC0987883	3854194			Solenoid Solenoid Solenoid Solenoid



REF	OEM	⚡	☀️	
REC50-97499A2	981289 982202	12V 1.4 kW	9	



REF	OEM	⚡	☀️	🔑	
REC50-808011A05	981288 984982	12V 1.4 kW	9		Contrarrotación o montaje en campana. Counter clockwise starter Controrotante montato nella campana. Contre rotation, installation dans une cloche.



REF	OEM	⚡	☀️	🔑	
RECRA122002		12V	10		Contrarrotación. Counter clockwise starter Controrotante. Contre rotation.



REF	OEM			
REC3854190	987811 3854190	12V	10	Ford 5.0L & 5.8L Con 2 tornillos de anclaje 2 mounting holes Con 2 viti di supporto Avec 2 vis de support



REF	OEM				
REC50-863007A1	3860566	12V 1.4 kW	11	14"	V6 & V8

REF	OEM
REC10-861788	10-861788



REF	OEM			
REC50-99418A2	3860566	12V	9	Tornillos sujeción en diagonal Offset mounting holes Con viti in diagonale Avec vis de support en diagonal

REF	OEM
MP0180-001	10-812509184
REC10-861788	10-861788



REF	OEM				
REC50-806965A4	988217	12V	11	12 <sup>3/4</sup> "	COBRA 3.0 L

REF	OEM
MP0180-001	10-812509184
REC10-861788	10-861788



REF	OEM			
REC3885317		12V	11	HEAVY DUTY. GM 454 7.4L Tornillos sujeción en diagonal Offset mounting holes Con viti in diagonale Avec vis de support en diagonal

REF	OEM
REC10-861788	10-861788



REGULADOR      REGULATOR      REGOLATORE      REGULATEUR

REF	OEM	
ARCVR-404	383440	PRESTOLITE





ALTERNADORES

ALTERNATORS

ALTERNATORI

ALTERNATEURS

ALTERNADORES

ALTERNATORS

ALTERNATORI

ALTERNATEUR

REF	OEM	⚡
REC0985964	985964	12V 63 A



REF	OEM	⚡
REC3860769	986008 985964	12V 55 A



REF	OEM	⚡
REC69729	988247	12V 63 A



SOLENOIDES Y RELÉS

SOLENOID & RELAY

SOLENOIDI E RELÉ

SOLENOID ET RELAIS

SOLENOIDE

SOLENOID

SOLENOIDI

SOLENOIDE

REF	OEM	
REC13037	1114356	DELCO REMY



REF	OEM
REC0979774	979774



REF	OEM
REC3853839	982187 985063



REF	OEM
REC0586180	383622 582708 345419 586180



RELÉ BOMBA DE GASOLINA ELECTRICA

RELAY FOR FUEL ELECTRIC PUMP

RELE POMPA BENZINA ELETTRICA

RELAIS POUR POMPE BENZINE ÉLECTRIQUE

REF	OEM
REC3857533	3857533



# TRIM

## MOTOR TRIM

## TRIM ENGINES

## MOTORI TRIM

## MOTEUR TRIM

REF	OEM	
REC0393988	393259	2
	393988	
	394176	
	391264	
	983019	
	985237	





REF	OEM	
REC382138	986280 3853945	2





REF	OEM	
REC0584107	387277 582048 582155	3



REF	OEM		
ARC6211	983318	3	2.5L, 3.0L (1979-85)



REF	OEM		
REC3853945	986280 3853945	2	COBRA (1987-93)



REF	OEM	
REC0982706	982058 982706	3



**LATIGUILLOS TRIM COBRA**

ESTRIBOR - BAJADA

REF	OEM
REC3853854	3853854

BABOR - BAJADA

REF	OEM
REC3853856	3853856

**TRIM HOSES COBRA**

STB - DOWN

PORT - DOWN

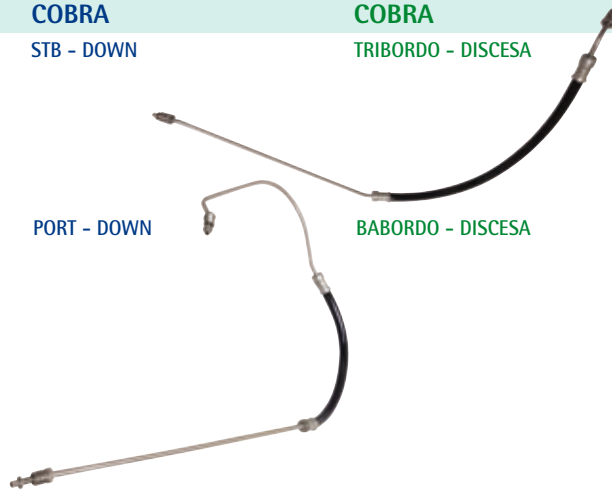

**TUBI TRIM COBRA**

TRIBORDO - DISCESA

BABORDO - DISCESA

**TUYAU TRIM COBRA**

TRIBORD - BAS

BABORD - BAS

ESTRIBOR - SUBIDA

REF	OEM
REC3853855	3853855

BABOR - SUBIDA

REF	OEM
REC3853857	3853857

STB - UP

PORT - UP

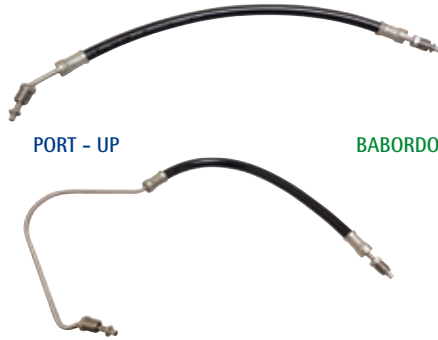

TRIBORDO - SALITA

BABORDO - SALITA

TRIBORD - HAUT

BABORD - HAUT

**SENSOR TRIM COBRA**

REF	OEM
RM3850470	3850470 0983939 0984731

**TRIM SENSOR COBRA**

**SENSORE TRIM COBRA**

**CAPTEUR TRIM COBRA**



new

# SISTEMA DE REFRIGERACIÓN COOLING SYSTEM

# SISTEMA DI RAFFREDDAMENTO SYSTÈME DE REFROIDISSEMENT

## TERMOSTATO

## THERMOSTAT

## TERMOSTATO

## THERMOSTAT

### KITS DE TERMOSTATO

### THERMOSTAT KITS

### KIT TERMOSTATI

### KITS DE THERMOSTAT

REF	OEM		
REC3853799	3853799	Chevys 4 cil. (1980+)	160 °C



REF	OEM		
REC3853983		7.4L (1994-97)	140°



3852111      3852071      3853983

REF	OEM	
REC13430		N000 Chevys 4 cyl. (1980+)





### GUIA TERMOSTATOS

### THERMOSTAT GUIDE

### GUIDA TERMOSTATI

### GUIDE THERMOSTAT

	TERMOSTATO THERMOSTAT TERMOSTATO THERMOSTAT	KIT
90	1970	REC13430
100	1972-73	REC13430
120	1969-80	REC13430
120	1980-81	REC3853799
140	1973-80	REC13430
140	1980-81	REC3853799
155	1969-72	REC13430
165	1972-76	REC13430
170	1974	REC13430
175	1975-77	REC13430
185	1978-80	REC13430
190	1974-77	REC13430
200	1979-81	REC13430
210	1969-72	REC13430
215	1971	REC13430
225	1971	REC13430
230	1979-81	REC13430
235	1971	REC13430

	TERMOSTATO THERMOSTAT TERMOSTATO THERMOSTAT	KIT
235	1975-77	REC13430
240	1978	REC13430
245	1972-75	REC13430
250	1970-73	REC13430
250	1979	REC13430
260	1979-81	REC13430
305	1977-82	REC13430
350	1977-82	REC13430
454	1977-82	REC13430
2.5L	1982-88	REC3853799
3.0L	1982-88	REC3853799
3.8L	1981-85	REC13430
4.3L	1985-86	REC13430
5.0L	1982-88	REC13430
5.7L	1982-88	REC13430
7.4L	1994-97	REC3853983
7.5L	1988	REC13430



**CUERPO DE TERMOSTATO THERMOSTATO HOUSING**

REF	OEM
BAOMC29-314810	314810 982201



REF	OEM
BAOMC29-910303	3854254



REF	OEM
BAOMC29-908216	908216



**CORPO TERMOSTATO**

REF	OEM
REC3850360	986292 987716 3850360



REF	OEM
HGE5470	985470 Ford 2.3L



**BOMBAS ASPIRACIÓN AGUA MARINA**

**RAW MARINE WATER PUMPS**

**POMPE ASPIRAZIONE ACQUA MARINA**

**POMPE À EAU MARINE**

**BOMBAS DE AGUA**

**WATER PUMPS**

**POMPE ACQUA**

**POMPEÀ EAU**

REF	OEM	
SHEG9901	3858847	4.3 & 8.2 (SX)

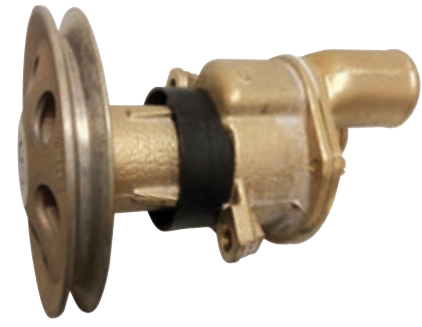

REF	OEM	
SHEG9903	3855079 3851982 3857794	3.0 L (SX)

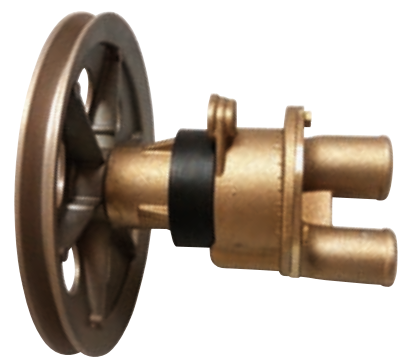

# SISTEMA ENCENDIDO IGNITION SYSTEM

# SISTEMA DI ACCENSIONE SYSTEME D'ALLUMAGE

## BOBINAS

## COILS

## BOBINE

## BOBINES

### BOBINA DE ENCENDIDO

### IGNITION COIL

### BOBINA DI ACCENSIONE

### BOBINE D'ALLUMAGE

REF	OEM
REC300-00879	3852217

No usa resistencia externa.  
Utilizar con encendido Prestolite.  
Use without external resistor & Prestolite ignition  
Non utilizza resistenza esterna.  
Utilizzare con spinterogeno Prestolite  
N'utilise pas de résistance externe.  
A utiliser avec l'allumage Prestolite.



REF	OEM	FORD
REC3854161	3854161	FORD



REF	OEM
REC1463-9382	3853548

Resistencia externa.  
Utilizar con encendido convencional.  
External resistor. Use with conventional ignition  
Resistenza esterna.  
Utilizzare con accensione convenzionale  
Résistance externe.  
A utiliser avec un allumage conventionnel.



REF	OEM	GM
REC3854002	3854002	GM



### GUÍA DE BOBINAS DE ENCENDIDO

### IGNITION COIL GUIDE

### GUIDA BOBINA DI ACCENSIONE

### GUIDE BOBINE D'ALLUMAGE

		REF
94-93	351 EFI King 5.0L, 5.8L EFI	REC3854161 REC3854161
94-90	3.0L, 3.0L H.O.	REC3854002
94-89	5.0L, 5.0L H.O., 5.8L 5.7L	REC1463-9382 REC1463-9382
94	7.4L	REC1463-9382
93-92	454, 454 H.O., 502	REC1463-9382
93	351 King	REC1463-9382
92-91	5.7L w/Electronic Ign.	REC1463-9382
92-90	5.7LE OMC Cobra (w/Conv. Ign.)	REC1463-9382
92	351	REC1463-9382
91-90	4.3L, 4.3L H.O. (2V Models)	REC1463-9382
90-87	2.3L	REC1463-9382
90	3.0L (PWC)	REC1463-9382
89-88	350 OMC King Cobra 460 OMC King Cobra	REC1463-9382 REC1463-9382
89-85	2.5L, 3.0L, 4.3L Eng.	REC1463-9382
88-86	5.0L, 5.7L	REC1463-9382
88	370 OMC King Cobra	REC1463-9382

		REF
87	335 OMC Cobra 340 OMC King Cobra 7.5L	REC1463-9382 REC1463-9382 REC1463-9382
84-80	120, 140, 185, 200, 230, 260 HP	REC1463-9382
79	120, 140, 185, 200, 230, 250, 260 HP	REC1463-9382
78	120, 140, 185, 225, 230, 240, 305, 350, 454HP	REC1463-9382
77	120, 140, 175, 190, 225, 230, 235 HP	REC1463-9382
76	120, 140, 165, 175, 190, 225, 230, 235 HP	REC1463-9382
75	120, 140, 165, 175, 190, 225, 230, 235, 245,	REC1463-9382
74	120, 140, 165, 225, 245, 250, 290 HP	REC1463-9382
73	100, 120, 140, 165, 225, 245, 250 HP	REC1463-9382
72	100, 120, 155, 165, 210, 225, 245, 250 HP	REC1463-9382
71	90, 120, 155, 210, 215, 235, 250 HP	REC1463-9382

**BUJÍAS**

**SPARK PLUG**

**CANDELE**



**BOUGIES**

**BUJÍAS**

**SPARK**

**CANDELE**

**BOUGIES**

							
1990-87	2.3L Cobra	CHARS12YC	NGKTR5	1993	5.0L Cobra EFI	CHARV15YC4	NGKUR4
1996	3.0L SX Cobra	CHARS12YC	NGKTR5	1996	5.7L SX Cobra	CHARV15YC4	NGKUR4
1995-90	3.0L Cobra HO	CHARS12YC	NGKTR5	1992-86	5.7L King Cobra	CHARV15YC4	NGKUR4
1994-93	3.0L Cobra	CHARS12YC	NGKTR5	1996 (Carb.)	5.8L SX Cobra	CHARV15YC4	NGKUR4
1992-87	3.0L Cobra	CHARV15YC4	NGKUR4	1996 (EFI)	5.8L SX Cobra	CHARS9YC	NGKTR5
1996 (.460*)	4.3L SX Cobra	CHARV15YC4	NGKUR4	1995-89 (Carb.)	5.8L Cobra	CHARV15YC4	NGKUR4
1996 (.708*)	4.3L SX Cobra	CHARS12YC	NGKTR5	1995-92 (EFI)	5.8L Cobra	CHARS9YC	NGKTR5
1995-86	4.3L Cobra	CHARV15YC4	NGKUR4	1995-93 (EFI-HO)	5.8L King Cobra	CHARS9YC	NGKTR5
1991-90	4.3L Cobra HO	CHARV15YC4	NGKUR4	1996	7.4L SX Cobra	CHARV15YC4	NGKUR4
1994-93	4.3L Cobra HO	CHARV15YC4	NGKUR4	1995-90 (Carb.)	7.4L SX Cobra	CHARV15YC4	NGKUR4
1996 (Carb.)	5.0L SX Cobra	CHARV15YC4	NGKUR4	1995 (EFI)	7.4L King Cobra	CHARV15YC4	NGKUR4
1996 (EFI)	5.0L SX Cobra	CHARS12YC	NGKTR5	1993-91 (Carb.)	7.4L Cobra HO	CHARV15YC4	NGKUR4
1995-96 (Carb.)	5.0L Cobra	CHARV15YC4	NGKUR4	1990-86	7.5L Cobra	CHARV15YC4	NGKUR4
1995-89 (Carb.)	5.0L Cobra HO	CHARV15YC4	NGKUR4	1996	8.2L SX Cobra	CHARV15YC4	NGKUR4
1995-94	5.0L Cobra EFI	CHARS12YC	NGKTR5	1994-92	8.2L King Cobra	CHARV15YC4	NGKUR4

**JUEGOS DE CABLES, ALTO RENDIMIENTO**

**HD SPARK PLUG WIRE SET**

**KIT CAVI CANDELE, ALTE PRESTAZIONI**

**KIT FAISCEAU DE BOUGIE**

Núcleo del cable de Kevlar de 8 mm antimagnético. Funda de silicona amarilla. Terminales bujías con muelle de acero inox. Terminal del distribuidor de cobre. Terminales bobina. Silicona resistente a altas temperaturas. Garantía de 5 años.

Antimagnetic. Kevlar core. Yellow silicone boot & jacket. SS snaplock. Brass distributor terminal. Coil terminals. High resistant silicone. 5 year warranty.

Nucleo del cavo di Kevlar da 8 mm antimagnetico. Copertura di silicone gialla. Terminali candele con molle di acciaio inox. Terminale lato spinterogeno in rame. Terminale Bobine. Silicone resistente alle alte temperature. Garanzia di 5 anni.

Noyau en Kevlar antimagnétique. Gaine en silicone jaune. Bornes de bougie d'allumage avec ressort en acier inoxydable. Terminal de distribution en laiton. Bornes de bobine. Silicone haute résistance. Garantie de 5 ans.

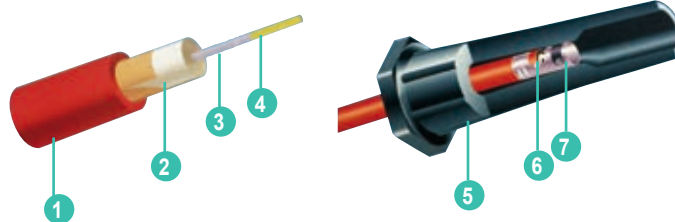

	HD SPARK PLUG WIRE SET	KIT CAVI CANDELE, ALTE PRESTAZIONI	KIT FAISCEAU DE BOUGIE	
1	Camisa de silicona de 8 mm	8 mm silicone jacket	Rivestimento in silicone da 8 mm	Gaine silicone de 8mm
2	Látex resistente altas temperaturas	Heat resistant latex	Latex resistente alle alte temperature	Latex résistant à haute température
3	Acero inox	Stainless Steel	Acciaio inox	Acier inox
4	Núcleo de Kevlar	Kevlar core	Nucleo de Kevlar	Noyau de Kevlar
5	Capuchón de silicona	Silicone jacket	Rivestimento in silicone	Capuchon en silicone
6	Trenzado especial fibra de vidrio	Fiberglass braiding	Fibra di vetro	Tresse en fibre de verre
7	Terminal de acero inox	Stainless Steel terminal	Terminale di acciaio inox	Terminal en acier inox

	ARRANQUE IGNITION AVVIAMENTO DEMARRAGE				
	CYL	CONVEN.	ELECT.	REF	OEM
110 / 120 / 2.5L / 140 / 3.0L / 140 JET	4	✓		REC15-401	
3.0L / HO	4		✓	REC15-405	503748
185 (6 en línea   in line   in rete   en ligne)	6	✓		REC15-602	503748
3.8 L / 4.3 L (229, 262) V6	6	✓		REC15-604	
4.3L (262) V6	6		✓	REC15-601	503750
175 / 185 / 190 / 20 / 5.0 L - 5.7 L / (GM) (Mallory)	8	✓		REC15-801	503751
				REC15-806	503752
5.0 L - 5.8 L (FORD)	8	✓		REC15-806	503755
				REC15-805	503753
5.0 L - 5.8 L - EFI (FORD)	8		✓	REC15-801	503754
				REC15-806	503752
225 / 230 / 235 / 240 / 250 / 260 (Mallory)	8	✓		REC15-801	503755
				REC15-806	503752
370 KING / 454 / 7.4 L / 502 / 8.2 L	8	✓		REC15-801	503755
				REC15-806	503752
460 KING	8	✓		REC15-811	503755

MÓDULOS IGNICIÓN

IGNITION MODULES

MODULI AVVIAMENTO

MODULES D'ALLUMAGE

REF	OEM
REC3854001	3854001 986642

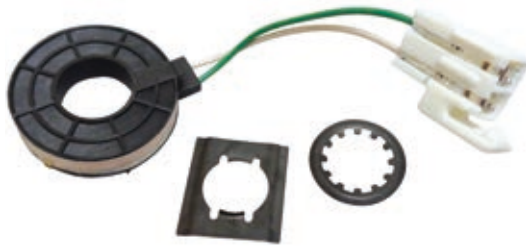

REF	OEM	Icon
REC3854003	3854003 986650	4L, V8



DISTRIBUIDOR

DISTRIBUTOR

SPINTEROGENO

ALLUMEUR

REF	OEM	Icon
REC195141	GM 4 CIL.	



REF	OEM	Icon
REC392-6316	FORD 302 CID V8	



REF	OEM	Icon
REC17177A1	17177A1	GM V8



REF	OEM	Icon
REC392-6330	985764	FORD 351 CID V8

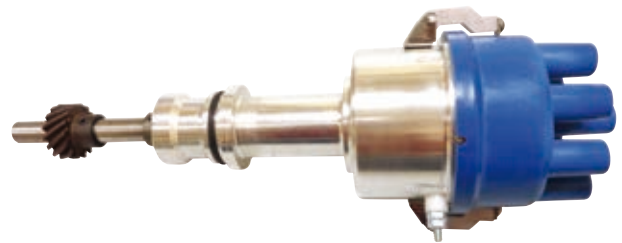

TAPA DISTRIBUIDOR

DISTRIBUTOR CAPS

CALOTTE SPINTEROGENO

TÊTE D'ALLUMEUR

REF	OEM	Icon
REC393-9459Q1	380541	4 Cyl



REF	OEM	Icon
REC33765T	980152	6 CYL



REF	OEM	Icon
REC12532	382133	MALLORY V8



REF	OEM	Icon
REC3854217	3854217	V8 EFI





REF	OEM	
REC33708	383587	V8





REF	OEM	
REC982209	982209	MALLORY V8



REF	OEM	
REC392-9086T	3853814	PRESTOLITE V6



REF	OEM	
REC835702	982336	PRESTOLITE V8 Clip



REF	OEM	
REC392-9766	3853815	PRESTOLITE V8 Con tornillo Screw on Con vite Avec vis



REF	OEM	
REC985218	985218	MALLORY 4 cyl



REF	OEM	
REC3854260	3854260	4 cyl



**TAPA DISTRIBUIDOR, ENCENDIDO ELECTRONICO**    **DISTRIBUTOR CAPS ELECTRONIC IGNITION**    **CALOTTE SPINTEROGENO ACCESIONE ELETTRONICO**    **TÊTE D'ALLUMEUR ALLUMEUR ÉLECTRIQUE**

REF	OEM	
REC3854331	3854331	DELCO V6



REF	OEM	
REC3854548	3854548	DELCO V8





**CONDENSADORES**    **CONDENSERS**    **CONDENSATORI**    **CONDENSATEUR**

REF	OEM	
REC8M6001249	987895	PRESTOLITE V6 & V8



REF	OEM	
REC8M6001217	382136 382125	MALLORY & DELCO V8



REF	OEM	
REC33662	380537	DELCO 4 & 6 CIL.





ROTORES

ROTORS

ROTORI

DOIGT D'ALLUMEUR

REF	OEM		
REC3853801	3853801	PRESTOLITE V6 et V8	

REF	OEM		
REC3854261	3854261	DELCO 4 cyl	

REF	OEM		
REC834975	980892	PRESTOLITE V8 Clip	

REF	OEM		
REC3854549		DELCO V6	

REF	OEM		
REC89825302	982211	MALLORY V8	

REF	OEM		
REC58217	384735	DELCO 4 et 6 cyl	

REF	OEM		
REC841243	982342	MALLORY V8 Plano   Flat   piatto   plane	

REF	OEM		
REC3854311		DELCO V8 Encendido electrónico   Electronic ignition Accessione elettronico   Allumage électronique	

PLATINOS



POINTS



PUNTINE

VIS PLATINEES

REF	OEM		
REC34235T	380538	DELCO 4 et 6 cyl	

REF	OEM		
REC391-5090	382135	MALLORY V8	

REF	OEM		
REC33700	380543	DELCO V8	

REF	OEM		
REC8M6001219	980893 987136 987894	PRESTOLITE V6 et V8	

KITS DE ENCENDIDO

TUNE UP KITS

KIT D'ACCENSIONE

KITS D'ALLUMAGE

REF	OEM	
REC801766		

REF	OEM	
REC3423A1		

REC58217 + REC34235T + REC33662



### KITS DE CONVERSIÓN ELECTRÓNICO

Sustituyen condensadores y contactos por componentes electrónicos. Usa bobina, tapa y rotor estándar. Fácil instalación, una pieza y dos cables. Precisión entre 1/4" calibrado de 0 a 8000 rpm.

### ELECTRONIC CONVERSION KITS

To substitute condensers for electronic devices. Uses standard coil, cap & rotor. Easy installation; one piece, two cables. Precisely calibrated between 1/4" from 0 to 8000.

### KIT DI CONVERSIONE ELETTRICO

Sostituiscie condensatori e contatti per componenti elettronici. Utilizza bobina, calotta e rotore standard. Facile installazione, una pz e due cavi. Precisione 1/4" calibrato da 0 a 8000.

### KITS DE CONVERSION ÉLECTRONIQUE

Remplace les condensateurs et les contacts par des composants électroniques. Utilise une bobine, un couvercle et un rotor standard. Installation facile, une seule pièce et deux fils. Précision de 1/4" calibrée de 0 à 8000 rpm.

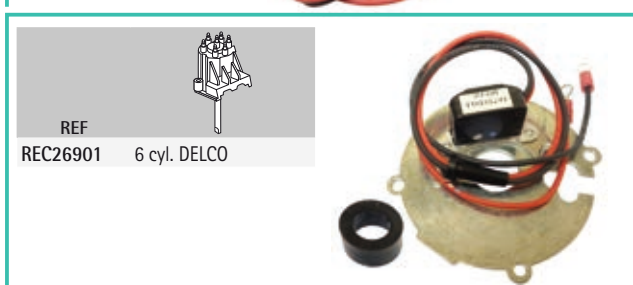

### MÓDULO SISTEMA CAMBIO

### SHIFT ASSIST MODULE

### MODULO SISTEMA CAMBIO

### MODULE, SYSTÈME DE CHANGEMENT

REF	OEM	CYL
REC987739	982755	4
	984281	
	985902	
	982774	
	984036	6
	986342	
	987740	
	982749	
	984276	8
	984730	
	986837	
	987738	
	987739	



# PARTES DEL MOTOR ENGINE PARTS

# PARTI MOTORE PIECES MOTEUR

## JUNTAS PARA BASES GM Y FORD

Los Kits están diseñados y catalogados específicamente para aplicaciones marinas. Su calidad es superior a las juntas originales.

## MARINE GASKETS TO GM & FORD ENGINES

The gaskets kits are designed and cataloged specifically for marine engine applications. Their quality is even better than the oem's.

## GUARNIZIONI PER MOTORI GM E FORD

I kit di guarnizioni sono disegnati e fabbricati specificatamente per applicazioni marine. La qualità è assolutamente paragonabile a quelle originali.

## JOINTS POUR MOTEURS GM ET FORD

Les kits sont spécifiquement conçus et catalogués pour les applications marines. Leur qualité est supérieure à celle des joints d'origine.

SERIE SERIAL				
1700-17099	KIT JUNTAS DE CULATA (pack individual)	CYLINDER HEAD GASKET (single-packed)	GUARNIZIONI TESTATA (quantità 1)	KIT JOINTS DE CULASSE (paquet individuel)
17100-17199	JUEGOS DE CONVERSIÓN Todas las juntas y retenes de aceite que no se encuentran en los juegos de culata. Incluye las juntas del cárter y los retenes.	CONVERSION KITS All gaskets and oil seals not found in a Head Set. This includes timing cover gaskets and seals, oil pan gaskets, and rear main bearing seals.	KIT PARTE BASSA Include tutte le guarnizioni ed i paraoli della parte bassa del motore, viene fornita anche la guarnizione della coppa dell'olio.	KITS DE CONVERSION Tous les joints d'étanchéité et joints d'huile qui ne sont pas contenus dans les kits de culasse. Comprend les joints de carter et les joints d'huile.
17200-17299	KIT DE DESCARBONIZACIÓN Todas las juntas y retenes necesarios para el trabajo de las válvulas, incluyendo la culata, la tapa de la válvula y juntas de colector de admisión y colector de escape. (Los juegos de 4 cyl no contienen las juntas del colector de admisión/escape. Deben pedirse por separado).	HEAD SETS SERIES All gaskets and seals necessary for a valve grinding job, including cylinder head gaskets, valve cover gaskets, intake & exhaust manifold gaskets (except 4 cyl intake set), and valve stem seals.	KIT PARTE ALTA (SMERIGLIO) Include tutte le guarnizioni ed i paraoli della parte alta del motore, testate, carter distribuzione, aspirazione e scarico. (Motori a 4 cyl. la guarnizione aspirazione è da ordinare separatamente).	KIT DE DÉCARBONISATION Tous les joints requis pour le travail sur les soupapes, y compris les joints de culasse, de couvercle de soupape, de collecteur d'admission et d'échappement (les kits 4 cylindres ne contiennent pas de joints de collecteur d'admission/échappement). Ils doivent être commandés séparément.
17300-17399	KIT DE COLECTOR DE ADMISIÓN Juntas de la parte de admisión del colector, retenes y juntas de la base del distribuidor.	INTAKE MANIFOLD SETS Intake manifold side gaskets, intake manifold end seals, and distributor mounting gasket.	KIT GUARNIZIONE ASPIRAZIONE Guarnizioni laterali del collettore di aspirazione, guarnizioni e guarnizioni della base del distributore.	KIT DE COLECTEUR D'ADMISSION Joints de collecteur d'admission, joints d'étanchéité et joints de base de distributeur.
17400-17499	KIT DE COLECTOR DE ESCAPE (de colector a culata)	EXHAUST MANIFOLD (manifold-to-cylinder head gaskets)	KIT GUARNIZIONE SCARICO (dalla testata al collettore)	KIT COLLECTEUR D'ÉCHAPPEMENT (collecteur à la culasse)
17700-17749	KIT DE CONTRARROTACIÓN RETÉN TRASERO DEL CIGÜENAL Retenes traseros del cigüeñal diseñados para motores de rotación opuesta a la normal. (Retenes de rotación normal incluidos en el set de conversión)	REVERSE ROTATION REAR MAIN BEARING SEAL SETS Rear main bearing seals designed to seal a crankshaft which rotates in the opposite direction from normal (Standard rotation seal is included in conversion set)	PARAOLIO MOTORI CONTROROTANTI ALBERO MOTORE Nei motori rotazione STD il paraolio viene già incluso nel kit della parte bassa. (Guarnizioni a rotazione normale incluse nel set di conversione)	KIT CONTRE-ROTATION JOINTS D'HUILE DE VILEBREQUIN ARRIÈRE Joints de vilebrequin arrière conçus pour les moteurs à contre-rotation (joints à rotation normale inclus dans le kit de conversion).
17750-17799	KIT DE RETENES TAPA DEL CIGÜENAL DE CONTRARROTACIÓN Retenes de la tapa del cigüeñal diseñados para motores de rotación opuesta a la normal. (Retenes de rotación normal incluidos en el set de conversión).	REVERSE ROTATION TIMING COVER SEAL SETS SERIES Timing cover seals designed to seal crankshaft which rotates in the opposite direction from normal (standard rotation seal is included in Conversion set and Timing cover set)	PARAOLIO CARTER DISTRIBUZIONE CONTROTOTANTI Guarnizioni del coperchio dell'albero a gomiti progettate per motori controrotanti (le guarnizioni per la rotazione normale sono incluse nel set di conversione).	KIT DE JOINTS DE COUVERCLE DE VILEBREQUIN CONTRE-ROTATIF Joints de couvercle de vilebrequin conçus pour les moteurs à contre-rotation (joints à rotation normale inclus dans le kit de conversion).
17900-17949	KIT DE TAPA VÁLVULA Todas las juntas de las tapas de las válvulas para sellar el motor.	VALVE COVER SET SERIES All valve cover or push rod cover gaskets (and grommets if required) required to seal one engine.	KIT COPERCHIO PUNTERIE Tutte le guarnizioni del coperchio della valvola per sigillare il motore.	KIT DE COUVERCLE DE SOUPAPE Tous les joints de couvercle de soupape pour l'étanchéité du moteur.
17950-17999	KIT DE CÁRTER Todas las juntas y retenes del cárter de aceite, o la junta del cárter de aceite de goma moldeada de una pieza, necesarias para sellar un motor.	OIL PAN SETS SERIES All oil pan gaskets & seals, or one-piece molded rubber oil pan gasket, required to seal one engine.	GUARNIZIONE COPPA DELL'OLIO Tutte le guarnizioni e le tenute della coppa dell'olio, o la guarnizione in gomma stampata in un unico pezzo, necessarie per sigillare un motore.	KIT DE CARTER D'HUILE Tous les joints de carter d'huile, ou un joint de carter d'huile en caoutchouc moulé d'une seule pièce, nécessaires à l'étanchéité d'un moteur.











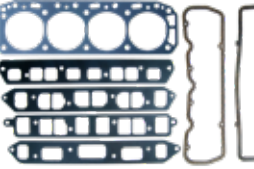

## 2.5L (100HP, 110HP, 120HP)







	REF	OEM	CULATA	CYLINDER HEAD	TESTATA	CULASSE
	REC17000	3853336 908611	JUNTA CULATA	CYLINDER HEAD	GUARNIZIONE TESTATA	JOINT DE CULASSE
	REC17200		KIT JUNTAS SUPERIOR	GASKET HEAD SET	KIT PARTE ALTA	KIT DE JOINTS SUPÉRIEURS
	REF		INFERIOR	CONVERSION	PORTE BASSA	PARTIE BASSE
	REC17100		Retén 2 piezas, 4 piezas junta cárter.	2 piece rear main bearing seal & 4 piece oil pan gasket	Paraolio in 2 px, 4 pz guarnizione coppa dell'olio.	Joint d'huile 2 pièces, joint de carter 4 pièces.

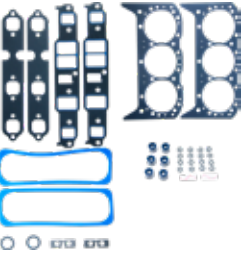
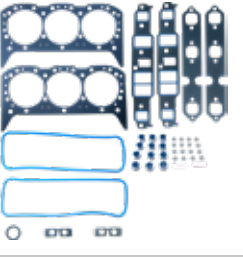
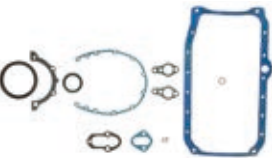

	REF	COLECTOR ADMISION-ESCAPE	MANIFOLD INTAKE & EXHAUST	COLLETTORE ASPIRAZIONE-SCARICO	COLLECTEUR ADMISION ET ÉCHAPPEMENT
	REC27-96429	COBRA	COBRA	COBRA	COBRA
	REC27-815528	3853256  COBRA	 COBRA	 COBRA	 COBRA
	REF	CARTER	OIL PAN	COPPA DELL'OLIO	CARTER
	REC17950	3853343 KIT JUNTAS CARTER Retén trasero dos piezas, 4 piezas junta cárter.	GASKET OIL PAN SET Two piece rear main bearing seal & 4 piece oil pan gasket	KIT GUARNIZIONE Paraolio posteriore in 2, guarnizione coppa in 4 pz.	KIT DE JOINTS CARTER Joint arrière en deux parties, Joint de carter 4 pièces.
	REF	TAPA VÁLVULAS	VALVE COVER	COPERCHIO VALVOLE	COUVERCLE
	REC17900	3852693 Junta	Gasket	Guarnizione	Joint
	REF	TAPA EMPUJADORES	PUSH ROD COVER	COPERCHIO ASTE PUNTERIE	COUVERCLE
	REC17903	3856443 Junta	Gasket	Guarnizione	Joint



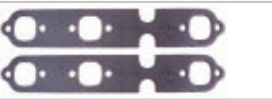



### 3.0L (115 HP), 3.0L HIGH OUTPUT (130 HP), 130/3.0L (130 HP), 140/3.0L (140 HP)

	REF	OEM	CULATA	CYLINDER HEAD	TESTATA	CULASSE
	REC17000	3853336 908611	JUNTA CULATA	CYLINDER HEAD	GUARNIZIONE TESTATA	JOINT DE CULASSE
	REC17200		KIT JUNTAS SUPERIOR	GASKET HEAD SET	KIT PARTE ALTA	KIT DE JOINTS SUPÉRIEURS
	REF	OEM	INFERIOR	CONVERSION	PARTE BASSA	PARTIE BASSE
	REC17102		KIT JUNTAS Retén 1 pieza. Junta cárter 1 pieza.	GASKET SET 1 piece rear main bearing seal 1 piece oil pan gasket	KIT Paraolio in 1 pz. Guarnizione coppa dell'olio in 1 pz.	KIT JOINTS INFERIEURS Joint spi 1 pièce. Joint de carter 1 pièce.
	REC17100		Retén 2 piezas, 4 piezas junta cárter.	2 piece rear main bearing seal & 4 piece oil pan gasket	Paraolio in 2 px, 4 pz guarnizione coppa dell'olio.	Joint d'huile 2 pcs, 4 pièces de joint de carter.
	REF	COLECTOR ADMISION-ESCAPE	MANIFOLD INTAKE & EXHAUST	COLLETTORE ASPIRAZIONE-SCARICO	COLLECTEUR ADMISION ET ÉCHAPPEMENT	
	REC27-96429	COBRA con tapa de colector desmontable.	COBRA with removable end cap.	COBRA con coperchio collettore smontabile	COBRA avec couvercle de collecteur détachable	
	REC27-815528	COBRA sólo H.O. Colector de una pieza	COBRA, H.O. only with 1 piece manifold.	COBRA solo H.O. collettore in 1 pz.	COBRA H.O. Collecteur de 1 pièce.	
	REC27-53354	 COBRA.	 COBRA.	 COBRA	 COBRA	
	REF	CARTER	OIL PAN	COPPA DELL'OLIO	CARTER	
	REC17950	KIT JUNTAS Retén trasero dos piezas, 4 piezas junta cárter.	GASKET SET Two piece rear main bearing seal & 4 piece oil pan gasket	KIT GUARNIZIONE Paraolio posteriore in 2, guarnizione coppa in 4 pz.	KIT DE JOINTS Joint arrière en deux parties, Joint de carter 4 pièces.	
	REF	TAPA VÁLVULAS	VALVE COVER	COPERCHIO VALVOLE	COUVERCLE SOUPAPES	
	REC17900	3852693 Junta	Gasket	Guarnizione	Joint	
	REF	TAPA EMPUJADORES	PUSH ROD COVER	COPERCHIO ASTE PUNTERIE	COUVERCLE	
	REC17903	3856443 Junta	Gasket	Guarnizione	Joint	

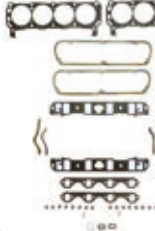
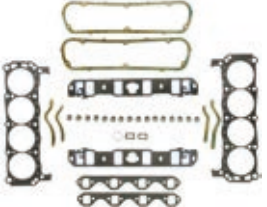
4.3L (150, 160, 175, 180 Et 205 HP)						
	REF	CULATA	CYLINDER HEAD	TESTATA	CULASSE	
	REC17010	3854299	Se necesitan dos	2 required	Necessarie 2	Deux sont nécessaires
	REC17210		Motor sin eje equilibrado. Incluye juntas tapa válvulas y retenes.	Engine without balance shaft; valve cover gskts and premium valve stem seals incl.	Motore senza asse bilanciato. Include guarnizione coperchio punterie e paraoli valvole.	Moteur sans arbre équilibré. Comprend les joints de couvre-soupapes et les joints d'étanchéité.
	REC17211		Motor con eje equilibrado. Incluye juntas tapa válvulas y retenes.	Engine with balance shaft; valve cover gskts and premium valve stem seals incl.	Motore con asse bilanciato. Include guarnizione coperchio punterie e paraoli valvole.	Moteur avec arbre équilibré. Comprend les joints de couvre-soupapes et les joints d'étanchéité.
	REF	INFERIOR	CONVERSION	PARTE BASSA	PARTIE BASSE	
	REC17115		Motor sin eje equilibrado con retén de una pieza y 1 pieza junta cárter. Incluye Junta de cárter.	Engine without balance shaft with one-piece rear main bearing seal & 1 piece oil pan gasket; oil pan gasket incl.	Motore senza asse bilanciato. Paraolio post in 1 pz e guarnizione coppa in 1 pz. Include la guarnizione del carter.	Moteur équilibré sans arbre, avec joint d'huile en une pièce et joint de carter en une pièce, y compris le joint de carter.
	REC17110		Motor sin eje equilibrado con retén de 2 piezas y 4 piezas junta cárter. Incluye Junta de cárter.	Engine without balance shaft with 2 piece rear main bearing seal & 4 pieces oil pan gasket; oil pan gasket incl.	Motore senza asse bilanciato. Paraolio post in 2 pz e guarnizione coppa in 4 pz. Include la guarnizione del carter.	Moteur équilibré sans arbre avec joint d'huile 2 pièces et joint de carter 4 pièces. Comprend un joint de carter.
	REC17116		Retén de 1 pieza.	1 piece rear gasket.	Paraolio posteriore in 1 pz	joint spi 1 pièce
	REF	COLECTOR ADMISION-ESCAPE	MANIFOLD INTAKE & EXHAUST	COLLETTORE ASPIRAZIONE-SCARICO	COLLECTEUR ADMISION ET ÉCHAPPEMENT	
	REC17310	857177	Junta Admisión-Escape	Intake-Exhaust Gasket	Guarnizione aspirazione-scarico	Joint admission et échappement
	REC27-99757	3853412	Kit juntas colector - escape	Exhaust gasket set	Kit guarnizione scarico	Kit joints collecteur d'échappement
	REF	CARTER	OIL PAN	COPPA DELL'OLIO	CARTER	
	REC17970		KIT JUNTAS CARTER 4 piezas junta cárter. (Retén 2 piezas)	GASKET OIL PAN SET 4 piece oil pan gasket (2 piece Seal)	KIT GUARNIZIONE Guarnizione coppa in 4 pz. (paraolio 2 pz)	KIT JOINTS 4 pièces carter.
	REC17971	3852655	1 junta carter (Retén 1 pieza)	1 piece oil pan gasket (1 piece seal)	Guarnizione coppa in 1 pz (paraolio 1 pz)	1 joint carter (Joint d'huile 1 pièce)

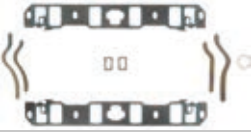



	REF	TAPA VÁLVULAS	VALVE COVER	COPERCHIO VALVOLE	COUVERCLE SOUPAPES
	REC17920 3854300	Motor sin eje equilibrado.	Engine without balance shaft	Motore senza asse equilibrato.	Moteur sans arbre équilibré.
	REC17921 3854942	Motor con eje equilibrado.	Engine with balance shaft	Motore con asse equilibrato.	Moteur avec arbre équilibré

**5.0L (160, 170, 185 HP), 5.0L HIGH OUTPUT (175, 190, 200 HP), 175 (175 HP), 190 (190 HP)**



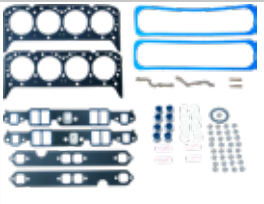
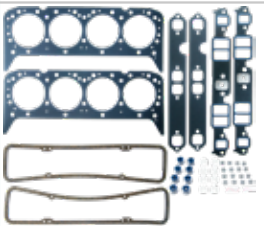

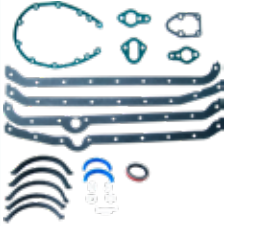

	REF	CULATA	CYLINDER HEAD	TESTATA	CULASSE
	FEL17060	Se necesitan dos	2 required	Necessarie 2	Deux sont nécessaires
	FEL17261	Con tapa válvulas de aluminio. Incluye retenes de válvulas.	With cast aluminum valve covers. Premium valve stem seals included.	Con coperchio punterie in alluminio. Include paraolio valvole.	Avec le cache culbuteur en Aluminium. Comprend les joints de queue de soupape.
	FEL17260	Incluye retenes de válvulas.	Premium valve stem seals included.	Include paraoli valvole.	Comprend les joints de queue de soupape.
	REF	INFERIOR	CONVERSION	PARTE BASSA	PARTIE BASSE
	FEL17161	Retén 1 piezas, 1 pieza junta cárter. Incluye junta de cárter.	1 piece rear main bearing seal & 1 piece oil pan gasket. Rubber oil pan gasket included.	Paraolio in 1 pz, 1 pz guarnizione coppa dell'olio. Include guarnizione coppa.	Joint spi 1 pièce Joint de carter 1 pièce. Comprend le joint de carter.
	FEL17160	Retén 2 piezas, 4 piezas junta cárter.	2 piece rear main bearing seal & 4 piece oil pan gasket.	Paraolio in 2 pz, 4 pz guarnizione coppa dell'olio.	Joint spi 2 pièces Joint de carter 4 pièces.
	REF	COLECTOR ADMISIÓN-ESCAPE	MANIFOLD INTAKE & EXHAUST	COLLETTORE ASPIRAZIONE-SCARICO	COLLECTEUR ADMISION ET ÉCHAPPEMENT
	FEL17360	Kit junta admisión	Intake gasket set	Kit guarnizioni aspirazione	Kit joints d'admission
	REC3852455	Junta escape	Exhaust gasket	Guarnizione scarico	Joints collecteur d'échappement
	REF	CARTER	OIL PAN	COPPA DELL'OLIO	CARTER
	FEL17995	Retén 2 piezas	2 pieces seal	Paraolio 2 pz	Joint spi 2 pièces
	FEL17997	1 pieza junta de goma.	1 piece oil pan gasket	Guarnizione 1 pz	1 Joint de carter de caoutchouc.
	REF	RETÉN TRASERO CIGÜEÑAL	CRANKSHAFT REAR SEAL	PARAOLIO POSTERIORE ALBERO MOTORE	JOINT ARRIÈRE DE VILEBREQUIN
	FEL17746	Retén partido Contrarrotación, goma; 2 piezas	Split seal Rev. rotation, rubber; 2 piece	Controrotazione in 2 pz.	Joint fendu contre-rotatif, caoutchouc ; 2 pcs.

REF	TAPA VÁLVULAS	VALVE COVER	COPERCHIO VALVOLE	COUVERCLE SOUPAPES
 FEL17945	Con tapa de válvulas de acero	With iron valve cover	Con coperchio valvole in acciaio	Cache culbuteur en acier
 FEL17946	Con tapa válvulas de aluminio.	With cast aluminium valve covers.	Con coperchio valvole in alluminio.	Cache culbuteur en Aluminium
REF	RETÉN DISTRIBUCIÓN	OIL SEAL TIMING COVER	PARAOLIO DISTRIBUZIONE	JOINT D'HUILE DE DISTRIBUTION
 REC3853341	Retén contrarrotación tapa distribución	Rev. rotation timing cover seal	paraolio contrarotazione	Joint contre-rotation couvercle distribution

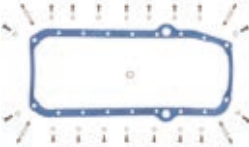

5.0L V8 (185, 200, 225, 230 HP)





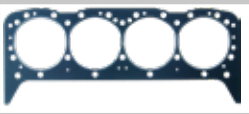
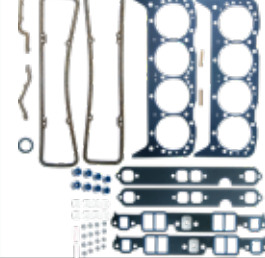

REF	CULATA	CYLINDER HEAD	TESTATA	CULASSE
 REC17020	3853380 Se necesitan dos	2 required	Ne servono 2	2 sont nécessaires
 REC17224	Tornillo centro tapa válvulas. Incluye retenes válvulas.	With center bolt desing valve covers. Premium valve stem seals included.	Viti coperchio punterie al centro. Include paraoli valvole.	Cache culbuteur avec les vis centrales. Comprend les joints de queue de soupapes.
 REC17220	Tornillo en el lateral tapa válvulas. Incluye retenes válvulas.	Rim bolt desing valve covers. Premium valve stem seals included.	Viti coperchio punterie nel perimetro. Include paraoli valvole.	Cache culbuteur avec les vis laterales. Comprend les joints de queue de soupapes.
REF	INFERIOR	CONVERSION	PARTE BASSA	PARTIE BASSE
 REC17125	Retén de 1 pieza y junta cárter de 1 pieza Incluye junta de cárter.	One-piece rear main bearing seal & 1 piece oil pan gasket. Oil pan gasket included.	Paraolio in 1 peze e guarnizione coppa in 1 peze. Include paraolio coppa.	Joint spi 1 pièce. Joint de carter 1 pièce. Comprend le Joint spi.
 REC17120	Retén de 2 piezas y junta cárter de 4 piezas	Two-piece rear main bearing seal & 4 pieces oil pan gasket.	Paraolio in 2 peze e guarnizione coppa in 4 pezi.	Joint spi 2 pièces et joint de carter 4 pièces.
REF	COLECTOR ADMISION-ESCAPE	MANIFOLD INTAKE & EXHAUST	COLLETORE ASPIRAZIONE-SCARICO	COLLECTEUR ADMISSION ET ECHAPPEMENT
 REC17320	856365 Kit Juntas Admisión-Escape	Intake-Exhaust Gasket Set	Kit guarnizioni aspirazione - SCARICO	Kit joints d'admission
 REC27-33395	856034 Kit juntas colector escape	Oil pan - exhaust gasket set.	Kit guarnizione Coppa olio - scarico.	Kit joints collecteur d'échappement.

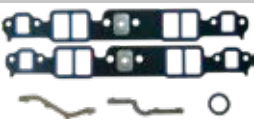

	REF	CARTER	OIL PAN	COPPA DELL'OLIO	CARTER	
	REC17982	3856138	Junta cárter 1 pieza. Junta de cárter incluida.	1 piece oil pan gasket. Molded rubber oil pan gasket included.	Guarnizione in 1 pz. Guarnizione coppa included.	Joint de carter 1 pièce.
	FEL17983		Junta 1 pieza. Para motores con retén trasero de 2 piezas.	1 piece molded rubber gasket for engines with Two-piece rear main bearing sea.	Guarnizione in 1 pz, paraolio posteriore in 2 px.	Joint de carter 1 pièce pour moteurs avec Joint spi arrière 2 pièces.
	REC17980	855729	Varilla aceite de BABOR con retén trasero de 2 piezas y junta cárter de 4 piezas.	PORT dipstick with 2-piece rear main bearing seal & 4-piece oil pan gasket.	Asticella olio a SINISTRO con paraolio posteriore in 2 pz. e guarnizione coppa da 4 pz.	Jauge d'huile à BABORD avec Joint spi arrière en 2 pièces et joint de carter en 4 pièces.
	REC17981		Varilla aceite de ESTRI-BOR con retén trasero de 2 piezas y junta cárter de 4 piezas.	STARBOARD dipstick with 2-piece rear main bearing seal & 4-piece oil pan gasket	Asticella olio DESTRO con paraolio posteriore in 2 pz e guarnizione coppa da 4 pz.	Jauge d'huile à TRIBORD avec Joint spi arrière en 2 pièces et joint de carter en 4 pièces.
	REF	RETÉN TRASERO CIGÜENAL	CRANKSHAFT REAR SEAL	PARAOLIO POSTERIORE ALBERO MOTORE	JOINT ARRIÈRE DE VILEBREQUIN	
	FEL17725		Retén partido Contrarrotación, goma; 2 piezas	Split seal Rev. rotation, rubber; 2 piece	Controrotazione in 2 pz.	Joint fendu contre-rotatif, caoutchouc ; 2 pcs.
	REF	TAPA VÁLVULAS	VALVE COVER	COPERCHIO VALVOLE	COUVERCLE SOUPAPE	
	REC17931	3852687	Tornillo centro tapa válvulas con juntas.	Molded rubber gaskets incl.	Coperchio punterie con viti centrali.	Fixation par vis centrale
	REC17930	835096	Tornillo en el canto.	Rim bolt desing	Coperchio punterie con viti nel perimetro.	Fixation par 4 vis latérales.
	REF	RETÉN DISTRIBUCIÓN	OIL SEAL TIMING COVER	PARAOLIO DISTRIBUZIONE	JOINT D'HUILE DE DISTRIBUTION	
	REC3853341		Reten contrarrotación. Motor sin tapa distribución de plástico.	Reverse rotation oil seal. Engines without plastic timing cover.	Paraolio controrotante. Motore senza carter distribuzione in plastica.	Joint contre rotation pour moteur sans carter de distribution en plastique.

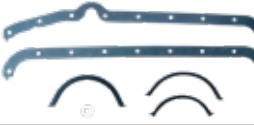







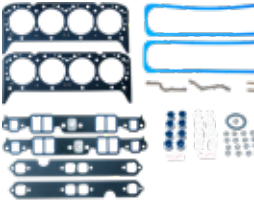
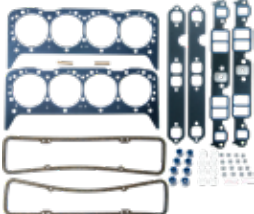
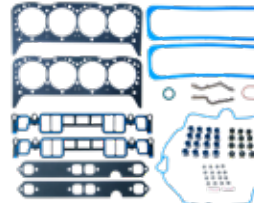



5.0L 307 OHV V8 (210, 215, 225, 230, 235, 245 HP)

	REF	CULATA	CYLINDER HEAD	TESTATA	CULASSE	
	REC17030	3853380	Se necesitan dos	2 required	Ne servono 2	2 sont nécessaires
	REC17230		Kit Juntas Superior Incluye retenes válvulas.	GASKET HEAD SET Premium valve stem seals incl.	KIT PARTE ALTA Incluso tenuta valvole	KIT DE JOINTS SUPERIEURS Comprend les joints de valve.
	REF	INFERIOR	CONVERSION	PORTE BASSA	PARTIE BASSE	
	REC17120		Retén de 2 piezas y junta cárter de 4 piezas	Two-piece rear main bearing seal & 4	Paraolio posteriore in 2 pz e guarnizione coppa in 4 pz.	Joint d'huile en 2 parties et joint de carter en 4 parties.

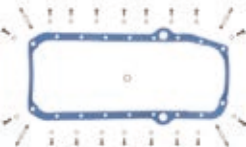
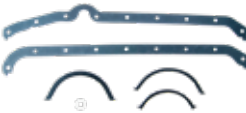









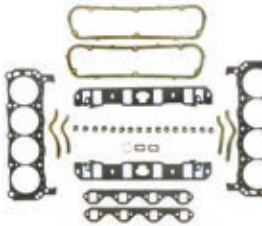

REF	COLECTOR ADMISION-ESCAPE	MANIFOLD INTAKE & EXHAUST	COLLETTORE ASPIRAZIONE-SCARICO	COLLECTEUR ADMISION ET ECHAPPEMENT
 REF REC17320	Kit junta admisión-escape.	Intake-exhaust gasket set.	Kit guarnizioni aspirazione - scarico.	Kit joints d'admission.
 FEL17420	KIT JUNTAS COLECTOR -ESCAPE	OIL PAN - EXHAUST GASKET SET	KIT GUARNIZIONE COPPA OLIO - SCARICO	KIT JOINTS COLLECTEUR D'ÉCHAPPEMENT
REF	CARTER	OIL PAN	COPPA DELL'OLIO	CARTER
 REF REC17980	855729 Varilla aceite a babor con retén trasero de 2 piezas y junta cárter de 4 piezas.	Port dipstick with 2-piece rear main bearing seal & 4-piece oil pan gasket.	Asticella olio a SINISTRO con praolio	Jauge d'huile côté bâbord avec joint d'huile arrière en 2 parties et joint de carter en 4 parties.
REF	RETÉN TRASERO CIGÜENAL	Crankshaft rear seal	PARAOLIO POSTERIORE ALBERO MOTORE	JOINT D'HUILE DE VILEBREQUIN ARRIERE
 REF FEL17725	Retén Contrarrotación de 2 piezas	Split seal Rev. rotation, rubber; 2-piece	Controrotazione in 2 pz.	Joint d'huile contre-rotatif en 2 parties
REF	TAPA VÁLVULAS	VALVE COVER	COPERCHIO VALVOLE	COUVERCLE DE SOUPAPE
 REF REC17930	835096 Tornillo lateral	Rim bolt desing	Coperchio punterie con viti nel perimetro.	Vis latérale
REF	RETÉN DISTRIBUCIÓN	OIL SEAL TIMING COVER	PARAOLIO DISTRIBUZIONE	JOINT D'HUILE DE DISTRIBUTION
 REF REC3853341	Reten contrarrotación. Motor sin tapa distribución de plástico.	Reverse rotation oil seal. Engines without plastic timing cover.	Paraolio controrotante. Motore senza carter distribuzione in plastica.	Joint contre rotation pour moteur sans carter de distribution en plastique.

5.7L V8, 250 (215, 220, 250, 260, 270, 290 HP), 250 KING COBRA ( 235, 270 HP), 260 (250, 260, 270, 290 HP)

REF	CULATA	CYLINDER HEAD	TESTATA	CULASSE
 REF REC17030	Se necesitan dos	2 required	Ne servono 2	2 sont nécessaires
 REF REC17214	Tornillo centro tapa válvulas. Incluye retenes válvulas.	With center bolt desing valve covers. Premium valve stem seals included.	Viti coperchio punterie al centro. Include paraoli valvole.	Cache culbuteur avec les vis centrales. Comprend les joints de queue de soupapes.
 REF REC17230	Tornillo en el lateral tapa válvulas. Incluye retenes válvulas.	Rim bolt desing valve covers. Premium valve stem seals included.	Viti coperchio punterie nel perimetro. Include paraoli valvole.	Cache culbuteur avec les vis laterales. Comprend les joints de queue de soupapes.
 REF REC17232	Gen+ con juntas plástico colector admisión,con juntas tapa válvulas. Retenes válvulas incluidos.	GEN+ w/ plastic intake manifold gskts. valve cover gskts. incl; Premium valve stem seals incl.	Gen+ con guarnizione aspirazione in plastica con guarnizione in goma. Inclusi paraolio valvole.	Gen+ avec joints de collecteur d'admission en plastique, avec joints de cache-soupapes. Joints de soupape inclus.

REF		INFERIOR	CONVERSION	PARTE BASSA	PARTIE BASSE
	REC17125	Retén de 1 pieza y junta cárter de 1 pieza Incluye junta de cárter.	One-piece rear main bearing seal & 1 piece oil pan gasket. Oil pan gasket included.	Paraolio in 1 peze e guarnizione coppa in 1 peze. Include paraolio coppa.	Joint spi 1 pièce. Joint de carter 1 pièce. Comprend le Joint spi.
	FEL17124	Con tapa de distribución de plástico, retén trasero de 1 pieza y junta cárter de 1 pieza. Junta de cárter incluida.	Eng. with plastic timing cover, 1 piece rear main bearing seal & 1 piece oil pan gskt. oil pan gskt incl.	Carter distribuzione in plastica, paraolio posteriore in 1 pz e guarnizione coppa olio in 1 pz.	Avec couvercle de distribution en plastique, joint arrière monobloc et joint de carter monobloc. Joint de carter inclus.
	REC17120	Retén de 2 piezas y junta cárter de 4 piezas	Two-piece rear main bearing seal & 4 pieces oil pan gasket.	Paraolio in 2 peze e guarnizione coppa in 4 pezi.	Joint spi 2 pièces et joint de carter 4 pièces.
REF		COLECTOR ADMISION-ESCAPE	MANIFOLD INTAKE & EXHAUST	COLLETORE ASPIRAZIONE-SCARICO	COLLECTEUR ADMISSION ET ÉCHAPPEMENT
	REC17320	KIT JUNTAS ADMISION-ESCAPE Excepto GEN+ con juntas de admisión de plástico.	INTAKE-EXHAUST GASKET SET Excl. GEN+ eng. w/ plastic intake gaskets.	KIT GUARNIZIONI ASPIRAZIONE Eccetto Gen+ guarnizione in plastica	KIT DE JOINTS ADMISSION-ÉCHAPPEMENT Sauf GEN+ avec joints d'admission en plastique.
	FEL17420	KIT JUNTAS COLECTOR -ESCAPE	OIL PAN - EXHAUST GASKET SET	KIT GUARNIZIONE COPPA OLIO - SCARICO	KIT JOINTS COLLECTEUR D'ÉCHAPPEMENT
REF		CARTER	OIL PAN	COPPA DELL'OLIO	CARTER
	REC17982	3856138 Junta cárter 1 pieza. Junta de cárter incluida.	1 piece oil pan gasket. Molded rubber oil pan gasket included.	Guarnizione in 1 pz. Guarnizione coppa included.	Joint de carter 1 pièce.
	FEL17983	Junta 1 pieza. Para motores con retén trasero de 2 piezas.	1 piece molded rubber gasket for engines with Two-piece rear main bearing sea.	Guarnizione in 1 pz, paraolio posteriore in 2 px.	Joint de carter 1 pièce pour moteurs avec Joint spi arrière 2 pièces.
	REC17980	855729 Varilla aceite de BABOR con retén trasero de 2 piezas y junta cárter de 4 piezas.	PORT dipstick with 2-piece rear main bearing seal & 4-piece oil pan gasket.	Asticella olio a SINISTRO con paraolio posteriore in 2 pz. e guarnizione coppa da 4 pz.	Jauge d'huile à BABORD avec Joint spi arrière en 2 pièces et joint de carter en 4 pièces.
	REC17981	Varilla aceite de ESTRIBOR con retén trasero de 2 piezas y junta cárter de 4 piezas.	STARBOARD dipstick with 2-piece rear main bearing seal & 4-piece oil pan gasket	Asticella olio DESTRO con paraolio posteriore in 2 pz e guarnizione coppa da 4 pz.	Jauge d'huile à TRIBORD avec Joint spi arrière en 2 pièces et joint de carter en 4 pièces.
REF		RETÉN TRASERO CIGÜENAL	Crankshaft rear seal	PARAOLIO POSTERIORE ALBERO MOTORE	JOINT D'HUILE DE VILEBREQUIN ARRIÈRE
	FEL17725	Retén Contrarrotación de 2 piezas	Split seal Rev. rotation, rubber; 2-piece	Controrotazione in 2 pz.	Joint d'huile contre-rotatif en 2 parties
REF		TAPA VÁLVULAS	VALVE COVER	COPERCHIO VALVOLE	COUVERCLE DE SOUPAPE
	REC17931	3852687 Tornillo centro tapa válvulas con juntas.	Molded rubber gaskets incl.	Coperchio punterie con viti centrali.	Fixation par vis centrale
	REC17930	835096 Tornillo en el canto.	Rim bolt desing	Coperchio punterie con viti nel perimetro.	Fixation par 4 vis laterales.
REF		RETÉN DISTRIBUCIÓN	OIL SEAL TIMING COVER	PARAOLIO DISTRIBUZIONE	JOINT D'HUILE DE DISTRIBUTION
	REC3853341	Reten contrarrotación Motor sin tapa distribución de plástico.	Reverse rotation oil seal Engines w/o plastic timing cover.	Paraolio controrrotante. Motore senza carter distribuzione in plastica.	Joint de contre-rotation du moteur sans cache-soupape en plastique.



5.8L (210, 215, 235 HP), 5.8L COBRA (240 HP), 250HP, 351 KING COBRA (260 HP)

REF	CULATA	CYLINDER HEAD	TESTATA	CULASSE	
 FEL17060	Se necesitan dos	2 required	Necessarie 2	Deux sont nécessaires	
 FEL17261	Con tapa válvulas de aluminio. Incluye retenes de válvulas.	With cast aluminum valve covers. Premium valve stem seals included.	Con coperchio punterie in alluminio. Include paraolio valvole.	Avec le cache culbuteur en Aluminium. Comprend les joints de queue de soupape.	KIT DE JOINTS SUPERIEURS Avec couvercle de valves en AL. Comprend les joints de valve.
 FEL17260	Incluye retenes de válvulas.	Premium valve stem seals included.	Include paraoli valvole.	Comprend les joints de queue de soupape.	
REF	INFERIOR	CONVERSION	PARTE BASSA	PARTIE BASSE	
 FEL17166	KIT JUNTAS INFERIOR Retén de una pieza y 1 pieza junta cárter, incluye junta de cárter de goma.	CONVERSION GASKET SET With 1 piece rear main bearing seal Et 1 piece oil pan gasket; rubber oil pan gasket included	KIT PARTE BASSA Paraolio in 1 pz e guarnizione coppa dell'olio in 1 pz.		
 FEL17165	KIT JUNTAS INFERIOR Gene V con retén trasero de una pieza y junta cárter de 1 pieza. Junta cárter de goma incluida.	CONVERSION GASKET SET Gene V w/one piece rear main bearing seal Et one piece oil pan gskt. Rubber oil pan gasket incl.	KIT PARTE BASSA Gen V con paraolio posteriore di 1 pz e guarnizione coppa in 1 pz.	KIT JOINTS	
 REC17146	KIT JUNTAS INFERIOR Retén de 2 piezas y 4 piezas junta cárter	CONVERSION GASKET SET With 2 piece rear main bearing seal Et 4 piece oil pan gasket	KIT PARTE BASSA Paraolio in 2 pz e guarnizione coppa in 4 pz.		
REF	COLECTOR ADMISION-ESCAPE	MANIFOLD INTAKE & EXHAUST	COLLETORE ASPIRAZIONE-SCARICO	COLLECTEUR ADMISION ET ÉCHAPPEMENT	
 FEL17360	Kit junta admisión	Intake gasket set	Kit guarnizioni aspirazione	Kit joints d'admission	KIT JOINTS ADMISION
 REC3852455	Junta escape	Exhaust gasket	Guarnizione scarico	Joints collecteur d'échappement	KIT JOINTS D'ÉCHAPPEMENT
REF	CARTER	OIL PAN	COPPA DELL'OLIO	CARTER	
 FEL17996	KIT JUNTAS	GASKET SET	KIT GUARNIZIONE	KIT JOINTS	
 FEL17998	1 pieza junta cárter incluye junta de goma.	With 1 piece oil pan gasket. Rubber gasket included.	Guarnizione coppa in 1 pz.		
REF	TAPA VÁLVULAS	VALVE COVER	COPERCHIO VALVOLE	COUVERCLE	
 FEL17945	835096 Con tapa de válvulas de acero	With iron valve cover	Con coperchio valvole in acciaio	Cache culbuteur en acier	
 FEL17946	3852687 Con tapa válvulas de aluminio.	With cast aluminium valve covers.	Con coperchio valvole in alluminio.	Cache culbuteur en Aluminium	



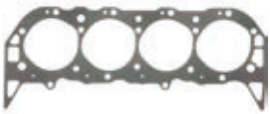
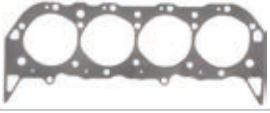
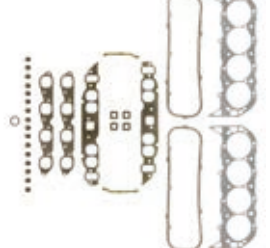
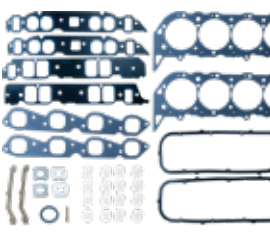
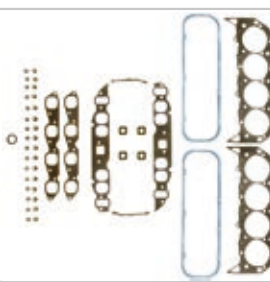
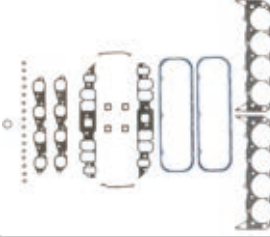
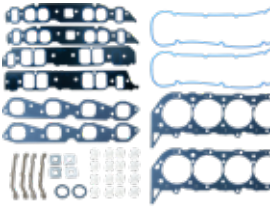
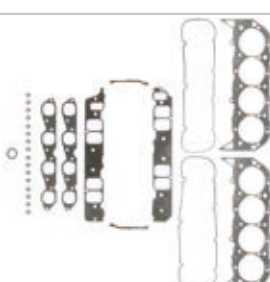

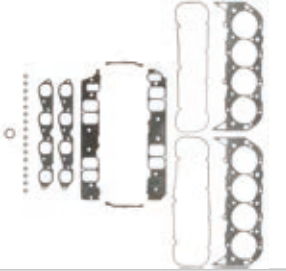
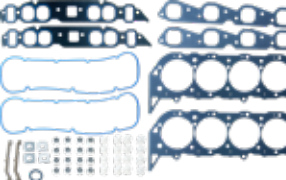
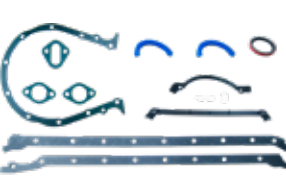
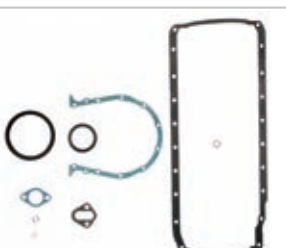
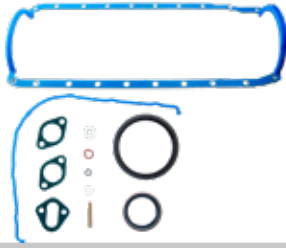
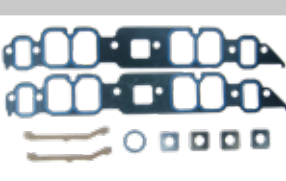
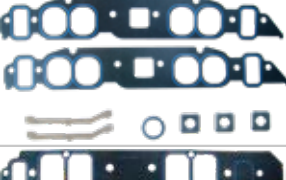
7.4 L, 454 (330, 335 HP GEN IV)  
HIGH OUTPUT KING COBRA (370 HP GEN IV, 330 HP GEN V),  
454 KING COBRA (275, 295, 310 HP GEN IV, 295, 310 GEN V)

	REF	CULATA	CYLINDER HEAD	TESTATA	CULASSE
	REC17040	Gene IV Se necesitan dos	Gene IV 2 required	Gene IV Necessarie 2	Gene IV Deux sont nécessaires
	REC17042	Gene IV & V. Se necesitan 2.	Gene IV & V. 2 required	Gene IV e V. Necessarie 2	Gène IV & V. 2 requis.
	REC17240	Gen IV exc. H.O. con admisión ovalada. Se incluye retenes de válvula.	Gen IV exc. H.O. with oval intake ports. Premium valve stem seals included.	Gen IV escluso H.O. con aspirazione ovale. Inclusi paraoli valvole.	Gen IV exc. H.O. avec admission ovale. Joints de queue de soupape inclus.
	REC17241	Gene IV solo H.O. Se incluye retenes de válvula	Gene IV only H.O.premium valve stem seals incl.	Gene IV solo H.O. Inclusi paraoli valvole.	Gene IV uniquement H.O. Joints de soupape inclus
	FEL17244	Gen V Excepto EFI o H.O.Juntas tapa válvula de goma.Se incluye retenes de válvula.	Gen V premium excl. EFI or H.O. Rubber valve cover & valve stem seals included.	Gen V escluso EFI o H.O. inclusi paraoli valvole.	Gen V sauf EFI et H.O. joints de couvre- soupapes et joints en caoutchouc inclus.
	FEL17245	Gen V con retén trasero de una pieza y junta cárter de 1 pieza. Junta cárter incluida.	Gen V with one piece rear main bearing seal & one piece oil pan gasket. Oil pan gasket included.	Gen V con paraolio posteriore in 1 pz. e guarnizione coppa dell'olio in 1 pz.	Gen V avec joint arrière en 1 pièce et joint de carter en 1 pièce. Joint de carter inclus.
	REC17242	Gen V EFI y H.O. Se incluye retenes de válvula. Gen VI. EFI y H.O. juntas de goma de tapa válvulas y retenes incluidos	Gen V. EFI or H.O. ; premium valve stem seals incl. Gen VI, EFI & H.O. molded rubber valve cover gaskets and premium valve stem seals incl.	Gen V EFI e H.O. Include paraoli valvole. Gen VI, EFI e H.O., guarnizione coperchio punterie e paraoli inclusi.	Gen V EFI et H.O. Joint de soupape inclus. Gen VI. EFI et H.O. joints de couvre-soupapes et joints en caoutchouc inclus.
	FEL17205	Gen VI sólo EFI Juntas de tapa válvulas y retenes incluidos.	Gen VI, EFI only, valve cover gaskets and premium valve stem seals incl.	Gen VI, solo EFI guarnizione rettangolare, guarnizione coperchio punterie e paraoli inclusi.	Gen V EFI uniquement. Joints de cache culbuteur et joints de queue de soupape inclus.

	FEL17205	Kit Juntas Superior Gene VI sólo EFI Juntas de tapa válvulas y retenes incluidos.	GASKET HEAD SET Gen VI, EFI only, valve cover gaskets and premium valve stem seals incl.	KIT PARTE ALTA Gene VI, solo EFI guarnizione rettangolare, guarnizione coperchio punterie e paraoli inclusi.	KIT DE JOINTS SUPÉRIEURS Gene VI EFI uniquement Joints de couvre-soupape et joints inclus.
	REC17243	Gene VI sólo H.O. Se incluye retenes de válvula. Juntas tapa válvula de goma.	Gen VI only H.O. Rubber valve cover & premium valve stem seals incl.	Gene VI solo H.O. Inclusi paraoli valvole.	KIT DE JOINTS SUPÉRIEURS Gene VI re Joints de couvre-soupape et joints inclus.
	REF	INFERIOR	CONVERSION	PARTE BASSA	PARTIE INFÉRIEUR
	REC17140	Gene IV con retén trasero de dos piezas y junta cárter de 4 piezas.	Gene IV w/two piece rear main bearing seal & four piece oil pan gasket.	Gene IV con paraolio posteriore in 2 pz. e guarnizione coppa dell'olio in 4 pz.	Gene IV avec joint arrière en deux parties et joint de carter en 4 parties.
	FEL17145	Gene V con retén trasero de una pieza y junta cárter de 1 pieza. Junta cárter incluida.	Gene V w/one piece rear main bearing seal & one piece oil pan gasket. oil pan gasket. incl.	Gene V con paraolio posteriore in 1 pz. e guarnizione coppa dell'olio in 1 pz.	Gene V avec joint arrière monobloc et joint de carter monobloc. Joint de carter inclus.
	REC17146	Gene VI con retén trasero de una pieza y junta cárter de 1 pieza. Junta cárter incluida.	Gene VI w/one piece rear main bearing seal & one piece oil pan gasket. incl.	Gene VI con paraolio posteriore in 1 pz. e guarnizione coppa dell'olio in gomma in 1 pz.	Gene VI avec joint à lèvres arrière en une seule pièce et joint de carter en une seule pièce. Joint de carter inclus.
	REF	COLECTOR ADMISIÓN-ESCAPE	MANIFOLD INTAKE & EXHAUST	COLLETTORE ASPIRAZIONE-SCARICO	COLLECTEUR ADMISION ET ÉCHAPPEMENT
	REC17341	KIT JUNTA ADMISIÓN Gene IV, V y VI sólo H.O. con admisión rectangular. Gene IV, excl. H.O. con admisión rectangular.	INTAKE GASKET SET Gene IV, V & VI, H.O. only w/rectangular intake ports Gene IV excl. H.O. w/rect. intake ports	KIT GUARNIZIONI ASPIRAZIONE Gene IV, V e VI solo H.O. con aspirazione rettangolare Gene IV escluso H.O. con aspirazione rettangolare	KIT DE JOINTS D'ADMISSION Gènes IV, V et VI uniquement H.O. avec admission rectangulaire. Gene IV, excl. H.O. avec admission rectangulaire.
	REC17340	KIT JUNTA ADMISIÓN Gene IV, excl. H.O. con admisión oval. Gene V y VI exc. EFI y H.O. con admisión ovalada.	INTAKE GASKET SET Gene IV excl. H.O. w/oval intake ports Gene V & VI, excl. EFI & H.O. w/oval intake ports	KIT GUARNIZIONI ASPIRAZIONE Gene IV escluso H.O. con aspirazione ovale. Gene V e VI escluso EFI e H.O. con aspirazione ovale	KIT DE JOINTS D'ADMISSION Gene IV, excl. H.O. avec prise ovale. Gène V et VI exc. EFI et H.O. avec admission ovale.
	REC17342	KIT JUNTA ADMISIÓN Gene V y VI sólo EFI	INTAKE GASKET SET Gene V & VI, EFI only	KIT GUARNIZIONI ASPIRAZIONE Gene V e VI, solo EFI	KIT DE JOINTS D'ADMISSION Gene V et VI EFI uniquement
	REC27-46820 3852472	KIT JUNTA ESCAPE Gene IV, V y VI.	EXHAUST GASKET SET Gene IV, V & VI	KIT GUARNIZIONI SCARICO Gene IV, V e VI	KIT DE JOINTS D'ÉCHAPPEMENT Gène IV, V et VI.



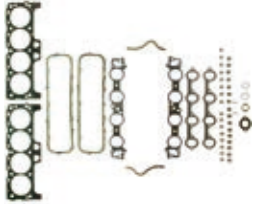
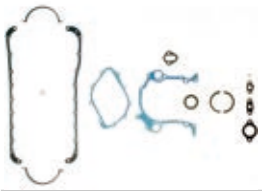
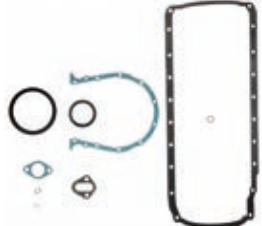

REF	RETÉN TRASERO CIGÜENAL	Crankshaft rear seal	PARAOLIO POSTERIORE ALBERO MOTORE	JOINT D'HUILE DE VILEBREQUIN ARRIERE	
	REC26-14756	Gene IV Retén Contrarrotación dos piezas	Gene IV Reverse rotation oil seal Two-pieces	Gene IV Controrotante in 2 pz.	Gene IV Joint d'huile contre-rotatif en deux parties
REF	TAPA VÁLVULAS	VALVE COVER	COPERCHIO VALVOLE	COUVERCLE SOUPAPES	
	REC17935 856626	Gene IV	Gene IV	Gene IV	Gene IV
	FEL17936	KIT JUNTA TAPA VÁLVULAS Gen V solo EFI Juntas de goma incluidas.	GASKET SET Gene V EFI only molded rubber gaskets incl.	GUARNIZIONE COPERCHIO PUNTERIE Gen V solo EFI Kit tenuta inclusa	KIT JOINTS DE COUVERCLE DE SOUPAPE Gen V seulement EFI. Comprend des joints en caoutchouc.
	REC17937 3853513	Gene V & VI	Gene V & VI	Gene V e VI	Gene V et VI

### 7.5 L, V8, 460 KING COBRA (295, 340 HP)





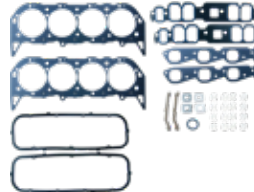
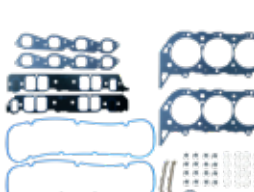
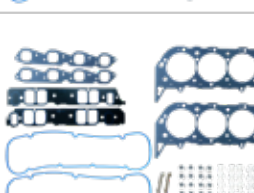

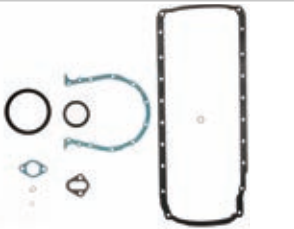

REF	CULATA	CYLINDER HEAD	TESTATA	CULASSE	
FEL17068	JUNTA CULATA Se necesitan dos	CYLINDER HEAD 2 required	GUARNIZIONE TESTATA Necessarie 2	JOINT DE CULASSE Deux sont nécessaires	
	FEL17268	KIT JUNTAS CULATA Se incluye retenes de válvula	CYLINDER HEAD SET Premium valve stem seals included.	KIT GUARNIZIONE TESTATA Si incluyen paraoli valvole	KIT JOINTS DE CULASSE Comprend joints de valve.
REF	INFERIOR	CONVERSION	PARTE BASSA	PARTIE INFÉRIEUR	
	FEL17168	KIT JUNTAS INFERIOR Retén trasero de 2 piezas y junta cárter de 4 piezas.	CONVERSION GASKET SET 2 piece rear main bearing seal & 4 piece oil pan gasket.	KIT PARTE BASSA Paraolio posteriore in 2 pz e guarnizione coppa in 4 pz.	Gene IV avec joint arrière en deux parties et joint de carter en 4 parties.
	FEL17169	KIT JUNTAS INFERIOR con retén trasero de 2 piezas y junta cárter de 1 pieza. Junta cárter de goma incluida.	CONVERSION GASKET SET 2 piece rear main bearing seal & 1 piece oil pan gasket rubber oil pan gasket incl.	KIT PARTE BASSA paraolio posteriore di 2 pz e guarnizione coppa in 1 pz.	Gene V avec joint arrière monobloc et joint de carter monobloc. Joint de carter inclus.
REF	COLECTOR ADMISIÓN-ESCAPE	MANIFOLD INTAKE & EXHAUST	COLLETORE ASPIRAZIONE-SCARICO	COLLECTEUR ADMISSION ET ÉCHAPPEMENT	
	FEL17368	JUNTA ADMISIÓN 4 piezas	INTAKE GASKET 4 piece	GUARNIZIONE ASPIRAZIONE 4 pz	KIT DE JOINTS D'ADMISSION 4 pièces
	FEL17468	JUNTA ESCAPE	EXHAUST GASKET	GUARNIZIONE SCARICO	KIT DE JOINTS D'ADMISSION

REF	TAPA VÁLVULAS	VALVE COVER	COPERCHIO VALVOLE	COUVERCLE SOUPAPES	
	FEL17947	KIT JUNTAS	GASKET SET	KIT GUARNIZIONI	KIT JOINTS
REF	CARTER	OIL PAN	COPPA DELL'OLIO	CARTER	
	FEL17994	JUNTA CARTER 1 pieza, incluye junta de goma	GASKET OIL PAN 1 piece oil pan gasket. Rubber gasket included.	GUARNIZIONE 1 pz, guarnizione in gomma inclosa	JOINT DE CARTER 1 pièce avec joint en caoutchouc

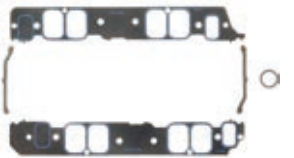
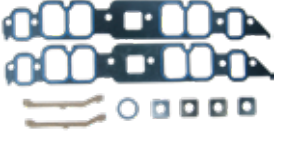
**8.2 L, 502 KING COBRA (375 HP GEN IV, 375 HP GEN V)**

REF	CULATA	CYLINDER HEAD	TESTATA	CULASSE	
	FEL17049	JUNTA CULATA Gene IV, V & VI sólo H.O. super medida. Se necesitan 2.	CYLINDER HEAD Gene IV, V & VI H.O. only super bore 2 required	GUARNIZIONE TESTATA Gene IV, V & VI solo H.O. maggiorata. Necessarie 2	JOINT CULATA Gene IV, V & VI seulement H.O. super taille. 2 sont nécessaires.
	REC17048	JUNTA CULATA Gene IV, V & VI .Se necesitan 2.	CYLINDER HEAD Gene IV, V & VI. 2 required	GUARNIZIONE TESTATA Gene IV, V e VI. necessita 2	JOINT CULATA Gene IV, V & VI. 2 nécessaire.
	REC17248	KIT JUNTAS SUPERIOR Gene IV. Se incluye retenes de válvula.	GASKET HEAD SET Gene IV. premium valve stem seals incl.	KIT PARTE ALTA Gene IV. Se incluye paraolio valvole.	KIT DE JOINTS SUPÉRIEURS Gene IV. Joints de soupape inclus.
	REC17248	KIT JUNTAS SUPERIOR Gene V exc. EFI. Se incluye retenes de válvula y juntas tapa válvulas.	GASKET HEAD SET Gene V exc. EFI; premium valve stem seals & valve cover gskts.incl.	KIT PARTE ALTA Gene IV escluso EFI. Include paraolio e guarnizione del coperchio valvola	KIT DE JOINTS SUPÉRIEURS GENE V exc. EFI. Les joints de soupape et les joints de couvercle de soupape sont inclus.
	REC17207	KIT JUNTAS SUPERIOR Gene V solo EFI. Se incluye retenes de válvula y juntas tapa válvulas.	GASKET HEAD SET Gene V EFI only; premium valve stem seals & valve cover gskts. incl.	KIT PARTE ALTA Gene V solo EFI. Include paraolio e guarnizione del coperchio valvola	KIT DE JOINTS SUPÉRIEURS Gene V EFI uniquement. Les joints de soupape et les joints de couvercle de soupape sont inclus.
	REC17207	KIT JUNTAS SUPERIOR Gene VI solo EFI. Se incluye retenes de válvula y juntas tapa válvulas	GASKET HEAD SET Gene VI EFI only; premium valve stem seals & valve cover gskts. incl.	KIT PARTE ALTA Gene VI solo EFI. Include paraolio e guarnizione del coperchio valvola	KIT DE JOINTS SUPÉRIEURS Gene VI EFI uniquement. Les joints de soupape et les joints de couvercle de soupape sont inclus.
REF	INFERIOR	CONVERSION	PARTE BASSA	PARTIE BASSE	
	REC17140	Gene IV con retén trasero de dos piezas y junta cárter de 4 piezas.	Gene IV w/two piece rear main bearing seal & four piece oil pan gasket.	Gene IV con paraolio posteriore in 2 pz. e guarnizione coppa dell'olio in 4 pz.	Gene IV avec joint arrière en deux parties et joint de carter en 4 parties.









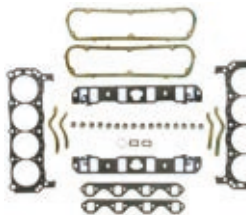

	FEL17145	Gene V con retén trasero de una pieza y junta cárter incluida.	Gene V w/one piece rear main bearing seal & one piece oil pan gasket. oil pan gasket. incl.	Gene V con paraolio posteriore in 1 pz. e guarnizione coppa dell'olio in 1 pz.	Gene IV avec joint arrière en deux parties et joint de carter en 4 parties.
	REC17146	Gene VI con retén trasero de una pieza y junta cárter incluida.	Gene VI w/one piece rear main bearing seal & one piece oil pan gasket. oil pan gasket. incl.	Gene VI con paraolio posteriore in 1 pz. e guarnizione coppa dell'olio in gomma in 1 pz.	Gene VI avec joint arrière monobloc et joint de carter inclus.
	REF	COLECTOR ADMISION-ESCAPE	MANIFOLD INTAKE & EXHAUST	COLLETTORE ASPIRAZIONE-SCARICO	COLLECTEUR ADMISION ET ECHAPPEMENT
	FEL17342	JUNTA ADMISION Gene V & VI solo EFI	INTAKE GASKET Gene V & VI only EFI	GUARNIZIONE ASPIRAZIONE Gene V & VI solo EFI	JOINT ADMISION Gene V et VI seulement EFI
	REC17341	KIT JUNTA ADMISION Gene IV, V y VI sólo H.O. con admisión rectangular. Gene IV, excl. H.O. con admisión rectangular.	INTAKE GASKET SET Gene IV, V & VI, H.O. only w/rectangular intake ports Gene IV excl. H.O. w/rect. intake ports	KIT GUARNIZIONI ASPIRAZIONE Gene IV, V e VI solo H.O. con aspirazione rettangolare Gene IV escluso H.O. con aspirazione rettangolare	KIT DE JOINTS D'ADMISSION Gènes IV, V et VI uniquement H.O. avec admission rectangulaire. Gene IV, excl. H.O. avec admission rectangulaire.
	REC27-46820	KIT JUNTA ADMISION Gene IV, excl. H.O. con admisión oval. Gene V y VI exc. EFI y H.O. con admisión ovalada.	INTAKE GASKET SET Gene IV excl. H.O. w/oval intake ports Gene V & VI, excl. EFI & H.O. w/oval intake ports	KIT GUARNIZIONI ASPIRAZIONE Gene IV escluso H.O. con aspirazione ovale. Gene V e VI escluso EFI e H.O. con aspirazione ovale PARAOLIO POSTERIORE ALBERO MOTORE	KIT DE JOINTS D'ADMISSION Gene IV, excl. H.O. avec prise ovale. Gène V et VI exc. EFI et H.O. avec adm ission ovale. JOINT D'HUILE DE VILEBREQUIN ARRIERE
	REF	RETÉN TRASERO CIGÜEÑAL	CRANKSHAFT REAR SEAL		
	REC26-14756	Gene IV Retén Contrarrrotación dos piezas	Gene IV Reverse rotation oil seal Two- pieces	Gene IV Controrrotante in 2 pz.	Gene IV Joint d'huile contre-rotatif en deux parties
	REF	TAPA VÁLVULAS	VALVE COVER	COPERCHIO VALVOLE	COUVERCLE SOUPPES
	REC17935	Gene IV	Gene IV	Gene IV	Gene IV
	REC17937	Gene V & VI	Gene V & VI	Gene V e VI	Gene V et VI
	REF	CARTER	OIL PAN	COPPA DELL'OLIO	CARTER
	FEL17985	Junta Carter Gene IV Junta de 4 piezas.	GASKET OIL PAN Gene IV with 4 piece oil pan gasket.	GUARNIZIONE Gene IV, 4 pz,	JOINT Gen IV Joint de 4 pièces
	REC17986	Junta Carter 1 pieza, incluye junta de goma	GASKET OIL PAN 1 piece oil pan gasket. rubber gasket included.	GUARNIZIONE 1 pz, guarnizione in gomma inclusa	JOINT 1 pièce avec joint en caoutchouc

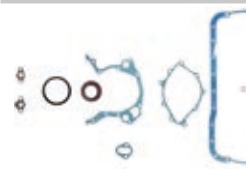
## 4 CIL 2.3L FORD







REF	COLECTOR ADMISION-ESCAPE	MANIFOLD INTAKE & EXHAUST	COLLETTORE ASPIRAZIONE-SCARICO	COLLECTEUR ADMISION ET ÉCHAPPEMENT
 REC913393	913393 JUNTA ESCAPE	EXHAUST GASKET	GUARNIZIONE SCARICO	JOINT D'ÉCHAPPEMENT

## 8 CIL 5.0 L (160, 170, 185 HP), 5.0L HIGH OUTPUT (175, 190, 200 HP), 175 HP, 190 HP - FORD 302 (5.0)

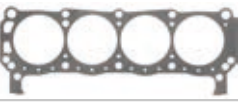
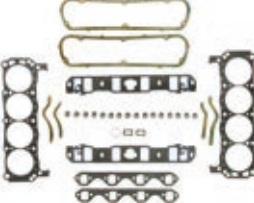
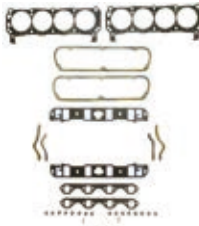
REF	CULATA	CYLINDER HEAD	TESTATA	CULASSE
 FEL17060	Se necesitan dos	2 required	Necessarie 2	Deux sont nécessaires
 FEL17260	Incluye retenes de válvulas.	Premium valve stem seals included.	Include paraoli valvole.	Comprend les joints de queue de soupape.
 FEL17261	Con tapa válvulas de aluminio. Incluye retenes de válvulas.	With cast aluminum valve covers. Premium valve stem seals included.	Con coperchio punterie in alluminio. Include paraolio valvole.	Avec le cache culbuteur en Aluminium. Comprend les joints de queue de soupape.
REF	INFERIOR	CONVERSION	PARTE BASSA	PARTIE BASSE
 FEL17161	Retén 1 piezas, 1 pieza junta cárter. Incluye junta de cárter.	1 piece rear main bearing seal & 1 piece oil pan gasket. Rubber oil pan gasket included.	Paraolio in 1 pz, 1 pz guarnizione coppa dell'olio. Include guarnizione coppa.	Joint spi 1 pièce Joint de carter 1 pièce. Comprend le joint de carter.
 FEL17160	Retén 2 piezas, 4 piezas junta cárter.	2 piece rear main bearing seal & 4 piece oil pan gasket.	Paraolio in 2 pz, 4 pz guarnizione coppa dell'olio.	Joint spi 2 pièces Joint de carter 4 pièces.
REF	COLECTOR ADMISION-ESCAPE	MANIFOLD INTAKE & EXHAUST	COLLETTORE ASPIRAZIONE-SCARICO	COLLECTEUR ADMISION ET ÉCHAPPEMENT
 FEL17360	Kit junta admisión	Intake gasket set	Kit guarnizioni aspirazione	Kit joints d'admission
 REC3852455	Junta escape	Exhaust gasket	Guarnizione scarico	Joints collecteur d'échappement
REF	CARTER	OIL PAN	COPPA DELL'OLIO	CARTER
 FEL17995	JUNTA CARTER 4 piezas.	GASKET OIL PAN 4 piece	GUARNIZIONE 4 pz,	JOINT 4 pièce
 FEL17997	JUNTA CARTER 1 pieza	GASKET OIL PAN 1 piece	GUARNIZIONE 1 pz,	JOINT 1 pièce

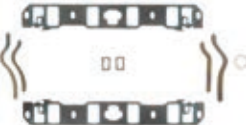



	REF	RETÉN TRASERO CIGÜEÑAL	CRANKSHAFT REAR SEAL	PARAOLIO POSTERIORE ALBERO MOTORE	JOINT D'HUILE DE VILEBREQUIN ARRIÈRE
	FEL17746	KIT JUNTAS Contrarrotación	GASKET KIT Rev. rotation	KIT GUARNIZIONE. controrotante	KIT JOINTS contro-rotatif
	REF	TAPA VÁLVULAS	VALVE COVER	COPERCHIO VALVOLE	COUVERCLE SOUPPES
	FEL17945	Con tapa de válvulas de acero	With iron valve cover	Con coperchio valvole in acciaio	Cache culbuteur en acier

**8 CIL**  
**5.8L (210, 215, 235 HP), 5.8L COBRA (240 HP),**  
**250 HP, 351 KING COBRA (260 HP), FORD 351W**

	REF	CULATA	CYLINDER HEAD	TESTATA	CULASSE
	FEL17060	Se necesitan dos	2 required	Necessarie 2	Deux sont nécessaires
	FEL17260	Incluye retenes de válvulas.	Premium valve stem seals included.	Include paraoli valvole.	Comprend les joints de queue de soupape.
	FEL17261	Con tapa válvulas de aluminio. Incluye retenes de válvulas.	With cast aluminum valve covers. Premium valve stem seals included.	Con coperchio punterie in alluminio. Include paraolio valvole.	Avec le cache culbuteur en Aluminium. Comprend les joints de queue de soupape.
	REF	INFERIOR	CONVERSION	PARTE BASSA	PARTIE BASSE
	FEL17165	KIT JUNTAS INFERIOR 4 piezas.	CONVERSION GASKET SET 4 piece oil pan gasket.	KIT PARTE BASSA 4 pz	Gene IV avec joint arrière en deux parties
	FEL17166	KIT JUNTAS INFERIOR 1 pieza	CONVERSION GASKET SET 1 piece	KIT PARTE BASSA 1 pz	KIT JOINTS INFÉRIEUR 1 pièce
	REF	COLECTOR ADMISION-ESCAPE	MANIFOLD INTAKE & EXHAUST	COLLETORE ASPIRAZIONE-SCARICO	COLLECTEUR ADMISSION ET ÉCHAPPEMENT
	FEL17360	Kit junta admisión	Intake gasket set	Kit guarnizioni aspirazione	Kit joints d'admission
	REC3852455	Junta escape	Exhaust gasket	Guarnizione scarico	Joint collecteur d'échappement
	REF	CARTER	OIL PAN	COPPA DELL'OLIO	CARTER
	FEL17996	Junta Carter 4 piezas.	GASKET OIL PAN 4 piece	GUARNIZIONE 4 pz,	JOINT 4 pièce
	FEL17998	Junta Carter 1 pieza	GASKET OIL PAN 1 piece	GUARNIZIONE 1 pz,	JOINT 1 pièce

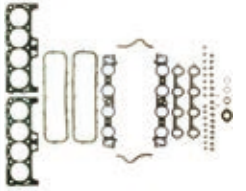
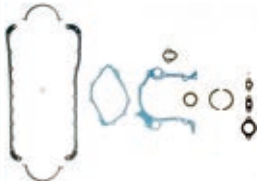
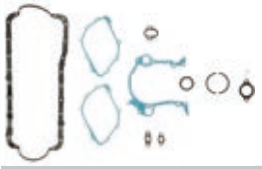
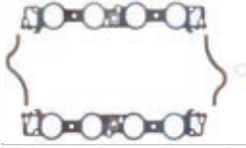
	REF	TAPA VÁLVULAS	VALVE COVER	COPERCHIO VALVOLE	COUVERCLE SOUPPES
	FEL17945	Con tapa de válvulas de acero	With iron valve cover	Con coperchio valvole in acciaio	Cache culbuteur en acier
	FEL17946	Con tapa válvulas de aluminio.	With cast aluminium valve covers.	Con coperchio valvole in alluminio.	Cache culbuteur en Aluminium

**8 CIL  
460 KING COBRA (295, 340 HP), FORD 460 (7.5L)**

	REF	CULATA	CYLINDER HEAD	TESTATA	CULASSE
	FEL17068	JUNTA CULATA	CYLINDER HEAD	GUARNIZIONE TESTATA	JOINT CULATA
	FEL17268	KIT JUNTAS Con tapa válvula sellada	GASKET SET Sealed valve cover	KIT GUARNIZIONE Coperchio valvole in acciaio	KIT DE JOINTS SUPÉRIEURS Avec couvercle valves hermétique
	REF	INFERIOR	CONVERSION	PARTE BASSA	PARTIE BASSE
	FEL17168	KIT JUNTAS INFERIOR 4 piezas.	CONVERSION GASKET SET 4 piece oil pan gasket.	KIT PARTE BASSA 4 pz	KIT JOINTS INFÉRIEUR 4 pièces
	FEL17169	KIT JUNTAS INFERIOR 1 pieza	CONVERSION GASKET SET 1 piece	KIT PARTE BASSA 1 pz	KIT JOINTS INFÉRIEUR 1 pièce
	REF	COLECTOR ADMISIÓN-ESCAPE	MANIFOLD INTAKE & EXHAUST	COLLETTORE ASPIRAZIONE-SCARICO	COLLECTEUR ADMISSION ET ÉCHAPPEMENT
	FEL17368	KIT JUNTA ADMISIÓN	INTAKE GASKET SET	KIT GUARNIZIONE ASPIRAZIONE	KIT DE JOINTS D'ADMISSION
	FEL17468	KIT JUNTA ESCAPE	EXHAUST GASKET SET	KIT GUARNIZIONE SCARICO	KIT DE JOINTS D'ÉCHAPPEMENT
	REF	CARTER	OIL PAN	COPPA DELL'OLIO	CARTER
	FEL17994	Junta Carter 1 pieza	GASKET OIL PAN 1 piece	GUARNIZIONE 1 pz,	JOINT 1 pièce
	REF	TAPA VÁLVULAS	VALVE COVER	COPERCHIO VALVOLE	COUVERCLE SOUPPES
	FEL17947	KIT JUNTAS	GASKET KIT	KIT GUARNIZIONE	KIT JOINTS



# SISTEMA DE ESCAPE Y ADMISIÓN EXHAUST & INTAKE SYSTEM

## SISTEMA DI SCARICO E ASPIRAZIONE SYSTEME D'ÉCHAPPEMENT ET D'ADMISSION

DESPIECES COLECTORES Y CODOS / MANIFOLDS & ELBOWS PARTS / PARTI COLLETTORI E GOMITI / PIÈCES COLLECTEURS ET COUDES

120HP, 4 CYL. 153CID / 2.5L GM SERIES 400

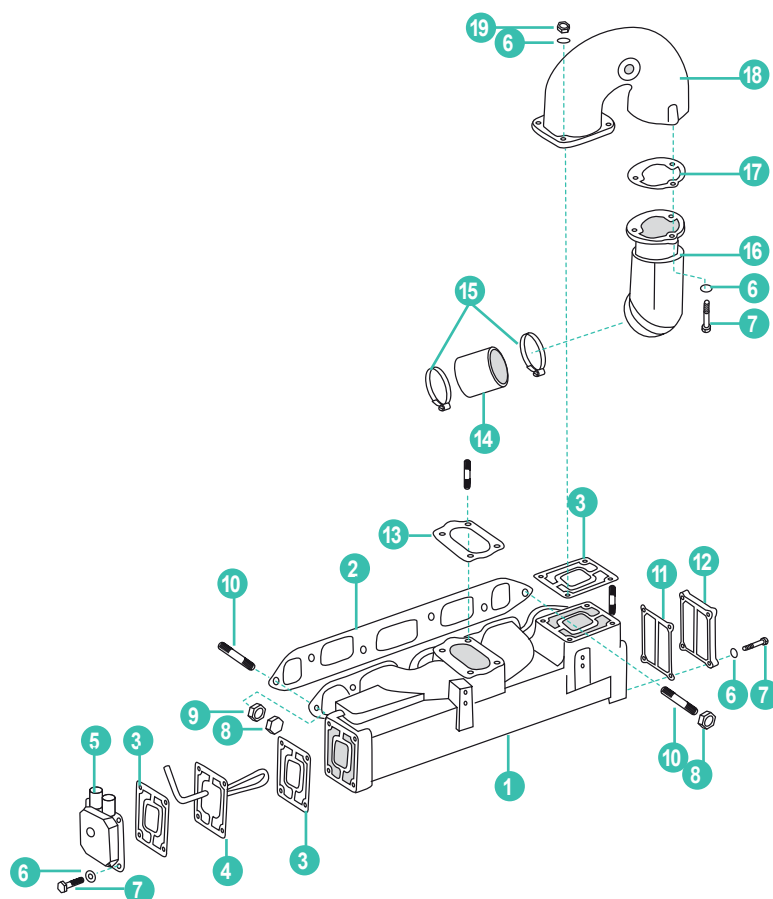

	REF	OEM				
1	BAOMC1-981462	981462	COLECTOR ESCAPE	EXHAUST MANIFOLD ASSEMBLY	COLLETTORE SCARICO	COLLECTEUR D'ÉCHAPPEMENT
2	REC27-52546	311068	JUNTA COLECTOR	GASKET - EXHAUST MANIFOLD	GUARNIZIONE	JOINT DE COLLECTEUR
3	REC311121	311121	JUNTA CODO A TAPA	GASKET - EXHAUST ELBOW AND END CAP	GUARNIZIONE	JOINT COUDE À COUVERCLE
4	BA1-380446	380446	INTERCAMBIADOR DE CALOR	HEAT EXCHANGE ASSEMBLY	SCAMBIATORE DI CALORE	ÉCHANGEUR
5	BA1-910280	910280	TAPA DELANTERA	END CAP - FRONT	COPERCHIO ANTERIORE	COUVERCLE FRONTAL
6	REC13-39107	306470	CIERRE	LOCKWASHER	CHIUSURA	RONDELLE
7	REC317624	552940	TORNILLO	SCREW	VITE	VIS
8	REC11-862903	552938	TUERCA	NUT	DADO	ÉCROU
9	REC13-35048	120177	CIERRE	LOCKWASHER	CHIUSURA	RONDELLE
10	REC16-56826	3852093	PERNO	STUD	PERNO	VIS
11	REC907761	907761	JUNTA TAPA	GASKET - END CAP	GUARNIZIONE	JOINT COUVERCLE
12	BAOMC1-907885	907885	TAPA TRASERA	END CAP - REAR	COPERCHIO POSTERIORE	COUVERCLE ARRIÈRE
13	REC315055	315055	JUNTA CARBURADOR	CARBURETOR GASKET	GUARNIZIONE CARBURATORE	JOINT DE CARBURATEUR
14	REC909371	909371	MANGUITO ESCAPE CODO	EXHAUST HOSE - ELBOW	MANICOTO SCARICO	DURITE D'ÉCHAPPEMENT
15	GS38320	3852604	ABRAZADERA MANGUITO	CLAMP - EXHAUST HOSE	FASCETTA MANICOTTO	COLLIER
16	REC909368	909368	CODO	ELBOW	GOMITO	COUDE
17	REC907764	907764	JUNTA CODO A TAPA	GASKET - ELBOW	GUARNIZIONE	JOINT COUDE À COUVERCLE
18	BAOMC20-980536	980536	CODO ESCAPE	EXHAUST ELBOW ASSEMBLY	GOMITO SCARICO	COUDE D'ÉCHAPPEMENT
19	REC3852142	306422	TUERCA	NUT	DADO	ÉCROU

OMC

RECAMBIOS  
MARINOS

120HP, 4 CYL. 153CID / 2.5L GM (1981-86)

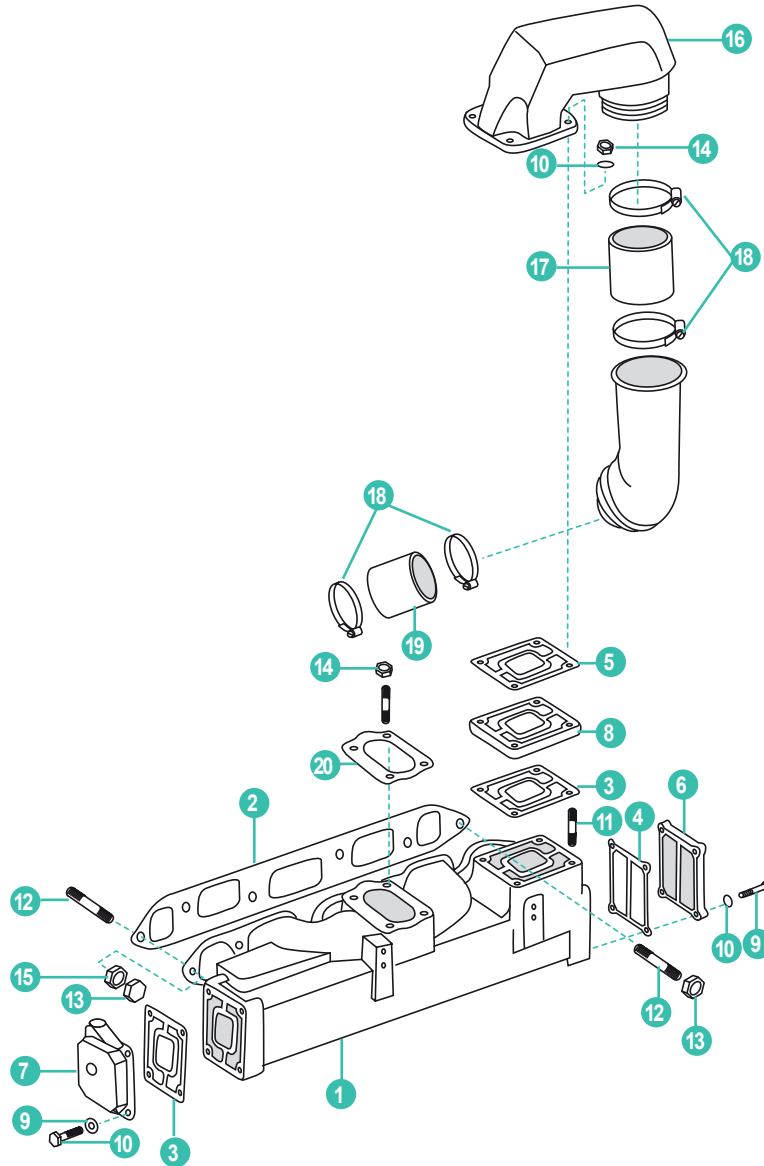

	REF	OEM				
1	BAOMC1-982657	982657	COLECTOR ESCAPE	EXHAUST MANIFOLD ASSEMBLY	COLLETTORE SCARICO	COLLECTEUR D'ÉCHAPPEMENT
2	REC27-52546	311068	JUNTA COLECTOR ESCAPE	GASKET - EXHAUST MANIFOLD	GUARNIZIONE COLLETTORE	JOINT COLLECTEUR
3	REC311121	311121	JUNTA TAPA Y ESPACIADOR	GASKET - END CAP AND SPACER	GUARNIZIONE	JOINT COUVERCLE
4	REC907761	907761	JUNTA TAPA	GASKET - END CAP	GUARNIZIONE	JOINT COUVERCLE
5	REC3850495	3850495	JUNTA CODO ESCAPE	GASKET - EXHAUST ELBOW	GUARNIZIONE SCARICO	JOINT COUDE D'ÉCHAPPEMENT
6	BAOMC1-907885	907885	TAPA TRASERA	END CAP - REAR	COPERCHIO POSTERIORE	COUVERCLE ARRIÈRE
7	BA1-910384	910384	TAPA DELANTERA	END CAP - FRONT	COPERCHIO ANTERIORE	COUVERCLE AVANT
8	BAOMC20-908014	908014	ESPACIADOR	SPACER	DISTANZIALI	ADAPTATEUR POUR COUDE
9	REC317624	552940	TORNILLO	SCREW	VITE	VIS
10	REC13-39107	306470	CIERRE	LOCKWASHER	CHIUSURA	RONDELLE
11	REC910389	910389	PERNO	STUD	PERNO	VIS
12	REC16-56826	120177	PERNO	STUD	PERNO	VIS
13	REC11-862903	552938	TUERCA	NUT	DADO	ÉCROU
14	REC3852142	306422	TUERCA	NUT	DADO	ÉCROU
15	REC13-35048	120177	CIERRE	LOCKWASHER	CHIUSURA	RONDELLE
16	BAOMC20-910380	3850799	CODO ESCAPE	EXHAUST ELBOW ASSEMBLY	GOMITO SCARICO	COUDE D'ÉCHAPPEMENT
17	REC909232	909232	MANGUITO ESCAPE	EXHAUST HOSE	MANICOTO SCARICO	DURITE D'ÉCHAPPEMENT
18	GS38320	3852604	ABRAZADERA	CLAMP	FASCETTA	COLLIER
19	REC909371	909371	MANGUITO ESCAPE	EXHAUST HOSE	MANICOTO SCARICO	DURITE D'ÉCHAPPEMENT
20	REC315055	315055	JUNTA CARBURADOR	GASKET - CARBURATOR	GUARNIZIONE CARBURATORE	JOINT CARBURATEUR

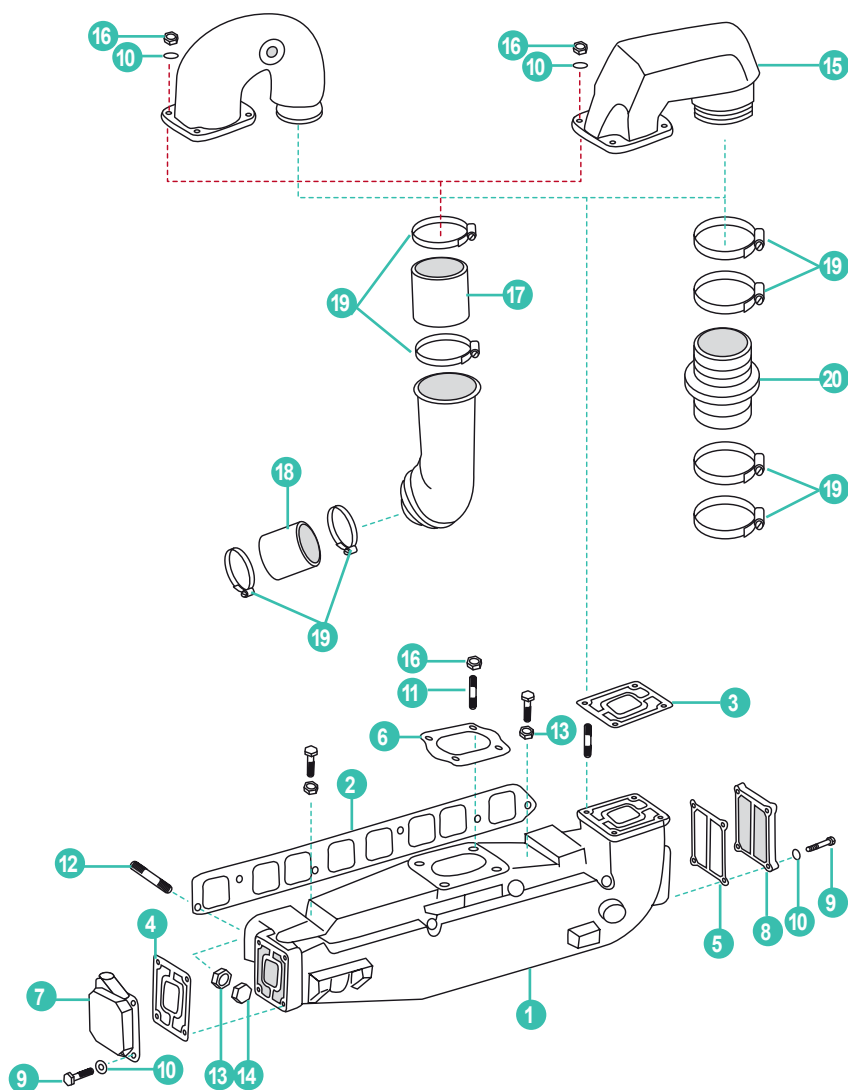

	REF	OEM				
1	BAOMC1-984054	984054	COLECTOR ESCAPE	EXHAUST MANIFOLD ASSEMBLY	COLLETTORE SCARICO	COLLECTEUR D'ÉCHAPPEMENT
2	REC27-53354	908079	JUNTA COLECTOR ESCAPE	GASKET - EXHAUST MANIFOLD	GUARNIZIONE COLLETTORE	JOINT COLLECTEUR
3	REC3850495	3850495	JUNTA CODO	GASKET - EXHAUST ELBOW	GUARNIZIONE GOMITO	JOINT COUDE
4	REC311121	311121	JUNTA TAPA	GASKET - END CAP	GUARNIZIONE COPERCHIO	JOINT COUVERCLE
5	REC907761	907761	JUNTA TAPA	GASKET - END CAP	GUARNIZIONE COPERCHIO	JOINT COUVERCLE
6	REC315055	315055	JUNTA CARBURADOR	GASKET - CARBURETOR	GUARNIZIONE CARBURATORE	JOINT CARBURATEUR
7	BA1-910384	910384	TAPA TRASERA	END CAP - FRONT	GUARNIZIONE POSTERIORE	COUVERCLE ARRIÈRE
8	BAOMC1-907885	907885	TAPA DELANTERA	END CAP - REAR	GUARNIZIONE ANTERIORE	COUVERCLE AVANT
9	REC317624	552940	TORNILLO TAPA	SCREW - END CAP	VIS COPERCHIO	VITE COUVERCLE
10	REC13-39107	306470	CIERRE	LOCKWASHER	CHIUSURA	RONDELLE
11	REC16-70236	314616	PERNO CARBURADOR	STUD - CARBURETOR	PERNO CARBURATORE	VIS CARBURATORE
12	REC16-56826	3852093	PERNO COLECTOR ESCAPE	STUD - EXHAUST MANIFOLD	PERNO COLLETTORE	VIS COLLECTEUR
13	REC13-35048	120177	CIERRE	LOCKWASHER	CHIUSURA	RONDELLE
14	REC11-862903	552938	TUERCA	NUT	DADO	ÉCROU
15	BAOMC20-910380	3850799	CODO ESCAPE	EXHAUST ELBOW ASSEMBLY	GOMITO SCARICO	COUDE D'ÉCHAPPEMENT
16	REC3852142	306422	TUERCA	NUT	DADO	ÉCROU
17	REC909232	909232	MANGUITO ESCAPE	EXHAUST HOSE	MANICOTTO SCARICO	DURITE D'ÉCHAPPEMENT
18	REC909371	909371	MANGUITO ESCAPE	EXHAUST HOSE	MANICOTTO SCARICO	DURITE D'ÉCHAPPEMENT
19	GS38320	3852604	ABRAZADERA	CLAMP	FASCETA	COLLIER
20	REC3863450	3852741	MANGUITO ESCAPE	EXHAUST HOSE	MANICOTTO SCARICO	DURITE D'ÉCHAPPEMENT

### 4.3 / 4.3 H.O. GM 262 CID V6 (1986-90)

Este colector ya no se fabrica. Para sustituirlo utilizar todas las piezas del motor modelo: 4.3GM (1991+)  
 This manifold is obsolete. Parts of the 4.3GM (1991+) must be used to replace it.  
 Kit di trasformazione: qui sotto troverete i pezzi necessari per sostituire il collettore: 4.3 GM (1991+)  
 Ce collecteur n'est plus fabriqué. Pour le remplacer, utilisez toutes les pièces du moteur modèle : 4.3GM (1991+)



### 4.3 GM 262 CID V6 (1991+)

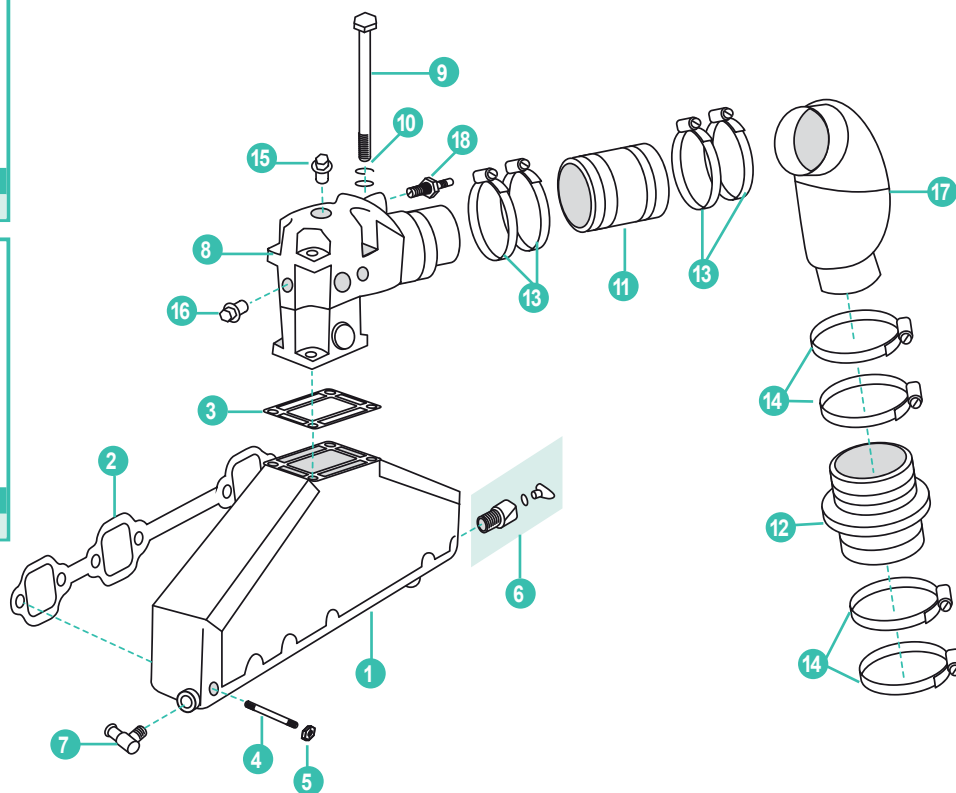
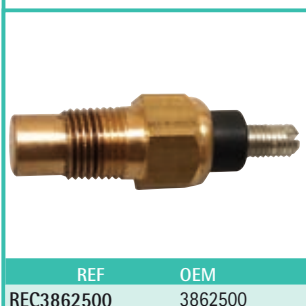

	REF	OEM				
1	MAR499	3847499	COLECTOR ESCAPE	EXHAUST MANIFOLD ASSEMBLY	COLLETTORE SCARICO	COLLECTEUR D'ÉCHAPPEMENT
2	REC27-99757	3853412	JUNTA COLECTOR ESCAPE	GASKET - EXHAUST MANIFOLD	COLLETTORE SCARICO	COLLECTEUR D'ÉCHAPPEMENT
3	REC3863191	351325	JUNTA CODO ESCAPE	GASKET - EXHAUST ELBOW	KIT GUARNIZIONE COLLETTORE SCARICO	KIT COUDE
4	REC3852467	3852467	PERNO	STUD	PERNO	VIS
5	REC46335	3853404	TUERCA	NUT	DADO	ÉCROU
6	REC479956		RACOR COLECTOR	STRAIGHT FITTING	RACCORDO	RACCORD
7	REC3852538	3852538	TORNILLO CODO	ELBOW FITTING	VITE GOMITO	VIS COUDE
8	MAR061	3857944	CODO ESCAPE	EXHAUST ELBOW ASSEMBLY	GOMITO SCARICO	VIS D'ÉCHAPPEMENT
9	REC3852830	3852830	TORNILLO	SCREW	VITE	VIS
10	REC13-35048	120177	CIERRE	LOCKWASHER	CHIUSURA	RONDELLE
11	REC3852696	3852696	MANGUITO ESCAPE	EXHAUST HOSE	MANICOTTO SCARICO	DURITE D'ÉCHAPPEMENT
12	REC3863450	3852741	MANGUITO ESCAPE	EXHAUST HOSE	MANICOTTO SCARICO	DURITE D'ÉCHAPPEMENT
13	GS38322	3853860	ABRAZADERA	CLAMP	FASCETTA	COLLIER
14	GS38320	3852604	ABRAZADERA	CLAMP	FASCETTA	COLLIER
15	REC22-73379		TAPÓN	PLUG	TAPPO	BOUCHON
16	REC22-428611	315713	TAPÓN	PLUG	TAPPO	BOUCHON
17	RM3854874	3854874	CURVA (1991-98) COLA SX	ELBOW SYSTEM DRIVE SX (1991-98)	CURVA (1991-98) PIEDE SX	COUDE SX (1991-98)
18	REC3862500	3862500	SENSOR TEMPERATURA	TEMPERATURE SENSOR	SENSORE TEMPERATURA	CAPTEUR TEMPÉRATURE



800 GM 305/350 CID V8  
 BLOQUE PEQUEÑO | SMALL BLOCK | BLOCCO PICCOLO | BLOQUE PETIT (1979-89)



REF OEM  
 REC18-8553



REF OEM  
 HOT20244-MK

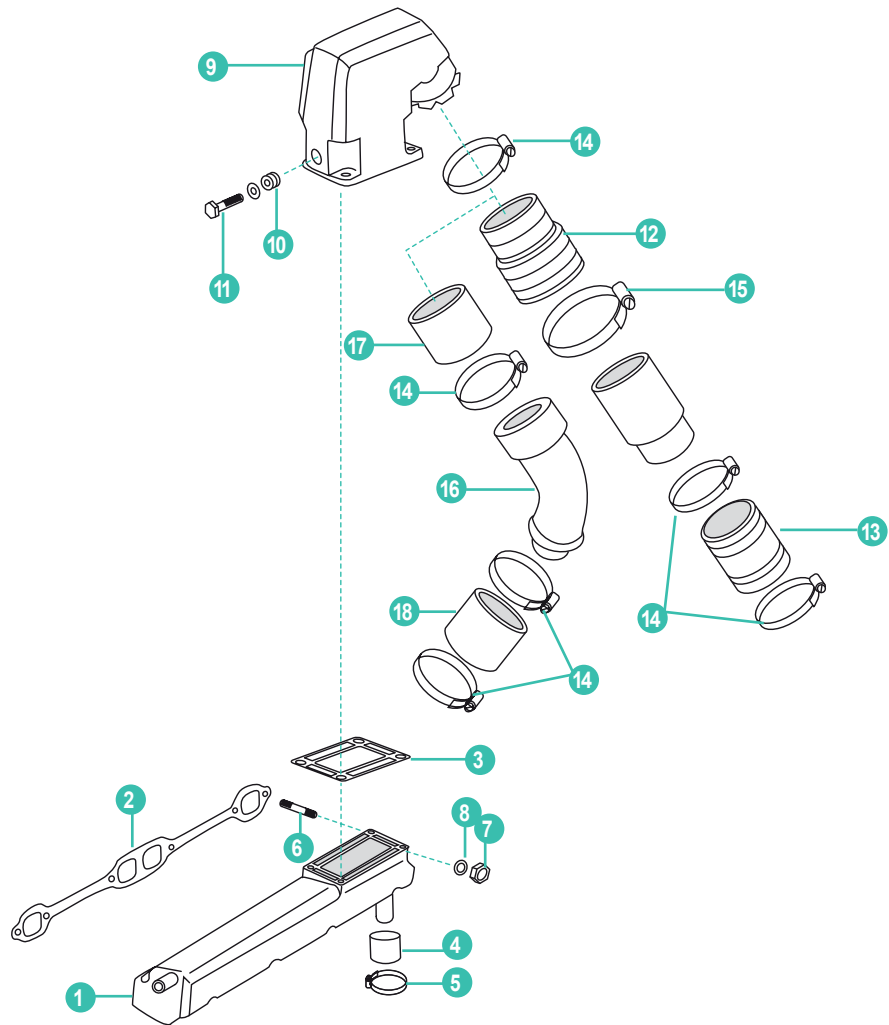

	REF	OEM				
1	HOT20903	912442	COLECTOR ESCAPE BABOR	EXHAUST MANIFOLD ASSEMBLY - PORT	COLLETTORE SCARICO BABORDO	COLLECTEUR D'ÉCHAPPEMENT BABORD
2	REC27-33395	3852468	JUNTA COLECTOR ESCAPE	GASKET - EXHAUST MANIFOLD	GUARNIZIONE COLLETTORE SCARICO	JOINT COLLECTEUR D'ÉCHAPPEMENT
3	REC3863191	3863191	JUNTA CODO ESCAPE	GASKET - EXHAUST ELBOW	GUARNIZIONE GOMITO SCARCIO	JOINT COUDE D'ÉCHAPPEMENT
4	REC764799	764799	TAPA	CAP	COPERCHIO	COUVERCLE
5	REC54-815504320	3853786	ABRAZADERA	CLAMP	FASCETTA	COLLIER
6	REC3852467	3852467	PERNO	STUD	PERNO	VIS
7	REC46335	908700	TUERCA	NUT	DADO	ÉCROU
8	REC13-35048	309336	CIERRE	LOCKWASHER	CHIUSURA	RONDELLE
9	HOT20921	909863	CODO ESCAPE	EXHAUST ELBOW ASSEMBLY	GOMITO SCARICO	COUDE D'ÉCHAPPEMENT
10	REC22-428611	315713	TAPÓN	PLUG	TAPPO	BOUCHON
11	REC13-39107	306325	CIERRE	LOCKWASHER	CHIUSURA	RONDELLE
12	REC912374	912374	MANGUITO ESCAPE (COBRA)	EXHAUST HOSE (COBRA)	MANCIOTTO SCARICO (COBRA)	DURITE D'ÉCHAPPEMENT (COBRA)
13	REC3852742	3852742	MANGUITO ESCAPE (COBRA)	EXHAUST HOSE (COBRA)	MANCIOTTO SCARICO (COBRA)	DURITE D'ÉCHAPPEMENT (COBRA)
14	GS38320	3852604	ABRAZADERA	CLAMP	FASCETTA	COLLIER
15	GS38322	984387	ABRAZADERA	CLAMP	FASCETTA	COLLIER
16	REC909610	909610	TUBO CODO BABOR	ELBOW TUBE - PORT (STRINGER MOUNT)	TUBO GOMITO BABORDO	DURITE COUDE BABORD
17	REC909232	909232	MANGUITO ESCAPE	EXHAUST HOSE	MANICOTTO SCARICO	DURITE D'ÉCHAPPEMENT
18	REC909371	909371	MANGUITO ESCAPE	EXHAUST HOSE	MANICOTTO SCARICO	DURITE D'ÉCHAPPEMENT

5.7L GM 350 CID V8  
(1990+)

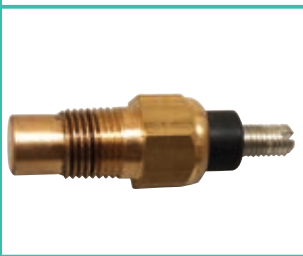

REF	OEM
REC3862500	3862500



REF	OEM
HOT20244-MK	

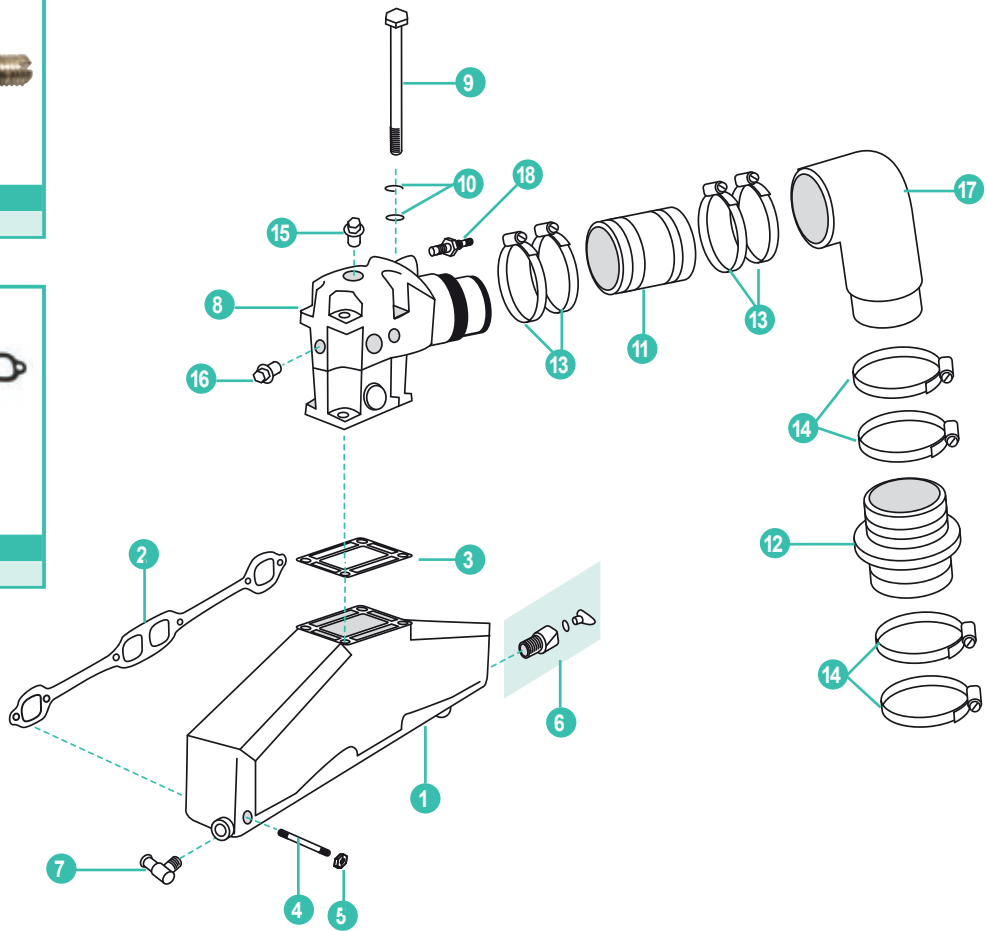

	REF	OEM				
1	MAR501	3857723	COLECTOR ESCAPE	EXHAUST MANIFOLD ASSEMBLY	COLLETORE SCARICO	COLLECTEUR D'ÉCHAPPEMENT
2	REC27-33395	3852468	JUNTA COLECTOR ESCAPE	GASKET - EXHAUST MANIFOLD	GUARNIZIONE COLLETORE SCARICO	JOINT COLLECTEUR D'ÉCHAPPEMENT
3	REC3863191	3863191	JUNTA CODO ESCAPE	GASKET - EXHAUST ELBOW	GUARNIZIONE GOMITO SCARICO	JOINT COUDE D'ÉCHAPPEMENT
4	REC3852467	3852467	PERNO	STUD	PERNO	VIS
5	REC46335	3853404	CIERRE	LOCKNUT	CHIUSURA	RONDELLE
6	REC479956		RACOR COLECTOR	STRAIGHT FITTING KIT	RACCORDO COLLETORE	RACCORD COLLECTEUR
7	REC3852538	3852538	RACOR CODO	ELBOW FITTING	RACCORDO GOMITO	RACCORD COUDE
8	MAR061	3857944	CODO ESCAPE	EXHAUST ELBOW	GOMITO SCARICO	COUDE D'ÉCHAPPEMENT
9	REC3852830	3852830	TORNILLO	SCREW	VITE	VIS
10	REC13-35048	120177 306405	CIERRE	LOCKWASHER	CHIUSURA	RONDELLE
11	REC3852696	3852696	MANGUITO ESCAPE	EXHAUST HOSE	MANICOTTO SCARICO	DURITE D'ÉCHAPPEMENT
12	REC3863450	3852741	MANGUITO ESCAPE	EXHAUST HOSE	MANICOTTO SCARICO	DURITE D'ÉCHAPPEMENT
13	GS38322	3853860	ABRAZADERA	CLAMP	FASCETTA	COLLIER
14	GS38320	3852604	ABRAZADERA	CLAMP	FASCETTA	COLLIER
15	REC22-73379		TAPÓN	PLUG	TAPPO	BOUCHON
16	REC22-428611	315713	TAPÓN	PLUG	TAPPO	BOUCHON
17	REC763891	763891	TUBO ESCAPE	EXHAUST TUBE	TUBO SCARICO	DURITE D'ÉCHAPPEMENT
18	REC3862500	3862500	SENSOR TEMPERATURA	TEMPERATURE SENSOR	SENSORE TEMPERTURA	CAPTEUR TEMPÉRATURE

5.0/5.8L & EFI FORD 302/351 CID V8  
(1991+)

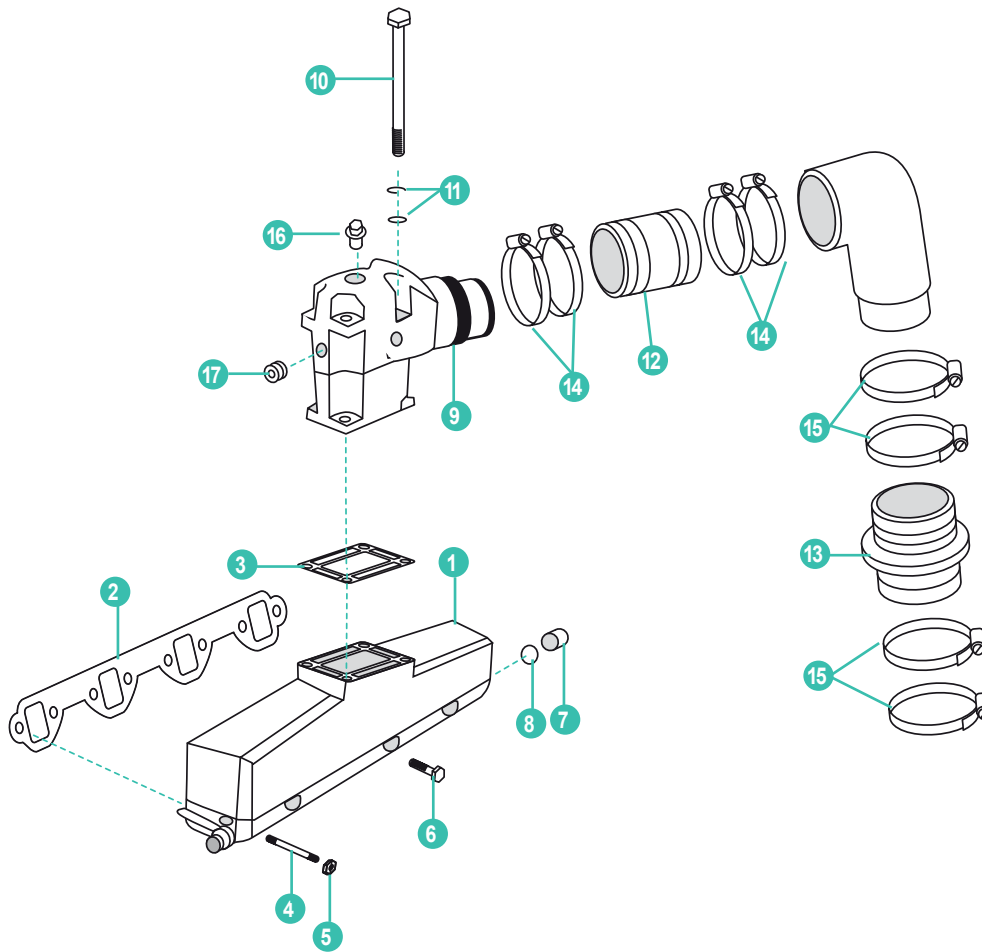

	REF	OEM				
1	BAOMC1-3852347	3852347	COLECTOR ESCAPE	EXHAUST MANIFOLD ASSEMBLY	COLLETTORE SCARICO	COLLECTEUR D'ÉCHAPPEMENT
2	REC3852455	3852455	JUNTA COLECTOR ESCAPE	GASKET - EXHAUST MANIFOLD	GUARNIZIONE COLLETTORE SCARICO	JOINT COLLECTEUR D'ÉCHAPPEMENT
3	REC3863191	3863191	JUNTA CODO ESCAPE	GASKET - EXHAUST ELBOW	GUARNIZIONE GOMITO SCARICO	JOINT COUDE D'ÉCHAPPEMENT
4	REC3853434	3853434	PERNO	STUD	PERNO	VIS
5	REC46335	3853404	TUERCA	NUT	DADO	ÉCROU
6	REC10-37612	3853155	TORNILLO	SCREW	VITE	VIS
7	REC3852476	3852476	TAPA	CAP	COPERCHIO	COUVERCLE
8	REC3852602	912627	ARANDELA	CLAMP	FASCETTA	COLLIER
9	MAR061	3857944	CODO ESCAPE (1988-96) CARB.	EXHAUST ELBOW ASSEMBLY (1988-96 CARB.)	GOMITO SCARICO CARBURATORE (1988-96)	COUDE D'ÉCHAPPEMENT (1988-96) CARB.
9	REC3855271	3855271	CODO ESCAPE BABOR (1993-96) EFI	EXHAUST ELBOW ASSLY - PORT (1993-96 EFI)	GOMITO SCARICO EFI BABORDO (1993-96)	COUDE D'ÉCHAPPEMENT (1993-96) BABORD - EFI
9	REC3855269	3855269	CODO ESCAPE ESTRIBOR (1993-96) EFI	EXHAUST ELBOW ASBLY - STBD (1993-96 EFI)	GOMITO SCARICO EFI TRIBORDO (1993-96)	COUDE D'ÉCHAPPEMENT (1993-96) TRIBORD - EFI
10	REC3852830	3852830	TORNILLO	SCREW	VITE	VIS
11	REC13-35048	120177 306405	CIERRE	LOCKWASHER	CHIUSURA	RONDELLE
12	REC3852696	3852696	MANGUITO ESCAPE	EXHAUST HOSE	MANICOTTO SCARICO	DURITE D'ÉCHAPPEMENT
13	REC3863450	3852741	MANGUITO ESCAPE	EXHAUST HOSE	MANICOTTO SCARICO	DURITE D'ÉCHAPPEMENT
14	GS38322	3853860	ABRAZADERA	CLAMP	FASCETTA	COLLIER
15	GS38320	3852604	ABRAZADERA	CLAMP	FASCETTA	COLLIER
16	REC22-73379		TAPÓN	PLUG	TAPPO	BOUCHON
17	REC22-428611	315713	TAPÓN	PLUG	TAPPO	BOUCHON

7.4/8.2L GM 454/502 CID V8  
(1991+)

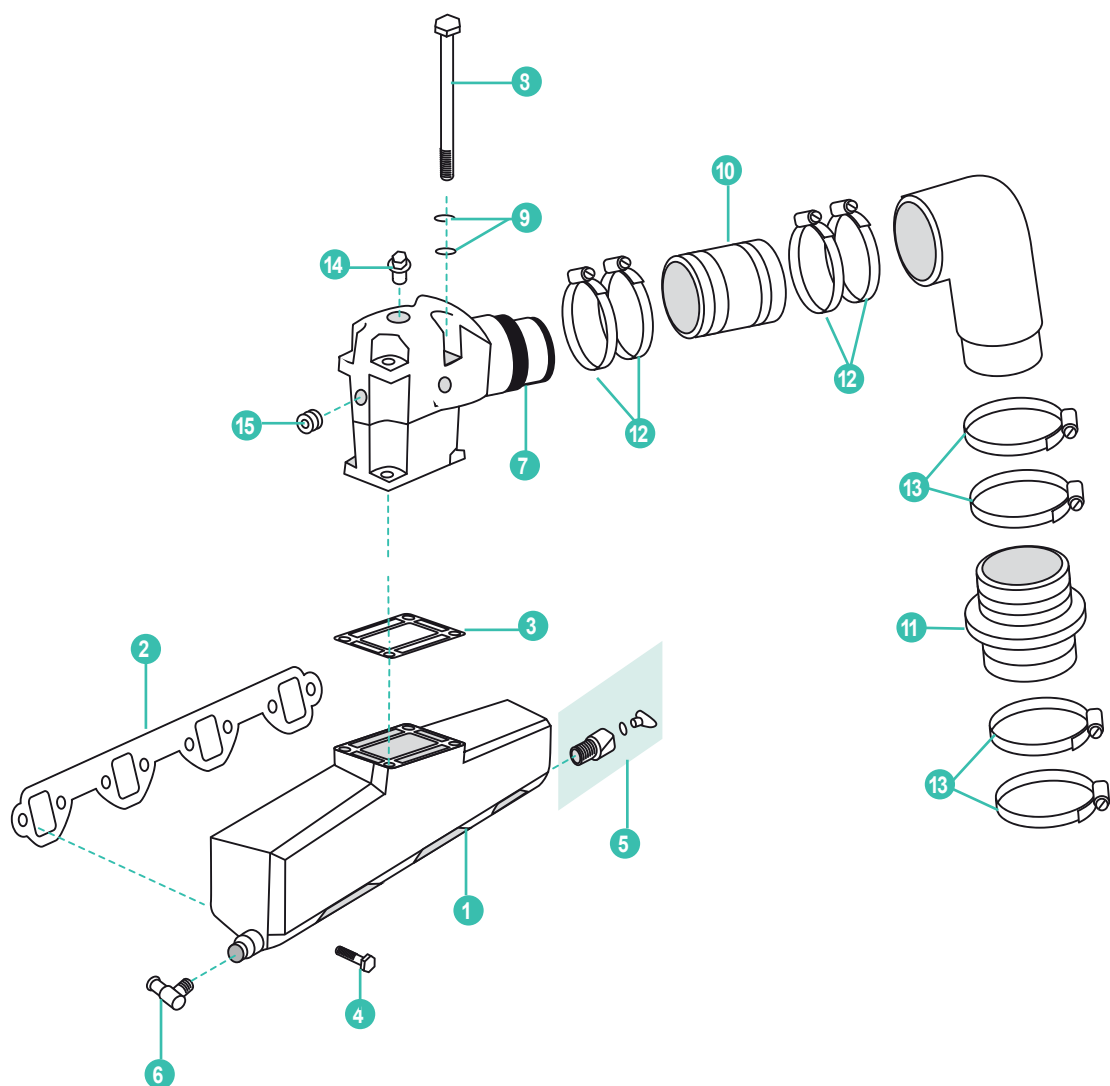

	REF	OEM				
1	RM3861459	3861459	COLECTOR ESCAPE	EXHAUST MANIFOLD ASSEMBLY	COLLETORE SCARICO	COLLECTEUR D'ÉCHAPPEMENT
2	REC27-46820	3852472	JUNTA COLECTOR ESCAPE	GASKET - EXHAUST MANIFOLD	GUARNIZIONE COLLETORE SCARICO	JOINT COLLECTEUR D'ÉCHAPPEMENT
3	REC3863191	3863191	JUNTA CODO ESCAPE	GASKET - EXHAUST ELBOW	GUARNIZIONE GOMITO SCARICO	JOINT COUDE D'ÉCHAPPEMENT
4	REC10-37612	3853326	TORNILLO	SCREW 3/8 - 16 X 1 1/4 FLANGE	PERNO	VIS
5	REC479956		RACOR COLECTOR	STRAIGHT FITTING	RACORDO COLLETORE	RACCORD COLLECTEUR
6	REC3852538	3852538	RACOR CODO	ELBOW FITTING	RACORDO GOMITO	RACCORD COUDE
7	MAR061	3857944	CODO ESCAPE	EXHAUST ELBOW ASSEMBLY	GOMITO SCARICO	COUDE D'ÉCHAPPEMENT
8	REC3852830	3852830	TORNILLO	SCREW	VITE	VIS
9	REC13-35048	120177 306405	CIERRE	LOCKWASHER	CHIUSURA	RONDELLE
10	REC3852696	3852696	MANGUITO ESCAPE	EXHAUST HOSE	MANICOTTO SCARICO	DURITE D'ÉCHAPPEMENT
11	REC3863450	3852741	MANGUITO ESCAPE	EXHAUST HOSE	MANICOTTO SCARICO	DURITE D'ÉCHAPPEMENT
12	GS38322	3853860	ABRAZADERA	CLAMP	FASCETTA	COLLIER
13	GS38320	3852604	ABRAZADERA	CLAMP	FASCETTA	COLLIER
14	REC22-73379		TAPÓN	PLUG	TAPPO	BOUCHON
15	REC22-428611	315713	TAPÓN	PLUG	TAPPO	BOUCHON



**COLECTOR DE ESCAPE**

**EXHAUST MANIFOLD**

REF	OEM	2.3 FORD 4 en línea   4 inline   4 en rete   en ligne
HGE6041	986041	



**COLLETTORE SCARICO**

**COLLECTEUR D'ÉCHAPPEMENT**

REF	OEM	170, 175, 190, 235 HP V8 CID302 Et 351 FORD
BAOMC-1-980959	980959	



**CODOS DE ESCAPE**

**EXHAUST ELBOWS**

REF	OEM	2.3 FORD 4 en línea   4 inline   4 en rete   en ligne
HGE3394	914766	



**GOMITI SCARICO**

**COUDES D'ÉCHAPPEMENT**

REF	OEM	155HP, V6 GM
BAOMC20-981281	981281	



REF	OEM	240HP, 302 Et 351 CID FORD
HOT20921	909863	



REF	OEM	170, 175, 190, 235 HP V8 CID302 Et 351 FORD
BAOMC20-980617	980617	



**JUNTAS COLECTOR DE ESCAPE**

**EXHAUST MANIFOLD GASKET**

REF	OEM	2.3 FORD 4 en línea   4 inline   4 en rete   en ligne
REC913393	913393	



**GUARNIZIONE COLLETTORE DI SCARICO**

**JOINTS COLLECTEUR D'ÉCHAPPEMENT**

REF	OEM	KIT x 2 240HP 302 Et 351 CID FORD 170, 175, 190, 235 HP V8
FEL17460	913393	
REC3852455	3852455	



JUNTAS CODOS		ELBOW GASKET	GUARNIZIONE GOMITO	JOINTS COUDES	
REF	OEM		REF	OEM	
REC878982	912477	2.3 FORD 4 en línea   4 inline   4 en rete   en ligne	REC3863191	913784	240HP, 302 & 351 CID FORD

JUNTAS TAPA		COVER GASKET	GUARNIZIONE COPERCHIO	JOINT COUVERCLE	
REF	OEM		REF	OEM	
BAOMC47-908935	908935	170, 175, 190, 235 HP V8 CID302 & 351 FORD	BAOMC47-311130	311130	155HP V6 GM

TAPÓN DE GOMA		RUBBER CAP	TAPPO IN GOMMA	BOUCHON EN CAOUTCHOUC
REF	OEM			
REC764799	764799			
REC3852476	909829 3852476	240HP, 302 & 351 CID FORD		

TAPA		COVER	COPERCHIO	COUVERCLE	
REF	OEM		REF	OEM	
BA1-908719	908716	170, 175, 190, 235 HP V8 CID302 & 351 FORD	BA1-312148	312148	155HP V6 GM

**BOMBA DE CIRCULACIÓN BLOQUE**

**BLOCK CIRCULATING PUMP**

**POMPA DI RICIRCOLO DI BLOCCO**

**POMPE DE BRASSAGE**

**BOMBAS**

**PUMPS**

**POMPE**

**POMPES**

REF	OEM	
REC46-8M0113733	3858340	GM 4L





REF	OEM	
REC46-8M0113735	3855991	GM V8 (bloque grande   big block   blocco grande   bloque grande)



REF	OEM	
REC46-8M0113734	3853850 985429	GM V6 & V8 (bloque pequeño   small block   blocco piccolo   bloque petit)



REF	OEM	
REC3853796	982517 3471293	Ford 5.0L & 5.8L



**MANGUITO**

**HOSE**

**MANICOTTO**

**DURITE**

REF	OEM	
REC32-33189	312781	COBRA



REF	OEM	
REC32-8M0071007	0509282	



# UNIDADES DE TRANSMISIÓN TRANSMISSION UNIT

# UNITÀ DI TRASMISSIONE EMBASES ET PIÈCES

RECMAR®

ÁNODO

ANODE

ANODI

ANODE

REF	OEM	(kg)	
ZN REC987067	3854061	0,98	COBRA 5700
AL REC987067AL			



REF	OEM	(kg)	
ZN REC986158	3853930	0,61	TRANSOM COBRA (1986-93)
AL REC986158AL			



REF	OEM	(kg)	
ZN REC3851411	3855411	1,04	COBRA (1994-98)
AL REC3863193AL		0,41	



REF	OEM	(kg)	
ZN REC397768	397768	0,31	
AL REC397768AL		0,12	



REF	OEM	(kg)	
ZN REC983494	983494	0,82	400-800 (1978-85)
AL REC983494AL		0,32	



REF	OEM	(kg)	
ZN REC983952	984547	0,91	COBRA
AL REC983952AL	983952	0,35	



REF	OEM	(kg)	
ZN REC976669	976669	0,43	
AL REC976669AL		0,17	



REF	OEM	(kg)	
ZN REC982438	982438	0,83	100-245 HP
AL REC982438AL			



REF	OEM	(kg)	
ZN REC436745	436745	0,22	400-800 (1978-85)
AL REC436745AL		0,09	COBRA (1986-93)



REF	OEM	(kg)	
ZN REC431708	431708	0,27	400-800 (1978-85)
AL REC431708AL		0,24	COBRA (1986-93)



OMC

RECAMBIOS  
MARINOS





**ÁNODO ANODE ANODI ANODE**

REF	OEM	(kg)	
ZN CM984513	3853818	0,97	COBRA (1986-93)
AL CM984513A		0,38	



**KITS DE ÁNODOS ANODES KIT KIT ANODI KIT ANODES**

KIT	ÁNODO ZN ZN ANODE ANODO ZN ANODE ZN	OEM	(kg)	
CMCC			0,93	COBRA
	CMC		0,45	



**UNIDADES DE TRANSMISIÓN UNIT DRIVES UNITÀ DI TRASMISSIONE EMBASES**

**KIT CONVERSIÓN OMC-COBRA CONVERSION KIT OMC-COBRA KIT CONVERSIONE OMC - COBRA KIT CONVERSION OMC - COBRA**

Kit para adaptar las colas Mercruiser a las antiguas unidades OMC-Cobra hasta 300 HP, con el cambio en la unidad inferior. Fácil instalación.

This kit will work on Cobra drives up to 300 HP. Easy to replace the aging Cobra drives with a current style drive that has readily available spare parts.

Kit per adattare i piedi Mercruiser alle vecchie unità OMC-Cobra fino a 300 HP, con il cambio nella unità inferiore. Facile installazione.

Kit pour adapter les embases Mercruiser aux anciennes unités OMC-Cobra jusqu'à 300 CV, avec changement de l'unité inférieure. Installation facile.

REF
REC9D-116

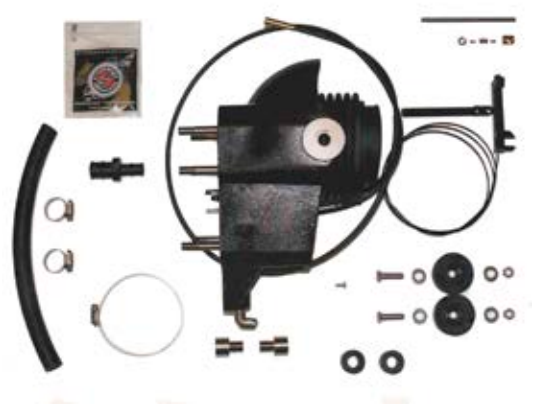

**PARTE INFERIOR COMPLETA COMPLETE GEAR HOUSING ASSEMBLY PARTE INFERIORE COMPLETA PARTIE INFÉRIEURE COMPLETE**

REF	OEM	REDUCCIÓN RATIO RIDUZIONE RÉDUCTION	
REC987800	987800	12:22	3.0, 4.3, 5.0, 5.7 & 5.8L 3.0, 4.3, 5.0, 5.7 & 5.8L

COBRA (1986-93)



OMC

RECAMBIOS MARINOS

COBRA (1986-93)

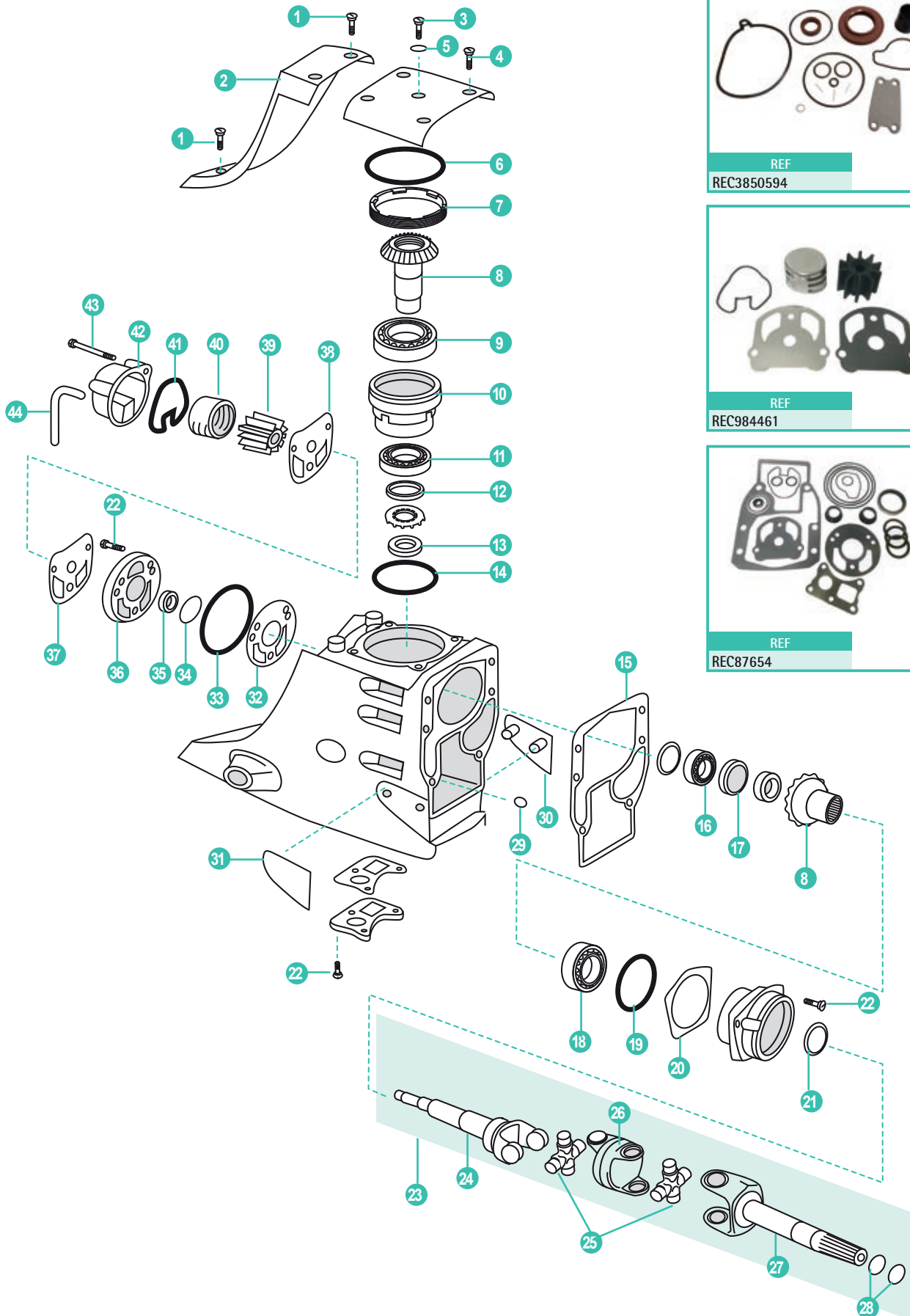

	REF	OEM				
1	REC3852568	3852568	TORNILLO	SCREW	VITE	VIS
2	REC983967	983967	TAPA	COVER ASSY.	COPERCHIO	COUVERCLE
3	REC914488	914488	TORNILLO NIVEL	DIPSTICK	ASTINA	VIS DE VIDANGE
4	REC123018	123018	TORNILLO	SCREW	VITE	VIS
5	REC3852045	303067	ARO TORICO	O-RING	ANELLO	JOINT TORIQUE
6	REC313175	313175	ARO TÓRICO	O-RING	ANELLO	JOINT TORIQUE
7	REC911751	911751	ARANDELA CIERRE	LOCK WASHER	RONDELLA CHIUSURA	RONDELLE FREIN
	REC983825	983825	KIT PIÑONES (21:16) V8	GEAR SET (21:16) V8	KIT PIGNONE (21:16) V8	KIT PIGNONS (21:16) V8
8	REC984012	984012	KIT PIÑONES (21:19) V6	GEAR SET (21:19) V6	KIT PIGNONE (21:19) V6	KIT PIGNONS (21:19) V6
	REC983826	983826	KIT PIÑONES (21:18) V8	GEAR SET (21:18) V8	KIT PIGNONE (21:18) V8	KIT PIGNONS (21:18) V8
9	REC31-35990A1	983891	COJINETE	BEARING	CUSCINETTO	ROULEMENT
10	REC911750	911750	CUERPO COJINETE	BEARING CARRIER	CORPO CUSCINETTO	PALIER DE ROULEMENT
11	REC983892	983892	COJINETE	BEARING	CUSCINETTO	ROULEMENT
12	REC911697	911697	ARANDELA	WASHER	RONDELLA	RONDELLE
13	REC911753	911753	TUERCA PIÑÓN	PINION NUT	DADO	ECROU DE PIGNON
14	REC911668	911668	GRUESO	SHIM 0.010	SPESSORE	CALE
15	REC915840	915840	KIT JUNTAS	GASKET SET	KIT GUARNIZIONE	KIT JOINTS
16	REC983878	983878	COJINETE	BEARING	CUSCINETTO	ROULEMENT
17	REC911937	911937	TUERCA PIÑÓN	U-JOINT NUT	DADO	ÉCROU DE PIGNON
18	REC983877	983877	COJINETE	BEARING	CUSCINETTO	ROULEMENT
19	REC25-70937	911686	ARO TÓRICO	O-RING	ANELLO	JOINT TORIQUE
	REC911678	911678	GRUESO	SHIM 0.003	SPESSORE	CALE
20	REC911679	911679	GRUESO	SHIM 0.004	SPESSORE	CALE
	REC911680	911680	GRUESO	SHIM 0.005	SPESSORE	CALE
	REC911681	911681	GRUESO	SHIM 0.010	SPESSORE	CALE
21	REC911685	911685	RETÉN	OIL SEAL	PARAOLIO	JOINT SPI
22	REC3852454	908668	TORNILLO	SCREW	VITE	VIS
23	REC983880	983880	CARDÁN COMPLETO	U-JOINT & WATER PUMP SHAFT	CARDANO COMPLETO	CARDAN AVEC ARBRE
24	REC984264	984264	EJE BOMBA AGUA	YOKE & WATER PUMP SHAFT	ASSE POMPA ACQUA	ARBRE POMPA D'EAU
25	REC3850812	3850812	CRUCETA CARDAN 1990-93	UNIVERSAL JOINT	CROCETTA CARDANO (1990-93)	CROISILLON (1990-93)
	REC75832T	912214	CRUCETA CARDAN 1986-99	UNIVERSAL JOINT	CROCETTA CARDANO (1986-99)	CROISILLON(1986-99)
26	REC393831	912213	CARDAN	SOCKET	CARDANO	CARDAN
27	REC59830A7	912212	UNIÓN COLA MOTOR	YOKE-DRIVE SHAFT	UNIONE MOTORE	CARDAN
28	REC25-25439	3852565	ARO TÓRICO	O-RING	ANELLO	JOINT TORIQUE
29	RM3852516	910953	ARO RETENEDOR	RETAINER RING	ANELLO FERMO	RONDELLE FREIN
30	REC3589522	3852561	TAPA LATERAL	THRUST PLATE	COPERCHIO LATERALE	COUVERCLE LATERALE
31	REC3589524	3852562	TAPA LATERAL	THRUST PLATE	COPERCHIO LATERALE	COUVERCLE LATERALE
32	REC911698	911698	JUNTA	GASKET	GUARNIZIONE	JOINT
33	REC911700	911700	ARO TÓRICO	O-RING	ANELLO	JOINT TORIQUE
34	REC909316	909316	ARO TÓRICO	O-RING	ANELLO	JOINT TORIQUE
35	REC3853655	3853655	RETÉN	OIL SEAL	PARAOLIO	JOINT SPI
36	REC911699	911699	BASE BOMBA AGUA	WATER PUMP ADAPTER	BASE POMPA ACQUA	BASE POMPE
37	REC802385	911702	JUNTA	GASKET	GUARNIZIONE	JOINT
38	REC911703	911703	TAPA BOMBA AGUA	WEAR PLATE	COPERCHIO POMPA ACQUA	COUVERCLE POMPA
39	REC777128 CEF500317	777128	TURBINA	IMPELLER	GIRANTE	TURBINE
40	REC764197	764197	CASQUILLO CUERPO BOMBA	WATER PUMP LINER	BOCCOLA CORPO POMPA	CAGE DE POMPE A EAU
41	REC911704	911704	RETÉN	OIL SEAL	PARAOLIO	JOINT SPI
42	REC984744	984744	TAPA BOMBA AGUA	PUMP HOUSING	COPERCHIO POMPA ACQUA	COUVERLCE POMPA
43	REC912238	912238	TORNILLO	SCREW	VITE	VIS
44	REC912614	912614	TUBO	VENT HOSE	TUBO	DURITE

## COBRA (1986-93)

Las colas Cobra con motores 3.0L de (1986-89) utilizan una parte inferior de menos diámetro como los motores 2.3L de (1987-90). Las posteriores utilizan la misma parte inferior que los V6 y V8.

The (1986-89) Cobra Sterndrives with four-cylinder 3.0L engines utilize a small diameter lower gear housing. The (1990-93) four-cylinder 3.0L Cobra Sterndrives use the same large diameter lower gear housing as the 1986-1993 V6 and V8 powered Cobra Sterndrives. (1987-90) 2.3L engines use the small gear housing.

I piedi Cobra con motori 3.0L del (1986-89) utilizzano la parte bassa differente ed è più piccola come nei motori 2.3L dal (1987-90), utilizzano la stessa parte inferiore che i V6 e V8.

Les embases de Cobra équipées de moteurs 3.0L (1986-89) ont un alésage inférieur comme les moteurs 2.3L (1987-90). Les modèles ultérieurs utilisent le même bloc moteur que les V6 et V8.

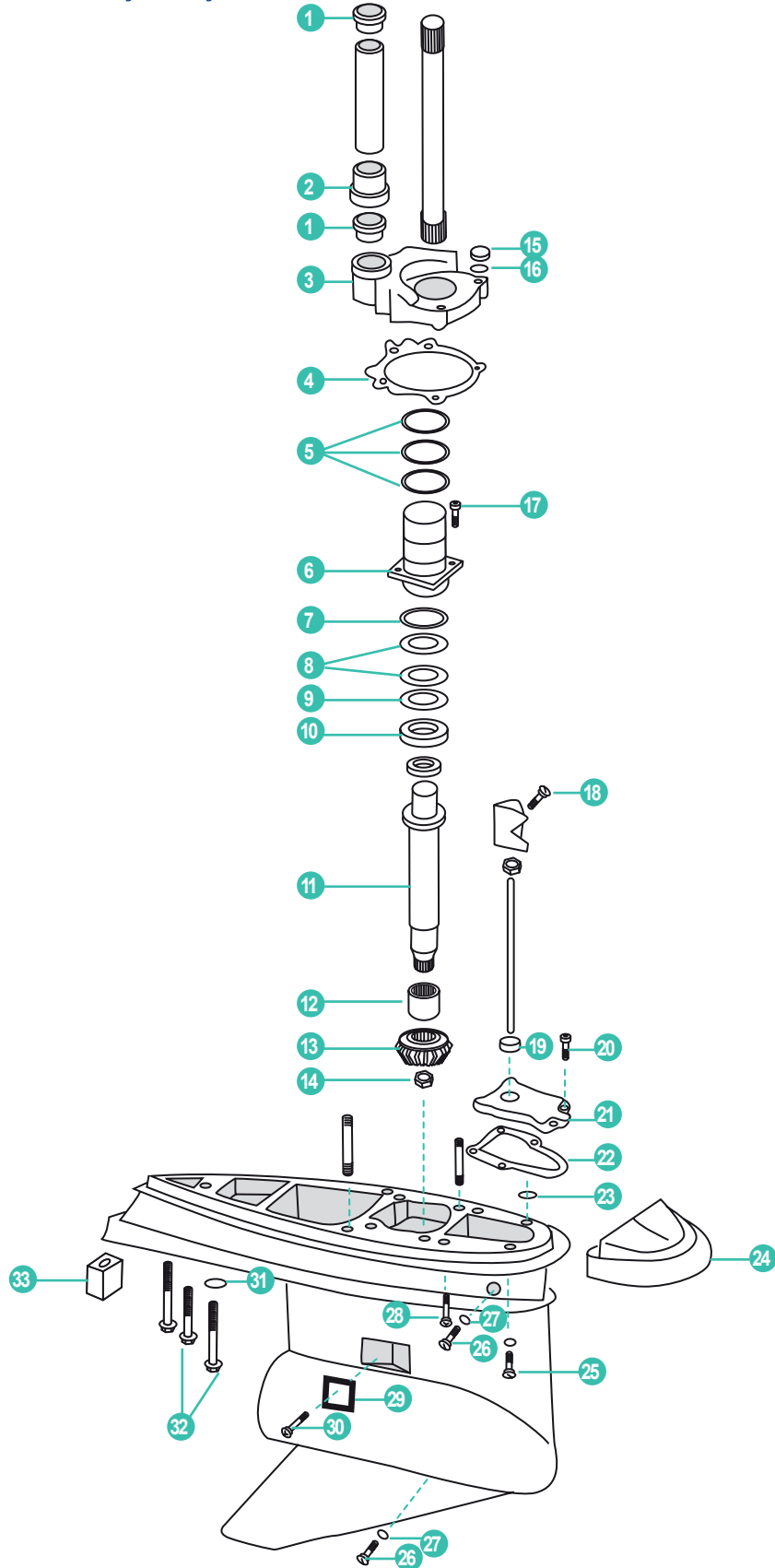



	REF	OEM				
1	REC911705	911705	RETÉN	SEAL	PARAOLIO	JOINT SPI
2	REC911715	911715	GUÍA TUBO	GUIDE	GUIDA TUBO	GUIDE
3	REC915720	915720	TAPA GUÍA TUBO	WASHER	COPERCHIO GUIDA TUBO	COUVERCLE GUIDE
4	REC915719	915719	JUNTA	GASKET	GUARNIZIONE	JOINT
5	REC318717	318717	ARO TÓRICO	O-RING	ANELLO	JOINT SPI
6	REC984462	984462	CUERPO COJINETE	BEARING HNG	CORPO CUSCINETTO	PALIER DE ROULEMENT
7	REC314728	314728	ARO TÓRICO	O-RING	ANELLO	JOINT SPI
	REC323362	323362	SUPLEMENTO .003	SHIM	SPESSORE	CALE .003
8	REC323361	323361	SUPLEMENTO .004	SHIM	SPESSORE	CALE .004
	REC314745	314745	SUPLEMENTO .005	SHIM	SPESSORE	CALE .005
9	REC327656	327656	ARANDELA TOPE	THRUST WASHER	RONDELLA	RONDELLE FREIN
10	REC387656	387656	TOPE COJINETE	THRUST BEARING	FERMO CUSCINETTO	ROULEMENT
11	REC764197	764197	CASQUILLO CUERPO BOMBA	WATER PUMP LINER	BOCCOLA CORPO POMPA	CAGE DE POMPE A EAU
	REC984744	984744	TAPA BOMBA AGUA	PUMP HOUSING	COPERCHIO POMPA ACQUA	COUVERLCE POMPA
12	REC912238	912238	TORNILLO	SCREW	VITE	VIS
	REC912614	912614	TUBO	VENT HOSE	TUBO	DURITE
13	REC986979	986979	KIT PIÑONES 4 L (1986-93)	GEAR SET 4L (1986-93)	KIT PIGNONE 4L (1986-93)	KIT PIGNONES 4L (1986-93)
14	REC11-35921	314730	TUERCA	NUT	DADO	ÉCROU
15	REC11-8267089	121731	TAPÓN	NUT	TAPPO	BOUCHON
16	PAGB/T848-6	305981	ARANDELA	WASHER	RONDELLA	RONDELLE
17	REC317624	317624	TORNILLO	SCREW	VITE	VIS
18	REC308825	308825	TORNILLO	SCREW	VITE	VIS
19	REC912157	912157	CASQUILLO	WIPER	BOCCOLA	BAGUE
20	REC304027	304027	TORNILLO	SCREW	VITE	VIS
21	REC986838	986838	TAPA CON RETÉN	COVER Et SEAL	TAPPO CON PARAOLIO	COUVERCLE AVEC JOINT
22	REC911878	911878	JUNTA	GASKET	GUARNIZIONE	JOINT
23	REC318372	318372	ARO TÓRICO	O-RING	ANELLO	JOINT TORIQUE
24	CM984513	3853818	ANODO	ANODE	ANODO	ANODE
25	REC912127	912127	TORNILLO	SCREW	VITE	VIS
26	REC22-67892A05	318544	TORNILLO	SCREW	VIRE	VIS
27	REC3855081	311598	ARO TÓRICO	O-RING	ANELLO	JOINT OTRIQUE
28	REC331999	331999	TORNILLO	SCREW	VITE	VIS
29	REC337778	337778	REJILLA	SCREEN	GRIGLIA	GRILLE
30	REC337061	337061	TORNILLO	SCREW	VITE	VIS
31	REC330265	330265	ARANDELA	O-RING	RONDELLA	RONDELLE
32	REC328096	328096	TORNILLO	SCREW	VITE	VIS
33	CM393023	436745	ANODO	ANODE	ANODO	ANODE

COBRA (1986-93)

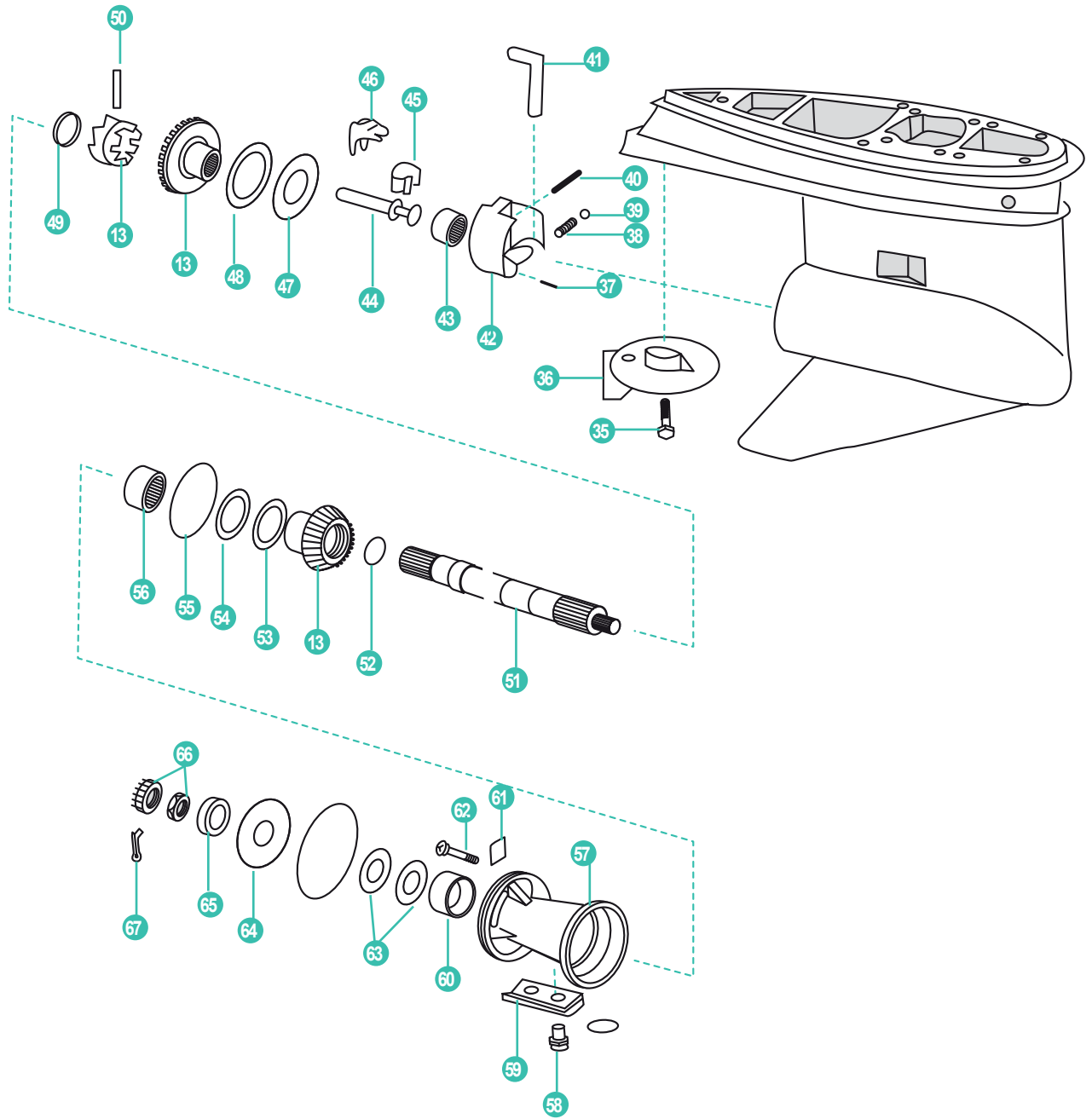

REF		
REC439967	439967 984458	3.0L (1990-93), V6 / V8 (1986-93) KING COBRA

REF		
REC985612	985612	4 Cyl (1986-89), 2.3 L (1987-90)

	REF	OEM			
13	REC5004218	986980	KIT PIÑONES V6-V8 (1986-93)	GEAR SET V6-V8 (1986-93)	KIT PIGNONE V6-V8 (1986-93)
	REC986979	986979	KIT PIÑONES 4 L (1986-93)	GEAR SET 4L (1986-93)	KIT PIGNONE 4L (1986-93)
35	REC313715	313715	TORNILLO	SCREW	VITE
36	TEN00712	912392	ALETA	TRIM TAB	TRIM TAB
37	REC331880	331880	PASADOR	PIN	CHIAVISTELLO
38	REC911962	385367	MUELLE	SPRING	MOLLA
39	REC160084	160084	BOLA	DETENT BALL	BOLLA
40	REC328825	328825	PASADOR	PIN	SPINOTTO
41	REC915954	915954	EJE VARILLA CAMBIO	DETENT	ASTICELLA CAMBIO
42	REC389455	389455	TAPA COJINETE	HOUSING & BEARING ASSY.	COPERCHIO CUSCINETTO
43	REC389039	389039	COJINETE	BEARING	CUSCINETTO
	REC382407	382407	COJINETE GM 4L	BEARING	CUSCINETTO GM 4L
44	REC322941	322941	EJE DESPLAZABLE	SHAFT	ASSE SELETTORE
45	REC334163	334163	REGULADOR EJE	CRADLE	REGOLATORE ASSE
46	REC322938	322938	UÑA DESPLAZABLE	LEVER	LEVA
47	REC327669	327669	TOPE ARANDELA	THRUST WASHER	RONDELLA
	REC324766	324766	TOPE ARANDELA GM 4L	THRUST WASHER	RONDELLA GM 4L
48	REC389042	389042	TOPE COJINETE	THRUST BRING	RONDELLA
	REC385043	385043	TOPE COJINETE GM 4L	GM 4L T B	RONDELLA GM 4L
49	REC324369	324369	MUELLE	SPRING	MOLLA
50	REC313448	313448	PASADOR DESPLAZABLE	CROSS PIN	CHIAVISTELLO
	REC395209	395209	EJE (1986-90) Ø1-3/16	PROP SHAFT 1-3/16 Ø (1986-90)	ASSE (1986-90) Ø1-3/16
51	REC5004765	5004765	EJE (1991-93) Ø1-1/4	PROP SHAFT 1-1/4 Ø (1991-93)	ASSE (1991-93) Ø1-1/4
	REC436888	436888	EJE HÉLICE GM 4L	PROP SHAFT GM 4L	ASSE ELICA GM 4L
52	REC336565	336565	ARANDELA	THRUST WASHER	RONDELLA
53	REC382408	382408	TOPE COJINETE	THRUST BEARING	RONDELLA CUSCINETO
54	REC314731	314731	TOPE ARANDELA	THRUST WASHER	RONDELLA
55	REC967344	313446	ARO TÓRICO	O-RING	ANELLO
56	REC382407	382407	COJINETE	BEARING	CUSCINETTO
57	REC5000074	5000074	COJINETE DIÁBOLO 1986-90)	BEARING CARRIER	CUSCINETTO DIAVOLO (1986-90)
	REC5004257	5004257	COJINETE DIÁBOLO (1991-93)	BEARING CARRIER	CUSCINETTO DIAVOLO (1991-93)
58	REC908158	908158	TORNILLO	SCREW	VITE
59	CM431708	431708	ANODO	ANODE	ANODO
	REC387247	387247	COJINETE (1986-90)	BEARING (1986-90)	CUSCINETTO (1986-90)
60	REC434467	434467	COJINETE (1991-93)	BEARING (1991-93)	CUSCINETTO (1991-93)
	REC379504	379504	COJINETE GM 4L	BEARING	CUSCINETTO GM 4L
61	REC333957	333957	PESTAÑA SUJECCIÓN	TAB	PIASTRA SUPORTO
62	REC350271	350271	TORNILLO	SCREW	BULLONE
63	REC334950	334950	RETÉN (1986-90)	OIL SEAL (1986-90)	PARAOLIO (1986-90)
	REC330137	330137	RETÉN (1991-93)	OIL SEAL (1991-93)	PARAOLIO (1991-93)
64	REC126870	126870	TOPE ARANDELA	THRUST WASHER	RONDELLA
65	REC320570	320570	TOPE HÉLICE	SPACER	SPESSORE
66	REC398042	5008966	KIT TUERCA HÉLICE	NUT & KEEPER	KIT DADO ELICA
67	REC3852056	306394	PASADOR	COTTER PIN	CHIAVISTELLO

COBRA (1994-98)



REF  
REC39631

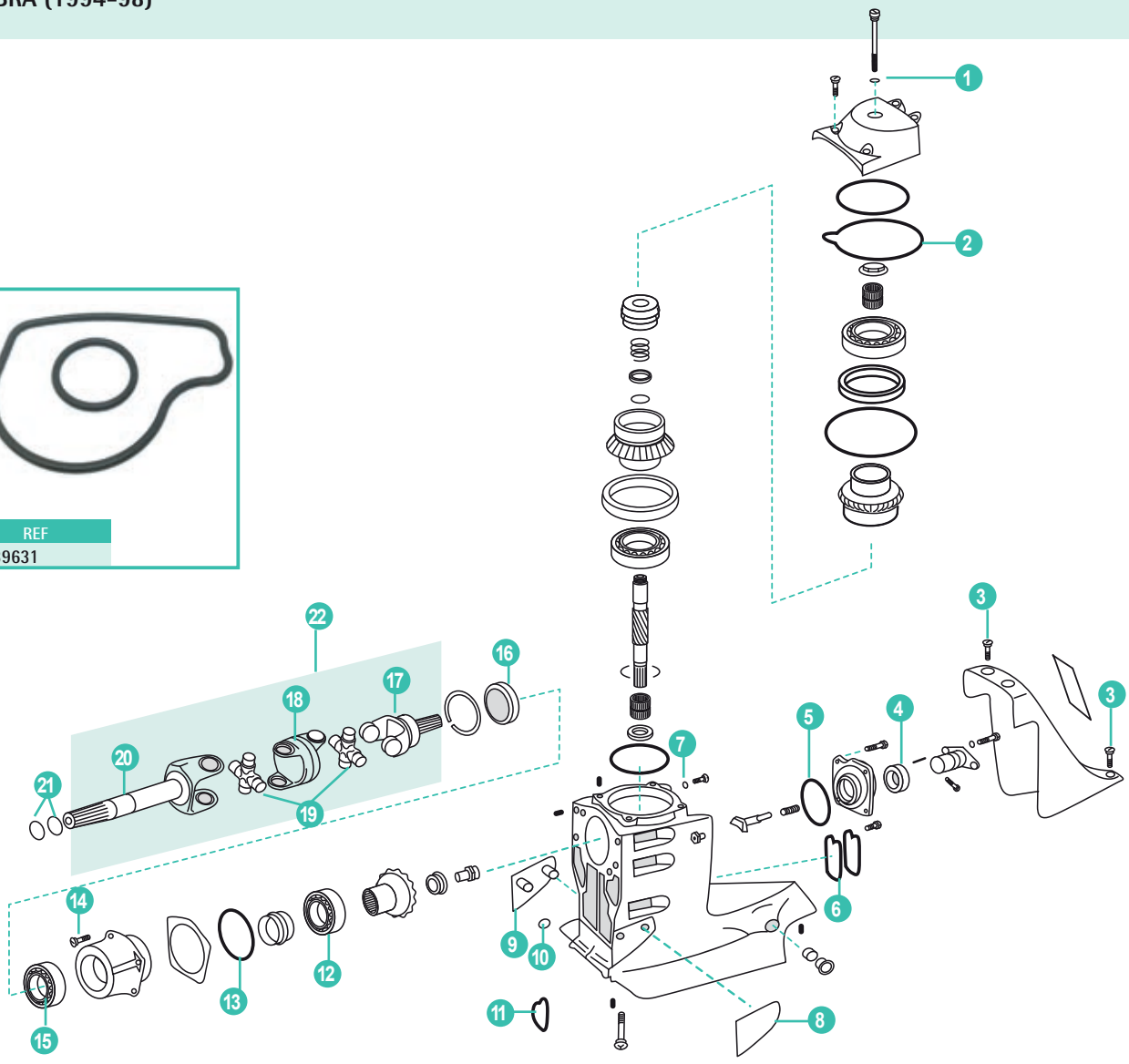

	REF	OEM				
1	REC3852045	303067	ARANDELA	O-RING	RONDELLA	RONDELLE
2	REC3852317	3852317	JUNTA	GASKET	GUARNIZIONE	JOINT
3	REC3852568	3852568	TORNILLO	SCREW	VITE	VIS
4	REC853868	853858	RETEN ACEITE	OIL SEAL	PARAOLIO	POINT SPI
5	REC925093	925093	ARANDELA	O-RING	RONDELLA	RONDELLE
6	REC3852279	3852279	JUNTA	GASKET	GUARNIZIONE	JOINT
7	REC3855081	333572	JUNTA	GASKET	GUARNIZIONE	JOINT
8	REC3589522	3852561	TAPA	THRUST PLATE	COPERCHIO	COUVERCLE
9	REC3589524	3852562	TAPA	THRUST PLATE	COPERCHIO	COUVERCLE
10	REC3852165	910953	ARO RETENEDOR	RETAINING RING	TENUTA	JOINT TORIQUE
11	REC3852560	3852560	RETEN	SEAL	TENUTA	JOINT TORIQUE
12	REC3850852	3850852	COJINETE	BEARING	CUSCINETTO	ROULEMENT
13	REC967344	3852308	ARANDELA	O-RING	RONDELLA	RONDELLE
14	REC3852454	908668	TORNILLO	SCREW	VITE	VIS
15	REC183247	3850853	COJINETE	BEARING	CUSCINETTO	ROULEMENT
16	REC3852272	3852272	RETEN ACEITE	OIL SEAL	PARAOLIO	JOINT SPI
17	REC3850814	3850814	EJE CORTO CARDAN	YOKE	ASSE CORTO CARDANO	ARBRE
18	REC393831	912213	CARDAN	SOCKET	CARDANO	CARDAN
19	REC3850812	3850812	CRUCETA CARDAN	U-JOINT	CROCETTA CARDANO	CROISILLON
20	REC59830A7	912212	UNION COLA MOTOR	YOKE-LONG	UNION COLA MOTORE	CARDAN
21	REC25-25439	3852565	ARANDELA	O-RING	RONDELLA	RONDELLE
22	REC3860842	3860842	TRANSMISIÓN	U-JOINT ASSY	TRAMMISSIONE	CARDAN AVEC ARBRE



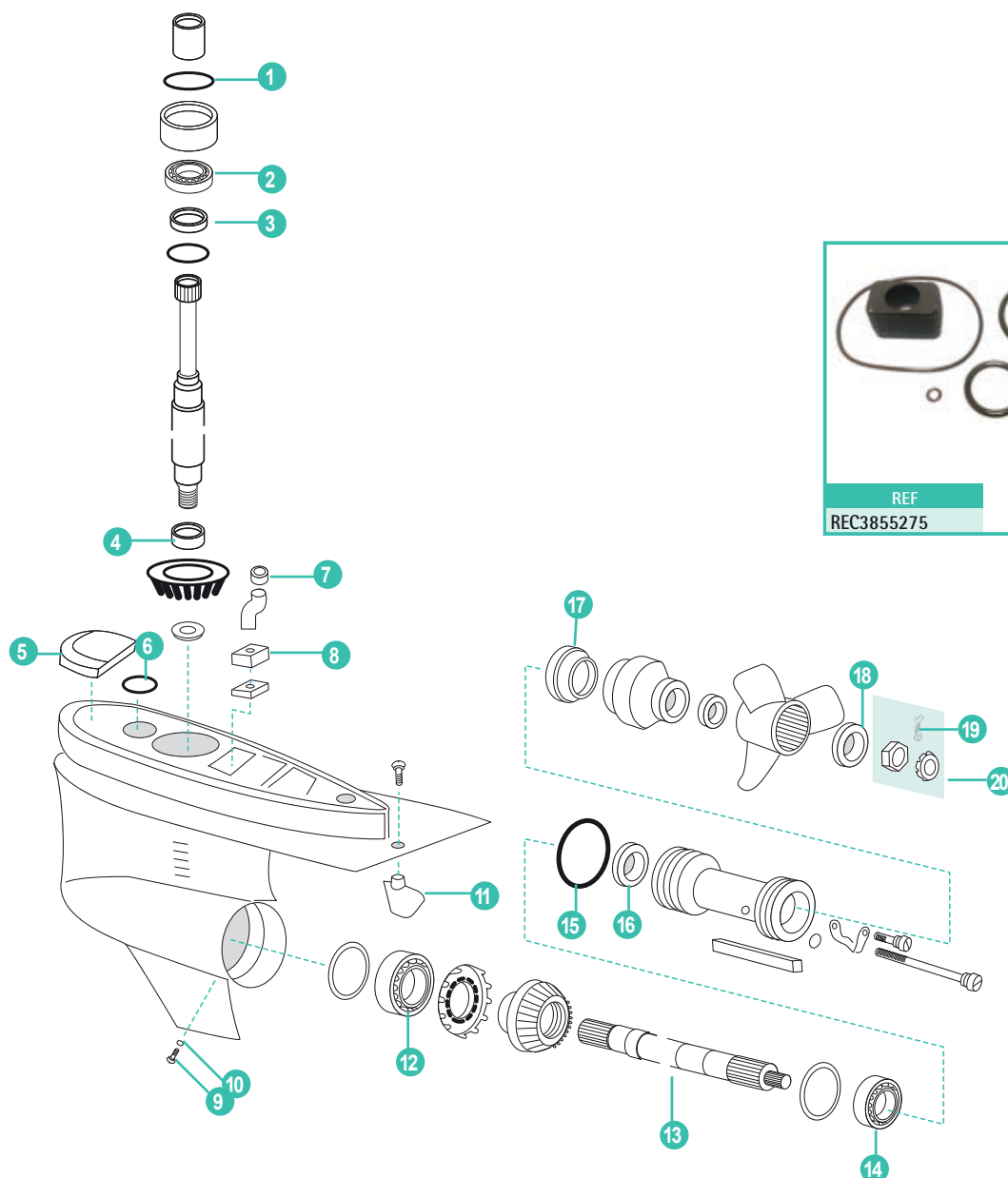

	REF	OEM				
1	REC3852866	3852866	ARO	O-RING	ANELLO	JOINT SPI
2	REC31-86748A1	3854250	COJINETE	BEARING	CUSCINETTO	ROULEMENT
3	REC31-66668A1	3854249	COJINETE	BEARING	CUSCINETTO	ROULEMENT
4	REC3853934	3853934	COJINETE	BEARING	CUSCINETTO	ROULEMENT
5	CM3855411	3855411	ANODO	ANODE	ANODO	ANODE
6	REC3852959	3852959	ARO	O-RING	ANELLO	JOINT TORIQUE
7	REC3852315	3852315	SUPLEMENTO	GROMMET	SPESSORE	CALE
8	REC3854595	3854595	RETÉN	SEAL	TENUTA	JOINT SPI
9	REC22-67892A05	3854539	TORNILLO	SCREW	VITE	VIS
10	REC3855081	333572	ARANDELA	WASHER	RONDELLA	RONDELLE
11	REC854040	3854402	TIMON COLA	TRIM TAB	TIMONE PIEDE	ANODE
12	REC3850942	3850942	COJINETE	BEARING	CUSCINETTO	ROULEMENT
13	REC3857675	3857675	EJE HÉLICE	PROP SHAFT	ASSE ELICA	ARBRE HÉLICE
14	REC31-66668A1	3854249	COJINETE	BEARING	CUSCINETTO	ROULEMENT
15	REC3852865	3852865	ARO	O-RING	ANELLO	JOINT TORIQUE
16	REC3863090	3863090	RETÉN ACEITE	OIL SEAL	PARAOILIO	JOINT SPI
17	REC126870	126870	CIERRE HÉLICE	THRUST WASHER	CHIUSURA ELICA	RONDELLE FREIN
18	REC3852350	3852350	ESPACIADOR	SPACER	DISTANZIALE	CALE
19	REC3852056	306394	PASADOR	COTTER PIN	CHIAVISTELLO	GOUPILLE
20	REC398042	5008966	KIT TUERCA HÉLICE	NUT & KEEPER	KIT DADO	KIT ÉCROU D'HÉLICE

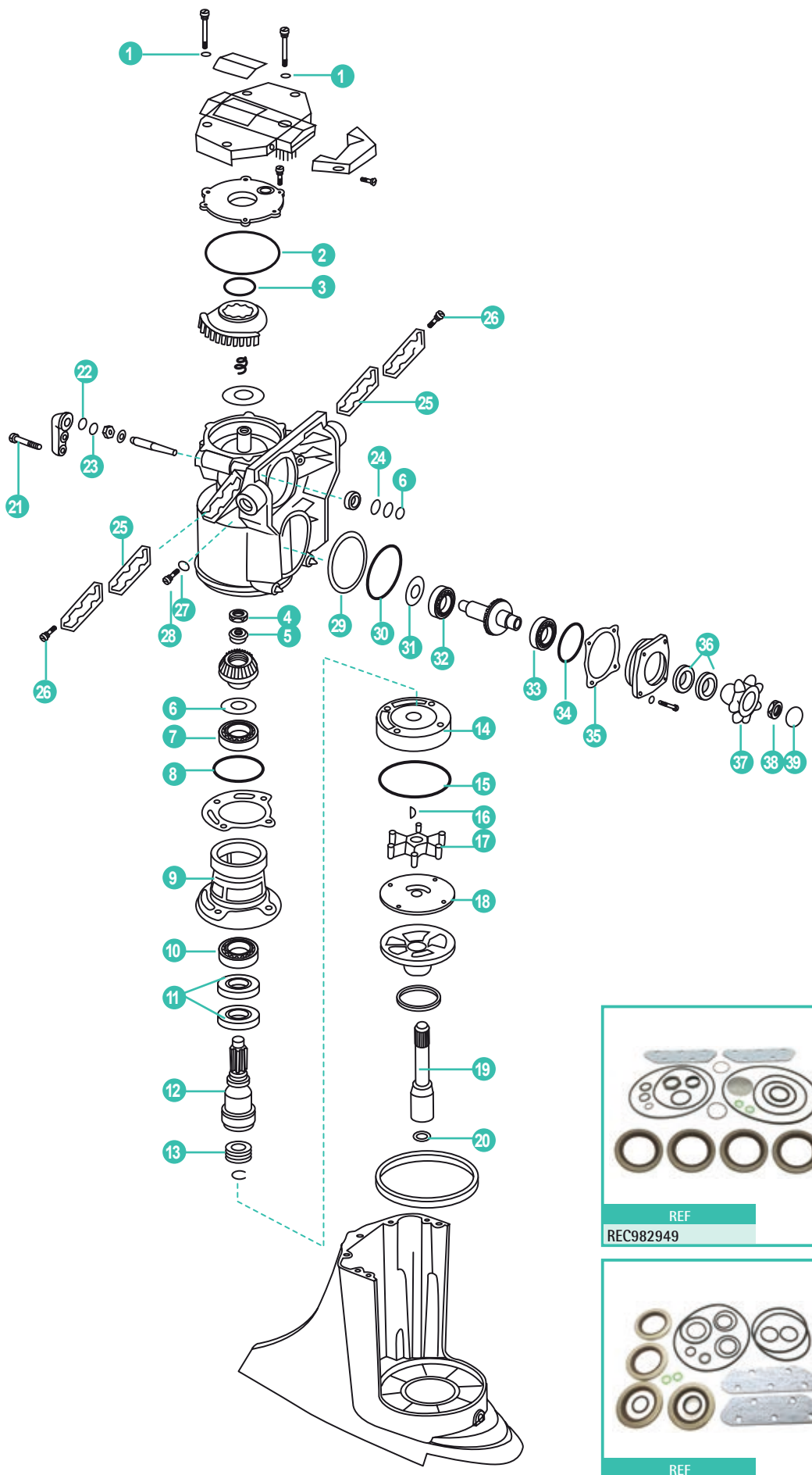

	REF	OEM				
1	REC315189	315189	JUNTA	GASKET	GUARNIZIONE	JOINT
2	REC313175	313175	ANILLO GOMA	O-RING	ANELLO IN GOMMA	JOINT EN CAOUTCHOUC
3	REC25-30224	310327	ANILLO GOMA (CAMBIO ELÉCTRICO)	O-RING (ELECTRIC SHIFT)	ANELLO IN GOMMA (CAMBIO ELETTRICO)	JOINT EN CAOUTCHOUC (CHANGEMENT ELECTRIQUE)
	REC25-30224	910582	ANILLO GOMA (400-800)	O-RING	ANELLO IN GOMMA (400-800)	JOINT EN CAOUTCHOUC (400-800)
4	REC907866	907866	CONTRATUERCA	LOCK NUT	CONTRO DADO	ÉCROU
5	REC909123	909123	TOPE PIÑÓN	CENTERING CONE	FERMO PIGNONE	CONE DE CENTRAGE
6	REC313194	313193	SUPLEMENTO A .003	SHIM .003	SPESSORE .003	CALE .003
	REC313194	313194	SUPLEMENTO A .004	SHIM .004	SPESSORE .004	CALE .004
	REC313195	313195	SUPLEMENTO A .005	SHIM .005	SPESSORE .005	CALE .005
	REC313196	313196	SUPLEMENTO A .006	SHIM .006	SPESSORE .006	CALE .006
	REC313197	313197	SUPLEMENTO A .007	SHIM .007	SPESSORE .007	CALE .007
	REC313198	313198	SUPLEMENTO A .008	SHIM .008	SPESSORE .008	CALE .008
	REC313199	313199	SUPLEMENTO A .009	SHIM .009	SPESSORE .009	CALE .009
	REC313200	313200	SUPLEMENTO A .010	SHIM .010	SPESSORE .010	CALE .010
7	REC379585	379585	COJINETES	BEARING	CUSCINETTO	ROULEMENT
8	REC553126	553126	ANILLO GOMA	O-RING	ANELLO IN GOMMA	JOINT EN CAOUTCHOUC
9	REC910240	910240	TAPA	BEARING HOUSING	COPERCHIO	COUVERCLE
10	REC382165	382165	COJINETE	BEARING	CUSCINETTO	ROULEMENT
11	REC981268	981268	RETÉN	OIL SEAL	PARAOLIO	JOINT SPI
12	REC909121	909121	EJE TRANSMISIÓN	DRIVE SHAFT	ASSE TRASMISSIONE	ARBRE TRANSMISSION
	REC981220	981220	EJE TRANSMISIÓN	DRIVE SHAFT	ASSE TRASMISSIONE	ARBRE TRANSMISSION
	REC382883	382883	EJE TRANSMISIÓN	DRIVE SHAFT	ASSE TRASMISSIONE	ARBRE TRANSMISSION
13	REC907774	907774	RETÉN EJE	SHAFT SEAL	TENUTA ASSE	JOINT D'HUILE ARBRE
14	REC983298	983298	CUERPO BOMBA AGUA	PUMP HOUSING	CORPO POMPA ACQUA	CORPS DE POMPE A EAU
15	REC910238	910238	ANILLO GOMA	O-RING	ANELLO	JOINT TORIQUE
16	REC308928	308924	CHAVETA	KEY	CHIAVETTA	CLAVETTE
17	REC777130	777130	IMPULSOR	IMPELLER	GIRANTE	TURBINE
18	REC313176	313176	TAPA BOMBA AGUA	PUMP PLATE	COPERCHIO POMPA ACQUA	COUVERCLE POMPA D'EAU
19	REC909753	909753	EJE CORTO BOMBA	SHORT DRIVE SHAFT	ASSE CORTO POMPA	ARBRE DE TRANSMISSION COURT
	REC908087	908087	EJE LARGO BOMBA	LONG DRIVE SHAFT	ASSE LUNGO POMPA	ARBRE DE TRANSMISSION LONG
20	REC314491	314491	ANILLO GOMA	O-RING	ANELLO	JOINT TORIQUE
21	REC305282	305282	TORNILLO	SCREW	VITE	VIS
22	REC125017	302540	ANILLO GOMA (ANTIGUO)	O-RING (EARLY MODEL)	ANELLO IN GOMMA (VECCHIO)	JOINT EN CAOUTCHOUC (ANCIEN)
	REC909140	909140	ANILLO GOMA (MODERNO)	O-RING (LATE MODEL)	ANELLO IN GOMMA (MODERNO)	JOINT EN CAOUTCHOUC (MODERNE)
23	REC909139	909139	RETÉN	QUAD RING	PARAOLIO	JOINT SPI
24	REC909048	909048	RETÉN	QUAD RING	PARAOLIO	JOINT SPI
25	REC308592	308592	JUNTA	GASKET	GUARNIZIONE	JOINT
26	REC328694	3852473	TORNILLO	SCREW	VITE	VIS
27	REC3855081	311598	JUNTA	GASKET	GUARNIZIONE	JOINT
28	REC22-67892A05	318544	JUEGO TORNILLOS	SCREW SET	KIT VITI	KIT VIS
29	REC308768	308768	RETÉN	SEAL	TENUTA	JOINT D'HUILE
30	REC308590	308590	MUELLE	SPRING	MOLLA	RESSORT
31	REC313163	313163	SUPLEMENTO A .003	SHIM	SPESSORE .003	CALE .003
	REC313164	313164	SUPLEMENTO A .004	SHIM	SPESSORE .004	CALE .004
	REC313167	313167	SUPLEMENTO A .007	SHIM	SPESSORE .007	CALE .007
32	REC375761	375761	COJINETE	BEARING	CUSCINETTO	ROULEMENT
33	REC382212	382212	COJINETES	BEARING	CUSCINETTO	ROULEMENT
34	REC25-35029	308621	ANILLO RETÉN	O-RING	ANELLO	JOINT D'HUILE
	REC313202	313202	SUPLEMENTO A .002	SHIM	SPESSORE .002	CALE .002
	REC313203	313203	SUPLEMENTO A .003	SHIM	SPESSORE .003	CALE .003
	REC313204	313204	SUPLEMENTO A .004	SHIM	SPESSORE .004	CALE .004
	REC313205	313205	SUPLEMENTO A .005	SHIM	SPESSORE .005	CALE .005
	REC313206	313206	SUPLEMENTO A .006	SHIM	SPESSORE .006	CALE .006
36	REC981196	981196	RETÉN	OIL SEAL	PARAOLIO	JOINT D'HUILE
37	REC908069	908069	ENGRANAJE	BALL GEAR	INGRANAGGIO	ENGRENAGE
38	REC908064	908064	TUERCA	NUT	DADO	ÉCROU
39	REC908062	908062	TAPA	COVER	COPERCHIO	COUVERCLE

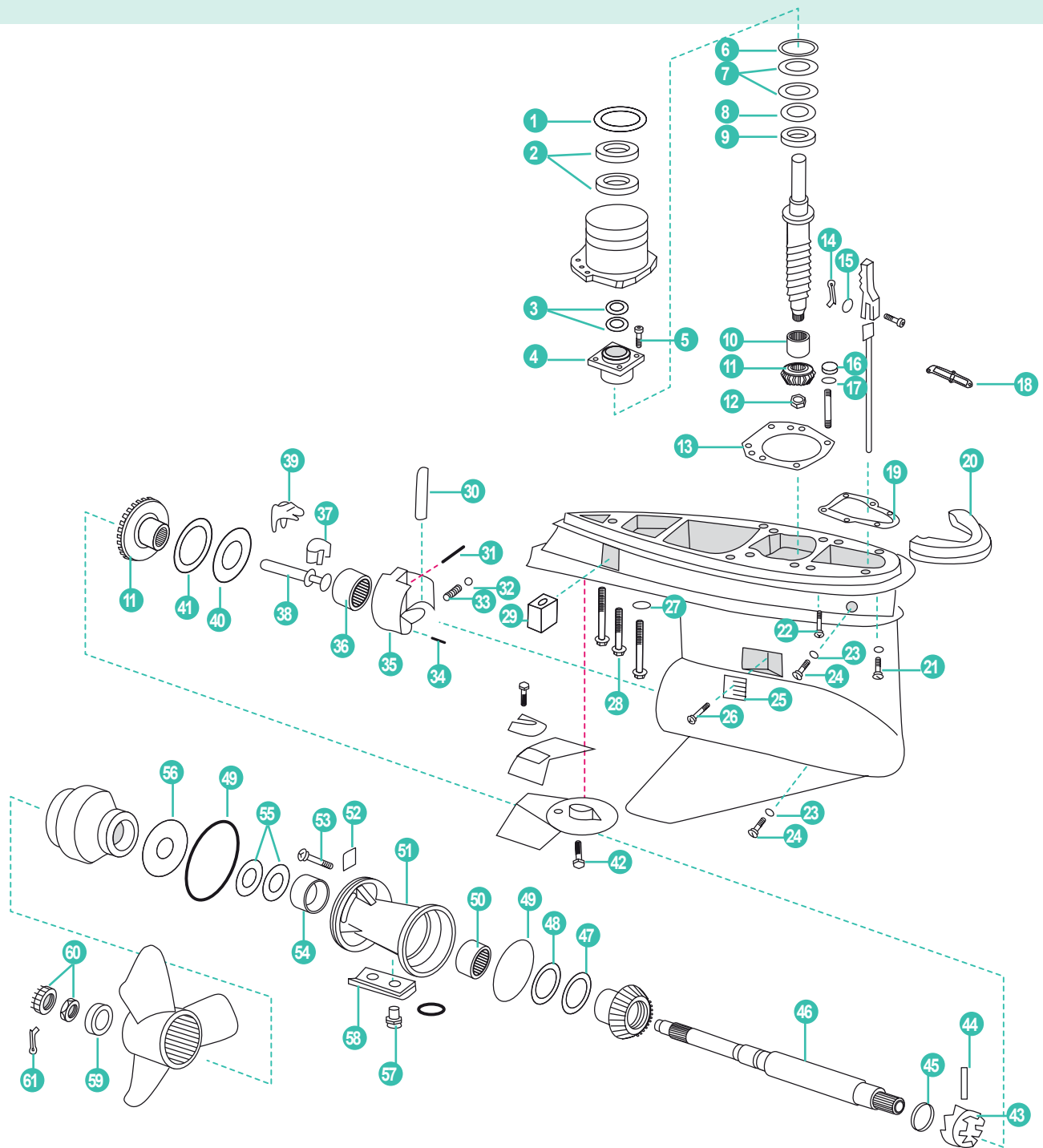

REF	OEM				
1	PAGB/T848-6	305981	ARANDELA	O-RING	RONDELLA RONDELLE
2	REC310649	310649	RETÉN	OIL SEAL	PARAOLI JOINT D'HUILE
3	REC321467	321467	RETÉN	OIL SEAL	PARAOLIO JOINT D'HUILE
4	REC982422	982422	TAPA RETENES	BEARING & HG SEAL	COPERCHIO PARAOLIO COUVERCLE JOINTS D'HUILE
5	REC317624	317624	TORNILLO	SCREW	VITE VIS
6	REC314728	314728	ANILLO GOMA	O-RING	ANELLO JOINT TORIQUE
	REC314745	314745	SUPLEMENTO.005	SHIM	SPESSORE .005 CALE .005
7	REC323361	323361	SUPLEMENTO.004	SHIM	SPESSORE .004 CALE .004
	REC323362	323362	SUPLEMENTO.003	SHIM	SPESSORE .003 CALE .003
8	REC327656	327656	TOPE ARANDELA	THRUST WASHER	FERMO RONDELLA RONDELLE
9	REC387656	387656	TOPE COJINETE	THRUST BEARING	FERMO CUSCINETTO FREIN DE ROULEMENT
	REC387817	387817	COJINETE	PINION BEARING	CUSCINETTO ROULEMENT
10	REC384195	384195	COJINETE GM 4CIL	PINION BEARING	CUSCINETTO GM 4 CIL ROULEMENT GM 4CYL
11	REC320635	5004941	KIT COMPLETO PIÑONES 5,0,5,8-V8	P/FORWARD GEAR SET 5,0, 5,8-V8	KIT PIGNONI COMPLETO 5,0, 5,8 - V8 KIT PIGNONS AVANT



	REF	OEM				
12	REC11-35921	314730	TUERCA	NUT	DADO	ÉCROU
13	REC910236	910236	JUNTA	GASKET	GUARNIZIONE	JOINT
	REC338484	910338	JUNTA GM 4 CIL.	GASKET	GUARNIZIONE GM 4 CYL	JOINT GM 4 CYL
14	REC306376	306376	PASADOR	COTTER PIN	CHIAVISTELLO	GOUPILLE
15	REC328702	306358	ARANDELA	WASHER	RONDELLA	RONDELLE
16	REC11-8267089	121731	TUERCA	NUT	DADO	ÉCROU
17	REC313353	313353	RETÉN	OIL SEAL	PARAOLI	JOINT D'HUILE
18	REC909604	909604	JUNTA	GASKET	GUARNIZIONE	JOINT
19	REC324670	352165	JUNTA	GASKET	GUARNIZIONE	JOINT
20	CM983494	983494	ANODO	ANODE	ANODO	ANODE
21	REC912127	912127	TORNILLO	SCREW	VITE	VIS
22	REC331999	331999	TORNILLO 3/8X1 3/4-16	SCREW 3/8 X 1 3/4-16	VITE 3/8 X 1 3/4-16	VIS 3/8 X 1 3/4 - 16
23	REC3855081	311598	JUNTA	GASKET	GUARNIZIONE	JOINT
24	REC22-67892A05	318544	TORNILLO CON RETÉN	DRAINIG SCREW	BULLONE CON ANELLO	BOUCHON DE VIDANGE MAGNETIQUE + JOINT
25	REC337778	337778	REJILLA	SCREEN	GRIGLIA	GRILLE
26	REC337061	337061	TORNILLO	SCREW	BULLONE	VIS
27	REC330265	330265	ARANDELA	LOCK WASHER	RONDELLA	RONDELLE
28	REC328096	328096	TORNILLO	SCREW	VITE	VIS
29	CM393023	436745	ANODO	ANODE	ANODO	ANODE
30	REC910310	910310	EJE RETENEDOR	PIN	ASSE RITENITORE	ARBRE DE RETENUE
31	REC328825	328825	PASADOR	PIN	CHIAVISTELLO	GOUPILLE
	REC313448	320145	PASADOR 4 CIL	PIN	CHIAVISTELLO 4 CIL	GOUPILLE 4 CYL
32	REC160084	160084	BOLA	DETENT BALL	BOLLA	BOULE
33	REC911962	911962	MUELLE	SPRING	MOLLA	RESSORT
34	REC331880	331880	PASADOR	PIN	CHIAVISTELLO	GOUPILLE
35	REC389455	389455	TAPA COJINETE	HSNG & BRING ASSY.	COPERCHIO CUSCINETTO	COUVERCLE ROULEMENT
36	REC389039	389039	COJINETE	BEARING	CUSCINETTO	ROULEMENT
	REC382407	382407	COJINETE 4 CIL	BEARING	CUSCINETTO	ROULEMENT 4 CYL
37	REC334163	982422	REGULADOR EJE	CRADLE	REGOLATORE ASSE	REGULATEUR D'ARBRE
38	REC322941	322941	EJE	SHAFT	ASSE	ARBRE
39	REC322938	322938	UÑA DESPLAZABLE	LEVER	CHIAVETTA	CROCHET
40	REC327669	327669	TOPE ARANDELA	THRUST WASHER	FERMO RONDELLA	RONDELLE FREIN
	REC324766	324766	TOPE ARANDELA 4 CIL	THRUST WASHER	FERMO RONDELLA 4 CIL	RONDELLE FREIN 4 CYL
41	REC389042	389042	TOPE COJINETE	THRUST BEARING	FERMO CUSCINETTO	FREIN ROULEMENT
	REC385043	385043	TOPE COJINETE 4 CIL	THRUST BEARING	FERMO CUSCINETTO 4 CIL	FREIN ROULEMENT 4 CYL
42	REC313715	313715	TORNILLO	SCREW	VITE	VIS
43	REC337774	337774	DESPLAZABLE	CLUTCH DOG	SCORREVOLE	CRABOT
	REC323664	323664	DESPLAZABLE	CLUTCH DOG	SCORREVOLE	CRABOT
44	REC313448	313448	PASADOR DESPLAZABLE	CROSS PIN	CHIAVISTELLO SCORREVOLE	GOUPILLE DU CRABOT
45	REC324369	324369	MUELLE	SPRING	MOLLA	RESSORT
46	REC395209	395209	EJE HÉLICE 800 MOD.	PROP SHAFT	ASSE ELICA 800	ARBRE D'HÉLICE 800
	REC436888	436888	EJE HÉLICE 1976-86	PROP SHAFT	ASSE ELICA 1976-86	ARBRE D'HÉLICE 1976-86
47	REC382408	382408	TOPE COJINETE	THRUST BEARING	FERMO CUSCINETTO	FREIN DE ROULEMENT
48	REC314731	314731	TOPE ARANDELA	THRUST WASHER	FERMO RONDELLA	RONDELLE FREIN
49	REC305123	305123	ARO	O-RING	ANELLO	JOINT TORIQUE
	REC313446	313446	ARO 4 CIL	O-RING	ANELLO 4 CYL	JOINT TORIQUE4 CYL
50	REC382407	382407	COJINETE	BEARING	CUSCINETTO	ROULEMENT
51	REC5000074	5000074	COJINETE DIÁBOLO	BEARING CARRIER	CUSCINETTO DIAVOLO	DIABOLO
52	REC333957	333957	PESTAÑA SUJECCIÓN	TAB	TAB	BAGUE DE RETENUE
53	REC350271	350271	TORNILLO	SCREW	VITE	VIS
54	REC387247	387247	COJINETE	BEARING	CUSCINETTO	ROULEMENT
	REC379504	379504	COJINETE 4 CIL	BEARING	CUSCINETTO 4 CIL	ROULEMENT 4 CYL
55	REC26-76868	320862	RETÉN	OIL SEAL	PARAOLIO	JOINT D'HUILE
	REC330137	330137	RETÉN 4 CIL	OIL SEAL	PARAOLIO 4 CIL	JOINT D'HUILE 4 CYL
56	REC126870	126870	TOPE ARANDELA (800)	THRUST WASHER	FERMO CUSCINETTO 800	RONDELLE FREIN 800
	REC127084	127084	TOPE ARANDELA 4 CIL	THRUST WASHER	FERMO CUSCINETTO 4 CIL	RONDELLE FREIN 4 CYL
57	REC908158	908158	TORNILLO	SCREW	VITE	VIS
58	CM431708	431708	ANODO	ANODE	ANODO	ANODE
59	REC320570	320570	TOPE HÉLICE (800)	SPACER	FERMO ELICA 800	RONDELLE BUTEE D'HELICE 800
	REC315810	315810	TOPE HÉLICE (400)	SPACER	FERMO ELICA 400	RONDELLE BUTEE D'HELICE400
60	REC314503	5008966	TUERCA 4 CIL	NUT	DADO 4 CIL	ÉCROU 4CYL
	REC398042	398042	TUERCA (800)	NUT	DADO 800	ÉCROU 800
	REC314502	314502	PASADOR 4 CIL	PIN	CHIAVISTELLO 4 CIL	GOUPILLE 4 CYL
61	REC3852056	306394	PASADOR (800)	PIN	CHIAVISTELLO 800	GOUPILLE 800

**TRANSOM  
COBRA (1986-93)**

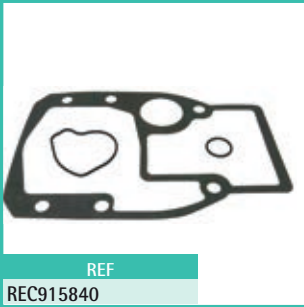

REF  
REC915840

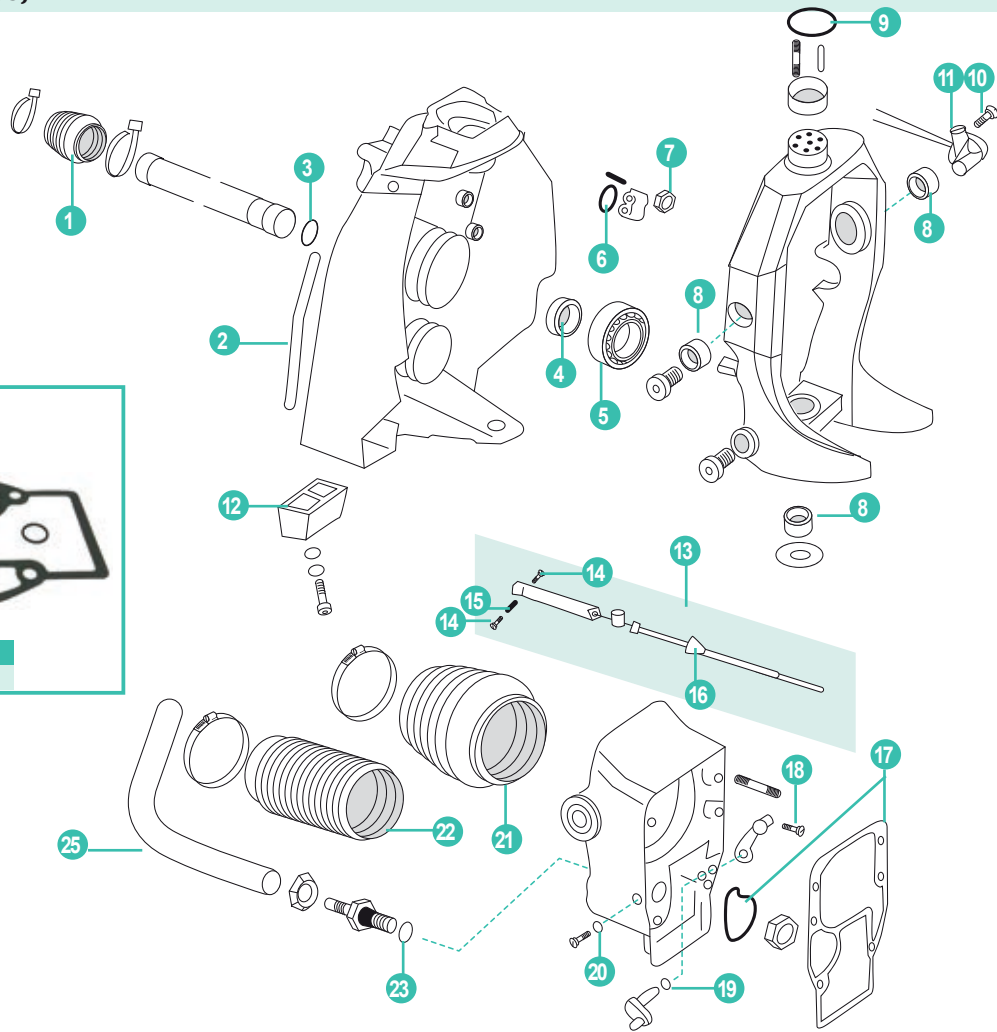

	REF	OEM				
1	CEF500506	911826	FUELLE CABLE CAMBIO	SHIFT CABLE BELLOW	CUFFIA CAVO CAMBIO	SOUFFLET CABLE CHANGEMENT
2	REC3852550	3852550	JUNTA TRANSOM	GASKET	GUARNIZIONE	JOINT
3	REC309731	911871	ARO	O-RING	ANELLO	JOINT TORIQUE
4	REC3852548	3852548	RETÉN TRASERO	REAR SEAL	PARAOLIO POSTERIORE	JOINT D'HUILE ARRIERE
5	REC30-879194A01	3853807	COJINETE TRANSOM	GIMBAL BEARING	CUSCINETTO TRANSOM	ROULEMENT TRANSOM
6	REC331188	322501	ARO	O-RING	ANELLO	JOINT TORIQUE
7	REC11-8267089	121731	TUERCA	LOCK NUT	DADO	ÉCROU
8	REC3808228	3852544	CASQUILLO	PIVOT PIN BEARING	BOCCOLA	BAGUE
9	REC25-33145	302337	ARO	O-RING	ANELLO	JOINT TORIQUE
10	REC308825	308825	TORNILLO	SCREW	VITE	VIS
11	RM3850470	3850470	SENSOR TRIM	TRIM SONDE	SENSORE TRIM	CAPTEUR TRIM
12	TEN00919	3853930	ANODO	ANODE	ANODO	ANODE
13	REC987661	987661	CABLE CAMBIO COBRA	SHIFT CABLE ASSEMBLY	CAVO CAMBIO COBRA	CÂBLE CHANGEMENT COBRA
	REC987678	987678	CABLE CAMBIO KING COBRA	SHIFT CABLE ASSEMBLY (KING COBRA)	CAVO CAMBIO KING COBRA	CÂBLE CHANGEMENT KING COBRA
14	REC10-20518	912304	TORNILLO	SET SCREW	VITE	VIS
15	REC43436	915918	ANCLAJE	ANCHOR	FERMO	ANCRAGE
16	REC304174	304174	ARO TORICO	O-RING	ANELLO	JOINT TORIQUE
17	REC915840	915840	KIT DE JUNTAS	GASKET SET	KIT GUARNIZIONE	KIT DE JOINTS
18	REC908158	908158	TORNILLO	SCREW	VITE	VIS
19	REC25-48171	202893	ARO TORICO	O-RING	ANELLO	JOINT TORIQUE
20	REC332583	911311	ARO	O-RING	ANELLO	JOINT TORIQUE
21	REC3841481	3854127	FUELLE TRANSOM	U-JOINT BELLOW	CUFFIA TRANSOM	SOUFFLET DE CARDAN
	CEF500514K	3854127	FUELLE TRANSOM	U-JOINT BELLOW	CUFFIA TRANSOM	SOUFFLET DE CARDAN
22	REC914036	914036	FUELLE ESCAPE	EXHAUST BELLOW	CUFFIA SCARICO	SOUFFLET D'ÉCHAPPEMENT
	CEF500527K	914036	FUELLE ESCAPE	EXHAUST BELLOW	CUFFIA SCARICO	SOUFFLET D'ÉCHAPPEMENT
23	REC3852535	911718	ARO	O-RING	ANELLO	JOINT TORIQUE
24	REC3852352	911830	TUBO SUBIDA AGUA	TRIM HOSE UP	TUBO ACQUA	DURITE D'EAU

TRANSON ANTIGUO

INTERMEDIATE HOUSING-  
STRINGER MOUNT

TRANSON VECCHIO

TRANSON ANCIEN

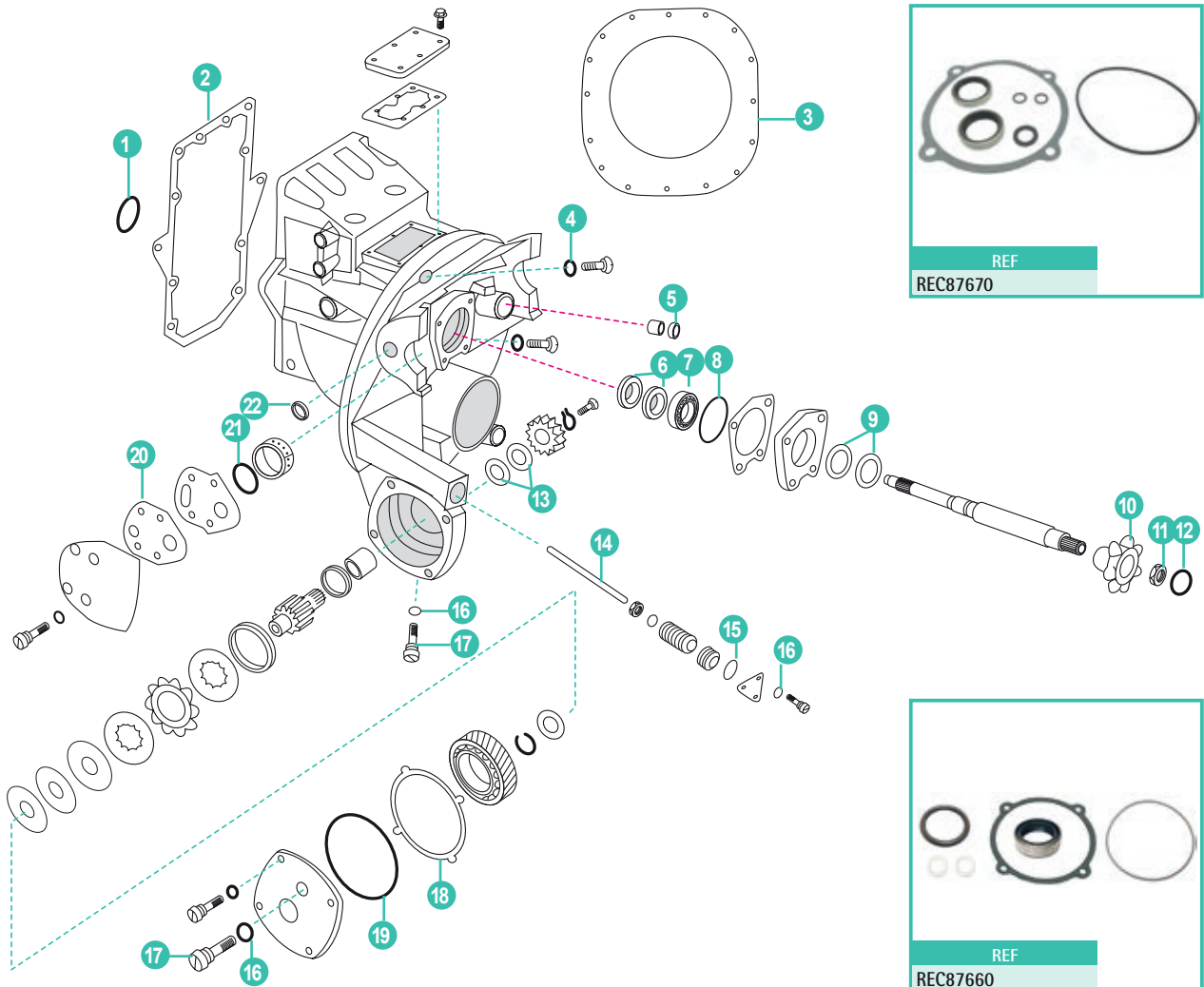

	REF	OEM				
1	REC25-33145	302337	ARO GOMA	O-RING	ANELLO	JOINT TORIQUE
2	REC909515	909515	JUNTA	GASKET	GUARNIZIONE	JOINT
3	REC313080	313080	GOMA TRANSON 120HP (1967-77)	PLATE SEAL 120 HP (1967-77)	GOMMA TRANSON 120 HP (1967-77)	JOINT DE TRANSON120HP (1967-77)
	REC909527	909527	GOMA TRANSON (1978-86)	PLATE SEAL (1978-86)	GOMMA TRANSON (1978-86)	JOINT DE TRANSON(1978-86)
4	REC315189	315189	JUNTA	GASKET	GUARNIZIONE	JOINT
5	REC908855	908855	RETÉN	OIL SEAL	PARAOLIO	JOINT D'HUILE
6	REC26-419533	764337	RETÉN	OIL SEAL	PARAOLIO	JOINT D'HUILE
7	REC31-86748A1	3854250	COJINETE	BEARING	CUSCINETTO	ROULEMENT
8	REC908383	908383	ARO	O-RING	ANELLO	JOINT TORIQUE
9	REC981195	981195	RETÉN	OIL SEAL	PARAOLIO	JOINT D'HUILE
10	REC908063	908063	ENGRANAJE	BALL GEAR	INGRANAGGIO	ENGRENAGE
11	REC908064	908064	TUERCA	NUT	DADO	ÉCROU
12	REC908062	908062	TAPA	COVER	COPERCHIO	COUVERCLE
13	REC321467	321467	RETÉN	OIL SEAL	PARAOLIO	JOINT D'HUILE
14	REC980183	980183	EJE ELEVADOR	TILT SHAFT	ALBERINO	ARBRE DE TILT
15	REC125017	302540	ARO	O-RING	ANELLO	JOINT TORIQUE
16	REC3855081	311598	JUNTA	GASKET	GUARNIZIONE	JOINT
17	REC10-79953Q04	307551	TORNILLO	SCREW	VITE	VIS
18	REC308799	308799	JUNTA	GASKET	GUARNIZIONE	JOINT
19	REC908194	908194	ARO GOMA	O-RING	ANELLO	JOINT TORIQUE
20	REC323338	316499	JUNTA CAMBIO ELECTRÓNICO	ELEC. SHIFT GASKET	GUARNIZIONE CAMBIO ELETTRONICO	JOINT CHANGEMENT ELECTRONIQUE
21	REC25-457101	308626	ARO GOMA	O-RING	ANELLO	JOINT TORIQUE
22	REC313244	313244	JUNTA	GASKET	GUARNIZIONE	JOINT

KITS REPARACIÓN

REPAIR KITS

KIT RIPARAZIONE

KITS DE RÉPARATION

COLAS

DRIVES

PIEDI

EMBASES

REF	OEM
REC915840	915840



REF	OEM
REC981801	981801

100 - 245 (1968-72)



400-800

REF	OEM
REC981797	981797

100 - 245 (1968-77)  
Cambio eléctrico | electric shift | cambio elettrico | changement électrique



REF	OEM
REC982946	982946

V6-V8 (1978-86)  
Cambio mecánico | mechanic shift | cambio meccanico | changement mécanique



REF	OEM
REC982947	982947

4 Cil. (1978-86)  
Cambio mecánico | mechanic shift | cambio meccanico | changement mécanique

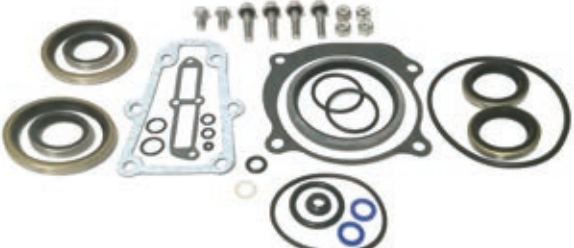

GOMAS TRANSOM

PLATE SEAL

GOMMA TRANSOM

JOINT DE TRANSOM

REF	OEM
REC313080	982946
REC909527	909527

(1967-77) 120 HP+  
(1978-86)



TRANSOM

KIT	REF	OEM	ARO	O-RING	ANELLO	BAGUE
REC87660	REC125017	302540	JUNTA	GASKET	GAURNIZIONE	JOINT
	REC12-191833	311598	ARANDELA	WASHER	RONDELLA	RONDELLE
	REC908194	908194	ARO	O-RING	ANELLO	BAGUE
	REC911019	911019	RETÉN	OIL SEAL	PARAOLIO	OINT SPI



KIT	REF	OEM	ARO	O-RING	ANELLO	BAGUE
REC87670	REC125017	302540	JUNTA	GASKET	GAURNIZIONE	JOINT
	REC308799	308799	ARANDELA	WASHER	RONDELLA	RONDELLE
	REC3855081	311598	ARO	O-RING	ANELLO	BAGUE
	REC908194	908194	RETÉN	OIL SEAL	PARAOLIO	OINT SPI

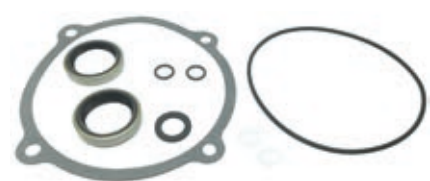



EJES BOMBA AGUA	WATER PUMP SHAFT	ASSE POMPA ACQUA	ARBRE POMPE D'EAU
-----------------	------------------	------------------	-------------------

REF	OEM
REC909753	909753
REC908087	908087



KIT BOMBA AGUA	WATER PUMP KIT	KIT POMPA ACQUA	KIT POMPE D'EAU
----------------	----------------	-----------------	-----------------

KIT	OEM	REF	OEM						
REC879031	983218	100 - 260 (1962-85)		REC310584	310584	ARO	O-RING	ANELLO	BAGUE
		COBRA	REC25-30613	310585	ARO	O-RING	ANELLO	JOINT	
			REC313176	313178	TAPA BOMBA	PUMP PLATE	COPERCHIO POMPA	RONDELLE	
			REC314491	314491	ARO	O-RING	ANELLO	BAGUE	
			REC777130	379475	TURBINA	IMPELLER	GIRANTE	TURBINE	
			REC907774	907774	RETÉN	OIL SEAL	PARAOLIO	JOINT SPI	
			REC910238	910238	ARO	O-RING	ANELLO	BAGUE	
			REC983298	983298	CARCASA	PUMP HOUSING	CARCASSA POMPA	CARCASSE	



JUNTAS	GASKETS	GUARNIZIONE	JOINTS
--------	---------	-------------	--------

VARILLA ACEITE	DIPSTICK	ASTICELLA DELL'OLIO	TIGE D'HUILE
----------------	----------	---------------------	--------------

REF	OEM
REC315189	315189



CIERRE COBRA	OUTDRIVE SEAL COBRA	CHIUSURA COBRA	FERMETURE COBRA
--------------	---------------------	----------------	-----------------

REF	OEM
REC3852560	3852560



SALIDA AGUA	WATER OUTLET	PASSAGGIO DELL ACQUA	SORTIE D'EAU
-------------	--------------	----------------------	--------------

REF	OEM
REC27-8146801	311069
	3789161GM



CAMBIO MECÁNICO	SWIVEL BRG. MECH SHIFT	CAMBIO MECCANICO	CHANGEMENT MECANIQUE
-----------------	------------------------	------------------	----------------------

REF	OEM
REC338484	910338
	324701
	338484



CAMBIO ELECTRÓNICO	SWIVEL BRG. ELECT. SHIFT	CAMBIO ELETTRONICO	CHANGEMENT ELECTRONIQUE
--------------------	--------------------------	--------------------	-------------------------

REF	OEM
REC313386	313368



## RETENES

## SEALS

## PARAOILIO

## JOINTS SPI

## GUÍA AROS TÓRICOS

## O'RING GUIDE

## GUIDA TENUTE

## GUIDE JOINTS SPI

REF.	OEM	Ø INT	Ø EXT	GRUESO THICK SPESSORE ESPESEUR
REC25-48171	202893	3/8	1/2	1/16
REC301877	301877	3 <sup>1/128</sup>	73/128	2 <sup>1/128</sup>
REC301967	301967	1 <sup>3/16</sup>	1	3/32
REC25-33145	302337	2	2 <sup>1/4</sup>	1/8
REC302537	302537	1 <sup>3/8</sup>	1 <sup>9/16</sup>	3/32
REC125017	302540	1	1 <sup>1/4</sup>	1/8
REC302588	302588	1 <sup>3/4</sup>	2	1/8
REC3852045	303067	3/8	9/16	3/32
REC25-62702	303191	5/16	7/16	1/16
REC303347	303347	7/16	5/8	3/32
REC25-35027	303360	1 <sup>1/16</sup>	1 <sup>5/16</sup>	1/8
REC304174	304174	1/2	5/8	1/16
REC305123	305123	3 <sup>3/4</sup>	4	1/8
REC305242	305242	5/16	9/16	1/8
REC3852928	305270	1 <sup>5/8</sup>	1 <sup>7/8</sup>	1/8
REC332583	305739	1/4	3/8	1/16
REC25-80863	307082	2 <sup>5/8</sup>	2 <sup>7/8</sup>	1/8
REC307450	307450	7/16	9/16	1/16
REC25-38933	307853	7/32	1 <sup>1/32</sup>	1/16
REC25-35029	308621	3 <sup>1/8</sup>	3 <sup>3/8</sup>	1/8
REC25-29845	308624	1 <sup>5/16</sup>	1 <sup>1/8</sup>	3/32
REC25-457101	308626	1 <sup>7/16</sup>	1 <sup>5/8</sup>	3/32
REC308627	308627	2 <sup>1/4</sup>	2 <sup>1/2</sup>	1/8
REC308876	308876	2 <sup>1/4</sup>	2 <sup>7/16</sup>	3/32
REC309731	309731	1 <sup>3/16</sup>	1 <sup>3/8</sup>	3/32
REC310414	310141	3 <sup>5/8</sup>	3 <sup>7/8</sup>	1/8
REC25-30224	310327	1 <sup>7/8</sup>	2 <sup>1/8</sup>	1/8
REC310414	310414	3 <sup>5/8</sup>	3 <sup>7/8</sup>	1/8
REC310584	310584	3/4	1	1/8
REC25-30613	310585	3/4	1 <sup>5/16</sup>	3/32
REC25-30613	310967	3/4	1 <sup>5/16</sup>	3/32
REC25-62705	311338	3/4	7/8	1/16
REC313175	313175	4 <sup>3/4</sup>	5	1/8
REC313340	31340	1 <sup>11/16</sup>	1 <sup>7/8</sup>	3/32
REC967344	313446	3 <sup>3/8</sup>	3 <sup>5/8</sup>	1/8
REC313754	313754	1 <sup>7/8</sup>	2 <sup>1/16</sup>	3/32
REC314491	314491	1	1 <sup>1/8</sup>	1/16
REC314728	314728	2 <sup>1/8</sup>	2 <sup>5/16</sup>	3/32
REC332583	317178	1/4	3/8	1/16
REC318372	318372	8 mm	16 mm	4 mm

REF.	OEM	Ø INT	Ø EXT	GRUESO THICK SPESSORE ESPESEUR
REC318717	318717	1 <sup>1/2</sup>	1 <sup>7/8</sup>	3/16
REC319085	319085	1 <sup>1/8</sup>	1 <sup>1/2</sup>	3/16
REC925093	320303	2 <sup>3/4</sup>	3	1/8
REC25-38933	321117	3/16	5/16	1/16
REC331188	322501	1 <sup>5/16</sup>	1 <sup>1/2</sup>	3/32
REC25-38933	322598	7/32	1 <sup>1/32</sup>	1/16
REC326649	326649	5/8	1 <sup>3/16</sup>	3/32
REC326741	326741	4 <sup>1/2</sup>	4 <sup>3/4</sup>	1/8
REC326849	326849	4 <sup>1/4</sup>	4 <sup>1/2</sup>	1/8
REC301877	326956	3 <sup>1/128</sup>	7 <sup>3/128</sup>	2 <sup>1/128</sup>
REC301877	326959	3 <sup>1/128</sup>	7 <sup>3/128</sup>	2 <sup>1/128</sup>
REC326649	329380	5/8	1 <sup>3/16</sup>	3/32
REC3852045	329381	3/8	9/16	3/32
REC332583	332583	1/4	3/8	1/16
REC332583	332584	1/4	3/8	1/16
REC333572	333572	1/4	7/16	3/32
REC338518	338518	2 <sup>9/16</sup>	2 <sup>3/4</sup>	3/32
REC338522	338522	1 <sup>5/8</sup>	1 <sup>13/16</sup>	3/32
REC339543	339543	1/2	1 <sup>1/16</sup>	3/32
REC25-25439	3852565	7/8	11 <sup>1/16</sup>	3/32
REC553126	553126	3 <sup>1/4</sup>	3 <sup>1/2</sup>	1/8
REC908194	908194	4	4 <sup>3/16</sup>	3/32
REC908383	908383	2 <sup>1/2</sup>	2 <sup>11/16</sup>	3/32
REC326649	909047	5/8	1 <sup>3/16</sup>	3/32
REC909048	909048	1/2	1 <sup>1/16</sup>	3/32
REC909139	909139	1	1 <sup>1/4</sup>	1/8
REC909140	909140	1 <sup>1/16</sup>	1 <sup>13/16</sup>	1/16
REC909316	909316	1 <sup>1/2</sup>	1 <sup>11/16</sup>	3/32
REC3852045	909747	5/16	1/2	3/32
REC910238	910238	5 <sup>1/4</sup>	5 <sup>1/2</sup>	1/8
REC25-30224	910582	1 <sup>7/8</sup>	2 <sup>1/8</sup>	1/8
REC332583	911311	1/4	3/8	1/16
REC25-70937	911686	3 <sup>1/2</sup>	3 <sup>3/4</sup>	1/8
REC911700	911700	4 <sup>1/8</sup>	4 <sup>3/8</sup>	1/8
REC3852535	911718	1 <sup>1/16</sup>	1 <sup>1/4</sup>	3/32
REC309731	911871	1 <sup>3/16</sup>	1 <sup>3/8</sup>	3/32

## GUÍA RETENES ACEITE

## OIL SEAL GUIDE



## GUIDA PARAOILIO

## GUIDE JOINTS SPI

REF.	OEM	EJE SHAFT SIZE ASSE ARBRE	CALIBRE BORE SIZE CALIBRE ASDFASD
REC302564	302564	0.7813	1.3750
REC303345	303345	0.5625	1.0000
REC767970	305987	1.0000	1.3750
REC309989	309989	1.3750	2.0000
REC310599	310599	1.0000	1.5000
REC310649	310649	2.5000	3.0000
REC313282	313282	0.5540	1.0625
REC313284	313284	0.6250	1.1250
REC313353	313353	1.9375	2.4375
REC26-419533	313392	1.1875	1.8750
REC314167	314167	0.4219	0.9375
REC341281	314218	1.2500	1.6875
REC341281	314281	1.2500	1.6875
REC318972	318972	0.50000	0.8750
REC29-47270	318972	0.5000	0.8750
REC26-76868	320862	1.1875	1.6875
REC26-69188	321453	0.8750	1.2500
REC321459	321459	0.6250	1.1250
REC321466	321466	0.7500	1.1250
REC321467	321467	1.0000	1.3750
REC321480	321480	0.5000	1.2500
REC321481	321481	0.6875	1.2500
REC321786	321786	0.6250	1.1250
REC321787	321787	0.6250	1.1250
REC321788	321788	0.5000	1.0000
REC321831	321831	0.7500	1.2500

REF.	OEM	EJE SHAFT SIZE ASSE ARBRE	CALIBRE BORE SIZE CALIBRE ASDFASD
REC321895	321895	1.6250	1.9219
REC321928	321928	0.6250	1.3750
REC324639	324639	0.4375	0.9375
REC327031	327031	0.4375	0.8750
REC26-76868	3286	1.1875	1.6875
REC329922	329922	0.8750	1.3750
REC329923	329923	0.8750	1.3750
REC330137	330137	1.2500	1.6250
REC330327	330327	0.6250	1.1250
REC331103	331103	1.1250	1.6250
REC342786	332205	0.7500	1.1250
REC332261	332261	0.6250	1.3750
REC334950	334950	1.2500	1.6875
REC339620	339620	1.6250	2.1250
REC341280	341280	0.8750	1.3750
REC353076	353076	1.6250	2.0625
REC3852272	3852272	45 mm	75 mm
REC3853655	3853655	0.5000	0.9062
REC853868	3853858	25 mm	35 mm
REC908855	908855	0.6250	1.0000
REC911019	911019	1.0000	2.5000
REC911685	911685	2.0000	2.5000
REC981195	981195	1.5000	2.1250
REC981196	981196	1.7500	2.5000
REC981268	981268	1.6250	2.5000

APLICACIÓN DE RETENES COBRA		COBRA SEALS APPLICATIONS		APPLICAZIONI PARAOLI COBRA		GUIDE JOINTS SPI COBRA	
		REF				CANTIDAD QUANTITY QUANTITÀ QUANTITÈ	
<b>TRANSOM</b>							
262 - 460	1988-90	REC3852548	EJE	DRIVESHAFT	ASSE	ARBRE	1
<b>PARTE SUPERIOR   UPPER GEARCASE   PARTE SUPERIORE   PARTIE SUPÉRIEURE</b>							
262 - 460	1988-90	REC911685	COJINETE	BEARING CARRIER	CUSCINETTO	ROULEMENT	1
350 - 460	1988-90	REC3853655	EJE BOMBA	PUMP SHAFT	ASSE POMPA	ARBRE POMPE	1
2.3 L - 7.5 L	1986-88	REC3853655	EJE BOMBA	PUMP SHAFT	ASSE POMPA	ARBRE POMPE	1
2.3 L - 7.5 L 5.7 L (1990) 574 AMPWS, ARPWS	1986-90	REC911685	COJINETE	BEARING CARRIER	CUSCINETTO	ROULEMENT	1
<b>PARTE INFERIOR   LOWER GEARCASE   PARTE INFERIORE   PARTIE INFÉRIEURE</b>							
262 - 460	1988-89	REC26-76868	EJE HÉLICE	PROP SHAFT	ASSE ELICA	ARBRE HÉLICE	2
2.3 L	1990	REC330137	EJE HÉLICE	PROP SHAFT	ASSE ELICA	ARBRE HÉLICE	2
2.3 L - 3.0 L	1986-89	REC330137	EJE HÉLICE	PROP SHAFT	ASSE ELICA	ARBRE HÉLICE	2
3.0 L	1990	REC26-76868	EJE HÉLICE	PROP SHAFT	ASSE ELICA	ARBRE HÉLICE	2
4.3 L - 7.5 L	1986-90	REC26-76868	EJE HÉLICE	PROP SHAFT	ASSE ELICA	ARBRE HÉLICE	2

GUIA CORREAS		V-BELTS GUIDE		GUIDA CINGHIE		GUIDE COURROIES	
		BOMBA AGUA WATER PUMP POMPA ACQUA POMPA D'EAU		DIRECCIÓN HIDRÁULICA POWER STEERING IDROGUIDA DIRECTION HYDRAULIQUE		ALTERNADOR ALTERNATOR ALTERNATORE ALTERNATEUR	
		REF		OEM			
120	165	190					
140	170	235					
145	175	240					
			✓			✓	REC3852106 311606
4 151			✓			✓	REC829207 310953
140							
155	225	245					
185	230	250					
210	235	260					
215	240		✓			✓	REC3858462 311046
V-6, V-8							
165		190	1972-76	✓		✓	REC3852106 311606
165C, 165S				✓		✓	REC3858462
40-1/4"				✓		✓	REC3858462
165C, 165S				✓		✓	REC966382
43-3/4"				✓		✓	REC3852106 311606
170			1974	✓		✓	REC3852106 311606
175			1975-77	✓		✓	REC3852106 311606
				✓		✓	REC3858462 311046
185			1978-84	✓	✓	✓	REC829207 909971
				✓	✓	✓	REC829207 909971
190			1974-77	✓		✓	REC3852106 311606
190				✓			REC3858462
225				✓			REC3858462
44-1/4"				✓		✓	REC3858462 311046
200			1979-81	✓	✓	✓	REC829207 909971
				✓	✓	✓	REC829207 909971
210			1970-71	✓		✓	REC3858462 311046
215				✓		✓	REC966382
				✓			GDY17335
V-8 302 Ford			1971	✓		✓	REC3858462 311046
225			1972-84	✓		✓	REC3858462 311046
250			1973	✓		✓	REC3858462 311046
				✓		✓	REC3858462 311046
			1979-81	✓	✓	✓	REC829207 909971
230				✓	✓	✓	REC829207 909971
260				✓		✓	REC3858462 311046
			1975	Salada   Sea Salata   Salée		✓	REC3852464 3852464
235			1971	✓		✓	REC3858462 311046
			1975-77	✓		✓	REC3852106 311606
240			1975-84	✓		✓	REC3852106 311606
250			1979	✓		✓	REC3852106 311606
245 Jet Drive			1973-75	✓		✓	REC3852106 311606

			BOMBA AGUA WATER PUMP POMPA ACQUA POMPA D'EAU	DIRECCIÓN HIDRÁULICA POWER STEERING IDROGUIDA DIRECTION HYDRAULIQUE	ALTERNADOR ALTERNATOR ALTERNATORE ALTERNATEUR	REF	OEM
			✓		✓	REC57-48122Q	3852504
262 King Cobra 4.3L (V-6 262)	1989		✓		✓	REC3852106	311606
			✓	✓		REC3852464	3852464
		Salada   Sea Salata   Salée				GDY15386	910414
290 Jet Drive	1974-75		✓		✓	REC3858462	311046
			✓		✓	REC3858462	311046
305 V-8 305	1977-84	46" Salada   Sea Salata   Salée				REC3852464	3852464
		50" Salada   Sea Salata   Salée				REC57-96834Q	912714
325 390 V-8 427					✓	REC57-48122Q	
			✓		✓	REC3858462	311046
350	1977-84	46" Salada   Sea Salata   Salée				REC3852464	3852464
V-8 350		50" Salada   Sea Salata   Salée				REC57-96834Q	912714
350 King Cobra			✓		✓	REC3852464	3852464
5.7L (V-8 350) 370	1988		✓	✓	✓	REC57-48122Q	3852504
			✓	✓	✓	REC57-78200Q1	3852504
V-8 454		Salada   Sea Salata   Salée				GDY15386	910414
			✓			REC57-48122Q	3852504
454	1977-82	Salada   Sea Salata   Salée			✓	REC3852464	3852464
V-8 454			✓			REC57-96834Q	912714
454 King Cobra			✓	✓		REC57-78200Q1	3852504
				✓		GDY15386	910414
V-8 454		Salada   Sea Salata   Salée				REC57-48122Q	3852504
460 King Cobra 7.5L (V-8 460)	1988		✓	✓	✓	REC829207	909971
			✓	✓	✓	REC57-34359	912714
888 V-8 427			✓		✓	REC966382	
2.3L "4" 140			✓		✓	REC966382	912509
			✓	✓	✓	REC966382	912509
2.5L, 3.0L 181			✓		✓	REC57-36356	910343
2.5L (1982-87)				✓	✓	REC3852106	311606
3.0L 181 (1982-89)				✓	✓	REC829207	909971
			✓		✓	REC57-48122Q	3852504
3.8L (V-6 229)			✓		✓	REC3852106	311606
4.3L (V-6 262)			✓	✓	✓	REC3852464	3852464
3.8L (V-6 229) (1982-86)			✓	✓	✓	REC3852464	3852464
4.3L (V-6 262) (1982-89)		Salada   Sea Salata   Salée				GDY15386	910414
			✓		✓	REC3852464	3852464
5.0L (V-8 305)			✓	✓	✓	REC57-48122Q	3852504
5.7L (V-8 350)			✓	✓	✓	REC3852464	3852464
5.0L (V-8 305) (1982-87)			✓	✓	✓	REC3852464	3852464
5.7L (V-8 350) (1982-90)		Salada   Sea Salata   Salée				GDY15386	910414
			✓		✓	REC3852106	311606C
5.0L (V-8 302)			✓		✓	REC3852106	311606C
5.7L (V-8 351)			✓	✓	✓	REC3858462	3858462
5.0L (V-8 305) (1988)			✓	✓	✓	REC3858462	3858462
5.8L (V-8 351)			✓		✓	REC3858462	3858462
7.5L (V-8 460)	1987		✓	✓	✓	REC829207	909971
			✓	✓	✓	REC57-34359	912714



**COMPONENTES DE COLA**

**GEARHOUSING COMPONENTS**

**COMPONENTI PIEDE**

**COMPONENTS D'EMBASES**

**ACOPLAMIENTOS**

**COUPLERS**

**PARASTRAPPI**

**ACCOUPEMENTS**

REF	OEM	AGUJERO HOLE FUORI TROU	CUBO SALIDA HUB OUTER CUBO CUBE	
REC3853962	3853962	Ø 91 mm	Ø 43 mm	2.5L (1986) 3.0L (1986-90), 4.3L, 5.0L, 5.7L (1986) KX & KWB 7.4L (1990-98), 8.2L (1992-93, 1998)



REF	OEM	AGUJERO HOLE FUORI TROU	CUBO SALIDA HUB OUTER CUBO CUBE	
REC3858437	3853917	Ø 76 mm	Ø 43 mm	4.3L (1986-98), 5.0L (1986-88, 1998), 5.7 (1986-92, 1994, 1996-98)



**FUELLES CABLE CAMBIO**

**SHIFT CABLE BELLOWS**

**CUFFIE CAMBIO**

**SOUFFLET CÂBLE CHANGEMENT**

REF	OEM	
CEF500506	911826	Cobra 1986-93



**FUELLES ESCAPE**

**EXHAUST BELLOWS**

**CUFFIE SCARICO**

**SOUFFLET D'ÉCHAPPEMENT**

REF	OEM	
REC914036 CEF500527K	914036	Cobra 1986-93



REF	OEM	
REC3852742	3852742	2.3/4.3/5.0/5.7/5.8L (1989-91) 2.3 1987-88, 4.3 1987-89, 5.0-5.8 Ford 1989-90, 5.7 1986, 5.7 1987-91, 1990-91 (350/454/454HO/460 King, 5.7LE 1990-91.

Manguito inferior  
Lower hose  
Manicotto inferiore  
Soufflet inférieur



REF	OEM	
REC3863450	3852741	2.5 1986 3.0 1986-91 2.3 1989-90 4.3 1990-91 5.0-5.8 Ford 1991 5.7 1986.



REF	OEM	
REC3852696	3852696	4.3 1991, 5.0-5.8 Ford 1991, 7.5 (460) 1988-89, 5.7LE 1990-91



REF	OEM	
REC912374 CEF500521K	912374	7.5 (460) 1987, 5.0-5.8 Ford 1989-90, 5.7 1986, 5.7 1987-1988.

Manguito superior  
Upper hose  
Manicotto superiore  
Soufflet supérieur



**FUELLES TRANSON**

**TRANSON BELLOWS**

**CUFFIE TRANSON**

**SOUFFLET TRANSON**

REF	OEM	
REC3841481 CEF500514K	3854127	Cobra 1986-98



**KIT ENGRANAJES TRANSOM**

**BALL GEAR KIT TRANSOM**

**KIT INGRANAGGIO TRANSOM**

**KIT PIGNONES TRANSOM**

KIT	REF	OEM					
REC22050	REC25-35029	308621	ARO	O-RING	ANELLO	BAGUE	1
	REC908062	908062	TAPA	BALL GEAR COVER	COPERCHIO	COUVERCLE	2
	REC908063	908063	ENGRANAJE	BALL GEAR	INGRANAGGIO	PIGNON	1
	REC908064	908064	TUERCA	NUT	DADO	ÉCROU	2
	REC908069	321467	ENGRANAJE	BALL GEAR	INGRANAGGIO	PIGNON	1
	REC908383	908383	ARO	O-RING	ANELLO	BAGUE	1
	REC981195	981195	RETÉN	OIL SEAL	PARAOLIO	JOINT SPI	2
	REC981196	981196	RETÉN	OIL SEAL	PARAOLIO	JOINT SPI	2



**EJES TRANSMISIÓN**

**DRIVES SHAFTS**

**ASSE TRASMISSIONE**

**ARBRE TRANSMISSION**

REF	OEM
REC909121	909121



REF	OEM	
REC981220	981220	V8 - V6



REF	OEM	
REC382883	382883	4 CIL.



**KIT PIÑONES Y DESPLAZABLES 14:26**

**GEAR SETS & CLUTCH DOGS 14:26**

**KIT PIGNONI E SELETTORI 14:26**

**KIT PIGNONES ET SELECTEURS 14:26**

REF	OEM
REC5004218	986980



REF	OEM		
REC337774	912607	3.8L / 229CI V6	1981-85
		4.3L / 262CI V6	1985
		5.0L / 305CI V8	1981-85
		5.7L / 350CI V8	1981-85



**KIT PIÑONES Y DESPLAZABLES 13:26**

**GEAR SETS & CLUTCH DOGS 13:26**

**KIT PIGNONI E SELETTORI 13:26**

**KIT PIGNONES ET SELECTEURS 13:26**

REF	OEM
REC986979	986979



REF	OEM		
REC323664	910578 323664	4 Cyl.	
		3.0L (1986-89)	
		2.3L (1987-90)	



**CABLE CAMBIO**

**SHIFT CABLE**

**CAVO CAMBIO**

**CÂBLE CHANGEMENT**

REF	OEM
REC987661	987661



REF	OEM	
REC987678	985518	
	986423	
	987604	KING COBRA
	987678	



**CABLE CAMBIO ELÉCTRICO**



**ELECTRIC SHIFT CABLE**

**CAVO CAMBIO ELETTRICO**

**CÂBLE CHANGEMENT ÉLECTRIQUE**

REF	OEM
REC379628	379628



CRUCETAS CARDAN	U-JOINTS	CROCIERA	CARDAN								
<table border="1"> <thead> <tr> <th>REF</th> <th>OEM</th> </tr> </thead> <tbody> <tr> <td>REC75832T</td> <td>912214</td> </tr> </tbody> </table> 	REF	OEM	REC75832T	912214		<table border="1"> <thead> <tr> <th>REF</th> <th>OEM</th> </tr> </thead> <tbody> <tr> <td>REC915716</td> <td>915716</td> </tr> </tbody> </table> 	REF	OEM	REC915716	915716	
REF	OEM										
REC75832T	912214										
REF	OEM										
REC915716	915716										
<table border="1"> <thead> <tr> <th>REF</th> <th>OEM</th> </tr> </thead> <tbody> <tr> <td>REC3850812</td> <td>3850812</td> </tr> </tbody> </table> 	REF	OEM	REC3850812	3850812							
REF	OEM										
REC3850812	3850812										

EJE HÉLICE CAMBIO MECÁNICO	PROP SHAFT MECHANICAL SHIFT	ASSE ELICA CAMBIO MECCANICO	ARBRE HÉLICE CHANGEMENT MECANIQUE		
4 CYL V6-V8					
✓	REC330137 330137	RETEN ACEITE EJE HELICE	OIL SEAL - PROP SHAFT	PARAOLIO ASSE ELICA	JOINT SPI ARBRE HÉLICE
✓	REC26-76868 320862	RETEN ACEITE EJE HELICE	OIL SEAL - PROP SHAFT	PARAOLIO ASSE ELICA	JOINT SPI ARBRE HÉLICE
✓	REC379504 379504	COJINETE ACEITE EJE HELICE	BEARING - PROP SHAFT	CUSCINETTO ASSE ELICA	ROULEMENT HUILE ARBRE
✓	REC387247 387247	COJINETE ACEITE EJE HELICE	BEARING - PROP SHAFT	CUSCINETTO ASSE ELICA	ROULEMENT HUILE ARBRE
✓	REC382407 382407	COJINETE CONTRARROTACIÓN	REVERSE GEAR BEARING CARRIER	CUSCINETTO CONTROROTANTE	ROULEMENT A AIGUILLE
✓	REC314731 314731	TOPE ARANDELA CONTRARROTACIÓN	THRUST WASHER FOR REVERSE GEAR	FERMO CONTROROTANTE	RONDELLE DE CALAGE
✓	REC382408 382408	TOPE COJINETE CONTRARROTACIÓN	THRUST BEARING FOR REVERSE GEAR	FERMO CUSCINETTO CONTROROTANTE	FREIN DE ROULEMENT
✓	REC967344 313446	ARO TÓRICO	O-RING	ANELLO	JOINT TORIQUE
✓	REC305123 305123	ARO TÓRICO	O-RING	ANELLO	JOINT TORIQUE
✓	REC436888 436888	EJE HÉLICE	PROP SHAFT	ASSE ELICA	ARBRE D'HÉLICE
✓	REC395209 395209	EJE HÉLICE	PROP SHAFT	ASSE ELICA	ARBRE D'HÉLICE



HERRAMIENTAS COLAS	STERNDRIVES TOOLS	ATTREZZATURA PIEDI	OUTIL D'EMBASSES				
<table border="1"> <thead> <tr> <th>REF</th> <th>OEM</th> </tr> </thead> <tbody> <tr> <td>REC91-805475A1</td> <td>912273</td> </tr> </tbody> </table> 	REF	OEM	REC91-805475A1	912273	<b>ENGINE ALIGNMENT TOOL</b>	<b>ALLINEAMENTO MOTORE</b>	<b>OUTIL D'ALIGNEMENT</b>
REF	OEM						
REC91-805475A1	912273						

# SISTEMA DE PROPULSIÓN PROPULSION SYSTEM

# SISTEMA DI PROPULSIONE SYSTEME DE PROPULSION

HÉLICES ALUMINIO E  
INOXIDABLE  
DE 3 Y 4 PALAS

3 & 4 BLADE  
ALUMINIUM & SS  
PROPELLERS

ELICHE ALLUMINIO E  
INOX DA 3 E 4 PALE

HELICE ALUMINIUM ET  
INOX 3 ET 4 PALES

CÓDIGO DE REFERENCIAS

PART NO. CODING SYSTEM

SISTEMA DI CODICE

CODAGE DES REFERENCES

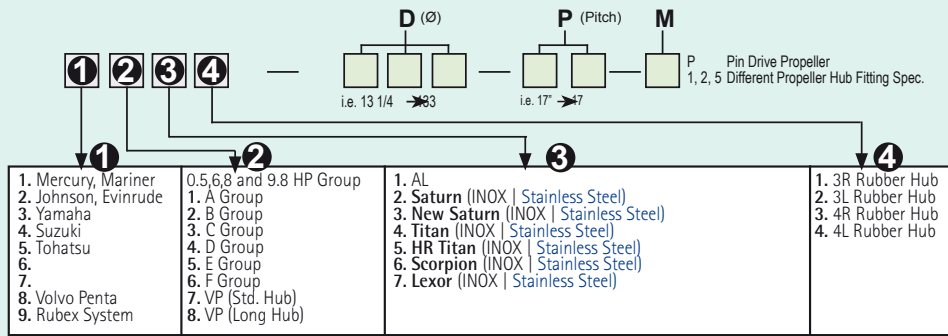

## AMITA 3



Hélice de aluminio con núcleo de goma de gran resistencia.

Aluminum propeller with heavy duty rubber hub.

Eliche di alluminio con mozzi in gomma ad alta resistenza.

Hélice en aluminium avec moyeu en caoutchouc



## AMITA 3 PLUS



Diseño de pala grande para un área más grande.

High camber blade and large blade area design.

Con un'area più ampia nelle pale.

Conception d'une grande pale pour une plus grande surface de poussée.



## HR TITAN 3 PROP



Hélice de acero inoxidable. Alto rendimiento para cascos de alta velocidad. La inclinación de la hoja proporciona un excelente elevación de proa y aceleración. El diseño de copa grande aumenta la mordida y reduce el deslizamiento.

Stainless steel propeller. Performance prop for high speed planning hulls. High rake blade design provides excellent bow lift and acceleration. Heavy cup design increases bite and reduces slip.

Eliche in acciaio inox. Alte prestazioni per scafi ad alta velocità. Il passo della pala fornisce un'eccellente spinta e accelerazione. Il disegno aumenta le prestazioni.

Hélice en acier inoxydable. Hélice de performance pour les coques planantes à grande vitesse. La conception de la pale à haut râteau offre une excellente portance et accélération. La conception des grandes pales augmente l'attaque et réduit le glissement.



## NEW SATURN



Hélices de acero inoxidable. Ofrece buena aceleración y rendimiento. Tamaño más pequeño que ofrece un diámetro extragrande.

Stainless steel propeller. Offers good acceleration & all-round performance. Smaller pitch sizes offered in extra large diameter with increased blade area.

Eliche di acciaio inox. Buona accelerazione. Piccole dimensioni che offre un più grande diametro.

Hélice inox, offrant de bonnes accélérations et performances. Taille de pas réduite pour les modèles de grands diamètres avec une surface de pale plus importante.



Palas  
Blades  
Pale  
Pales

Estrias  
Tooth Spline  
Scalanature  
Cannelure

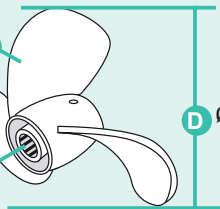



P Paso  
Pitch  
Passo  
Pas

R Rotación L (izquierda) R (derecha)  
Rotation L (left) R (Right)  
Rotazione L (SX) R (DX)  
Rotation L (gauche) R (droit)



GUÍA DE HÉLICES CON NÚCLEO INTEGRADO		PROPELLERS APPLICATION WITH RUBBER HUB					GUIDA ELICHE CON MOZZO		GUIDE DES HELICES AVEC MOYEUR	
OEM	A	B	D	P	R	AL		INOX STAINLESS STEEL		
						AMITA 3	AMITA 4	NEW SATURN	HR TITAN 3	
MOD 400 2,3 L - 3,0 L COBRA 2,3 L - 3,0 L	382761 765181 765182 765183 765184	3	14 13 <sup>3/4</sup> 13 <sup>1/2</sup> 13 <sup>1/4</sup> 13	11 13 15 17 19	R R R R R	AL	SOL2411-140-11 SOL2411-138-13 SOL2411-135-15 SOL2411-133-17 SOL2411-130-19	SOL2413-133-13 SOL2413-130-15 SOL2413-128-17 SOL2413-125-19	SOL2431-135-15 SOL2431-133-17 SOL2431-130-19	
MOD 800 COBRA KING COBRA 3,0 L et 8,2 L	765186 765186 765187 765187 765188 765188 391202 391202 391203 391203	15	15 <sup>1/4</sup> 15 <sup>1/4</sup> 15 15 14 <sup>4/5</sup> 14 <sup>4/5</sup> 14 <sup>1/2</sup> 14 <sup>1/2</sup> 14 <sup>1/4</sup> 14 <sup>1/4</sup>	15 15 17 17 19 19 21 21 23 23	R L R L R L R L R L	AL	SOL2511-150-15 SOL2512-150-15 SOL2511-148-17 SOL2512-148-17 SOL2511-145-19 SOL2512-145-19 SOL2511-143-21 SOL2512-143-21 SOL2511-142-23 SOL2512-142-23	SOL2513-148-15 SOL2514-148-15 SOL2513-145-17 SOL2514-145-17 SOL2513-143-19 SOL2514-143-19 SOL2513-140-23	SOL2531-145-15 SOL2532-145-15 SOL2531-143-17 SOL2532-143-17 SOL2531-140-19 SOL2532-140-19 SOL2531-140-21 SOL2532-140-21 SOL2531-140-23	
3.0 L 4.3 L 5.0 L 5.7 L 5.8 L 7.4 L	763315 3855479-6 763316 3855480-4 3850301-7 3855481-2 763318		15 15 14.8 14.8 14.5 14.5 14.3	15 15 17 17 19 19 21	R R L R L R L	AL	SOL8611-150-15 SOL8612-150-15 SOL8611-148-17 SOL8612-148-17 SOL8611-145-19 SOL8612-145-19 SOL8611-143-21 SOL8612-143-21 SOL8611-142-23	SOL8613-148-15 SOL8614-148-15 SOL8613-145-17 SOL8614-145-17 SOL8613-143-19 SOL8614-143-19 SOL8613-140-21 SOL8614-140-21		
SX	763319 763304 763305 763306 763307 763308 763309 763310 3850322-3 763312 763313	19	14.2 15 15 15 15 14 <sup>1/2</sup> 14 <sup>1/2</sup> 14 <sup>1/4</sup> 14 <sup>1/4</sup> 14 <sup>1/4</sup> 14 <sup>1/4</sup>	23 15 15 17 17 19 19 21 21 23 23	L R L R L R L R L R L	Inox SS	SOL8611-142-23			SOL8651-148-16 SOL8652-148-16 SOL8651-148-17 SOL8652-148-17 SOL8651-148-19 SOL8652-148-19 SOL8651-145-21 SOL8652-145-21 SOL8651-140-24 SOL8652-140-24

GUÍA DE NÚCLEOS		HUB KIT APPLICATION CHART		GUIDA MOZZI		GUIDE MOYEUR	
REF	A	REF		RUBEX			
400 Cobra, (1978-91)	13	SOLRBX-106	D				
800 Cobra, King Cobra (1978-90)	15	SOLRBX-101	E				
800 Cobra, King Cobra (1991-94),	15	SOLRBX-100	E				
Cobra SX, (1994+),	19	SOLRBX-105	E				

GUÍA DE HÉLICES AL (NÚCLEO NO INCLUIDO)					PROPELLERS AL CHART (HUB NOT INCLUDED)					GUIDA ELICHE AL (MOZZO NON INCLUSO)					GUIDE HÉLICES AL (MOYAU NO INCLUE)				
D (40-140HP)					E (135-300HP)					RUBEX									
B	D	P	R		B	D	P	R											
SOL9411-138-13	14	13	R		SOL9511-150-15	15	15	R											
SOL9411-135-15	3	14	15	R	SOL9511-148-17	3	15	17						R					
SOL9411-133-17	13	17	R		SOL9511-145-19	15	19	R											
SOL9411-132-19	13	19	R		SOL9511-143-21	14	21	R											
SOL9413-133-13	13,3	13	R		SOL9513-148-15	14,8	15	R											
SOL9413-130-15	4	13	15	R	SOL9513-145-17	4	14,5	17						R					
SOL9413-128-17	12,8	17	R		SOL9513-143-19	14,3	19	R											
SOL9413-125-19	13,2	19	R		SOL9513-140-21	14	21	R											

GUÍA DE HÉLICES INOX (NUCLEO NO INCLUIDO)

PROPELLERS SS CHART (HUB NOT INCLUDED)

GUIDA ELICHE INOX (MOZZO NON INCLUSO)

GUIDE HÉLICES INOX (MOYAU NO INCLUDE)

RUBEX

D (40-140HP) NS3	B	D	P	R
SOL9431-138-13	3	13 <sup>3/4</sup>	13	R
SOL9432-138-13		13 <sup>3/4</sup>	13	L
SOL9431-135-15		13 <sup>1/2</sup>	15	R
SOL9432-135-15		13 <sup>1/2</sup>	15	L
SOL9431-133-17		13 <sup>1/4</sup>	17	R
SOL9432-133-17		13 <sup>1/4</sup>	17	L
SOL9431-130-19		13	19	R
SOL9432-130-19		13	19	L
SOL9431-130-21		13	21	R



E (90-140HP) NS3	B	D	P	R
SOL9531-145-15	3	14 <sup>1/2</sup>	15	R
SOL9532-145-15		14 <sup>1/2</sup>	15	L
SOL9531-143-17		14 <sup>1/4</sup>	17	R
SOL9532-143-17		14 <sup>1/4</sup>	17	L
SOL9531-140-19		14	19	R
SOL9532-140-19		14	19	L
SOL9531-140-21		14	21	R
SOL9532-140-21		14	21	L
SOL9531-140-23		14	23	R
SOL9532-140-23	14	23	L	

E (135-350HP) L3	B	D	P	R
SOL9571-158-15	3	15 <sup>3/4</sup>	15	R
SOL9572-158-15		15 <sup>3/4</sup>	15	L
SOL9571-155-17		15 <sup>1/2</sup>	17	R
SOL9572-155-17		15 <sup>1/2</sup>	17	L
SOL9571-153-19		15 <sup>1/4</sup>	19	R
SOL9572-153-19		15 <sup>1/4</sup>	19	L
SOL9571-150-21		15	21	R
SOL9572-150-21		15	21	L
SOL9571-148-23		14 <sup>3/4</sup>	23	R
SOL9572-148-23	14 <sup>3/4</sup>	23	L	

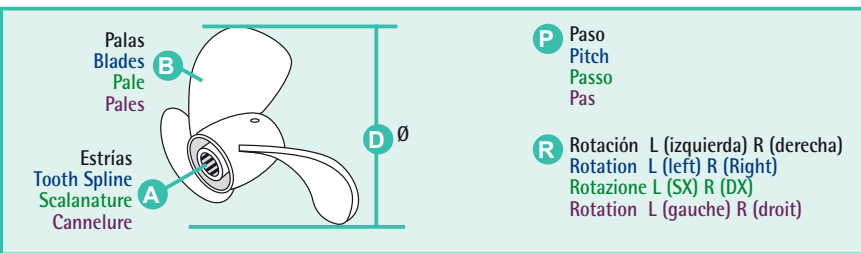

CIERRE DE HÉLICE

PROP HARDWARE

CHIUSURA ELICA

CONE D'HÉLICE

STRINGER 800 COBRA V (1978-87)  
COBRA & KING COBRA (1992-93)  
COBRA, KING & SX (1994+)

TOPE                      THRUST WASHER                      FERMO                      RONDELLE DE FREIN

REF	OEM
REC126870	126870



ESPACIADOR                      SPACER                      DISTANZIALE                      ENTRETOISE

REF	OEM	
REC320570	320570	Stringer 800 Cobra V (1978-87) Cobra & King Cobra (1992-93)
REC3852350	3852350	Cobra, King & SX (1994+)



PASADOR                      COTTER PIN                      CHIAVISTELLI                      GOUPILLE FENDUE

REF	OEM
REC3852056	306394



KITS

REF	OEM	
REC175266	175266	Stringer 800 Cobra V (1978-87) Cobra Et King Cobra (1992-93)

REF	OEM	
REC398042	5008966	

REF	OEM	
REC414153	434153	Stringer 800 Cobra V (1978-87) Cobra Et King Cobra (1992-93)

REF		
REC22188	REC3852350 + REC398042	Cobra, King Et SX (1994+)

STRINGER 400 DRIVES  
COBRA 4 CIL (1978-89)  
COBRA 2.3L (1990)

TOPE	THRUST WASHER	FERMO	RONDELLE DE FREIN

REF	OEM	
REC127084	127084	

ESPACIADOR	SPACER	DISTANZIALE	ENTRETOISE

REF	OEM	
REC315810	315810	

PASADOR	COTTER PIN	CHIAVISTELLI	GOUPILLE FENDUE

REF	OEM	
REC314502	314502	

TUERCA	NUT	DADO	ÉCROU

REF	OEM	
REC314503	314503	

KITS

REF	OEM	
REC175267	175267	

REF	OEM	
REC5005034	5005034	

# REF --> OEM

REF	OEM	
<b>A</b>		
Amita 3		696
Amita 3 PLUS		696
ARC6211	983318	634
ARCVR-404	383440	632

<b>B</b>		
BA1-312148	312148	670
BA1-380446	380446	661
BA1-908719	908716	670
BA1-910280	910280	661
BA1-910384	910384	662-663
BAOMC-1-980959	980959	669
BAOMC-1-3852347	3852347	667
BAOMC-1-907885	907885	661-662-663
BAOMC-1-981462	981462	661
BAOMC-1-982657	982657	662
BAOMC-1-984054	984054	663
BAOMC20-908014	908014	662
BAOMC20-910380	3850799	662-663
BAOMC20-980536	980536	661
BAOMC20-980617	980617	669
BAOMC20-981281	981281	669
BAOMC29-314810	314810	637
BAOMC29-314810	982201	637
BAOMC29-908216	908216	637
BAOMC29-910303	3854254	637
BAOMC47-311130	311130	670
BAOMC47-908935	908935	670

BRA125-1/2x1/2		622
BRA125-1/2x3/4		622
BRA125-1/2x3/8		622
BRA125-1/4x1/2		622
BRA125-1/4x3/8		622
BRA125-1x3/4		622
BRA125-3/16x1/4		622
BRA125-3/4x3/4		622
BRA125-3/8x1/2		622
BRA125-3/8x3/8		622
BRA125-5/16x3/8		622
BRA125-5/8x3/4		622
BRA125-5/8x3/8		622

<b>C</b>		
CEF500317	777128	675
CEF500506	911826	686-693
CEF500514K	3854127	686-693
CEF500521K	912374	693
CEF500527K	914036	686-693
CHARS12YC		639
CHARS9YC		639
CHARV15YC4		639
CM3855411	3855411	681
CM393023	436745	673-677-685
CM393023A	436745	673
CM431708	431708	673-679-685
CM431708A	431708	673
CM983494	983494	685
CM984513	3853818	677
<b>CMC</b>		
CMCC		673

<b>F</b>		
FEL17049		656
FEL17060	647-652-658-	659
FEL17068		655-660
FEL17124		651
FEL17145		654-657
FEL17146		652
FEL17160		647-658
FEL17161		647-658
FEL17165		652-659
FEL17166		652-659
FEL17168		655-660
FEL17169		655-660
FEL17205		654
FEL17244		653
FEL17245		653
FEL17260	647-652-658-	659
FEL17261	647-652-658-	659
FEL17268		655-660
FEL17342		657
FEL17360	647-652-658-	659
FEL17368		655-660
FEL17460	913393	669
FEL17460	3852455	667
FEL17468		655-660
FEL17725		649-650-651
FEL17746		647-659
FEL17936		655
FEL17945	835096	648-652-659-
FEL17946	3852687	660
FEL17947		648-652-660
FEL17947		656-660

REF	OEM	
FEL17983		649-651
FEL17985		657
FEL17994		656-660
FEL17995		647-658
FEL17996		652-659
FEL17997		647-658
FEL17998		652-659

<b>G</b>		
GDY15386	910414	692-692
GDY17335		691
GS30430		622
GS30431		622
GS30432		622
GS30433		622
GS31055		620-622
GS31056		620-622
GS31065		620
GS31066	22-89771Q2	620-622
GS31067		620
GS31157		620
GS35031		623
GS35032		623
GS35049		622
GS35050		622
GS35051		622
GS35052		622
GS35053		622
GS35054		622
GS35055		622

GS38320	3852604	661-662-663- 664-665-666- 667-668
GS38322	984387	665
GS38322	3853860	664-666-667- 668

<b>H</b>		
HGE3394	914766	669
HGE5470	985470	637
HGE6041	986041	669
HOT20244-MK		665-666
HOT20903	912442	665
HOT20921	909863	665-669
<b>HR TITAN 3 PROP</b>		

LENS3213	35-809097	620
LENS3227	35-886638	620
LENS3240		620

<b>M</b>		
MAR061	3857944	664-666-668
MAR499	3847499	664
MAR501	3857723	666
MP0180-001	10-812509184	632
MP426422	772846	625-628
MP426422	3854087	625

<b>N</b>		
New Saturn		696
NGKTR5		639
NGKUR4		639

<b>P</b>		
PAGB/T848-6	305981	677-684

<b>R</b>		
RAC1/2F-1/2M		622
RAC1/2X16		622
RAC1/2X18		622
RAC1/2X20		622
RAC120R-RAC-01		620
RAC3/8F-3/8M		622
RAC3/8X10		622
RAC3/8X12		622
RAC3/8X14		622
RAC320R-INOX-01		620
RAC320R-RAC-01		620
RAC320R-RAC-02	35-802893Q4	619-620
RACRK19492UL		623
RACRK20726		623
RACRK22628		623
RACS3213	35-809097	620
RACS3214	35-809099	620
RACS3220UL	35-809101	619-620
RACS3227	35-886638	620
RACS3228UL	173233	621
RACS3228UL	502901	621
RACS3228UL		620
RACS3240		620
REC0393988	391264	634
REC0393988	393259	634
REC0393988	393988	634
REC0393988	394176	634
REC0393988	983019	634
REC0393988	985237	634
REC0584107	387277	634
REC0584107	582048	634
REC0584107	582155	634

REF	OEM	
REC0586180	345419	633
REC0586180	383622	633
REC0586180	582708	633
REC0586180	586180	633
REC0979774	979774	633
REC0982706	982058	634
REC0982706	982706	634
REC0984536	984536	631
REC0984536	988013	631
REC0984628	984628	631
REC0985964	985964	633
REC0987883	3854194	631
REC10-20518	912304	686
REC10-37612	3853155	667
REC10-37612	3853326	668
REC10-79953Q04	307551	687
REC10-861788	10-861788	632
REC11-35921	314730	677-685
REC11-8267089	121731	677-685-686
REC11-862903	552938	661-662-663
REC12-191833	311598	688
REC123018	123018	675
REC125017	302540	683-687-688- 690
REC12532	382133	640
REC126870	126870	679-681-685- 698
REC127084	127084	685-699
REC13-35048	120177	661-662-663- 664-666-667- 668
REC13-35048	309336	665
REC13-39107	306325	665
REC13-39107	306470	661-662-663
REC13037	1114356	633
REC13430		636
REC1347-816373A4	981359	625-628
REC1347-816373A4	981428	625-628
REC1347-816373A4	981564	625-628
REC1347-816373A4	981705	625-628
REC1347-816373A4	981803	625-628
REC1347-816373A4	982215	625-628
REC1347-816373A4	982223	625-628
REC1347-816373A4	983855	625-628
REC1347-816373A4	985822	625-628
REC1347-818619R02	98053	628
REC1347-818619R02	381494	628
REC1347-818619R02	381498	624
REC1347-818619R02	382733	624-628
REC1347-818619R02	772831	624-628
REC1347-818619R02	979821	628
REC1347-818619R02	980530	624
REC1347-818619R02	982217	624
REC1347-818619R02	984180	624-628
REC1347-9661A3	382821	625-628
REC1347-9661A3	383766	625-628
REC1347-9661A3	384194	625-628
REC1396-4656	982537	626
REC1396-4656	982538	626
REC1396-4656		629
REC1396-5238	982539	626-629
REC1397-2060	381389	628-629
REC1397-2150	983870	621
REC1397-3327	383087	628
REC1397-3327	983871	628-629
REC1397-5831	508452	626
REC1397-6367A1	508459	626
REC1398-3089		629
REC1463-9382	3853548	638
REC15-401		639
REC15-405	503748	639
REC15-601	503750	639
REC15-602	503748	639
REC15-604		639
REC15-801	503752	639
REC15-801	503755	639
REC15-801		639
REC15-805	503753	639
REC15-806	503751	639
REC15-806	503752	639
REC15-806	503754	639
REC15-806	503755	639
REC15-811	503752	639
REC15-811	503755	639
REC16-56826	120177	662
REC16-56826	3852093	661-663
REC16-70236	314616	663
REC160084	160084	679-685
REC17000	908611	644-645
REC17000	3853336	644-645
REC17010	3854299	646
REC17020	3853380	648
REC17030	3853380	649-650
REC17040		653
REC17042		653
REC17048		656
REC17100		644-645



REF	OEM	REF	OEM	REF	OEM
REC17102		REC26901		REC315055	315055 625-661-662-663
REC17110		REC26905		REC315189	315189 683-687-689
REC17115		REC26905		REC315810	315810 685-699
REC17116		REC26904		REC317624	317624 677-684
REC17120		REC27-33395	856034	REC317624	317624 661-662-663
REC17125		REC27-33395	3852468	REC318372	318372 677-690
REC17140		REC27-46820	3852472	REC318717	318717 677-690
REC17146		REC27-52546	311068	REC318972	318972 690
REC17177A1	17177A1	REC27-53354	908079	REC319085	319085 690
REC17200		REC27-8079821	909758	REC32-33189	312781 671
FEL17205		REC27-8146801	311069	REC32-8M0071007	509282 671
REC17207		REC27-8146801	3789161GM	REC320140	320140 690
REC17210		REC27-815528	3853256	REC320570	320570 679-685-698
REC17211		REC27-96429		REC320635	5004941 684
REC17214		REC27-99757	3853412	REC321459	321459 690
REC17220		REC29-47270	318972	REC321466	321466 690
REC17224		REC30-879194A01	3853807	REC321467	321467 684-687-688-690
REC17230		REC300-00879	3852217	REC321480	321480 690
REC17232		REC301877	301877	REC321481	321481 690
REC17240		REC301877	326956	REC321786	321786 690
REC17241		REC301877	326959	REC321787	321787 690
REC17242		REC301967	301967	REC321788	321788 690
REC17243		REC302537	302537	REC321831	321831 690
REC17248		REC302564	302564	REC321895	321895 690
REC17310		REC302588	302588	REC321928	321928 690
REC17320		REC303345	303345	REC322938	322938 679-685
REC17340		REC303347	303347	REC322941	322941 679-685
REC17341		REC304027	304027	REC323338	316499 687
REC17342		REC304174	304174	REC323361	323361 677-684
REC175266	175266	REC305123	305123	REC323362	323362 677-684
REC175267	175267	REC305242	305242	REC323664	323664 685-694
REC17900	3852693	REC305282	305282	REC323664	910578 695
REC17903	3856443	REC306376	306376	REC324369	324369 679-685
REC17920	3854300	REC307450	307450	REC324639	324639 690
REC17921	3854942	REC308590	308590	REC324670	352165 685
REC17930	835096	REC308592	308592	REC324766	324766 679-685
REC17931	3852687	REC308627	308627	REC326649	326649 690
REC17935	856626	REC308768	308768	REC326649	329380 690
REC17937	3853513	REC308799	308799	REC326649	909047 690
REC17950	3853343	REC308825	308825	REC326741	326741 690
REC17970		REC308876	308876	REC326849	326849 690
REC17971	3852655	REC308928	308928	REC327031	327031 690
REC17980	855729	REC309731	309731	REC327656	327656 677-684
REC17981		REC309731	911871	REC327669	327669 679-685
REC17982	3856138	REC309989	309989	REC328096	328096 677-685
REC17986		REC31-35990A1	983891	REC328694	3852473 683
REC18-8553		REC31-66668A1	3854249	REC328702	306358 685
REC183247	3850853	REC31-86748A1	3854250	REC328825	328825 679-685
REC195141		REC310414	310141	REC329922	329922 690
REC21533394	987438	REC310414	310414	REC329923	329923 690
REC21533394	987440	REC310584	310584	REC330137	330137 679-685-690-691-695
REC21533394	987485	REC310599	310599	REC330265	330265 677-685
REC21533394	21533394	REC310649	310649	REC330327	330327 690
REC21533394		REC311121	311121	REC331103	331103 690
REC22-428611	315713	REC313080	313080	REC331188	322501 686-690
REC22-67892A05	318544	REC313080	982946	REC331880	331880 679-685
REC22-67892A05	318544	REC313163	313163	REC331999	331999 677-685
REC22-67892A05	3854539	REC313164	313164	REC332261	332261 690
REC22-67892A05	318544	REC313167	313167	REC332583	305739 690
REC22-73379		REC313175	313175	REC332583	317178 690
REC22050		REC313176	313176	REC332583	332583 690
REC22188		REC313194	313194	REC332583	332583 690
REC24950	35-60494A4	REC313194	313194	REC332583	332584 690
REC25-38933	321117	REC313195	313195	REC332583	911311 686-690
REC25-25439	3852565	REC313196	313196	REC333572	333572 690
REC25-29845	308624	REC313197	313197	REC333957	333957 679-685
REC25-30224	310327	REC313198	313198	REC334163	334163 679
REC25-30224	910582	REC313199	313199	REC334163	982422 685
REC25-30224	310327	REC313200	313200	REC334950	334950 679-690
REC25-30613	310585	REC313202	313202	REC336565	336565 679
REC25-30613	310967	REC313203	313203	REC33662	380537 641
REC25-33145	302337	REC313204	313204	REC33700	380543 642
REC25-35027	303360	REC313205	313205	REC337061	337061 677-685
REC25-35029	308621	REC313206	313206	REC33708	383587 641
REC25-38933	307853	REC313244	313244	REC33765T	980152 640
REC25-38933	322598	REC313282	313282	REC337774	337774 685
REC25-457101	308626	REC313284	313284	REC337774	912607 694
REC25-48171	202893	REC313340	313340	REC337778	337778 677-685
REC25-62702	303191	REC313340	313340	REC338484	324701 689
REC25-62705	311338	REC313353	313353	REC338484	338484 689
REC25-70937	911686	REC313386	313386	REC338484	910338 685-689
REC25-80863	307082	REC313446	313446	REC338518	338518 690
REC25000		REC313448	313448	REC338522	338522 690
REC25010		REC313448	320145	REC339543	339543 690
REC25020		REC313715	313715	REC339620	339620 690
REC25030		REC313754	313754	REC341280	341280 690
REC26-14756		REC314167	314167	REC341281	341281 690
REC26-419533	313392	REC314491	314491	REC341281	341281 690
REC26-419533	764337	REC314502	314502	REC34235T	380538 642
REC26-69188	321453	REC314503	314503	REC3423A1	332205 690
REC26-76868	3286	REC314503	5008966	REC342786	332205 690
REC26-76868	320862	REC314728	314728	REC35-03752	630
REC26-76868		REC314728	314728	REC35-06003	77864 621
REC26900		REC314731	314731	REC35-06004	173834 621
		REC314745	314745		

REF	OEM	REF	OEM	REF	OEM			
REC35-06004	502903	621	REC3854001	986642	640	REC46335	3853404	664-666-667
REC35-06007	502900	621	REC3854001	3854001	640	REC479956		664-666-668
REC35-49088A2	312456	621	REC3854002	3854002	638	REC50-806965A4	988217	632
REC35-49088A2	381690	621	REC3854003	986650	640	REC50-808011A05	981288	631
REC35-53336	908034	621	REC3854003	3854003	640	REC50-808011A05	984982	631
REC35-8M0061975	174144	619	REC3854020	986796	627	REC50-863007A1	3860566	632
REC35-8M0061975	502905	619	REC3854020	3854020	627	REC50-97499A2	981289	631
REC350271	350271	679-685	REC3854020	3854347	627	REC50-97499A2	982202	631
REC3517857	174796	621	REC3854020		629	REC50-99417A2	981078	631
REC3517857	502904	621	REC3854105	987313	627	REC50-99417A2	982121	631
REC353076	353076	690	REC3854105	3854105	627	REC50-99417A2	988217	631
REC3589522	3852561	675-680	REC3854105		629	REC50-99418A2	3860566	632
REC3589524	3852562	675-680	REC3854159	3854159	630	REC5000074	5000074	679-685
REC375761	375761	683	REC3854161	3854161	638	REC5004218	986980	677-679-694
REC379504	379504	679-685-695	REC3854190	987811	632	REC5004257	5004257	679
REC379585	379585	683	REC3854190	3854190	632	REC5004765	5004765	679
REC379628	379628	694	REC3854217	3854217	640	REC5005034	5005034	699
REC3808228	3852544	686	REC3854260	3854260	641	REC502900	502900	621
REC382138	986280	634	REC3854261	3854261	642	REC53773		664
REC382138	3853945	634	REC3854311		642	REC54-815504320	3853786	665
REC382165	382165	683	REC3854331	3854331	641	REC553126	553126	683-690
REC382212	382212	683	REC3854548	3854548	641	REC57-34359	912714	692
REC382407	382407	679-685-695	REC3854549		642	REC57-36356	910343	692
REC382408	382408	679-685-695	REC3854595	3854595	681	REC57-48122Q	3852504	692
REC382883	382883	683-694	REC3855081	311598	677	REC57-78200Q1	3852504	693
REC3841481	3854127	686-693	REC3855081	311598	683	REC57-96834Q	912714	692
REC384195	384195	677-684	REC3855081	311598	685	REC58217	384735	642
REC3850360	986292	637	REC3855081	311598	687	REC59830A7	912212	675-680
REC3850360	987716	637	REC3855081	311598	688	REC62092T	982063	624
REC3850360	3850360	637	REC3855081	333572	680	REC69729	988247	633
REC3850396	3850396	630	REC3855081	333572	681	REC70720		623
REC385043	385043	679-685	REC3855269	3855269	667	REC75832T	912214	675-695
REC3850495	3850495	662-663	REC3855271	3855271	667	REC763891	763891	666
REC3850594		674	REC3855275		681	REC764197	764197	675
REC3850812	3850812	675-680-695	REC3855276	981650	624	REC764799	764799	665-670
REC3850814	3850814	680	REC3857533	3857533	633	REC767970	305987	690
REC3850852	3850852	680	REC3857675	3857675	681	REC777128	777128	675
REC3850942	3850942	681	REC3858261	3854620	624	REC801766		642
REC3851411	3855411	672	REC3858261	3857986	624	REC802385	911702	675
REC3852045	303067	675-680-690	REC3858261	3858261	624	REC806490T	3853787	630
REC3852045	329381	690	REC3858437	3853917	693	REC823426A1	383918	626
REC3852045	909747	690	REC3858462	311046	691	REC823426A1	384743	626
REC3852056	306394	679-681-685-698	REC3858462	3858462	692	REC823426A1	979659	626
REC3852106	311606	691-692	REC3860769	985964	633	REC823426A1	983864	626
REC3852106	311606C	692	REC3860769	986008	633	REC823426A1		629
REC3852142	306422	661-662-663	REC3860842	3860842	680	REC823427A1	982384	626-627-629
REC3852165	910953	680	REC3862228		619	REC829207	310953	691
REC3852272	3852272	680-690	REC3862500	3862500	664-666	REC829207	909971	692-693
REC3852279	3852279	680	REC3863090	3863090	681	REC834975	980892	642
REC3852315	3852315	681	REC3863191	351325	664	REC835702	982336	641
REC3852317	3852317	680	REC3863191	913784	670	REC841243	982342	642
REC3852350	3852350	681-698	REC3863191	3863191	665-666-667-668	REC841994	983073	626
REC3852352	911830	686	REC3863450	3852741	663-664-666-667-668-693	REC841994	984487	626
REC3852454	908668	675-680	REC3863450	3852741	667-668-693	REC841994		629
REC3852455	3852455	647-652-658-659-667-669	REC3863193AL	3855411	672	REC853868	853858	680
REC3852464	3852464	691-692	REC387247	387247	679-685-695	REC853868	3853858	690
REC3852467	3852467	664-665-666	REC387656	387656	677-684	REC854040	3854402	681
REC3852476	909829	670	REC387817	387817	677-684	REC86234A4	982240	624
REC3852476	3852476	667-670	REC3885317		632	REC86234A4	985602	624
REC3852535	911718	686-690	REC389039	389039	679-685	REC86234A4	985603	624
REC3852538	3852538	664-666-668	REC389042	389042	679-685	REC87654		674
REC3852548	3852548	686-691	REC389455	389455	679-685	REC87660		687-688
REC3852550	3852550	686	REC391-5090	382135	642	REC87670		687-688
REC3852560	3852560	680-689	REC391-5090Q1		643	REC878982		670
REC3852568	3852568	675-680	REC392-6316		640	REC879031	983218	689
REC3852602	912627	667	REC392-6324Q1		643	REC89825302	982211	642
REC3852696	3852696	664-666-667-668-693	REC392-6325Q1		643	REC8M0068784	3857532	630
REC3852742	3852742	665-693	REC392-6330	985764	640	REC8M0125617	3855184	630
REC3852830	3852830	664-666-667-668	REC392-9086T	3853814	641	REC8M6001217	382136	641
REC3852865	3852865	681	REC392-9766	3853815	641	REC8M6001219	980893	642
REC3852866	3852866	681	REC393-9459Q1	380541	640	REC8M6001219	987136	642
REC3852928	305270	690	REC393831	912213	675-680	REC8M6001219	987894	642
REC3852959	3852959	681	REC395209	395209	679-685-695	REC8M6001249	987895	641
REC3853283	3853283	625	REC39631		680	REC907761	907761	661-662-663
REC3853341		648-649-650-651	REC397768	397768	672	REC907764	907764	661
REC3853434	3853434	667	REC397768AL	397768	672	REC907774	907774	683-689
REC3853655	3853655	675-690-691	REC398042	398042	685	REC907866	907866	683
REC3853796	982517	671	REC398042	5008966	699	REC908062	908062	683-687-694
REC3853796	3471293	671	REC398042	5008966	679-681	REC908063	908063	687-694
REC3853799	3853799	636	REC41400		630	REC908064	908064	694
REC3853801	3853801	642	REC414153	434153	699	REC908064	908064	683-687
REC3853839	982187	633	REC431708	431708	672	REC908069	321467	694
REC3853839	985063	633	REC431708AL	431708	672	REC908069	908069	683
REC3853854	3853854	635	REC43436	915918	686	REC908087	908087	683-689
REC3853855	3853855	635	REC434467	434467	679	REC908158	908158	679-685-686
REC3853856	3853856	635	REC436745	436745	672	REC908194	908194	690
REC3853857	3853857	635	REC436745AL	436745	672	REC908194	908194	687-688
REC3853934	3853934	681	REC436888	436888	679-685-695	REC908383	908383	687-690-694
REC3853945	986280	634	REC439967	439967	678	REC908765	908765	625
REC3853945	3853945	634	REC439967	984458	678	REC908855	908855	687-690
REC3853983	3853983	636	REC46-8M0113733	3858340	671	REC909048	909048	683-690
			REC46-8M0113734	985429	671	REC909121	909121	683-694
			REC46-8M0113734	3853850	671	REC909123	909123	683
			REC46-8M0113735	3855991	671	REC909139	909139	683-690
			REC46335	908700	665			



REF	OEM	REF	OEM	REF	OEM
REC909140	909140	REC984461	674	SOL8611-145-19	3850301-7 697
REC909232	909232	REC984462	677	SOL8611-148-17	763316 697
REC909316	909316	REC984491	621	SOL8611-150-15	763315 697
REC909368	909368	REC984744	675	SOL8612-143-21	697
REC909371	909371	REC985052	627-629	SOL8612-145-19	3855481-2 697
REC909515	909515	REC985218	641	SOL8612-148-17	3855480-4 697
REC909527	909527	REC985612	678	SOL8612-150-15	3855479-6 697
REC909604	909604	REC986158	672	SOL8613-140-21	763318 697
REC909610	909610	REC986158AL	672	SOL8613-143-19	3850301-7 697
REC909753	909753	REC986782	627-629	SOL8613-145-17	763316 697
REC91-805475A1	912273	REC986799	627	SOL8613-148-15	763315 697
REC910236	910236	REC986799	629	SOL8614-140-21	697
REC910238	910238	REC986838	986838	SOL8614-143-19	3855481-2 697
REC910240	910240	REC986979	986979	SOL8614-145-17	3855480-4 697
REC910310	910310	REC987067	3854061	SOL8614-148-15	3855479-6 697
REC910389	910389	REC987067AL	3854061	SOL8651-140-24	763312 697
REC911019	911019	REC987315	987315	SOL8651-145-21	763310 697
REC911668	911668	REC987661	987661	SOL8651-148-16	763304 697
REC911678	911678	REC987678	985518	SOL8651-148-17	763306 697
REC911679	911679	REC987678	986423	SOL8651-148-19	763308 697
REC911680	911680	REC987678	987604	SOL8652-140-24	763313 697
REC911681	911681	REC987678	987678	SOL8652-145-21	3850322-3 697
REC911685	911685	REC987739	982749	SOL8652-148-16	763305 697
REC911693	911693	REC987739	982755	SOL8652-148-17	763307 697
REC911697	911697	REC987739	982774	SOL8652-148-19	763309 697
REC911698	911698	REC987739	984036	SOL9411-132-19	697
REC911699	911699	REC987739	984276	SOL9411-133-17	697
REC911700	911700	REC987739	984281	SOL9411-135-15	697
REC911703	911703	REC987739	984281	SOL9411-138-13	697
REC911704	911704	REC987739	984730	SOL9413-125-19	697
REC911705	911705	REC987739	985902	SOL9413-128-17	697
REC911715	911715	REC987739	986342	SOL9413-130-15	697
REC911750	911750	REC987739	986837	SOL9413-133-13	697
REC911751	911751	REC987739	987738	SOL9431-130-19	698
REC911753	911753	REC987739	987739	SOL9431-130-21	698
REC911878	911878	REC987739	987740	SOL9431-133-17	698
REC911937	911937	REC987800	987800	SOL9431-133-15	698
REC911962	385367	REC9D-116	673	SOL9431-138-13	698
REC911962	911962	RECOBBRACKET	619	SOL9432-130-19	698
REC912127	912127	RECRA122002	631	SOL9432-133-17	698
REC912157	912157	RECRK21069	623	SOL9432-135-15	698
REC912238	912238	RM21610333	3854086	SOL9432-138-13	698
REC912374	912374	RM3850470	983939	SOL9511-143-21	697
REC912614	912614	RM3850470	984731	SOL9511-145-19	697
REC913393	913393	RM3850470	3850470	SOL9511-148-17	697
REC914036	914036	RM3852516	910953	SOL9511-150-15	697
REC914488	914488	RM3854874	3854874	SOL9513-140-21	697
REC915716	915716	RM3861459	3861459	SOL9513-143-19	697
REC915719	915719	RM3862228	502906	SOL9513-145-17	697
REC915720	915720	RM3862228	987754	SOL9513-148-15	697
REC915840	915840	<b>S</b>		SOL9531-140-19	698
REC915954	915954	SHEG9901	3858847	SOL9531-140-21	698
REC925093	320303	SHEG9903	3851982	SOL9531-140-23	698
REC925093	925093	SHEG9903	3855079	SOL9531-143-17	698
REC966382	912509	SHEG9903	3857794	SOL9531-145-15	698
REC967344	313446	SOL2411-130-19	765184	SOL9532-140-19	698
REC967344	3852308	SOL2411-133-17	765183	SOL9532-140-21	698
REC97258A1	171960	SOL2411-135-15	765182	SOL9532-140-23	698
REC976669	976669	SOL2411-138-13	765181	SOL9532-143-17	698
REC976669AL	976669	SOL2411-140-11	382761	SOL9532-145-15	698
REC980183	980183	SOL2413-125-19	765184	SOL9571-148-23	698
REC981195	981195	SOL2413-128-17	765183	SOL9571-150-21	698
REC981196	981196	SOL2413-130-15	765182	SOL9571-153-19	698
REC981220	981220	SOL2413-133-13	765181	SOL9571-155-17	698
REC981268	981268	SOL2431-130-19	765184	SOL9571-158-15	698
REC981797	981797	SOL2431-133-17	765183	SOL9572-148-23	698
REC981799	981799	SOL2431-135-15	765182	SOL9572-150-21	698
REC981801	981801	SOL2511-142-23	391203	SOL9572-153-19	698
REC981911	981911	SOL2511-143-21	391202	SOL9572-155-17	698
REC982209	982209	SOL2511-145-19	765188	SOL9572-158-15	698
REC982230	982230	SOL2511-148-17	765187	SOLRBX-100	697
REC982386	381400	SOL2511-150-15	765186	SOLRBX-101	697
REC982386	982386	SOL2512-142-23	391203	SOLRBX-105	697
REC982386	982386	SOL2512-143-21	391202	SOLRBX-106	697
REC982386	982386	SOL2512-145-19	765188		
REC982422	982422	SOL2512-148-17	765187		
REC982438	982438	SOL2512-150-15	765186	TRI305-0386	623
REC982438AL	982438	SOL2513-140-23	391203	TRI305-0566	623
REC982946	982946	SOL2513-143-19	765188		
REC982947	982947	SOL2513-145-17	765187		
REC982949	982949	SOL2513-148-15	765186		
REC982997	982997	SOL2514-143-19	765188		
REC983298	983298	SOL2514-145-17	765187		
REC983494	983494	SOL2514-148-15	765186		
REC983494AL	983494	SOL2531-140-19	765188		
REC983825	983825	SOL2531-140-21	391202		
REC983826	983826	SOL2531-140-23	391203		
REC983877	983877	SOL2531-143-17	765187		
REC983878	983878	SOL2531-145-15	765186		
REC983878	983878	SOL2532-140-19	765188		
REC983880	983880	SOL2532-140-21	391202		
REC983892	983892	SOL2532-143-17	765187		
REC983952	984547	SOL2532-145-15	765186		
REC983952AL	983952	SOL8611-142-23	763319		
REC983967	983967	SOL8611-143-21	763318		
REC984012	984012				
REC984264	984264				

# OEM --> REF

OEM	REF	OEM	REF	OEM	REF
3286	REC26-76868	690	311598	REC3855081	687
31340	REC313340	690	311598	REC3855081	688
98053	REC1347-818619R02	628	311606	REC3852106	691-692
120177	REC13-35048	661-662-663-664-666-667-668	312148	BA1-312148	670
120177	REC16-56826	662	312456	REC35-49088A2	621
121731	REC11-8267089	677-685-686	312781	REC32-33189	671
123018	REC123018	675	313080	REC313080	687
126870	REC126870	679-681-685-698	313163	REC313163	683
127084	REC127084	685-699	313164	REC313164	683
160084	REC160084	679-685	313167	REC313167	683
171960	REC97258A1	630	313175	REC313175	675-683-690
173233	RACS3228UL	621	313176	REC313176	683-689
173834	REC35-06004	621	313193	REC313194	683
174144	REC35-8M0061975	619	313194	REC313194	683
174796	REC3517857	621	313195	REC313195	683
175266	REC175266	699	313196	REC313196	683
175267	REC175267	699	313197	REC313197	683
202893	REC25-48171	686-690	313198	REC313198	683
301877	REC301877	690	313199	REC313199	683
301967	REC301967	690	313200	REC313200	683
302337	REC25-33145	686-687-690	313202	REC313202	683
302537	REC302537	690	313203	REC313203	683
302540	REC125017	683-687-688-690	313204	REC313204	683
302564	REC302564	690	313205	REC313205	683
302588	REC302588	690	313206	REC313206	683
303067	REC3852045	675-680-690	313244	REC313244	687
303191	REC25-62702	690	313282	REC313282	690
303345	REC303345	690	313284	REC313284	690
303347	REC303347	690	313340	REC313340	690
303360	REC25-35027	690	313353	REC313353	685-690
304027	REC304027	677	313368	REC313368	689
304174	REC304174	686-690	313392	REC26-419533	690
305123	REC305123	685-690-695	313446	REC313446	685
305242	REC305242	690	313446	REC967344	679-690-695
305270	REC3852928	690	313448	REC313448	679-685
305282	REC305282	683	313715	REC313715	679-685
305739	REC332583	690	313754	REC313754	690
305981	PAGB/T848-6	677-684	314167	REC314167	690
305987	REC767970	690	314218	REC341281	690
306325	REC13-39107	665	314281	REC341281	690
306358	REC328702	685	314491	REC314491	683-689-690
306376	REC306376	685	314502	REC314502	685-699
306394	REC3852056	679-681-685-698	314503	REC314503	699
306422	REC3852142	661-662-663	314616	REC16-70236	663
306470	REC13-39107	661-662-663	314728	REC314728	677-690
307082	REC25-80863	690	314728	REC314728	684
307450	REC307450	690	314730	REC11-35921	677-685
307551	REC10-79953Q04	687	314731	REC314731	679-685-695
307853	REC25-38933	690	314745	REC314745	677-684
308590	REC308590	683	314810	BAOMC29-314810	637
308592	REC308592	683	315055	REC315055	625-661-662-663
308621	REC25-35029	683-690-694	315189	REC315189	683-687-689
308624	REC25-29845	690	315713	REC22-428611	664-665-666-667-668
308626	REC25-457101	687-690	315810	REC315810	685-699
308627	REC308627	690	316499	REC323338	687
308768	REC308768	683	317178	REC332583	690
308799	REC308799	687-688	317624	REC317624	677-684
308825	REC308825	677-686	318372	REC318372	677-690
308876	REC308876	690	318544	REC22-67892A05	677
308924	REC308928	683	318544	REC22-67892A05	685
309336	REC13-35048	665	318544	REC22-67892A05	683
309731	REC309731	690	318717	REC318717	677-690
309989	REC309989	690	318972	REC29-47270	690
310141	REC310141	690	318972	REC318972	690
310327	REC25-30224	690	319085	REC319085	690
310327	REC25-30224	683	320140	REC320140	690
310414	REC310414	690	320145	REC313448	685
310584	REC310584	689-690	320303	REC925093	690
310585	REC25-30613	689-690	320570	REC320570	679-685-698
310599	REC310599	690	320862	REC26-76868	685-690-695
310649	REC310649	684-690	321117	REC25-38933	690
310953	REC829207	691	321453	REC26-69188	690
310967	REC25-30613	690	321459	REC321459	690
311046	REC3858462	692	321466	REC321466	690
311068	REC27-52546	661-662	321467	REC321467	684-687-688-690
311069	REC27-8146801	689	321467	REC908069	694
311121	REC311121	661-662-663	321480	REC321480	690
311130	BAOMC47-311130	670	321481	REC321481	690
311338	REC25-62705	690	321786	REC321786	690
311598	REC12-191833	688	321787	REC321787	690
311598	REC3855081	677	321788	REC321788	690
311598	REC3855081	683	321831	REC321831	690
311598	REC3855081	685	321895	REC321895	690
311598	REC3855081	685	321928	REC321928	690
322501	REC331188	686-690			
322598	REC25-38933	690			
322938	REC322938	679-685			
322941	REC322941	679-685			
323361	REC323361	677-684			
323362	REC323362	677-684			
323664	REC323664	685-694			
324369	REC324369	679-685			
324639	REC324639	690			
324701	REC338484	689			
324766	REC324766	679-685			
326649	REC326649	690			
326741	REC326741	690			
326849	REC326849	690			
326956	REC301877	690			
326959	REC301877	690			
327031	REC327031	690			
327656	REC327656	677-684			
327669	REC327669	679-685			
328096	REC328096	677-685			
328825	REC328825	679-685			
329380	REC326649	690			
329381	REC3852045	690			
329922	REC329922	690			
329923	REC329923	690			
330137	REC330137	679-685-690-691-695			
330265	REC330265	677-685			
330327	REC330327	690			
331103	REC331103	690			
331880	REC331880	679-685			
331999	REC331999	677-685			
332205	REC342786	690			
332261	REC332261	690			
332583	REC332583	690			
332584	REC332583	690			
333572	REC333572	690			
333572	REC3855081	680			
333572	REC3855081	681			
333957	REC333957	679-685			
334163	REC334163	679			
334950	REC334950	679-690			
336565	REC336565	679			
337061	REC337061	677-685			
337774	REC337774	685			
337778	REC337778	677-685			
338484	REC338484	689			
338518	REC338518	690			
338522	REC338522	690			
339543	REC339543	690			
339620	REC339620	690			
341280	REC341280	690			
345419	REC0586180	633			
350271	REC350271	679-685			
351325	REC3863191	664			
352165	REC324670	685			
353076	REC353076	690			
375761	REC375761	683			
379504	REC379504	679-685-695			
379585	REC379585	683			
379628	REC379628	694			
380446	BA1-380446	661			
380537	REC33662	641			
380538	REC34235T	642			
380541	REC393-9459Q1	640			
380543	REC33700	642			
381389	REC1397-2060	628-629			
381400	REC982386	626			
381494	REC1347-818619R02	628			
381498	REC1347-818619R02	624			
381690	REC35-49088A2	621			
382125	REC8M6001217	641			
382133	REC12532	640			
382135	REC391-5090	642			
382136	REC8M6001217	641			
382165	REC382165	683			
382212	REC382212	683			
382407	REC382407	679-685-695			
382408	REC382408	679-685-695			
382733	REC1347-818619R02	624-628			
382761	SOL2411-140-11	697			
382821	REC1347-9661A3	625-628			
382883	REC382883	683-694			
383087	REC1397-3327	628			
383440	ARCVR-404	632			
383587	REC33708	641			



OEM	REF		OEM	REF		OEM	REF	
383622	REC0586180	633	763319	SOL8611-142-23	697	909604	REC909604	685
383766	REC1347-9661A3	625-628	763891	REC763891	666	909610	REC909610	665
383918	REC823426A1	626	764197	REC764197	675	909747	REC3852045	690
384194	REC1347-9661A3	625-628	764337	REC26-419533	687	909753	REC909753	683-689
384195	REC384195	677-684	764799	REC764799	665-670	909758	REC27-8079821	625
384735	REC58217	642	765181	SOL2411-138-13	697	909829	REC3852476	670
384743	REC823426A1	626	765181	SOL2413-133-13	697	909863	HOT20921	665-669
385043	REC385043	679-685	765182	SOL2411-135-15	697	909971	REC829207	692
385367	REC911962	679	765182	SOL2413-130-15	697	910236	REC910236	685
387247	REC387247	679-685-695	765182	SOL2431-135-15	697	910238	REC910238	683-689-690
387277	REC0584107	634	765183	SOL2411-133-17	697	910240	REC910240	683
387656	REC387656	677-684	765183	SOL2413-128-17	697	910280	BA1-910280	661
387817	REC387817	677-684	765183	SOL2431-133-17	697	910310	REC910310	685
389039	REC389039	679-685	765184	SOL2411-130-19	697	910338	REC338484	685-689
389042	REC389042	679-685	765184	SOL2413-125-19	697	910343	REC57-36356	692
389455	REC389455	679-685	765184	SOL2431-130-19	697	910384	BA1-910384	662-663
391202	SOL2511-143-21	697	765186	SOL2511-150-15	697	910389	REC910389	662
391202	SOL2512-143-21	697	765186	SOL2512-150-15	697	910414	GDY15386	692
391202	SOL2531-140-21	697	765186	SOL2513-148-15	697	910578	REC323664	694
391202	SOL2532-140-21	697	765186	SOL2514-148-15	697	910582	REC25-30224	683-690
391203	SOL2511-142-23	697	765186	SOL2531-145-15	697	910953	REC3852165	680
391203	SOL2512-142-23	697	765186	SOL2532-145-15	697	910953	RM3852516	675
391203	SOL2513-140-23	697	765187	SOL2511-148-17	697	911019	REC911019	688-690
391203	SOL2531-140-23	697	765187	SOL2512-148-17	697	911311	REC332583	686-690
391264	REC0393988	634	765187	SOL2513-145-17	697	911668	REC911668	675
393259	REC0393988	634	765187	SOL2514-145-17	697	911678	REC911678	675
393988	REC0393988	634	765187	SOL2531-143-17	697	911679	REC911679	675
394176	REC0393988	634	765187	SOL2532-143-17	697	911680	REC911680	675
395209	REC395209	679-685-695	765188	SOL2511-145-19	697	911681	REC911681	675
397768	REC397768	672	765188	SOL2512-145-19	697	911685	REC911685	675-690
397768	REC397768AL	672	765188	SOL2513-143-19	697	911686	REC25-70937	675-690
398042	REC398042	685	765188	SOL2514-143-19	697	911693	REC911693	677
431708	CM431708	679-685	765188	SOL2531-140-19	697	911697	REC911697	675
431708	REC431708	672	765188	SOL2532-140-19	697	911698	REC911698	675
431708	REC431708AL	672	772831	REC1347-818619R02	624-628	911699	REC911699	675
434153	REC414153	699	772846	MP426422	625-628	911700	REC911700	675-690
434467	REC434467	679	777128	CEF500317	675	911702	REC802385	675
436745	CM393023	677-685	777128	REC777128	675	911703	REC911703	675
436745	REC436745	672	778864	REC35-06003	621	911704	REC911704	675
436745	REC436745AL	672	835096	FEL17945	648-652-659-660	911705	REC911705	677
436888	REC436888	679-685-695	835096	REC17930	649-650-651	911715	REC911715	677
439967	REC439967	678	853858	REC853858	680	911718	REC3852535	686-690
502900	REC35-06007	621	855729	REC17980	649-650-651	911750	REC911750	675
502900	REC502900	621	856034	REC27-33395	648	911751	REC911751	675
502901	RACS3228UL	621	856365	REC17320	648-650-651	911753	REC911753	675
502903	REC35-06004	621	856626	REC17935	655-657	911826	CEF500506	686-693
502904	REC3517857	621	857177	REC17310	646	911830	REC3852352	686
502905	REC35-8M0061975	619	907761	REC907761	661-662-663	911871	REC309731	686-690
502906	RM3862228	619	907764	REC907764	661	911878	REC911878	677
503748	REC15-405	639	907774	REC907774	683-689	911937	REC911937	675
503748	REC15-602	639	907866	REC907866	683	911962	REC911962	685
503750	REC15-601	639	907885	BAOMC1-907885	661-662-663	912127	REC912127	677-685
503751	REC15-806	639	908014	BAOMC20-908014	662	912157	REC912157	677
503752	REC15-801	639	908034	REC35-53336	621	912212	REC59830A7	675-680
503752	REC15-806	639	908062	REC908062	683-687-694	912213	REC393831	675-680
503752	REC15-811	639	908063	REC908063	687-694	912214	REC75832T	675-695
503753	REC15-805	639	908064	REC908064	694	912238	REC912238	675
503754	REC15-806	639	908064	REC908064	683-687	912273	REC91-805475A1	695
503755	REC15-801	639	908069	REC908069	683	912304	REC10-20518	686
503755	REC15-806	639	908079	REC27-53354	663-645	912374	CEF500521K	693
503755	REC15-811	639	908087	REC908087	683-689	912374	REC912374	665-693
508452	REC1397-5831	626	908158	REC908158	679-685-686	912392	TEN00712	679
508459	REC1397-6367A1	626	908194	REC908194	690	912442	HOT20903	665
509282	REC32-8M0071007	671	908194	REC908194	687-688	912509	REC966382	691-692
552938	REC11-862903	661-662-663	908216	BAOMC29-908216	637	912607	REC337774	694
552940	REC317624	661-662-663	908383	REC908383	687-690-694	912614	REC912614	675
553126	REC553126	683-690	908611	REC17000	644-645	912627	REC3852602	667
582048	REC0584107	634	908668	REC3852454	675-680	912714	REC57-34359	692
582155	REC0584107	634	908700	REC46335	665	912714	REC57-96834Q	692
582708	REC0586180	633	908716	BA1-908719	670	913393	FEL17460	669
586180	REC0586180	633	908765	REC908765	625	913393	REC913393	658-669
763304	SOL8651-148-16	697	908855	REC908855	687-690	913784	REC3863191	670
763305	SOL8652-148-16	697	908935	BAOMC47-908935	670	914036	CEF500527K	686-693
763306	SOL8651-148-17	697	909047	REC326649	690	914036	REC914036	686-693
763307	SOL8652-148-17	697	909048	REC909048	683-690	914488	REC914488	675
763308	SOL8651-148-19	697	909121	REC909121	683-694	914766	HGE3394	669
763309	SOL8652-148-19	697	909123	REC909123	683	915716	REC915716	695
763310	SOL8651-145-21	697	909139	REC909139	683-690	915719	REC915719	677
763312	SOL8651-140-24	697	909140	REC909140	683-690	915720	REC915720	677
763313	SOL8652-140-24	697	909232	REC909232	662-663-665	915840	REC915840	675-686-688
763315	SOL8611-150-15	697	909316	REC909316	675-690	915918	REC43436	686
763315	SOL8613-148-15	697	909368	REC909368	661	915954	REC915954	679
763316	SOL8611-148-17	697	909371	REC909371	661-662-663-665	925093	REC925093	680
763316	SOL8613-145-17	697	909515	REC909515	687	976669	REC976669	672
763318	SOL8611-143-21	697	909527	REC909527	687-688	976669	REC976669AL	672
763318	SOL8613-140-21	697				979659	REC823426A1	626

OEM	REF	OEM	REF	OEM	REF
979774	REC0979774	633	984276	REC987739	643
979821	REC1347-818619R02	628	984281	REC987739	643
980152	REC33765T	640	984387	GS38322	665
980183	REC980183	687	984458	REC439967	678
980530	REC1347-818619R02	624	984462	REC984462	677
980536	BAOMC20-980536	661	984487	REC841994	626
980617	BAOMC20-980617	669	984491	REC984491	621
980892	REC834975	642	984536	REC0984536	631
980893	REC8M6001219	642	984547	REC983952	672
980959	BAOMC-1-980959	669	984547	REC983952AL	672
981195	REC981195	687-690-694	984628	REC0984628	631
981196	REC981196	683-690-694	984730	REC987739	643
981220	REC981220	683-694	984731	RM3850470	635
981268	REC981268	683-690	984744	REC984744	675
981281	BAOMC20-981281	669	984982	REC50-808011A05	631
981288	REC50-808011A05	631	985052	REC985052	627-629
981289	REC50-97499A2	631	985063	REC3853839	633
981359	REC1347-816373A4	625-628	985218	REC985218	641
981428	REC1347-816373A4	625-628	985237	REC0393988	634
981462	BAOMC1-981462	661	985429	REC46-8M0113734	671
981564	REC1347-816373A4	625-628	985470	HGE5470	637
981650	REC3855276	624	985518	REC987678	694
981705	REC1347-816373A4	625-628	985602	REC86234A4	624
981797	REC981797	688	985603	REC86234A4	624
981801	REC981801	688	985612	REC985612	678
981803	REC1347-816373A4	625-628	985764	REC392-6330	640
981911	REC981911	621	985822	REC1347-816373A4	625-628
982058	REC0982706	634	985902	REC987739	643
982063	REC62092T	624	985964	REC0985964	633
982187	REC3853839	633	985964	REC3860769	633
982201	BAOMC29-314810	637	986008	REC3860769	633
982202	REC50-97499A2	631	986041	HGE6041	669
982209	REC982209	641	986280	REC382138	634
982211	REC89825302	642	986280	REC3853945	634
982215	REC1347-816373A4	625-628	986292	REC3850360	637
982217	REC1347-818619R02	624	986342	REC987739	643
982223	REC1347-816373A4	625-628	986423	REC987678	694
982230	REC982230	621	986642	REC3854001	640
982240	REC86234A4	624	986650	REC3854003	640
982336	REC835702	641	986782	REC986782	627-629
982342	REC841243	642	986784	REC986799	627
982384	REC823427A1	626-627-629	986796	REC3854020	627
982386	REC982386	626	986799	REC986799	627
982422	REC334163	685	986837	REC987739	643
982422	REC982422	684	986838	REC986838	677
982438	REC982438	672	986979	REC986979	677-679-694
982438	REC982438AL	672	986980	REC5004218	677-679-694
982517	REC3853796	671	987136	REC8M6001219	642
982537	REC1396-4656	626	987313	REC3854105	627
982538	REC1396-4656	626	987315	REC987315	627-629
982539	REC1396-5238	626-629	987438	REC21533394	627
982657	BAOMC1-982657	662	987440	REC21533394	627
982706	REC0982706	634	987485	REC21533394	627
982749	REC987739	643	987604	REC987678	694
982755	REC987739	643	987661	REC987661	686-694
982774	REC987739	643	987678	REC987678	686-694
982946	REC313080	688	987716	REC3850360	637
982946	REC982946	688	987738	REC987739	643
982947	REC982947	688	987739	REC987739	643
982997	REC982997	624	987740	REC987739	643
983019	REC0393988	634	987754	RM3862228	619
983073	REC841994	626	987800	REC987800	673
983218	REC879031	689	987811	REC3854190	632
983298	REC983298	683-689	987894	REC8M6001219	642
983318	ARC6211	634	987895	REC8M6001249	641
983494	CM983494	685	988013	REC0984536	631
983494	REC983494	672	988217	REC50-806965A4	632
983494	REC983494AL	672	988247	REC69729	633
983825	REC983825	675	1114356	REC13037	633
983826	REC983826	675	3471293	REC3853796	671
983855	REC1347-816373A4	625-628	3847499	MAR499	664
983864	REC823426A1	626	3850360	REC3850360	637
983870	REC1397-2150	621	3850396	REC3850396	630
983871	REC1397-3327	628-629	3850470	RM3850470	635-686
983877	REC983877	675	3850495	REC3850495	662-663
983878	REC983878	675	3850799	BAOMC20-910380	662-663
983880	REC983880	675	3850812	REC3850812	675-680-695
983891	REC31-35990A1	675	3850814	REC3850814	680
983892	REC983892	675	3850852	REC3850852	680
983939	RM3850470	635	3850853	REC183247	680
983967	REC983967	675	3850942	REC3850942	681
984012	REC984012	675	3851982	SHEG9903	637
984036	REC987739	643	3852093	REC16-56826	661-663
984054	BAOMC1-984054	663	3852217	REC300-00879	638
984180	REC1347-818619R02	624-628	3852272	REC3852272	680-690
984264	REC984264	675	3852279	REC3852279	680
3852308	REC967344	680			
3852315	REC3852315	681			
3852317	REC3852317	680			
3852347	BAOMC1-3852347	667			
3852350	REC3852350	681-698			
3852455	FEL17460	667			
3852455	REC3852455	647-652-658-659-667-669			
3852464	REC3852464	691-692			
3852467	REC3852467	664-665-666			
3852468	REC27-33395	665-666			
3852472	REC27-46820	654-657-668			
3852473	REC328694	683			
3852476	REC3852476	667-670			
3852504	REC57-48122Q	692			
3852504	REC57-78200Q1	693			
3852538	REC3852538	664-666-668			
3852544	REC3808228	686			
3852548	REC3852548	686-691			
3852550	REC3852550	686			
3852560	REC3852560	680-689			
3852561	REC3589522	675-680			
3852562	REC3589524	675-680			
3852565	REC25-25439	675-680-690			
3852568	REC3852568	675-680			
3852604	GS38320	661-662-663-664-665-666-667-668			
3852655	REC17971	646			
3852687	FEL17946	648-652-660			
3852687	REC17931	649-651			
3852693	REC17900	645			
3852696	REC3852696	664-666-667-668-693			
3852741	REC3863450	663-664-666-667-668-693			
3852742	REC3852742	665-693			
3852830	REC3852830	664-666-667-668			
3852865	REC3852865	681			
3852866	REC3852866	681			
3852959	REC3852959	681			
3853155	REC10-37612	667			
3853256	REC27-815528	645			
3853283	REC3853283	625			
3853326	REC10-37612	668			
3853336	REC17000	644-645			
3853343	REC17950	645			
3853380	REC17020	648			
3853404	REC17030	649-650			
3853412	REC46335	664-666-667			
3853434	REC27-99757	646-664			
3853434	REC3853434	667			
3853513	REC17937	655-657			
3853548	REC1463-9382	638			
3853655	REC3853655	675-690			
3853786	REC54-815504320	665			
3853787	REC806490T	630			
3853799	REC3853799	636			
3853801	REC3853801	642			
3853807	REC30-879194A01	686			
3853814	REC392-9086T	641			
3853815	REC392-9766	641			
3853818	CM984513	672-677			
3853818	CM984513A	672			
3853850	REC46-8M0113734	671			
3853854	REC3853854	635			
3853855	REC3853855	635			
3853856	REC3853856	635			
3853857	REC3853857	635			
3853858	REC853868	690			
3853860	GS38322	664-666-667-668			
3853917	REC3858437	693			
3853930	REC986158	672			
3853930	REC986158AL	672			
3853930	TEN00919	686			
3853934	REC3853934	681			
3853945	REC382138	634			
3853945	REC3853945	634			
3854001	REC3854001	640			
3854002	REC3854002	638			
3854003	REC3854003	640			
3854020	REC3854020	627			
3854061	REC987067	672			
3854061	REC987067AL	672			
3854086	RM21610333	625-628			
3854087	MP426422	625			
3854105	REC3854105	627			

OEM	REF	
3854127	CEF500514K	686-693
3854127	REC3841481	686-693
3854159	REC3854159	630
3854161	REC3854161	638
3854190	REC3854190	632
3854194	REC0987883	631
3854217	REC3854217	640
3854249	REC31-66668A1	681
3854250	REC31-86748A1	681-687
3854254	BAOMC29-910303	637
3854260	REC3854260	641
3854261	REC3854261	642
3854299	REC17010	646
3854300	REC17920	647
3854331	REC3854331	641
3854347	REC3854020	627
3854402	REC854040	681
3854539	REC22-67892A05	681
3854548	REC3854548	641
3854595	REC3854595	681
3854620	REC3858261	624
3854874	RM3854874	664
3854942	REC17921	647
3855079	SHEG9903	637
3855184	REC8M0125617	630
3855269	REC3855269	667
3855271	REC3855271	667
3855411	CM3855411	681
3855411	REC3851411	672
3855411	REC3863193AL	672
3855991	REC46-8M0113735	671
3856138	REC17982	649-651
3856443	REC17903	645
3857532	REC8M0068784	630
3857533	REC3857533	633
3857675	REC3857675	681
3857723	MAR501	666
3857794	SHEG9903	637
3857944	MAR061	664-666-668
3857986	REC3858261	624
3858261	REC3858261	624
3858340	REC46-8M0113733	671
3858462	REC3858462	691
3858847	SHEG9901	637
3860566	REC50-863007A1	632
3860566	REC50-99418A2	632
3860842	REC3860842	680
3861459	RM3861459	668
3862500	REC3862500	664-666
3863090	REC3863090	681
3863191	REC3863191	665-666-667-668
5000074	REC5000074	679-685
5004257	REC5004257	679
5004765	REC5004765	679
5004941	REC320635	684
5005034	REC5005034	699
5008966	REC314503	685
5008966	REC398042	699
5008966	REC398042	679-681
21533394	REC21533394	627
10-812509184	MP0180-001	632
10-861788	REC10-861788	632
17177A1	REC17177A1	640
22-89771Q2	GS31066	620-622
311606C	REC3852106	692
35-60494A4	REC24950	619
35-802893Q4	RAC320R-RAC-02	619-620
35-809097	LENS3213	620
35-809097	RACS3213	620
35-809099	RACS3214	620
35-809101	RACS3220UL	619-620
35-886638	LENS3227	620
35-886638	RACS3227	620
3789161GM	REC27-8146801	689
3850301-7	SOL8611-145-19	697
3850301-7	SOL8613-143-19	697
3850322-3	SOL8652-145-21	697
3855479-6	SOL8612-150-15	697
3855479-6	SOL8614-148-15	697
3855480-4	SOL8612-148-17	697
3855480-4	SOL8614-145-17	697
3855481-2	SOL8612-145-19	697
3855481-2	SOL8614-143-19	697



ES

GUÍA MANTENIMIENTO DE MOTORES	710	KIT JUNTAS DEL ENFRIADOR DE AIRE	738	KITS PISTONES	758
<b>SISTEMA ALIMENTACIÓN Y FILTRACIÓN</b>	<b>716</b>	GUÍA	738	KITS AROS DE PISTONES	758
ACCESORIOS PARA FILTROS	725	KIT JUNTAS DEL ENFRIADOR DE ACEITE	741	KITS COJINETES AXIALES	761
BOMBA DE COMBUSTIBLE	725	GUÍA	742	KITS COJINETES BANCADA	759
BOMBA DE COMBUSTIBLE MECÁNICA	725	KIT JUNTAS DEL ENFRIADOR DE AGUA	739	KITS COJINETES BANCADA CENTRAL	759
FILTRO DE ACEITE	721	GUÍA	740	KITS COJINETES BANCADA DELANTEROS	760
JUNTA BOMBA ACEITE	722	TERMOSTATO	734	KITS COJINETES BANCADA TRASEROS	760
JUNTA SOPORTE FILTRO ACEITE	722	JUNTAS	735	KITS COJINETES BIELA	760
FILTRO DE AIRE	723	<b>PARTES DEL MOTOR</b>	<b>743</b>	RETENES CIGÜEÑAL	757
FILTRO DE COMBUSTIBLE Y ELEMENTOS	716	ARANDELAS	755	VÁLVULAS	762
FILTRO DECANTADOR - DIESEL	718	JUNTAS DE MOTOR	743	RETENES	762
FILTRO GASOLINA	716	IMPULSORES	753	<b>SISTEMA ESCAPE Y ADMISIÓN</b>	<b>764</b>
MANGUERA CARBURANTE	723	JUNTAS BOMBA COMBUSTIBLE	752	CODOS	764
RACORES	724	JUNTAS CARTER	752	CODOS ESCAPE INOX	765
TURBO	726	JUNTAS CODO ESCAPE	750	<b>UNIDADES DE TRANSMISIÓN</b>	<b>767</b>
<b>SISTEMA ELÉCTRICO</b>	<b>729</b>	JUNTAS COLECTOR ADMISIÓN	749	ÁNODOS	767
ALTERNADORES	731	JUNTAS COLECTOR ESCAPE	749	ÁNODO CANADA METAL	771
CORREAS	732	JUNTAS CULATA	743	ÁNODO TECNOSEAL	769
MOTORES DE ARRANQUE	730	JUNTAS TAPA ADMISIÓN	749	ÁNODO RECMAR	767
SENSORES	729	JUNTAS TAPA ANODO	751	KITS RETENES TRANSMISIÓN	772
SOLENOIDE RELÉ	733	JUNTAS TAPA BALANCINES	748	SOPORTE MOTOR	771
SOLENOIDE	733	JUNTAS TAPA BOMBA	752	<b>SISTEMA DE PROPULSIÓN</b>	<b>774</b>
RELÉ	733	JUNTAS TAPA ESCAPE	750	HÉLICES AL E INOX DE 3 Y 4 PALAS	774
<b>SISTEMA DE REFRIGERACIÓN</b>	<b>734</b>	JUNTAS TAPA RESPIERADERO	751	REF --> RO	776
BOMBA ASPIRACIÓN DE AGUA	735	JUNTAS TAPA RETÉN DELANTERO	753	RO --> REF	779
CORREA DE LA BOMBA	737	JUNTAS TAPA RETÉN TRASERO	753		
JUNTAS DE LA BASE	736	JUNTAS TAPA VARILLA ACEITE	751		
JUNTAS DE LA BOMBA	737	JUNTAS TURBO	750		
		KITS CON JUNTA CULATA	745		
		KITS SIN JUNTA CULATA	748		
		RETÉN TAPA BLOQUE	751		
		RETÉN TAPA LATERAL BLOQUE	751		

EN

GUIDE: ENGINE MAINTENANCE	710	OIL COOLER GASKETS	741	PISTONS KIT	758
<b>FUEL &amp; FILTRATION SYSTEM</b>	<b>716</b>	GUIDE	742	AXIAL BEARING KIT	758
AIR FILTER	723	RAW MARINE WATER PUMP	735	CONNECTING ROD BEARING KITS	760
FILTER ACCESSORIES	725	GASKETS PUMP	736	MAIN BEARING KITS	759
FUEL FILTER AND ELEMENTS	716	PUMPS BASE GASKET	736	MAIN BEARING KITS CENTRAL	759
COMPLETE DIESEL FILTER	718	PUMPS BELT	737	MAIN BEARING KITS FRONT	760
FUEL FILTER	716	THERMOSTAT	734	MAIN BEARING KITS REAR	760
FUEL HOSE	723	GASKETS	735	PISTONS RINGS SET	758
FUEL PUMP	725	<b>ENGINE PARTS</b>	<b>743</b>	VALVE	762
MECHANICAL FUEL PUMP	725	CRANKSHAFT SEAL	757	VALVE STEM SEALS	762
OIL FILTER	721	ENGINE GASKETS	743	WASHERS	755
OIL FILTER SUPPORT GASKET	722	BREATHER COVER GASKET	751	<b>EXHAUST &amp; INTAKE SYSTEM</b>	<b>764</b>
OIL PUMP GASKETS	722	COVER GASKET ANODE	751	ELBOWS	764
RACORES	724	COVER GASKET OIL DISPTICK	751	SS ELBOWS	765
TURBO	726	CYLINDER HEAD GASKETS	743	<b>TRANSMISSION UNIT</b>	<b>767</b>
<b>ELECTRIC SYSTEM</b>	<b>729</b>	EXHAUST COVER GASKET	750	ANODE	767
ALTERNATORS	731	EXHAUST ELBOW GASKET	750	CANADA METAL	771
BELTS	732	EXHAUST MANIFOLD GASKET	749	TECNOSEAL	769
STARTERS	730	FRONT SEAL COVER GASKET	753	RECMAR	767
SENSORS	729	FUEL PUMP GASKET	752	ENGINE MOUNT SCREW	771
SOLENOID & RELAY	733	IMPELLERS	753	TRANSMISSION SEAL KIT	772
SOLENOID	733	INTAKE COVER GASKET	749	<b>PROPULSION SYSTEM</b>	<b>774</b>
RELAY	733	INTAKE MANIFOLD GASKET	749	3 & 4 BLADE AL & SS PROPELLERS	774
<b>COOLING SYSTEM</b>	<b>734</b>	KITS WITH HEAD GASKET	745	REF --> RO	776
AIRCOOLER GASKETS	738	KITS WITHOUT HEAD GASKET	748	RO --> REF	779
GUIDE	738	OIL PAN GASKET	752		
COOLER GASKETS	739	PUMP COVER GASKET	752		
GUIDE	740	REAR SEAL COVER GASKET	753		
		SEAL COVER BLOCK	751		
		SEAL SIDE COVER BLOCK	751		
		TURBO GASKETS	750		
		VALVE COVER GASKETS	748		



# YANMAR

IT

GUIDA MANUTENZIONE MOTORI	710	POMPE ASPIRAZIONE ACQUA MARINA	735	KIT BRONZE DI BANCO ANTERIORE	760
<b>SISTEMA DI ALIMENTAZIONE E FILTRAZIONE</b>	<b>716</b>	CINGHIE POMPA	737	KIT BRONZE DI BANCO CENTRO	759
ACCESSORI PER FILTRI	725	GUARNIZIONE BASE POMPA	736	KIT BRONZE DI BANCO POSTERIORE	760
POMPA COMBUSTIBILE	725	GUARNIZIONE POMPA	737	KIT BRONZE DI BIELLA	760
POMPA MECCANICA	725	TERMOSTATO	734	KIT FASCE PISTONI	758
FILTRO OLIO	721	GUARNIZIONE	735	PARAOLIO ALBERO MOTORE	757
GUARNIZIONE POMPE OLIO	721	<b>PARTI MOTORE</b>	<b>743</b>	RONDELLE	755
GUARNIZIONE SUPPORTO FILTRO	721	GUARNIZIONE MOTORE	743	VALVOLA	762
FILTRO ARIA	723	COLLETTORE ASPIRAZIONE	749	PARAOLIO	762
FILTRI BENZINA	716	COLLETTORE SCARICO	749	<b>SISTEMA DI SCARICO E ASPIRAZIONE</b>	<b>764764</b>
FILTRO DECANTATORE - DIESEL	718	COPERCHIO ANODO	751	GOMITI	764
FILTRO BENZINA	716	COPERCHIO ASPIRAZIONE	749	GOMITO SCARICO INOSS	765
TUBO DI CARBURANTE	723	COPERCHIO ASTA DI OLIO	751	<b>UNITÀ DI TRASMISSIONE</b>	<b>767</b>
RACCORDI	724	COPERCHIO BLOCCO	743	ANODI	767
TURBINE	726	COPERCHIO LATERALE	751	ANODI CANADA METAL	771
<b>SISTEMA ELETTRICO</b>	<b>729</b>	COPERCHIO PARAOLIO ANTERIORE	753	ANODI TECNOSEAL	769
ALTERNATORI	731	COPERCHIO PARAOLIO POSTERIORE	753	ANODI RECMAR	767
CINGHIE	732	COPERCHIO POMPA	752	SUPPORTI MOTORE	771
MOTORINI AVVIAMENTO	730	COPERCHIO PUNTERIE	748	KIT GUARNIZIONE TRASMISSIONE	772
SENSORE	729	COPERCHIO SCARICO	750	<b>SISTEMA DI PROPULSIONE</b>	<b>774</b>
SOLENOIDI E RELÉ	733	COPERCHIO SFATATOIO	751	ELICHE ALLUMINIO E INOX DA 3 E 4 PALE	774
SOLENOIDE	733	COPPA DELL'OLIO	752	REF --> RO	776
RELÉ POMPA ELETTRICA	733	GIRANTI	753	RO --> REF	779
<b>SISTEMA DI RAFFREDDAMENTO</b>	<b>734</b>	GOMITO DI SCARICO	750		
KIT GUARNIZIONE RAFFREDDATORE ACQUA	739	KIT CON GUARNIZIONE TESTATA	744		
GUIDA	740	KIT SENZA GUARNIZIONE TESTATA	748		
KIT GUARNIZIONE RAFFREDDATORE ARIA	738	POMPA COMBUSTIBILE	752		
GUIDA	738	TESTATA	743		
KIT GUARNIZIONE RAFFREDDATORE OLIO	741	KIT PISTONI	758		
GUIDA	742	KIT BRONZE ASSIAL	761		
		KIT BRONZE DI BANCO	759		

FR

GUIDE MAINTENANCE MOTEURS	710	POMPE D'EAU MARINE	735	KITS COUSSINET VILEBR. AVANT-ARRIERE	
<b>SYSTÈME D'ALIMENTATION ET DE FILTRATION</b>	<b>716</b>	JOINTS BASE DE LA POMPE	736	KITS COUSSINET VILEBREQUIN	
ACCESSOIRES POUR FILTRES	725	JOINTS POMPE	737	KITS COUSSINET VILEBREQUIN CENTRAL	
FILTRE À AIRE	723	COURROIES DE LA POMPE	737	KITS ROULEMENT AXIAL	
FILTRE À ESSENCE ET CARTOUCHE DE RECHANGE	716	THERMOSTAT	734	KITS ROULEMENT DE BIELLE	
FILTRE À ESSENCE	716	JOINTS	735	KITS SEGMENTS DE PISTONS	
FILTRE DÉCANTATEUR - DIESEL	718	<b>PIECES MOTEUR</b>	<b>743</b>	RONDELLES	
FILTRE À HUILE	721	JOINTS MOTEUR		SOUPAPES	
JOINTS POMPE D'HUILE	722	JOINS COUVER-SOUPAPE		JOINTS D'HUILE	
JOINTS SUPPORT FILTRE	722	JOINT CARTER		<b>SYSTÈME D'ÉCHAPPEMENT ET D'AMMISSION</b>	
POMPE À ESSENCE MECANIQUE	725	JOINT CARTER ADMISSION		COUDES	
RACCORDS	724	JOINT COLECTEUR D'ÉCHAPPEMENT		COUDES D'ÉCHAPPEMENT INOX	
TURBO	726	JOINT COUVERCLE D'ÉCHAPPEMENT		<b>EMBASES ET PIÈCES</b>	<b>767</b>
TUYAU DU CARBURANT	723	JOINT COUVERCLE ADMISSION		ANODES	
<b>SYSTÈME ÉLECTRIQUE</b>	<b>729</b>	JOINT COUVERCLE ANODE		ANODES CANADA METAL	
ALTERNATEUR	731	JOINT COUVERCLE D'ÉCHAPPEMENT		ANODES TECNOSEAL	
COURROIES	732	JOINT COUVERCLE D'HUILE		KIT JOINT D'EMBASE	
CAPTEURS	729	JOINT COUVERCLE DU BLOC		SUPPORT MOTEUR	
DÉMARREUR	730	JOINT COUVERCLE LATERAL DU BLOC		<b>SYSTÈME DE PROPULSION</b>	<b>774</b>
SOLENOIDE RELAIS	733	JOINT COUVERCLE POMPA		HÉLICE ALUMINIUM ET INOX 3 ET 4 PALES	774
<b>SYSTÈME DE REFROIDISSEMENT</b>	<b>734</b>	JOINT CULASSE		REF --> RO	776
KIT JOINTS REFFROIDISSEURS AIR	738	JOINT DE PLAQUE		RO --> REF	779
GUIDE	738	JOINT DE PLAQUE AVANT			
KIT JOINTS REFFROIDISSEURS EAU	739	JOINT SPI COUVERCLE ARRIÈRE			
GUIDE	740	JOINT TURBO			
KIT JOINTS REFFROIDISSEURS HUILE	741	KITS AVEC JOINT DE CULASSE			
GUIDE	742	KITS SANS JOINT DE CULASSE			
		TURBINES			
		JOINTS VILEBREQUIN			
		KITS PISTONS			

YANMAR

RECAMBIOS  
MARINOS





## REF

3GM30	REC119305-35151	FILTRO ACEITE	OIL FILTER	FILTRO OLIO	FILTRE D'HUILE
	REC104500-55710	FILTRO COMBUSTIBLE	FUEL FILTER	FILTRO COMBUSTIBILE	FILTRE CARBURANT
	REC128270-12540	FILTRO AIRE	AIR FILTER	FILTRO ARIA	FILTRE D'AIRE
	REC3586494	IMPULSOR	IMPELLER	GIRANTE	TURBINE
	REC105582-49200	TERMOSTATO	THERMOSTAT	TERMOSTATO	THERMOSTAT
3GM30F	CMC272100-20030	ÁNODO	ANODE	ANODO	ANODE
	REC119305-35151	FILTRO ACEITE	OIL FILTER	FILTRO OLIO	FILTRE D'HUILE
	REC104500-55710	FILTRO COMBUSTIBLE	FUEL FILTER	FILTRO COMBUSTIBILE	FILTRE CARBURANT
	REC128270-12540	FILTRO AIRE	AIR FILTER	FILTRO ARIA	FILTRE D'AIRE
	REC22779-0001	IMPULSOR	IMPELLER	GIRANTE	TURBINE
	REC121750-49800	TERMOSTATO	THERMOSTAT	TERMOSTATO	THERMOSTAT
3GM30F-YEU	REC104511-78780E	CORREA ALTERNADOR	ALTERNATOR BELT	CINGHIA ALTERNATORE	COUROIE ALTERNATEUR
	REC119305-35151	FILTRO ACEITE	OIL FILTER	FILTRO OLIO	FILTRE D'HUILE
	REC104500-55710	FILTRO COMBUSTIBLE	FUEL FILTER	FILTRO COMBUSTIBILE	FILTRE CARBURANT
	REC128270-12540	FILTRO AIRE	AIR FILTER	FILTRO ARIA	FILTRE D'AIRE
	REC653-0001	IMPULSOR	IMPELLER	GIRANTE	TURBINE
	REC121750-49800	TERMOSTATO	THERMOSTAT	TERMOSTATO	THERMOSTAT
3HM	REC25132-003700	CORREA ALTERNADOR	ALTERNATOR BELT	CINGHIA ALTERNATORE	COUROIE ALTERNATEUR
	REC104511-78780E	CORREA BOMBA	PUMP BELT	CINGHIA POMPA	COURROIE POMPE
	REC124550-35110	FILTRO ACEITE	OIL FILTER	FILTRO OLIO	FILTRE D'HUILE
	REC104500-55710	FILTRO COMBUSTIBLE	FUEL FILTER	FILTRO COMBUSTIBILE	FILTRE CARBURANT
	REC128270-12540	FILTRO AIRE	AIR FILTER	FILTRO ARIA	FILTRE D'AIRE
	REC22779-0001	IMPULSOR	IMPELLER	GIRANTE	TURBINE
3HM35	REC105582-49200	TERMOSTATO	THERMOSTAT	TERMOSTATO	THERMOSTAT
	REC128670-77350	CORREA ALTERNADOR	ALTERNATOR BELT	CINGHIA ALTERNATORE	COUROIE ALTERNATEUR
	REC104511-78780E	CORREA BOMBA	PUMP BELT	CINGHIA POMPA	COURROIE POMPE
	CMC272100-20030	ÁNODO	ANODE	ANODO	ANODE
	REC124550-35110	FILTRO ACEITE	OIL FILTER	FILTRO OLIO	FILTRE D'HUILE
	REC104500-55710	FILTRO COMBUSTIBLE	FUEL FILTER	FILTRO COMBUSTIBILE	FILTRE CARBURANT
3HMF	REC128270-12540	FILTRO AIRE	AIR FILTER	FILTRO ARIA	FILTRE D'AIRE
	REC22779-0001	IMPULSOR	IMPELLER	GIRANTE	TURBINE
	REC105582-49200	TERMOSTATO	THERMOSTAT	TERMOSTATO	THERMOSTAT
	REC128695-44780	CORREA ALTERNADOR	ALTERNATOR BELT	CINGHIA ALTERNATORE	COUROIE ALTERNATEUR
	REC104511-78780E	CORREA BOMBA	PUMP BELT	CINGHIA POMPA	COURROIE POMPE
	CMC272100-20030	ÁNODO	ANODE	ANODO	ANODE
3JH2	REC119305-35151	FILTRO ACEITE	OIL FILTER	FILTRO OLIO	FILTRE D'HUILE
	REC129470-55703	FILTRO COMBUSTIBLE	FUEL FILTER	FILTRO COMBUSTIBILE	FILTRE CARBURANT
	REC21213660	IMPULSOR	IMPELLER	GIRANTE	TURBINE
	REC129470-49801	TERMOSTATO	THERMOSTAT	TERMOSTATO	THERMOSTAT
	REC25132-004500	CORREA ALTERNADOR	ALTERNATOR BELT	CINGHIA ALTERNATORE	COUROIE ALTERNATEUR
3JH25A	REC129150-35153	FILTRO ACEITE	OIL FILTER	FILTRO OLIO	FILTRE D'HUILE
	REC129470-55703	FILTRO COMBUSTIBLE	FUEL FILTER	FILTRO COMBUSTIBILE	FILTRE CARBURANT
	REC21213660	IMPULSOR	IMPELLER	GIRANTE	TURBINE
	REC129470-49801	TERMOSTATO	THERMOSTAT	TERMOSTATO	THERMOSTAT
	REC25132-004500	CORREA ALTERNADOR	ALTERNATOR BELT	CINGHIA ALTERNATORE	COUROIE ALTERNATEUR
3JH2E 3JH2L	REC119305-35151	FILTRO ACEITE	OIL FILTER	FILTRO OLIO	FILTRE D'HUILE
	REC129470-55703	FILTRO COMBUSTIBLE	FUEL FILTER	FILTRO COMBUSTIBILE	FILTRE CARBURANT
	REC129470-49801	IMPULSOR	IMPELLER	GIRANTE	TURBINE
	REC105582-49200	TERMOSTATO	THERMOSTAT	TERMOSTATO	THERMOSTAT
	REC25132-004500	CORREA ALTERNADOR	ALTERNATOR BELT	CINGHIA ALTERNATORE	COUROIE ALTERNATEUR
3JH2-TCE	REC119305-35151	FILTRO ACEITE	OIL FILTER	FILTRO OLIO	FILTRE D'HUILE
	REC129470-55703	FILTRO COMBUSTIBLE	FUEL FILTER	FILTRO COMBUSTIBILE	FILTRE CARBURANT
	REC129470-12330	FILTRO AIRE	AIR FILTER	FILTRO ARIA	FILTRE D'AIRE
	REC21213660	IMPULSOR	IMPELLER	GIRANTE	TURBINE
	REC129470-49801	TERMOSTATO	THERMOSTAT	TERMOSTATO	THERMOSTAT
3JH3	REC25132-004500	CORREA ALTERNADOR	ALTERNATOR BELT	CINGHIA ALTERNATORE	COUROIE ALTERNATEUR
	REC129150-35151	FILTRO ACEITE	OIL FILTER	FILTRO OLIO	FILTRE D'HUILE
	REC129470-55703	FILTRO COMBUSTIBLE	FUEL FILTER	FILTRO COMBUSTIBILE	FILTRE CARBURANT
	REC21213660	IMPULSOR	IMPELLER	GIRANTE	TURBINE
	REC129470-49801	TERMOSTATO	THERMOSTAT	TERMOSTATO	THERMOSTAT
3JH3E-YEU-E 3JH4E	REC25132-004500	CORREA ALTERNADOR	ALTERNATOR BELT	CINGHIA ALTERNATORE	COUROIE ALTERNATEUR
	REC119305-35151	FILTRO ACEITE	OIL FILTER	FILTRO OLIO	FILTRE D'HUILE
	REC129470-55703	FILTRO COMBUSTIBLE	FUEL FILTER	FILTRO COMBUSTIBILE	FILTRE CARBURANT
	REC21213660	IMPULSOR	IMPELLER	GIRANTE	TURBINE
	REC129470-49801	TERMOSTATO	THERMOSTAT	TERMOSTATO	THERMOSTAT
3YM20	REC129940-42310E	CORREA ALTERNADOR	ALTERNATOR BELT	CINGHIA ALTERNATORE	COUROIE ALTERNATEUR
	REC119305-35151	FILTRO ACEITE	OIL FILTER	FILTRO OLIO	FILTRE D'HUILE
	REC104500-55710	FILTRO COMBUSTIBLE	FUEL FILTER	FILTRO COMBUSTIBILE	FILTRE CARBURANT
	REC128270-12540	FILTRO AIRE	AIR FILTER	FILTRO ARIA	FILTRE D'AIRE
	REC653-0001	IMPULSOR	IMPELLER	GIRANTE	TURBINE
3YM20	REC128990-49800	TERMOSTATO	THERMOSTAT	TERMOSTATO	THERMOSTAT
	REC129612-42290E	CORREA ALTERNADOR	ALTERNATOR BELT	CINGHIA ALTERNATORE	COUROIE ALTERNATEUR



## REF

	REF				
3YM27A	REC119305-35151	FILTRO ACEITE	OIL FILTER	FILTRO OLIO	FILTRE D'HUILE
	REC104500-55710	FILTRO COMBUSTIBLE	FUEL FILTER	FILTRO COMBUSTIBILE	FILTRE CARBURANT
	REC128991-12500	FILTRO AIRE	AIR FILTER	FILTRO ARIA	FILTRE D'AIRE
	REC128991-42200	IMPULSOR	IMPELLER	GIRANTE	TURBINE
	REC128990-49800	TERMOSTATO	THERMOSTAT	TERMOSTATO	THERMOSTAT
3YM30	REC104511-78780E	CORREA ALTERNADOR	ALTERNATOR BELT	CINGHIA ALTERNATORE	COUROIE ALTERNATEUR
	REC119305-35151	FILTRO ACEITE	OIL FILTER	FILTRO OLIO	FILTRE D'HUILE
	REC104500-55710	FILTRO COMBUSTIBLE	FUEL FILTER	FILTRO COMBUSTIBILE	FILTRE CARBURANT
	REC128270-12540	FILTRO AIRE	AIR FILTER	FILTRO ARIA	FILTRE D'AIRE
	REC653-0001	IMPULSOR	IMPELLER	GIRANTE	TURBINE
	REC128990-49800	TERMOSTATO	THERMOSTAT	TERMOSTATO	THERMOSTAT
	REC128990-77350	CORREA BOMBA	PUMP BELT	CINGHIA POMPA	COURROIE POMPE
3YM30AE	CMC272100-20030	ÁNODO	ANODE	ANODO	ANODE
	REC119305-35151	FILTRO ACEITE	OIL FILTER	FILTRO OLIO	FILTRE D'HUILE
	REC104500-55710	FILTRO COMBUSTIBLE	FUEL FILTER	FILTRO COMBUSTIBILE	FILTRE CARBURANT
	REC128270-12540	FILTRO AIRE	AIR FILTER	FILTRO ARIA	FILTRE D'AIRE
	JOH09-810B	IMPULSOR	IMPELLER	GIRANTE	TURBINE
	REC121750-49800	TERMOSTATO	THERMOSTAT	TERMOSTATO	THERMOSTAT
4CH-DT	REC128695-44780	CORREA ALTERNADOR	ALTERNATOR BELT	CINGHIA ALTERNATORE	COUROIE ALTERNATEUR
	REC127695-35150	FILTRO ACEITE	OIL FILTER	FILTRO OLIO	FILTRE D'HUILE
	REC41650-502330	FILTRO COMBUSTIBLE	FUEL FILTER	FILTRO COMBUSTIBILE	FILTRE CARBURANT
	CEF500114T	IMPULSOR	IMPELLER	GIRANTE	TURBINE
	REC123682-48601	TERMOSTATO	THERMOSTAT	TERMOSTATO	THERMOSTAT
4JH	REC124722-42290	CORREA ALTERNADOR	ALTERNATOR BELT	CINGHIA ALTERNATORE	COUROIE ALTERNATEUR
	REC104511-78780E	CORREA BOMBA	PUMP BELT	CINGHIA POMPA	COURROIE POMPE
	CMC272100-20030	ÁNODO	ANODE	ANODO	ANODE
	REC129150-35150	FILTRO ACEITE	OIL FILTER	FILTRO OLIO	FILTRE D'HUILE
	REC41650-502320	FILTRO COMBUSTIBLE	FUEL FILTER	FILTRO COMBUSTIBILE	FILTRE CARBURANT
3HMF	REC129470-42531	IMPULSOR	IMPELLER	GIRANTE	TURBINE
	REC129470-49801	TERMOSTATO	THERMOSTAT	TERMOSTATO	THERMOSTAT
	REC25132-004500	CORREA ALTERNADOR	ALTERNATOR BELT	CINGHIA ALTERNATORE	COUROIE ALTERNATEUR
	REC104511-78780E	CORREA BOMBA	PUMP BELT	CINGHIA POMPA	COURROIE POMPE
	REC124550-35110	FILTRO ACEITE	OIL FILTER	FILTRO OLIO	FILTRE D'HUILE
	REC104500-55710	FILTRO COMBUSTIBLE	FUEL FILTER	FILTRO COMBUSTIBILE	FILTRE CARBURANT
	REC128270-12540	FILTRO AIRE	AIR FILTER	FILTRO ARIA	FILTRE D'AIRE
	REC22779-0001	IMPULSOR	IMPELLER	GIRANTE	TURBINE
	REC105582-49200	TERMOSTATO	THERMOSTAT	TERMOSTATO	THERMOSTAT
4JH2-DTE	REC128695-44780	CORREA ALTERNADOR	ALTERNATOR BELT	CINGHIA ALTERNATORE	COUROIE ALTERNATEUR
	REC104511-78780E	CORREA BOMBA	PUMP BELT	CINGHIA POMPA	COURROIE POMPE
	CMC272100-20030	ÁNODO	ANODE	ANODO	ANODE
	REC129150-35153	FILTRO ACEITE	OIL FILTER	FILTRO OLIO	FILTRE D'HUILE
	REC129470-55703	FILTRO COMBUSTIBLE	FUEL FILTER	FILTRO COMBUSTIBILE	FILTRE CARBURANT
4JH2E 4JH2-HTE 4JH2-TE	REC129470-12330	FILTRO AIRE	AIR FILTER	FILTRO ARIA	FILTRE D'AIRE
	REC21213660	IMPULSOR	IMPELLER	GIRANTE	TURBINE
	REC129470-49801	TERMOSTATO	THERMOSTAT	TERMOSTATO	THERMOSTAT
	REC25132-004600	CORREA ALTERNADOR	ALTERNATOR BELT	CINGHIA ALTERNATORE	COUROIE ALTERNATEUR
	REC129150-35153	FILTRO ACEITE	OIL FILTER	FILTRO OLIO	FILTRE D'HUILE
4JH2-UTE 4JH3-TE	REC129574-55711	FILTRO COMBUSTIBLE	FUEL FILTER	FILTRO COMBUSTIBILE	FILTRE CARBURANT
	REC129470-12330	FILTRO AIRE	AIR FILTER	FILTRO ARIA	FILTRE D'AIRE
	REC21213660	IMPULSOR	IMPELLER	GIRANTE	TURBINE
	REC129470-49801	TERMOSTATO	THERMOSTAT	TERMOSTATO	THERMOSTAT
	REC25132-004600	CORREA ALTERNADOR	ALTERNATOR BELT	CINGHIA ALTERNATORE	COUROIE ALTERNATEUR
4JH3-DTE	REC129150-35153	FILTRO ACEITE	OIL FILTER	FILTRO OLIO	FILTRE D'HUILE
	REC129574-55711	FILTRO COMBUSTIBLE	FUEL FILTER	FILTRO COMBUSTIBILE	FILTRE CARBURANT
	REC129470-12330	FILTRO AIRE	AIR FILTER	FILTRO ARIA	FILTRE D'AIRE
	REC129670-42531	IMPULSOR	IMPELLER	GIRANTE	TURBINE
	REC129470-49801	TERMOSTATO	THERMOSTAT	TERMOSTATO	THERMOSTAT
	REC25132-004600	CORREA ALTERNADOR normal	ALTERNATOR BELT normal	CINGHIA ALTERNATORE normal	COUROIE ALTERNATEUR normal
4JH3-HTE	REC129673-77680	CORREA ALTERNADOR serpentin	ALTERNATOR BELT serpentine	CINGHIA ALTERNATORE serpentina	COUROIE ALTERNATEUR serpentine
	REC129150-35153	FILTRO ACEITE	OIL FILTER	FILTRO OLIO	FILTRE D'HUILE
	REC129574-55711	FILTRO COMBUSTIBLE	FUEL FILTER	FILTRO COMBUSTIBILE	FILTRE CARBURANT
	REC129470-12330	FILTRO AIRE	AIR FILTER	FILTRO ARIA	FILTRE D'AIRE
	REC21213660	IMPULSOR	IMPELLER	GIRANTE	TURBINE
	REC129470-49801	TERMOSTATO	THERMOSTAT	TERMOSTATO	THERMOSTAT
4JH4E	REC25132-004600	CORREA ALTERNADOR normal	ALTERNATOR BELT normal	CINGHIA ALTERNATORE normal	COUROIE ALTERNATEUR normal
	REC129673-77680	CORREA ALTERNADOR serpentin	ALTERNATOR BELT serpentine	CINGHIA ALTERNATORE serpentina	COUROIE ALTERNATEUR serpentine
	REC129150-35153	FILTRO ACEITE	OIL FILTER	FILTRO OLIO	FILTRE D'HUILE
	REC129470-55703	FILTRO COMBUSTIBLE	FUEL FILTER	FILTRO COMBUSTIBILE	FILTRE CARBURANT
	REC21213660	IMPULSOR	IMPELLER	GIRANTE	TURBINE
	REC129470-49801	TERMOSTATO	THERMOSTAT	TERMOSTATO	THERMOSTAT
	REC25152-004300	CORREA ALTERNADOR	ALTERNATOR BELT	CINGHIA ALTERNATORE	COUROIE ALTERNATEUR





## REF

4JH-DTE	REC129150-35153	FILTRO ACEITE	OIL FILTER	FILTRO OLIO	FILTRE D'HUILE
	REC129470-55703	FILTRO COMBUSTIBLE	FUEL FILTER	FILTRO COMBUSTIBILE	FILTRE CARBURANT
	REC21213660	IMPULSOR	IMPELLER	GIRANTE	TURBINE
	REC129470-49801	TERMOSTATO	THERMOSTAT	TERMOSTATO	THERMOSTAT
4JHE	REC25132-004600	CORREA ALTERNADOR	ALTERNATOR BELT	CINGHIA ALTERNATORE	COUROIE ALTERNATEUR
	REC129150-35153	FILTRO ACEITE	OIL FILTER	FILTRO OLIO	FILTRE D'HUILE
	REC129470-55703	FILTRO COMBUSTIBLE	FUEL FILTER	FILTRO COMBUSTIBILE	FILTRE CARBURANT
	REC129470-12330	FILTRO AIRE	AIR FILTER	FILTRO ARIA	FILTRE D'AIRE
	REC21213660	IMPULSOR	IMPELLER	GIRANTE	TURBINE
4JH-HTE	REC129470-49801	TERMOSTATO	THERMOSTAT	TERMOSTATO	THERMOSTAT
	REC25132-004600	CORREA ALTERNADOR	ALTERNATOR BELT	CINGHIA ALTERNATORE	COUROIE ALTERNATEUR
	REC129150-35153	FILTRO ACEITE	OIL FILTER	FILTRO OLIO	FILTRE D'HUILE
	REC129470-55703	FILTRO COMBUSTIBLE	FUEL FILTER	FILTRO COMBUSTIBILE	FILTRE CARBURANT
	REC21213660	IMPULSOR	IMPELLER	GIRANTE	TURBINE
4JH-HTZ 4JH-HTZAE	REC129470-49801	TERMOSTATO	THERMOSTAT	TERMOSTATO	THERMOSTAT
	REC25132-004500	CORREA ALTERNADOR	ALTERNATOR BELT	CINGHIA ALTERNATORE	COUROIE ALTERNATEUR
	REC129150-35150	FILTRO ACEITE	OIL FILTER	FILTRO OLIO	FILTRE D'HUILE
	REC129470-55703	FILTRO COMBUSTIBLE	FUEL FILTER	FILTRO COMBUSTIBILE	FILTRE CARBURANT
	REC21213660	IMPULSOR	IMPELLER	GIRANTE	TURBINE
4JH-TE 4JH-TZ	REC129470-49801	TERMOSTATO	THERMOSTAT	TERMOSTATO	THERMOSTAT
	REC25132-004500	CORREA ALTERNADOR	ALTERNATOR BELT	CINGHIA ALTERNATORE	COUROIE ALTERNATEUR
	REC129150-35150	FILTRO ACEITE	OIL FILTER	FILTRO OLIO	FILTRE D'HUILE
	REC41650-502320	FILTRO COMBUSTIBLE	FUEL FILTER	FILTRO COMBUSTIBILE	FILTRE CARBURANT
	REC21213660	IMPULSOR	IMPELLER	GIRANTE	TURBINE
2GMSZK	REC129470-12330	FILTRO AIRE	AIR FILTER	FILTRO ARIA	FILTRE D'AIRE
	REC129470-49801	TERMOSTATO	THERMOSTAT	TERMOSTATO	THERMOSTAT
	REC25132-004500	CORREA ALTERNADOR	ALTERNATOR BELT	CINGHIA ALTERNATORE	COUROIE ALTERNATEUR
	REC119305-35151	FILTRO ACEITE	OIL FILTER	FILTRO OLIO	FILTRE D'HUILE
	REC121750-55701	FILTRO COMBUSTIBLE	FUEL FILTER	FILTRO COMBUSTIBILE	FILTRE CARBURANT
	REC128270-12540	FILTRO AIRE	AIR FILTER	FILTRO ARIA	FILTRE D'AIRE
	REC3586494	IMPULSOR	IMPELLER	GIRANTE	TURBINE
	REC105582-49200	TERMOSTATO	THERMOSTAT	TERMOSTATO	THERMOSTAT
4LHA-DTE, -DTP, -DTZE, -DTZP, -HTE, -HTP, -HTZE, -HTZP, -STE, -STP, -STZE	REC25132-003000	CORREA ALTERNADOR	ALTERNATOR BELT	CINGHIA ALTERNATORE	COUROIE ALTERNATEUR
	REC128695-42780	CORREA BOMBA	PUMP BELT	CINGHIA POMPA	COUROIE POMPE
	CMC272100-20030	ÁNODO	ANODE	CINGHIA ALTERNATORE	ANODE
	REC127695-35150	FILTRO ACEITE	OIL FILTER	FILTRO OLIO	FILTRE D'HUILE
	REC41650-502320	FILTRO COMBUSTIBLE	FUEL FILTER	FILTRO COMBUSTIBILE	FILTRE CARBURANT
	REC119195-18880	FILTRO AIRE	AIR FILTER	FILTRO ARIA	FILTRE D'AIRE
	REC3841697	IMPULSOR	IMPELLER	GIRANTE	TURBINE
4LHA-STZP	REC121850-49811	TERMOSTATO	THERMOSTAT	TERMOSTATO	THERMOSTAT
	REC121850-42280E	CORREA ALTERNADOR	ALTERNATOR BELT	CINGHIA ALTERNATORE	COUROIE ALTERNATEUR
	TEN01316	ÁNODO	ANODE	ANODO	ANODE
	REC127695-35150	FILTRO ACEITE	OIL FILTER	FILTRO OLIO	FILTRE D'HUILE
	REC41650-502320	FILTRO COMBUSTIBLE	FUEL FILTER	FILTRO COMBUSTIBILE	FILTRE CARBURANT
	REC119195-18880	FILTRO AIRE	AIR FILTER	FILTRO ARIA	FILTRE D'AIRE
	REC3841697	IMPULSOR	IMPELLER	GIRANTE	TURBINE
4LH-DTE, -DTZ, -HT	REC121850-49811	TERMOSTATO	THERMOSTAT	TERMOSTATO	THERMOSTAT
	REC121850-42280E	CORREA ALTERNADOR	ALTERNATOR BELT	CINGHIA ALTERNATORE	COUROIE ALTERNATEUR
	TEN01317	ÁNODO	ANODE	ANODO	ANODE
	REC127695-35150	FILTRO ACEITE	OIL FILTER	FILTRO OLIO	FILTRE D'HUILE
	REC41650-502320	FILTRO COMBUSTIBLE	FUEL FILTER	FILTRO COMBUSTIBILE	FILTRE CARBURANT
	RECXN199611	FILTRO AIRE	AIR FILTER	FILTRO ARIA	FILTRE D'AIRE
	REC3841697	IMPULSOR	IMPELLER	GIRANTE	TURBINE
4LH-HTE	REC121850-49811	TERMOSTATO	THERMOSTAT	TERMOSTATO	THERMOSTAT
	REC121850-42280E	CORREA ALTERNADOR	ALTERNATOR BELT	CINGHIA ALTERNATORE	COUROIE ALTERNATEUR
	TEN01317	ÁNODO	ANODE	ANODO	ANODE
	REC119005-35100	FILTRO ACEITE	OIL FILTER	FILTRO OLIO	FILTRE D'HUILE
	REC121857-55710	FILTRO COMBUSTIBLE	FUEL FILTER	FILTRO COMBUSTIBILE	FILTRE CARBURANT
4LH-HTZ, -HTZAY, STE	RECXN199611	FILTRO AIRE	AIR FILTER	FILTRO ARIA	FILTRE D'AIRE
	REC3841697	IMPULSOR	IMPELLER	GIRANTE	TURBINE
	REC121850-49811	TERMOSTATO	THERMOSTAT	TERMOSTATO	THERMOSTAT
	REC121850-42280E	CORREA ALTERNADOR	ALTERNATOR BELT	CINGHIA ALTERNATORE	COUROIE ALTERNATEUR
	TEN01317	ÁNODO	ANODE	ANODO	ANODE
4LH-ST, -STZ, -STZAY	REC127695-35150	FILTRO ACEITE	OIL FILTER	FILTRO OLIO	FILTRE D'HUILE
	REC41650-502320	FILTRO COMBUSTIBLE	FUEL FILTER	FILTRO COMBUSTIBILE	FILTRE CARBURANT
	REC3841697	IMPULSOR	IMPELLER	GIRANTE	TURBINE
	REC121850-49811	TERMOSTATO	THERMOSTAT	TERMOSTATO	THERMOSTAT
	REC121850-42280E	CORREA ALTERNADOR	ALTERNATOR BELT	CINGHIA ALTERNATORE	COUROIE ALTERNATEUR
TEN01317	ÁNODO	ANODE	ANODO	ANODE	



REF

4LH-TE	REC119005-35100	FILTRO ACEITE	OIL FILTER	FILTRO OLIO	FILTRE D'HUILE
	REC121857-55710	FILTRO COMBUSTIBLE	FUEL FILTER	FILTRO COMBUSTIBILE	FILTRE CARBURANT
	RECXN199611	FILTRO AIRE	AIR FILTER	FILTRO ARIA	FILTRE D'AIRE
	REC3841697	IMPULSOR	IMPELLER	GIRANTE	TURBINE
	REC121850-49811	TERMOSTATO	THERMOSTAT	TERMOSTATO	THERMOSTAT
	REC121850-42280E	CORREA ALTERNADOR	ALTERNATOR BELT	CINGHIA ALTERNATORE	COUROIE ALTERNATEUR
	TEN01317	ÁNODO	ANODE	ANODO	ANODE
4LH-UT, -UTZ, -UTZAY	REC127695-35150	FILTRO ACEITE	OIL FILTER	FILTRO OLIO	FILTRE D'HUILE
	REC41650-502320	FILTRO COMBUSTIBLE	FUEL FILTER	FILTRO COMBUSTIBILE	FILTRE CARBURANT
	REC3841697	IMPULSOR	IMPELLER	GIRANTE	TURBINE
	REC121850-42280E	CORREA ALTERNADOR	ALTERNATOR BELT	CINGHIA ALTERNATORE	COUROIE ALTERNATEUR
	TEN01317	ÁNODO	ANODE	ANODO	ANODE
4LH-WST, -WSTZY	REC127695-35150	FILTRO ACEITE	OIL FILTER	FILTRO OLIO	FILTRE D'HUILE
	REC121850-42280E	CORREA ALTERNADOR	ALTERNATOR BELT	CINGHIA ALTERNATORE	COUROIE ALTERNATEUR
6BY	REC165000-69590	FILTRO ACEITE	OIL FILTER	FILTRO OLIO	FILTRE D'HUILE
	REC120650-55040	FILTRO COMBUSTIBLE	FUEL FILTER	FILTRO COMBUSTIBILE	FILTRE CARBURANT
6CX-ETE	REC127695-35150	FILTRO ACEITE	OIL FILTER	FILTRO OLIO	FILTRE D'HUILE
	REC127695-55630	FILTRO COMBUSTIBLE	FUEL FILTER	FILTRO COMBUSTIBILE	FILTRE CARBURANT
	REC119593-18880	FILTRO AIRE	AIR FILTER	FILTRO ARIA	FILTRE D'AIRE
	REC128620-42201	IMPULSOR	IMPELLER	GIRANTE	TURBINE
	REC123682-48601	TERMOSTATO	THERMOSTAT	TERMOSTATO	THERMOSTAT
	REC25132-004250E	CORREA ALTERNADOR	ALTERNATOR BELT	CINGHIA ALTERNATORE	COUROIE ALTERNATEUR
6CX-GT	REC127695-35150	FILTRO ACEITE	OIL FILTER	FILTRO OLIO	FILTRE D'HUILE
	REC127695-55630	FILTRO COMBUSTIBLE	FUEL FILTER	FILTRO COMBUSTIBILE	FILTRE CARBURANT
	REC119593-18880	FILTRO AIRE	AIR FILTER	FILTRO ARIA	FILTRE D'AIRE
	REC128620-42201	IMPULSOR	IMPELLER	GIRANTE	TURBINE
	REC145640-48410	TERMOSTATO	THERMOSTAT	TERMOSTATO	THERMOSTAT
	REC25132-004250E	CORREA ALTERNADOR	ALTERNATOR BELT	CINGHIA ALTERNATORE	COUROIE ALTERNATEUR
	TEN01312	ÁNODO	ANODE	ANODO	ANODE
6CXM-ETE	REC127695-35150	FILTRO ACEITE	OIL FILTER	FILTRO OLIO	FILTRE D'HUILE
	REC127695-55630	FILTRO COMBUSTIBLE	FUEL FILTER	FILTRO COMBUSTIBILE	FILTRE CARBURANT
	REC119593-18880	FILTRO AIRE	AIR FILTER	FILTRO ARIA	FILTRE D'AIRE
	REC128620-42201	IMPULSOR	IMPELLER	GIRANTE	TURBINE
	REC123682-48601	TERMOSTATO	THERMOSTAT	TERMOSTATO	THERMOSTAT
	REC25132-004250E	CORREA ALTERNADOR	ALTERNATOR BELT	CINGHIA ALTERNATORE	COUROIE ALTERNATEUR
6GHA-ET	REC128633-35400	FILTRO ACEITE	OIL FILTER	FILTRO OLIO	FILTRE D'HUILE
	REC41650-501140	FILTRO COMBUSTIBLE	FUEL FILTER	FILTRO COMBUSTIBILE	FILTRE CARBURANT
	REC128628-42200	IMPULSOR	IMPELLER	GIRANTE	TURBINE
	REC145640-48410	TERMOSTATO	THERMOSTAT	TERMOSTATO	THERMOSTAT
	REC128610-77350	CORREA ALTERNADOR	ALTERNATOR BELT	CINGHIA ALTERNATORE	COUROIE ALTERNATEUR
	TEN01303	ÁNODO	ANODE	ANODO	ANODE
	TEN01301	ÁNODO	ANODE	ANODO	ANODE
	TEN01311	ÁNODO	ANODE	ANODO	ANODE
TEN01312	ÁNODO	ANODE	ANODO	ANODE	
6GHA-ST, STE 6GHAK-ST1 6GHAM-STE 6GHD-ST	REC126650-35220	FILTRO ACEITE	OIL FILTER	FILTRO OLIO	FILTRE D'HUILE
	REC41650-501140	FILTRO COMBUSTIBLE	FUEL FILTER	FILTRO COMBUSTIBILE	FILTRE CARBURANT
	REC128628-42200	IMPULSOR	IMPELLER	GIRANTE	TURBINE
	REC145640-48410	TERMOSTATO	THERMOSTAT	TERMOSTATO	THERMOSTAT
	REC128610-77350	CORREA ALTERNADOR	ALTERNATOR BELT	CINGHIA ALTERNATORE	COUROIE ALTERNATEUR
	TEN01303	ÁNODO	ANODE	ANODO	ANODE
	TEN01301	ÁNODO	ANODE	ANODO	ANODE
	TEN01311	ÁNODO	ANODE	ANODO	ANODE
TEN01312	ÁNODO	ANODE	ANODO	ANODE	
6KHL-ST	REC124626-35420	FILTRO ACEITE	OIL FILTER	FILTRO OLIO	FILTRE D'HUILE
	REC41650-502330	FILTRO COMBUSTIBLE	FUEL FILTER	FILTRO COMBUSTIBILE	FILTRE CARBURANT
	REC126630-42030	IMPULSOR	IMPELLER	GIRANTE	TURBINE
	REC145640-48410	TERMOSTATO	THERMOSTAT	TERMOSTATO	THERMOSTAT
	REC126634-11340	CORREA ALTERNADOR	ALTERNATOR BELT	CINGHIA ALTERNATORE	COUROIE ALTERNATEUR
	TEN01303	ÁNODO	ANODE	ANODO	ANODE
	TEN01301	ÁNODO	ANODE	ANODO	ANODE
	TEN01311	ÁNODO	ANODE	ANODO	ANODE
6LPA-DTP, -DTZP, -STP, -STZ 6LP-DT, -DTE, -DTZE, -DTZY, -ST, -STE, -STZE, -STZY, -WDT, -WDTZY	REC119770-90620	FILTRO ACEITE	OIL FILTER	FILTRO OLIO	FILTRE D'HUILE
	REC119773-55510	FILTRO COMBUSTIBLE	FUEL FILTER	FILTRO COMBUSTIBILE	FILTRE CARBURANT
	REC119593-18880	FILTRO AIRE	AIR FILTER	FILTRO ARIA	FILTRE D'AIRE
	REC13554-0001	IMPULSOR	IMPELLER	GIRANTE	TURBINE
	REC119773-49550	TERMOSTATO	THERMOSTAT	TERMOSTATO	THERMOSTAT
	REC119775-77260	CORREA ALTERNADOR	ALTERNATOR BELT	CINGHIA ALTERNATORE	COUROIE ALTERNATEUR
	TEN01317T	ÁNODO	ANODE	ANODO	ANODE
6LY2-ST	REC119593-35100	FILTRO ACEITE	OIL FILTER	FILTRO OLIO	FILTRE D'HUILE
	REC119593-35400	FILTRO COMBUSTIBLE	FUEL FILTER	FILTRO COMBUSTIBILE	FILTRE CARBURANT
	REC127695-55630	FILTRO COMBUSTIBLE	FUEL FILTER	FILTRO COMBUSTIBILE	FILTRE CARBURANT
	REC119195-18880	FILTRO AIRE	AIR FILTER	FILTRO ARIA	FILTRE D'AIRE
	CEF500162G	IMPULSOR	IMPELLER	GIRANTE	TURBINE
	REC127605-48590	TERMOSTATO	THERMOSTAT	TERMOSTATO	THERMOSTAT
	REC119593-42350	CORREA ALTERNADOR	ALTERNATOR BELT	CINGHIA ALTERNATORE	COUROIE ALTERNATEUR
	TEN01317T	ÁNODO	ANODE	ANODO	ANODE



## REF

6LY2-STE	REC119593-35100	FILTRO ACEITE	OIL FILTER	FILTRO OLIO	FILTRE D'HUILE	
	REC119593-35400	FILTRO COMBUSTIBLE	FUEL FILTER	FILTRO COMBUSTIBILE	FILTRE CARBURANT	
	REC127695-55630	FILTRO COMBUSTIBLE	FUEL FILTER	FILTRO COMBUSTIBILE	FILTRE CARBURANT	
	REC119195-18880	FILTRO AIRE	AIR FILTER	FILTRO ARIA	FILTRE D'AIRE	
	CEF500162G	IMPULSOR	IMPELLER	GIRANTE	TURBINE	
	REC127605-48590	TERMOSTATO	THERMOSTAT	TERMOSTATO	THERMOSTAT	
6LY2-STVY	REC119593-35100	FILTRO ACEITE	OIL FILTER	FILTRO OLIO	FILTRE D'HUILE	
	REC119593-35400	FILTRO COMBUSTIBLE	FUEL FILTER	FILTRO COMBUSTIBILE	FILTRE CARBURANT	
	REC127695-55630	FILTRO COMBUSTIBLE	FUEL FILTER	FILTRO COMBUSTIBILE	FILTRE CARBURANT	
	REC127605-48590	TERMOSTATO	THERMOSTAT	TERMOSTATO	THERMOSTAT	
	TEN01317T	ÁNODO	ANODE	ANODO	ANODE	
	6LY2-STP	REC119593-35100	FILTRO ACEITE	OIL FILTER	FILTRO OLIO	FILTRE D'HUILE
REC119593-35400		FILTRO COMBUSTIBLE	FUEL FILTER	FILTRO COMBUSTIBILE	FILTRE CARBURANT	
REC47-809866T		IMPULSOR	IMPELLER	GIRANTE	TURBINE	
TEN01317T		ÁNODO	ANODE	ANODO	ANODE	
6LY2-STVY 6LY2A-STE, -UTP 6LY2M-WDT, -WST		REC119593-35100	FILTRO ACEITE	OIL FILTER	FILTRO OLIO	FILTRE D'HUILE
		REC119593-35400	FILTRO COMBUSTIBLE	FUEL FILTER	FILTRO COMBUSTIBILE	FILTRE CARBURANT
	REC127695-55630	FILTRO COMBUSTIBLE	FUEL FILTER	FILTRO COMBUSTIBILE	FILTRE CARBURANT	
	TEN01317T	ÁNODO	ANODE	ANODO	ANODE	
	6LY2-WDT, -WDTZY, -WST	REC119593-35100	FILTRO ACEITE	OIL FILTER	FILTRO OLIO	FILTRE D'HUILE
		REC119593-35400	FILTRO COMBUSTIBLE	FUEL FILTER	FILTRO COMBUSTIBILE	FILTRE CARBURANT
REC127695-55630		FILTRO COMBUSTIBLE	FUEL FILTER	FILTRO COMBUSTIBILE	FILTRE CARBURANT	
TEN01317T		ÁNODO	ANODE	ANODO	ANODE	
6LY2A-STP		REC119593-35100	FILTRO ACEITE	OIL FILTER	FILTRO OLIO	FILTRE D'HUILE
		REC119593-35400	FILTRO COMBUSTIBLE	FUEL FILTER	FILTRO COMBUSTIBILE	FILTRE CARBURANT
	REC127695-55630	FILTRO COMBUSTIBLE	FUEL FILTER	FILTRO COMBUSTIBILE	FILTRE CARBURANT	
	REC119195-18880	FILTRO AIRE	AIR FILTER	FILTRO ARIA	FILTRE D'AIRE	
	REC119574-42550	IMPULSOR	IMPELLER	GIRANTE	TURBINE	
	REC127605-48590	TERMOSTATO	THERMOSTAT	TERMOSTATO	THERMOSTAT	
6LY3-ETP, -STP, -UTP	REC119593-35100	FILTRO ACEITE	OIL FILTER	FILTRO OLIO	FILTRE D'HUILE	
	REC41650-502330	FILTRO COMBUSTIBLE	FUEL FILTER	FILTRO COMBUSTIBILE	FILTRE CARBURANT	
	REC119195-18880	FILTRO AIRE	AIR FILTER	FILTRO ARIA	FILTRE D'AIRE	
	REC119574-42550	IMPULSOR	IMPELLER	GIRANTE	TURBINE	
	REC119593-42350	CORREA ALTERNADOR	ALTERNATOR BELT	CINGHIA ALTERNATORE	COUROIE ALTERNATEUR	
	CMC272100-20030	ÁNODO	ANODE	ANODO	ANODE	
6LYA-STE	REC119593-35100	FILTRO ACEITE	OIL FILTER	FILTRO OLIO	FILTRE D'HUILE	
	REC41650-502330	FILTRO COMBUSTIBLE	FUEL FILTER	FILTRO COMBUSTIBILE	FILTRE CARBURANT	
	REC119195-18880	FILTRO AIRE	AIR FILTER	FILTRO ARIA	FILTRE D'AIRE	
	REC119574-42550	IMPULSOR	IMPELLER	GIRANTE	TURBINE	
	TEN01316	ÁNODO	ANODE	ANODO	ANODE	

# SISTEMA DE ALIMENTACIÓN Y FILTRACIÓN FUEL & FILTRATION SYSTEM

## SISTEMA DI ALIMENTAZIONE E FILTRAZIONE SYSTÈME D'ALIMENTATION ET DE FILTRATION

FILTRO  
DE COMBUSTIBLE  
Y ELEMENTOS

FUEL FILTERS  
AND ELEMENTS

FILTRI BENZINA  
E RACCORDI

FILTRE A ESSENCE  
ET CARTOUCHE DE  
RECHANGE

FILTRO GASOLINA

FUEL FILTER

FILTRO BENZINA

FILTRE À ESSENCE

REF	OEM	
REC119773-55510	119773-55510	6LPA-DTP, -DTZP, -STP, -STZ 6LP-DT, -DTE, -DTZE, -DTZY, -ST, -STE, -STZE, -STZY, -WDT, -WDTZY



REF	OEM	
REC129574-55711	129574-55711	4JH2-UTE 4JH3-DTE, -HTE, -TE



REF	OEM	
REC127695-55630	127695-55630	6LY2M-WST, -WDT 6LY-ST, -STZY, -UT, -UTE, -UTM, -UTZY, -WST, -WSTZY, -WUT, -WUTZY 6CX-ETE, -GT 6CXM-ETE



REF	OEM	
REC121857-55710	121857-55710	4LH-HTE, -TE



REF	OEM	
REC129470-55703	129470-55703	3JH25A 3JH2E, L, -TCE 3JH3E-YEU-E 3JHAE 4JH2-DTE, E, -HTE, -TE 4JH4E, AE 4JH5E 4JH-DTE, E, -HTE, -HTZ, -HTZAE 6JH2





REF	OEM	
REC119802-55810	119802-55810	3JH5AE, E







REF	OEM	
REC41650-501140	41650-501140	6GHA-ET, -ST, -STE 6GHAK-ST1 6GHAM-STE 6GHD-ST





REF	OEM	
REC41650-502320	41650-502320	4JH-TZ 4LHA-DTE, -DTP, -DTZE, -DTZP, -HTE, -HTP, -HTZE, -HTZP, -STE, -STP, -STZE, -STZP 4LH-DTE, -DTZ, -HT, -HTZ, -HTZAY, -ST, -STE, -STZ, -STZAY, -UT, -UTZ, -UTZAY



REF	OEM	
REC41650-502330	41650-502330	6LY2A-STE, -STP, -UTP 6LY3-ETP, -STP, -UTP 6LYA-STE, -STP, -UTE 6LYM-UTE, -STE, -UTEHD 6LY-STE, -STM





REF	OEM	
REC104500-55710	104500-55710	1GM, L, Y-C 1GM10 2GM20, F, F-YEU, -YEU 2GMLP 3GM30, F, F-YEU 3HM, F 3HM35 3YM20 3YM27A 3YM30, A



*new*



REF	OEM	
REC120650-55040	120650-55040	4BY 6BY



REF	OEM	
REC120324-55760	120324-55760	6LY2M-WST, -WDT 6LY-ST, -STZY, -UT, -UTE, -UTM, -UTZY, -WST, -WSTZY, -WUT, -WUTZY, -STM



*new*

REF	OEM		
REC121370-55601	121370-55601 124790-55601	3YM, 30, 20, 15, 27A, 30R, 30AE 2QM, 15, 20 2YM15 3QM, 30 1GM, 2GM, 3GM	REC104500-55710





FILTRO CON CAZOLETA

BOWL FILTERS

FILTRO CON COPPA

FILTRE AVEC COUPE



**RACOR**

	RAC500MA30	RAC900VMA	RAC900MA30	RAC1000VMA	RAC1000MA30	RAC75/500MAX	RAC75/1000MA30
	227 l/h 60 gph	340 l/h 90 gph	341 l/h 90 gph	681 l/h 180 gph	681 l/h 180 gph	454 l/h 120 gph	681 / 1363 l/h 180 / 360 gph
	2010	2010	2040	2010	2020	2010	2020
A X B X C	292 x 147 x 122 mm	432 x 220 x 200 mm	432 x 152 x 178 mm	557 x 220 x 200 mm	559 x 152 x 178 mm	292 x 368 x 241 mm	559 x 476 x 279 mm
	3/4"-16 UNF	7/8"-14 UNF	7/8"-14 UNF	7/8"-14 UNF	7/8"-14 UNF	3/4"-16 UNF	7/8"-14 UNF
	2 kg	4,9 kg	3 kg	5,6 kg	5 kg	7,7 kg	13,6 kg
CAIDA DE PRESIÓN PRESSURE DROP CADUTA DI PRESSIONE CHUTE DE PRESSION	0.61 PSI 0.04 bar	0.30 PSI 0.021 bar	0.34 PSI 0.02 bar	0.43 PSI 0.03 bar	0.49 PSI 0.03 bar	0.70 PSI 0.05 bar	3.70 PSI 0.25 bar
MAX	15 PSI 1 bar	15 PSI 1 bar	15 PSI 1 bar	15 PSI 1 bar	15 PSI 1 bar	15 PSI 1 bar	15 PSI 1 bar
MÀX.	102 mm	127 mm	127 mm	254 mm	254 mm	102 mm	254 mm

ELEMENTOS DE RECAMBIO

ELEMENT

ELEMENTI DI RICAMBIO

CARTOUCHE DE RECHANGE

REF 500	REF 900	REF 1000	MICRON
RAC2010SM-OR	RAC2040SM-OR	RAC2020SM-OR	2
RAC2010TM-OR	RAC2040TM-OR	RAC2020TM-OR	10
RAC2010PM-OR	RAC2040PM-OR	RAC2020PM-OR	30

**RACOR**



S: SECUNDARIO  
T: PRIMARIO O SECUNDARIO/FINAL  
P: PRIMARIO

S: SECONDARY FINAL  
T: PRIMARY OR SECONDARY FINAL  
P: PRIMARY

S: SECONDARIO  
T: PRIMARIO O SECONDARIO  
P: PRIMARIO

S: SECONDAIRE  
T: PRIMAIRE OU SECONDAIRE  
P: PRIMAIRE

REF	OEM		MICRON
REC3581760	3581760	R500MA	30
REC889419	889419	R900MA	
REC889422	889422	R1000MA	

**RECMAR**



REC3581760

REC889419

REC889422

new



**FILTRO DECANTADOR DIESEL**

**COMPLETE DIESEL FILTER**

**FILTRO DECANTATORE DIESEL**

**FILTRE DECANTEUR DIESEL**

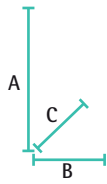

**RACOR**

	RAC120AS	RAC230R2	RAC245R2	RAC460R2	RAC490R2
	57 l/h 15 gph	114 l/h 30 gph	170 l/h 45 gph	227 l/h 60 gph	341 l/h 90 gph
	RACR12	RACR20	RACR25	RACR60	RACR90
	✓	✓	✓	✓	✓
	✓				
CAZOLETA TRANSPARENTE CLEAR BOWL VASCHETTA TRASPARENTE BOL TRASPARENT	✓	✓	✓	✓	✓
INSTALACIÓN VACUÓMETRO VACUUM INSTALLATION INSTALLAZIONE VACUOMETRO INSTALLATION VACUOMETRE	✓	✓	✓	✓	✓
INSTALACIÓN PRESIÓN PRESSURE INSTALLATION INSTALLAZIONE PRESSIONE INSTALLATION PRESSION	✓	✓	✓	✓	✓
A X B X C (mm)	165 x 81 x 81	229 x 102 x 102	267 x 102 x 102	279 x 114 x 121	300 x 114 x 121
	0,59 kg	0,90 kg	1 kg	1,3 kg	1,4 kg
CAIDA DE PRESIÓN PRESSURE DROP CADUTA DI PRESSIONE CHUTE DE PRESSION	0.15 PSI 0.01 bar	0.31 PSI 0.02 bar	0.61 PSI 0.04 bar	0.39 PSI 0.03 bar	0.95 PSI 0.06 bar
	7 PSI	30 PSI	30 PSI	30 PSI	30 PSI
	1/4" NPT	1/4" NPT	1/4" NPT	3/8" NPT	3/8" NPT
BOMBA CEBADO (SÓLO PARA DIESEL) PRIMER PUMP (ONLY DIESEL) POMPA (SOLO PER DIESEL) POMPE (SEULEMENT POUR DIESEL)	✗	✓	✓	✓	✓
Nº TOMAS NUM. OF PORTS Nº FORI Nº D'ENTREE / SORTIE	4	3	3	4	4
OPCIÓN SENSOR AGUA WATER SENSOR OPTION OPZIONE SENSORE ACQUA OPTION SONDE DE PRESENCE D'EAU	✓	✓	✓	✓	✓

**ELEMENTOS DE RECAMBIO**

**ELEMENT**

**ELEMENTI DI RICAMBIO**

**CARTOUCHE DE RECHANGE**

REF	MICRON		REF	MICRON		REF	MICRON	
RACR11T	10		RACR24S	2		RACR60S	2	
			RACR24T	10		RACR60T	10	
			RACR24P	30		RACR60P	30	
REF	MICRON		REF	MICRON		REF	MICRON	
RACR12S	2		RACR25S	2		RACR90S	2	
RACR12T	10		RACR25T	10		RACR90T	10	
RACR12P	30		RACR25P	30		RACR90P	30	
REF	MICRON		REF	MICRON		REF	MICRON	
RACR20S	2		RACR26S	2		RACR120SM	2	
RACR20T	10		RACR26T	10		RACR120TM	10	
RACR20P	30		RACR26P	30		RACR120P	30	

FILTRO DECANTADOR DIESEL

COMPLETE DIESEL FILTER

FILTRO DECANTATORE DIESEL

FILTRE DECANTEUR DIESEL

**RECmar®** new

REF	MICROM	2 x	2 x	
REC1766160	10	205-420 L/H (2.45PSI)	11/16" 10 mm	REC160ELEMENT

**RECmar®** new

REF	OEM			
REC500MA	22677639 35-850481 35-850481A1	RAC913-08-H6 (13 mm) RAC913-08-H8 (10 mm)	227 l/h	REC3581760 RAC2010TM-OR

**RECmar®** new

REF		
REC296TWIN	50 L/H	REC3581078

**RECmar®** new

REF			CUBETA BOWL VASCHETTA SEAU	
REC2656613	50 l/h	G30432 (8mm) GS30433 (10 mm)	METAL.	REC3581078

**RECmar®** new

REF		2 x	2 x	
RECSWK-2000/10	600 L/H	M22X1.5		RECGS01030
RECSWK-2000/5	300 L/H	M162X1.5		RECGS00530



FILTRO DE ACEITE

OIL FILTER

FILTRO OLIO

FILTRE A HUILE

REF	OEM	
REC126650-35350	126650-35350	6GHA-ST, -STE 6GHAK-ST1 6GHAM-STE 6GHD-ST



REF	OEM	
REC119770-90620	119770-90620	6LPA-DTP, -STZ, -STP 6LPS-DTZP 6LP-DT, -DTE, -DTZE, -DTZY, -ST, -STE, -STZE, -STZY, -WDT, -WDTZY



REF	OEM	
REC119305-35151	119305-35151	1GM, Y-C 1GM10 2GM20, F, F-YEU, -YEU 2GM1P, SZK 3GM30, F, F-YEU 3JH2, E, L, -YCE 3JH3-YEU-E 3JH4E 3JH5, AE 3YM20 3YM30



REF	OEM	
REC119005-35100	119005-35100 119005-35151 109005-35170	4LH-HTE, -TE



REF	OEM	
REC119593-35100	119593-35100	6LY3-ETP, -STP, -UTP 6LYA-STE, -STP, -UTE 6LYM-UTE, -STE, -UTEHD 6LY2-ST, -STE, -STVY, -STP, -WDT, -WDTZY, -WST 6LY2A-STE, -STP, -UTP 6LY2M-WDT, -WST 6LY-ST, -STE, -STM, -STZY, -UT, -UTE, -UTM, -UTZY, -WST, -WSTZY, -WUT, -WUTZY



REF	OEM	
REC119593-35400	119593-35400	6LY2-ST, -STE, -STVY, -STP, -WDT, -WDTZY, -WST 6LY2A-STE, -STP, -UTP 6LY2M-WDT, -WST 6LY-ST, -STE, -STM, -STZY, -UT, -UTE, -UTM, -UTZY, -WST, -WSTZY, -WUT, -WUTZY



REF	OEM	
REC127695-35150	127695-35150 127695-35160	4LHA-DTE, -DTP, -DTZE, -DTZP, -HTE, -HTP, -HTZE, -HTZP, -STE, -STP, -STZE, -STZP 4LH-DTE, -DTZ, -HT, -HTZ, -HTZAY, -ST, -STE, -STZ, -STZAY, -UT, -UTZ, -UTZAY, -WST, -WSTZY 6CX-ETE, -GT 6CXM-ETE



REF	OEM	
REC124550-35110	124550-35110 124085-35113	3HM, F 3HM35



YANMAR

RECAMBIOS MARINOS

REF	OEM	
REC129150-35153	129150-35153 129150-35170	2JH2-DTE 3JH25A 4JH, -DTE, E, -HTE, -HTZ, -HTZAE, -TE, -TZ 4JH2E, -HTE, -TE, -UTE 4JH3-HTE, -TE 4JH4E, AE 4JH5E



REF	OEM	
REC128633-35400	128633-35400	6GHA-ET



**JUNTAS BOMBA ACEITE OIL PUMP GASKETS GUARNIZIONE POMPE OLIO JOINT POMPE D'UILE**

REF	OEM	
REC128170-32030	128170-32030	1GM, L, Y-C 1GM10



REF	OEM	
REC129120-35121	129120-35121	3JH3, E, E-YEU-E



REF	OEM	
REC121450-32021	121450-32021	2GM20, F 2GM 2GM50F-YEU 3GM30, F, F-YEU 3GM



REF	OEM	
REC129470-35040	129470-35040	3JH2, -TCE, E, L 3JH3, E-YEU-E 4LH-TE, -HTE, -DTE, -STE, -HT, -HTZ, -HTZAY, -DTZ, -UT, -UTZAY, -UT2, -ST, -STZAY, -STZ, -WST, -WSTZY 4LHA-STE, -STP 4LHS-STZE, -STZP, -DTE, -DTP, -DTZE, -DTZP, -HTE, -HTP, -HTZE, -HTZP



REF	OEM	
REC119000-32020	119000-32020	4LH-TE, -HTE, -DTE, -STE, -HT, -HTZ, -HTZAY, -DTZ, -UT, -UTZAY, -UT2, -ST, -STZAY, -STZ, -WST, -WSTZY 4LHA-STE, -STP 4LHS-STZE, -STZP, -DTE, -DTP, -DTZE, -DTZP, -HTE, -HTP, -HTZE, -HTZP



REF	OEM	
REC129150-35042	129150-35042	3JH25A 3JH40 3JH4E 4JH



**JUNTA SOPORTE FILTRO DE ACEITE OIL FILTER SUPPORT GASKET GUARNIZIONE SUPPORTO FILTRO OLIO JOINT SUPPORT FILTRE D'UILE**

REF	OEM	
REC129470-35121	129470-35121	3JH2, -TCE, E, L 3JH3, E-YEU-E 4LH-TE, -HTE, -DTE, -STE, -HT, -HTZ, -HTZAY, -DTZ, -UT, -UTZAY, -UT2, -ST, -STZAY, -STZ, -WST, -WSTZY 4LHA-STE, -STP 4LHS-STZE, -STZP, -DTE, -DTP, -DTZE, -DTZP, -HTE, -HTP, -HTZE, -HTZP





## FILTRO DE AIRE

## AIR FILTER

## FILTRO ARIA

## FILTRE AIRE

REF	OEM	
REC128170-12540	128170-12540	1GM 1GML



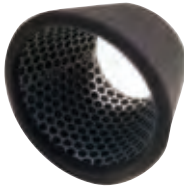

REF	OEM	
REC124770-12540	124770-12540	3HM, F 3HM35



REF	OEM	
REC128270-12540	128270-12540	2GM, LP, SZK 2GM20F, F-YEU, -YEU 3GM30, F, F-YEU 3YM20 3YM30, AE





REF	OEM	
REC129470-12330	129470-12330	3JH2-TCE 4JH2-DTE, E, -TE, -UTE 4JH3-DTE, -HTE, -TE 4JHE, -TE, -TZ





REF	OEM	
REC119195-18880	119195-18880	4LHA-DTE, -DTP, -DTZE, -DTZP, -HTE, -HTP, -HTZE, -HTZP, -STE, -STP, -STZE, -STZP 6LY2-ST, -STE



REF	OEM	
RECXN199611	XN199611	4LH-DTE, -DTZ, -HT, -HTE, -HTZ, -HTZAY, -STE, -TE



REF	OEM	
REC119593-18880	119593-18880	6CX-ETE 6LPA-DTP, -DTZP, -STP, -STZ 6LP-DT, -DTE, -DTZE, -DTZY, -ST, -STE, -STZE, -STZY, -WDT, -WDTZY 6LY2-STVY, -WDT, -WDTZY, -WST, A-STE, A-STP, A-UTP 6LY2M-WDT, -WST 6LY3-ETP, -STP, -UTP 6LYA-STE, -STP, -UTE 6LYM-UTE, -STE, -UTEHD 6LY-ST, -STE, -STM, -STZY, -UT, -UTE, -UTM, -UTZY, -WST, -WSTZY, -WUT, -WUTZY



REF	OEM	
REC127692-18880	127692-18880	6CX-GT 6CXM-ETE



## MANGUERA CARBURANTE

## FUEL HOSE

## TUBO DI CARBURANTE

## TUYAU DU CARBURANT







Tubo de goma para el transporte de carburante (diesel o gasolina). Construida en goma negra (NBR). Contenido aromático no superior al 60%. Resistente a la abrasión de los agentes marinos.

Long length rubber hose, suitable for loading diesel, bio-diesel and unloaded fuel for marine pleasure craft inboard engines up to 24 m.

Tubo in gomma per il passaggio di carburante (diesel o benzina). In gomma nera (NBR). Per motori entro bordo su imbarcazioni da diporto fino a 24m.

Tuyau en caoutchouc pour le passage du carburant (diesel ou essence). Caoutchouc noir (NBR). Pour moteurs in-bord sur bateaux de plaisance jusqu'à 24m.

### CARBO/7840/A1

REF	Ø (mm)						
GS35049	6x16	14 bar	35 mm			40 m	
GS35050	8x17	14 bar	50 mm			40 m	
GS35051	10x19	14 bar	60 mm			40 m	
GS35052	12x22	10 bar	75 mm	-30°C ~ 100°C	30 bars	20 m	Rina CE 0474 Lloyd's Register 96/00/127
GS35053	16x26	10 bar	100 mm			40 m	
GS35054	19x30	10 bar	115 mm			20 m	
GS35055	25x37	10 bar	250 mm			x m	



SAE J 1527 - 2004

USCG A1 R1

ISO 7840 A-1 2004 CE



De goma para diesel y gasolina sin plomo. Ideal para fueraborda. Refuerzos textiles internos. Muy flexible. Contenido aromático 50%.

Rubber Hose suitable for loading mineral oils, diesel and unleaded fuel

In gomma per diesel e benzina senza piombo. Ideale per motori fuoribordo. Tessuto interno rinforzato. Molto flessibile.

En caoutchouc pour diesel et essence sans plomb. Idéal pour les moteurs hors-bord. Tissu intérieur renforcé. Très flexible.

**CARBUPOMP/10NL**

REF	Ø (mm)				
GS35031	6x12	10 bar	50 mm	-25°C ~80° C	50 m
GS35032	8x15	10 bar	65 mm		50 m

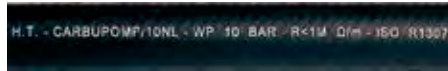

ISO R1307

Manguera para líneas de combustible. Con refuerzo termoplástico que le permite excelente flexibilidad y resistencia a los rayos UV. Color gris. Resistente al alcohol. Especialmente indicado para motores fueraborda.

Marine fuel hose for outboards. Fuel resistant thermo-plastic formulation with 2 spiral reinforcement provides excellent bendability and resistance to UV, aging and permeation by all marine fuels (gasoline/petrol and diesel) including alcohol blends.

Tubi per il condotto del carburante. Con rinforzo termoplastico che gli permette un'eccellente flessibilità e resistenza ai raggi UV. Resistente alle miscele di alcool. Indicato per motori fuoribordo.

Tuyau de carburant marin. La formulation thermoplastique avec 2 renforts en spirale offre une excellente flexibilité et résistance aux UV, au vieillissement et à la perméation de tous les carburants marins (essence et diesel), y compris les mélanges d'alcool.

REF	Ø		
TRI305-0566	8 mm 5/16"	15 m	1
TRI305-0386	10 mm 3/8"	15 m	1

SAE J 1527  
ISO-8469 B1



**RACORS**

**RACORS**

**RACCORDI**

**RACCORDS**

REF		
GS30430	8 mm	2
GS30431	10 mm	2



ORIENTABLES  
GUIDIBLE  
ORIENTABILE  
ORIENTABLE

REF		
GS30432	8 mm	2
GS30433	10 mm	2



REF				
RAC1/2X16	1/2"	16 mm		1
RAC1/2X18	1/2"	18 mm	500	1
RAC1/2X20	1/2"	20 mm	900	1
RAC3/8X10	3/8"	10 mm	1000	1
RAC3/8X12	3/8"	12 mm		1
RAC3/8X14	3/8"	14 mm		1



REF	NPT		
BRA125-3/16x1/4	1/4"	3/16"	1
BRA125-1/4x1/2	1/2"	1/4"	1
BRA125-5/16x3/8	3/8"	5/16"	1
BRA125-3/8x3/8	3/8"	3/8"	1
BRA125-3/8x1/2	1/2"	3/8"	1
BRA125-1/2x3/8	3/8"	1/2"	1
BRA125-1/2x1/2	1/2"	1/2"	1
BRA125-1/2x3/4	3/4"	1/2"	1
BRA125-5/8x3/8	3/8"	5/8"	1
BRA125-5/8x3/4	3/4"	5/8"	1
BRA125-3/4x3/4	3/4"	3/4"	1
BRA125-1x3/4	3/4"	1"	1
BRA125-1/4X3/8	1/4"	3/8"	1



REF	NPT	NPT		
RAC1/2F-1/2M	7/8"	1/2"	900	1
RAC3/8F-3/8M	3/4"	3/8"	500	1



REF			
GS31066	1/4" NPT	5/16" = 7.9 mm	2
GS31055	3/8" NPT	3/8" = 9.5 mm	2
GS31056	3/8" NPT	5/16" = 7.9 mm	2





ACCESORIOS PARA  
FILTROS

FILTER ACCESSORIES

ACCESSORI PER FILTRI

ACCESSOIRES POUR  
FILTRES

LLAVES PARA FILTRO

FILTER KEY

CHIAVE DA FILTRO

CLÉ À FILTRE

REF  
RACRK22628  
**RACOR.**



REF  
REC70720 65 - 110 mm  
**RECMAR®**

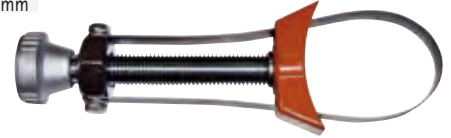

VÁLVULA DRENAJE AGUA  
DE FILTROS RACOR

DRAIN VALVE FOR RACOR  
FILTERS

VALVOLA DRENAGGIO  
ACQUA PER FILTRI RACOR

VANNE DE DRAINAGE  
D'EAU POUR FILTRE RACOR

REF  
RACRK19492UL  
**RACOR.**



REF  
REC500MACON 500 3/8" = 10 mm



new

SENSOR DE AGUA PARA  
FILTROS DIESEL

WATER SENSOR FOR  
DIESEL FILTERS

SENSORE ACQUA PER  
FILTRI DIESEL

SONDE DE PRESENCE  
D'EAU POUR DIESEL

REF  
RECRK21069  
**RECMAR®**



RELOJ SENSOR DE AGUA

WATER ALARM

ALLARME SENSORE  
ACQUA

ALARME SENSOR  
D'EAU

REF  
RACRK20726  
**RACOR.**



BOMBA COMBUSTIBLE  
MECÁNICA

MECHANICAL  
FUEL PUMP

POMPA COMBUSTIBILE  
MECCANICA

POMPE CARBURANT  
MÉCANIQUE

REF  
REC129158-52101 129158-52101



3JH  
4JH  
3YM



new

REF  
REC105582-52010 105582-52010



1GM  
1GM10  
2WM  
2QM20  
3QM  
3QM30  
SB  
SBF (12)



new

TURBO

TURBO

TURBINE

TURBO

TUBO

TURBO

TURBINE

TURBO



TURBO

REF

OEM



4LH-HTE  
4LH-TE

MY58

REC119171-18010

119171-18010

REC128300-13230



4LH-DTE

53269886292

REC119173-18011

119173-18011



4JH3-T

MYCZ

REC129671-18001

129671-18001

REC129472-18090



4LH-STE

MYAV

REC119195-18031

119195-18031

REC128300-13230

4LHA-DTZE  
4LHA-DTE  
4LHA-DTP



MYDH

REC119173-18041

119173-18041

REC128300-13230



	TURBO	REF	OEM	
4LH-HTE	MYBF	REC119172-18011	119172-18011	REC128300-13230
4JH-TE	MY29	REC129497-18000	129497-18000	REC129472-18090
4JH-DTE	MY34	REC129473-18000	129473-18000	REC129472-18090
4LHA-STP 4LHA-STE	MYDA	REC119175-18031	119175-18031	REC128300-13230
4LHA-HTE	MYDN	REC119172-18030	119172-18030	REC128300-13230



	TURBO	REF	OEM		
4JH-HTE, DTE 4JH2-HTE	MYBD, MYBDE	REC129474-18001	129474-18001	REC129472-18090	
4JH3-DTE, DT, DTZ, DTZAY, DTZA, HTE	MYBG, MYBGE	REC129693-18001	129693-18001 129693-18000	REC129472-18090	
6LP-DTE, DTZE, WDTZY, WST, WSTZY, WDT, DT 6LPA-DTEP, DTZEP, DTZEP1	MYAX	REC119773-18010	119773-18010	REC128300-13230	
6LP-STE, STZE, STZY, STZE1, STZYJ 6LPA-STE, STZE, STZEP1	MYBHE	REC119775-18010	119775-18010	REC128300-13230	
6LY3-STC, ETP, UTC, UTP, STP 6LY400 CN/ 6LY440CN	MYEM	REC119578-18010	119578-18010		
6LYA-STE(P), STP	MYDW	REC119574-18020	119574-18020		

new



# SISTEMA ELÉCTRICO ELECTRIC SYSTEM

# SISTEMA ELETTRICO SYSTÈME ÉLECTRIQUE

SENSORES	SENSORS	SENSORE	CAPTEURS
----------	---------	---------	----------

SENSOR PRESIÓN DE ACEITE	OIL PRESSURE SENDER	SENSORE PRESIONE OLIO	SONDE PRESSION D'HUILE
--------------------------	---------------------	-----------------------	------------------------

REF	OEM	
REC124060-39452	124060-39452 124060-3945	1GM / 2GM / 3GM Serie 3HM / 3HMF 4JH / 4LH Series





new

SENSOR TEMPERATURA AGUA	WATER TEMPERATURE SENDER	SENSORE TEMPERATURA ACQUA	SONDE TEMPERATURE DE L'EAU
-------------------------	--------------------------	---------------------------	----------------------------

REF	OEM	
REC127610-91350	127610-91350	2GM20F 2GMF-YEU 3GM30F, F-YEU, 3HMF 3JH25A 3JH2, E, L, -TCE 3JH3 4CH-DT 4JH, -TZ 4JH2E, -DTE, -HTE, -TE, -UTE 4JHA-DTE 4LHA-DTP, -DTZE, -DTZP, -HTE, -HTP, -HTZE, -HTZP, -STE, -STP, -STZE, -STZP 4LH-DTE, -DTZ, -HT, -HTE, -HTZ, -HTZAY, -ST, -STE, -STZ, -STZAY, -TE 6CX-ETE, M-ETE, 6GHA-ET, -ST, -STE 6GHAK-ST1, 6GHAM-STE 6GHD-ST 6KHL-ST 6LPA-DTP, -STP, -STZ 6LP-DT, -DTE, -DTZE, -DTZY, -ST, -STE, -STZE, -STZY, WDT, -WDTZY 6LY2-ST, -WDT, -WDTZY, -WST 6LY2A-STE, -STP, -UTP 6LY2M-WDT, -WST 6LYA-STE, -STP, -UTE 6LYM-UTE, -STE 6LY-ST, -STE, -STM, -STZY, -UT, -UTE, -UTM, -UTZY, -WST, -WSTZY, -WUT, -WUTZY



REF	OEM	
REC128275-91340	128275-91340	1GM, L, Y-C 1GM10 2GM20, -YEU 2GM, LP, SZK 3GM30 3HM 3HM35



REF	OEM	
REC120130-91370	120130-91370	3JH4E 3JH5AE, E 4JH3-DTE, -HTE, -TE 4JH4AE 4JH5E 4JHE 4JH-HTE, -HTZ, -HTZAE, -TE



YANMAR

RECAMBIOS  
MARINOS

## MOTORES DE ARRANQUE

## STARTERS

## MOTORINI AVVIAMENTO

## DÉMARREUR

REF	OEM	⚡	☀️	🔧
REC124250-77012	124250-77012	12V 1.4 kW	15 BENDIX	3HM, F
	129573-77010			3HM35
	171008-77010			3JH2, E, L, TCE
	171006-77010			3JH25A
	121256-77011			3JH3
	124450-77011			4JH, E, -HTE, -HTZ, -HTZAE, -TE, -TZ, -DTE
	124772-77010			4JH2-DTE, E, -HTE, -TE, -UTE
	124772-77020			4JH3-DTE, -HTE, -TE



REF	OEM	⚡	☀️	🔧
REC128170-77010	128170-77010	12V 1.0 kW	9 BENDIX	1GM
	128170-77010D			2GM20F, F-YEU, -YEU 3GM30, F, F-YEU



REF	OEM	⚡	☀️	🔧
REC114362-77011	114362-77011	12V 0.8 kW	8 BENDIX	L40S
	114362-77010			L60S
	114361-77011			
	114399-77010			



REF	OEM	⚡	☀️	🔧
REC129698-77010	129698-77010	12V 1.4 kW	11 BENDIX	1GM10
	129608-77010			2GM20
	129242-77010			3JH3, E-YEU-E, E
	121370-77010			3QM
				3QM30, F, H 2QM20



REF	OEM	⚡	☀️	🔧
REC119773-77010	119773-77010	12V 2.5 kW	12 BENDIX	6LPA-DTP, -DTZP, -STP, -STZ 6LP-DT, , -DTE, -DTZE, -DTZY, -ST, -STE, -STZE, -STZY, -WDT, -WDTZY



REF	OEM	⚡	☀️	🔧
REC121254-77012	121254-77010	12V 2.5 kW	15 BENDIX	4LHA-DTE, -DTP, -DTZE, -DTZP, -HTE, -HTP, -HTZE, -HTZP, -STE, -STP, -STZE, -STZP 4LH-DTE, -DTZ, -HT, -HTE, -HTZ, -HTZAY, -ST, -STE, -STZ, -STZAY, -TE, -UT, -UTZ, -UTZAY
	121254-77011			
	121254-77012			
	121254-77019			
	129429-77010			
	129429-77011			
171058-77010				



REF	OEM	⚡	☀️	🔧
REC104211-77011	104211-77011	12V 1.0 kW	9 BENDIX	SB8 SVE8 YSE8 YSM8 YSM10 YSE10 SVE12 SB12
	104211-77010			



## ALTERNADORES

## ALTERNATORS

## ALTERNATORI

## ALTERNATEURS

### ALTERNADORES

### ALTERNATORS

### ALTERNATORI

### ALTERNATEUR

REF	OEM	⚡	🌀	REG.
REC119836-77201	119836-77200	12V 40 A	SIMPLE - SERPENTÍN SIMPLE - GROOVE PULLEY SEMPLICE - SERPENTINA SIMPLE - SERPENTINE	INTERNO INTERNAL INTERNO INTERNE
	119836-77201			
	119612-77230			
	129930-77211			

Tipo Hitachi  
Type Hitachi  
Scrivi Hitachi  
Type Hitachi





REF	OEM	⚡	🔧	🌀	REG.
REC119573-77201	119573-77200 119573-77201 129470-77200 129772-77200	12V 80 A	2GM20, F, F-YEU, -YEU 3JH4E 3JH5AE, E 3YM20 4JH2-DTE, E, -HTE, -TE, -UTE 4JH3-DTE, -HTE, -TE 4JH4E, AE 4JH5E 4JH-DTE, E, -HTE 4LHA-DTE, -DTP, -DTZE, -DTZP, -HTE, -HTP, -HTZE, -HTZP, -STE, -STP, -STZE, -STZP 4LH-DTE, -DTZ, -HT, -HTE, -HTZ, -HTZAY, -ST, -STE, -STZ, -STZAY, -TE, -UT, -UTZ, -UTZAY 6LY-STE, -STM, -STZY, -UT, UTE, -UTM, -UTZY 6LYA-STE, -STP, -UTE 6LYM-UTE, -STE	SIMPLE SIMPLE SEMPLICE SIMPLE	INTERNO INTERNAL INTERNO INTERNE



REF	OEM	⚡	🔧	🌀	REG.
REC128270-77200	128270-77200 128270-77201 128270-77202 128171-77200	12V 35 A	1GM10 1GML, Y-C 2GM20 2GM1P, SZH 3HM, F 3JH2, E, L, -TCE 3JH25A 3JH3 4JH, -HTZ, -HTZAE, -TE, -TZ	SIMPLE SIMPLE SEMPLICE SIMPLE	INTERNO INTERNAL INTERNO INTERNE



REF	OEM				REG.
REC119773-77201	119773-77200 119773-77201	12V 80 A	6LPA-DTP, -DTZP, -STP, -STZ 6LP-DT, -DTE, -DTZE, -DTZY, -ST, -STE, -STZE, -STZY, -WDT, -WDTZY, -WST, -WSTZY, -DTZE1, -STZE1 6LPA-STP2, -STZP2, -STZP3, -DTZEP1, -STZEP1, -STZY	DOBLE DOUBLE DOPPIA DOUBLE	INTERNO INTERNAL INTERNO INTERNE



Tipo Nippondenso.  
Type Nippondenso.  
Tipo Nippondenso.  
Type Nippondenso

CORREAS		BELTS	CINGHIE	COURROIE
REF	OEM			UNIDADES X ALTERNADOR UNITS X ALTERNATOR UNITÀ X ALTERNATORE UNITÉS X ALTERNATEUR
REC25132-003000	25132-003000	2GMSZK		
REC25132-003100	25132-003100	2GM20, -YEU 2GMLP		
REC25132-003700	25132-003700	2GM20F, F-YEU 3GM30, F-YEU		
REC128670-77350	128670-77350	3HM		
REC129612-42290E	129612-42290E	3YM20		
REC129940-42310E	129940-42310E	3JH3E-YEU-E 3JH4E 1GM10		
REC128170-77350	128170-77350	1GML 3GM 3HMF		
REC25132-004500	25132-004500	3JH2, E, L, -TCE 3JH25A 3JH3 4JH, -HTE, -HTZ, -HTZAE, -TE, -TZ 3JH5AE, E		
REC25152-004300	25152-004300	4JHAE 4JH4E, AE 4JH5E		
REC25132-004600	25132-004600	4JH2-DTE, E, -HTE, -TE, -UTE 4JH3, -TE, -HTE 4JH-DTE		
REC121850-42280E	121850-42280E	4LHA-DTE, -DTP, -DTZE, -DTZP, -HTE, -HTP, -HTZE, -HTZP, -STE, -STP, -STZE, -STZP 4LH-DTE, -DTZ, -HT, -HTE, -HTZ, -HTZAY, -ST, -STE, -STZ, -STZAY, -TE, -UT, -UTZ, -UTZAY, -WST, -WSTZY 6LYA-STE, -UTE, -STP 6LY2A-STP, -UTP		
REC119593-42280E	119593-42280	6LY2M-WDT, -WST 6LYM-UTE, -STE, -UTEHD 6LY-STE		
REC119593-42350	119593-42350	6LY2-STVY, -WDT, -WDTZY, -WST 6LY-ST, -STM, -STZY, -UT, -UTE, -UTM, -UTZY, -WST, -WSTZY, -WUT, -WUTZY 6GHA-ET, -ST, -STE		
REC25132-002700	25132-002700	6GHAK-ST1 6GHAM-STE 6GHD-ST		2
REC25132-004250E	25132-004250	6CX-ETE, -GT, M-ETE		2
REC119775-77260	119775-77260 119773-77250	6LPA-DTP, -DTZP, -STP, -STZ 6LP-DT, -DTE, -DTZE, -DTZY, -ST, -STE, -STZE, -STZY, -WDT, -WDTZY		2





SOLENOIDES Y RELÉS

SOLENOID & RELAY

SOLENOIDI E RELÉ



SOLENOID ET RELAIS

SOLENOIDE DE PARO

STOP SOLENOID



SOLENOIDI STOP

SOLENOIDE STOP

REF	OEM		
REC129271-77950	129271-77950	3JH/5E, 5EA 4JH/5E, 4E, 4AE 3YM/30, 27, 30R, 20, 27A, 30AE, 30R 2YM15	12V



new

REF	OEM		
REC876614	119171-67200	4JH & 4LH	12V

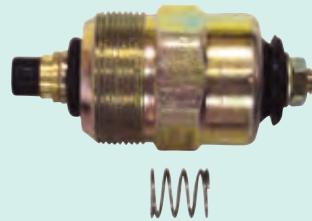

new

RELÉ

RELAY



RELÉ

RELAIS

REF	OEM	
REC124617-91850	124617-91850	12V





new

REF	OEM		
REC128990-77550	128990-77550 120270-77511	4JH 3YM 3JH 2YM	12V



new

REF	OEM		
REC128990-77911	128990-77911 128990-77910	4JH 3YM 3JH 2YM	12V



new

# SISTEMA DE REFRIGERACIÓN COOLING SYSTEM

# SISTEMA DI RAFFREDDAMENTO SYSTÈME DE REFROIDISSEMENT

## TERMOSTATO

## THERMOSTAT

## TERMOSTATO

## THERMOSTAT

REF	OEM	°C	
REC105582-49200	105582-49200 181130-49200 124223-49250	42	1GM, L, Y-C
			1GM10
			2GM20, -YEU
			2GMSZK
			3GM30
			3HM 3HM35





REF	OEM	°C	
REC119773-49550	119773-49550	70	6LPA-DTP, -DTZP, -STP, -STZ





REF	OEM	°C	
REC121750-49800	121750-49800	71	2GM20F, F-YEU 3GM30F, F-YEU 3HMF 3YM30AE 4JH2-DTE





REF	OEM	°C	
REC127605-48590	127605-48590	71	6LY2-ST, -STE, -STVY, -WDT, -WDTZY, -WST 6LY2A-STE, -STP, -UTP 6LY2M-WDT, -WST 6LY3-ETP, -STP, -UTP



REF	OEM	°C	
REC128990-49800	128990-49800	71	3YM20 3YM27A 3YM30





REF	OEM	°C	
REC129470-49801	129470-49801	76,5	3JH2M, E, L, -TCE 3JH25A 3JH3, E-YEU-E 3JH4E 3JH5AE, E 4JH 4JH2E, -HTE, -TE, -UTE 4JH3-DTE, -HTE, -TE 4JH4E, AE 4JH5E 4JHE, -HTE, -HTZ, -HTZAE, -TE, -TZ





REF	OEM	°C	
REC145640-48410	145640-48410	71	6CX-GT 6GHA-ET, -ST, -STE 6GHAK-ST1 6GHAM-STE 6GHD-ST 6KHL-ST



REF	OEM	°C	
REC121850-49811	121850-49811	71	4LHA-DTE, -DTP, -DTZE, -DTZP, -HTE, -HTP, -HTZE, -HTZP, -STE, -STP, -STZE, -STZP 4LH-DTE, -DTZ, -HT, -HTE, -HTZ, -HTZAY, -STE, -TE, -UT



REF	OEM	°C	
REC119593-49550	119593-49550	76,5	6LYM-UTE, -STE, -UTEHD 6LY-ST, -STE, -STM, -STZY, -UT, -UTE, UTM, -UTZY, -WST, -WSTZY, -WUT, -WUTZY



REF	OEM		
REC165000-69950	165000-69950	4BY 6BY	

**JUNTAS CUERPO DE TERMOSTATO**      **THERMOSTATO HOUSING, GASKET**      **GUARNIZIONE CORPO TERMOSTATO**      **JOINT CORS DE THERMOSTAT**

REF	OEM		
REC121450-44411	121450-44411 121450-44410	1GM, L, Y-C 1GM10 2GM20, F, F-YEU, -YEU 2GM, LP 3GMD, F 3GM30, F, F-YEU	

**JUNTAS TAPA DE TERMOSTATO**      **THERMOSTATO COVER, GASKET**      **GUARNIZIONE COPERCHIO TERMOSTATO**      **JOINT COUVERCLE DE THERMOSTAT**

REF	OEM		
REC104211-49160	104211-49160	1GM, L, Y-C 1GM10 2GM20, F, F-YEU, -YEU 2GM, LP 3GMD, F 3GM30, F, F-YEU	



REF	OEM		
REC129350-49541	129350-49541 129350-49540	2GMLP	





  





REF	OEM		
REC129795-49551	129795-49551	3JH 4JH	

**BOMBAS ASPIRACIÓN AGUA MARINA**      **RAW MARINE WATER PUMPS**      **POMPE ASPIRAZIONE ACQUA MARINA**      **POMPE D'EAU MARINE**



**BOMBAS DE AGUA**      **WATER PUMPS**      **POMPE ACQUA**      **POMPE D'EAU**



REF	OEM		REF. JOHNSON		
REC119574-42502	119574-42502 119574-42501 119574-42500	6LY2-ST, -STVY, -STE, -WST, -WDT, -WDTZY 6LY2A-STP, -UTP 6LYA-STP, -STE, -UTE 6LY2M-WDT, -WST	10-13170-01	REC119574-42550	



REF	OEM		REF. JOHNSON			
REC129271-42502	129271-42502 129271-42501 129271-42500	3JH4E 3JH5A, AE, E 3JH40 4JH4AE, E 4JH5E 4JH80 4JH110 4JH45 4JH57	10-13328-03	REC21213660	REC129150-01881	

REF	OEM		REF. JOHNSON			
REC128397-42500	128397-42500 128377-42500 121575-42200 128990-42510	2GM20-YEU, C-YEU, F-YEU, FC-YEU 3GM30-YEU, C-YEU, F-YEU, FC-YEU 2YM15 3YM20 3YM30	10-1333701 10-24509-01	REC653-0001	1/2"	

REF	OEM			
REC728270-42002	128270-42000 128270-42001 128270-42002	2GM, F, L, YE-EC 2GM20, VE, B, C 2GMZ 3GTM 3GMF, LE 3HM, F 3GM30, VE, B, C	CEF500100GX	

REF	OEM		REF. JOHNSON			
REC129670-42513	129670-42513 129670-42512 429670-42511 429670-42510 129670-42500 129670-42501 129670-42502	3JH3E, -EPA, CE, E-YEU-E 3JH4E 4JH3E, CE, CE1, -TE, -TCE, -HTE, -DTE 4JH4E, -TE, -HTE, -HTE-1	10-13328-04	REC21213660	REC129150-01881	

REF	OEM		REF. JOHNSON		
REC119578-42501	119578-42501 119578-42500	6LPY3-ETP 6LY3-STP, -UTP, -STC, -UTC, -ETP-24, -STP-24, -UTP-24, -STC-24, -UTC-24	10-1286-01	CEF500162G	

REF	OEM		REF. JOHNSON		
REC119773-42502	119773-42502 119773-42501 119773-42650 119773-42651 119773-42652	6LP-DTE, -STE, -DTE, -DT, -ST, -WDT, -WST 6LPA-DTE, -DTP, -STE, -STP, -STP2  Los modelos siguientes necesitan las tomas antiguas: The following models need the old water intake: I seguenti modelli richiedono i vecchi entrata d'acqua: Les modèles suivants nécessitent les anciennes douilles : 6LP-DTZE, -STZE, -DTZY, -STZY, -STZYJ 6LPA-STZP, -DTZP1, -STZE, -STZEP1, -STZP2, -STZP3	10-24493-01	REC13554-0001	

JUNTAS BASE DE LA BOMBA	PUMPS BASE GASKET	GUARNIZIONE BASE POMPE ACQUA	JOINTS BASE POMPE D'EAU
-------------------------	-------------------	------------------------------	-------------------------

REF	OEM	
REC129486-42050	129486-42050 129150-42020	3JH2, -TCE, E, 2L 3JH25A 3JH3, E-YEU-E 3JH4E 3JH5AE, E 4JH, -DTE, -HTE, -HTZ, -HTZAE, -TE, -TZ 4JH2-DTZ, -DTE, -HTE, -TE, E, -UTE 4JH3-DTZ, ZA, -CE, -TCE, -TE, E, -DTE, -HTE





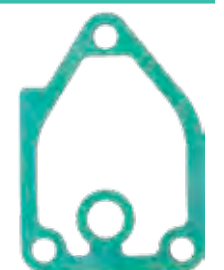

REF	OEM	
REC129150-35111	129150-35111	3JH 4JH





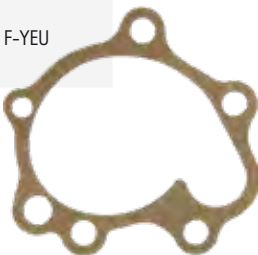

REF	OEM	
REC119000-42021	119000-42021	4LH-DTE, -HTE, -STE, -TE, -DTZ, -HT, -HTZ, -HTZAY, -ST, -STZ, -STZAY, -UT, -UTZ, -UTZAY, -WST, -WSTZY 4LHA-DTE, -DTZE, -DTZP, -HTE, -HTP, -HTZE, -HTZP, -STE, -STP, -STZE, -STZP





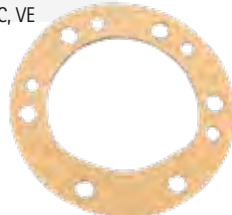

JUNTAS DE LA BOMBA		GASKETS PUMP	GUARNIZIONE POMPE ACQUA	JOINTS POMPE D'EAU	
REF	OEM		REF	OEM	
REC121000-42052	121000-42052 121000-42051 121000-42050	1GM, L, Y-C 1GM10 2GM20, F, -YEU, F-YEU 2GMLP 3GM, D, F 3GM30, F, F-YEU 3HM, F 3HM35	REC129150-01881	129150-01881	3JH2, -TCE, E 3JH25A 3JH3, E-YEU-E 3JH4E 3JH5AE, E 4JH, -DTE, -HTZ, -HTZA, -TZ, -TE
					

JUNTAS TAPA DE LA BOMBA		PUMPS COVER GASKET	GUARNIZIONE COPERCHIO POMPE ACQUA	JOINTS COUVERCLE POMPE D'EAU	
REF	OEM		REF	OEM	
REC128170-42090	128170-42090	1GM 1GM10, -B, C, L, VE	REC124223-42110	124223-42110	2GMF 2GM20F, FVE 3GMF 3GM30F, FVE 3HM, F 3HM35, C, F
					

REF	OEM		REF	OEM	
REC104211-42090	104211-42090	2GM, F 2GM20, B, C, VE 3GM 3GMD 3GM30, B, C, VE	RECX02173476	X02173476 X0506597	2YM15 3YM20, 30, 27A, 30R, 30AE
					

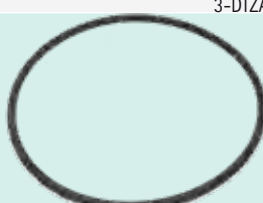
REF	OEM		REF	OEM	
REC119773-42570	119773-42570	4JH110, 57, 45, 80 3JH40	REC24341-000600	24341-000600	3JH30A 4JHZ, -DTZY, -TZ2, 2-DTZ, 3-DTZ, DTZ, TZA, -TZ1, 3-DTZAY, JH2
					

CORREA BOMBA		PUMPS BELT	CINGHIE POMPA	COURROIE POMPE
REF	OEM			
REC104511-78780E	104511-78780E	2GM20, F, F-YEU, -YEU 3GM30, F, F-YEU 3HM, F 3HM35		

KITS JUNTAS ENFRIADOR AIRE

AIRCOOLER GASKETS, KITS

KIT GUARNIZIONE RAFFREDATORE ARIA

KITS JOINTS REFFROIDISSEURS AIR

4JH SERIES

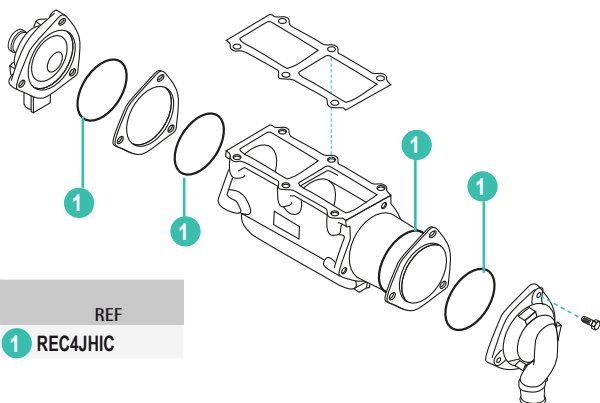

4LH SERIES

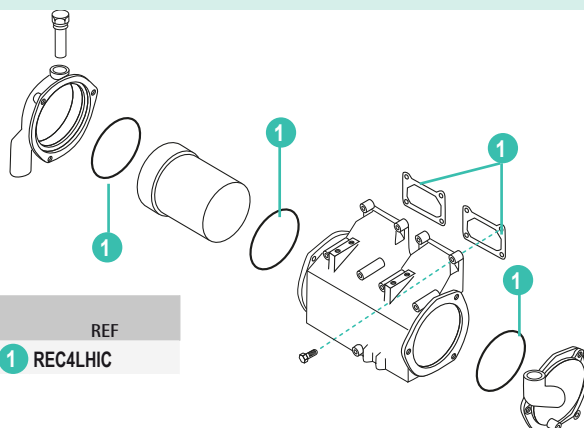

6LP SERIES

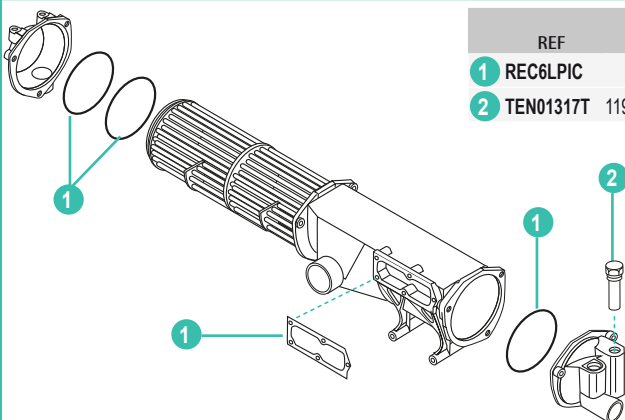

REF	OEM				
1 REC6LPIC		KIT	KIT	KIT	KIT
2 TEN01317T	119574-18790	ÁNODO COMPLETO	ANODE ASSY	ANODO COMPLETO	ANODE COMPLET

6LY SERIES

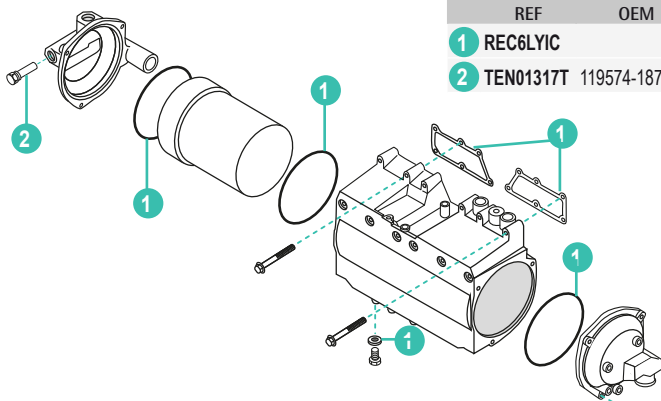

REF	OEM				
1 REC6LYIC		KIT	KIT	KIT	KIT
2 TEN01317T	119574-18790	ÁNODO COMPLETO	ANODE ASSY	ANODO COMPLETO	ANODE COMPLET

GUÍA ENFRIADOR AIRE

INTER COOLER GUIDE

GUIDA RAFFREDATORE ARIA

GUIDE REFFROIDISSEURS AIR

KIT	REF	TÓRICA	O-RING	FASCIA TONDA	JOINT TORIQUE	UN.
REC4JHIC	129672-18170	TÓRICA	O-RING	FASCIA TONDA	JOINT TORIQUE	4
	129573-18120	JUNTA	GASKET	GUARNIZIONE	JOINT	1
REC4LHIC	119773-18350	TÓRICA	O-RING	FASCIA TONDA	JOINT TORIQUE	3
	119175-18590	JUNTA	GASKET	GUARNIZIONE	JOINT	2
	127677-33060	TÓRICA	O-RING	FASCIA TONDA	JOINT TORIQUE	1
REC6LYIC	119578-18420	TÓRICA	O-RING	FASCIA TONDA	JOINT TORIQUE	3
	23414-080000	JUNTA	GASKET	GUARNIZIONE	JOINT	1
	119595-18600	JUNTA	GASKET	GUARNIZIONE	JOINT	2
REC6LPIC	119773-18350	TÓRICA	O-RING	FASCIA TONDA	JOINT TORIQUE	3
	119773-18121	JUNTA	GASKET	GUARNIZIONE	JOINT	1

KITS JUNTAS ENFRIADOR AGUA

COOLER GASKETS, KITS

KIT GUARNIZIONE RAFFREDDATORE ACQUA

KITS JOINTS REFFROIDISSEUR EAU

2GM SERIES

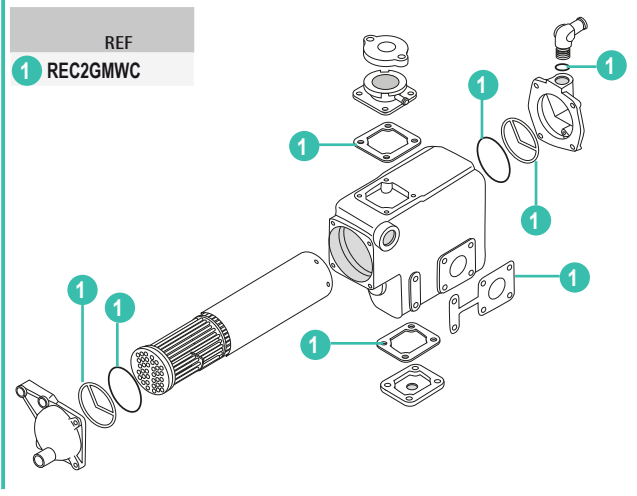

3GM SERIES

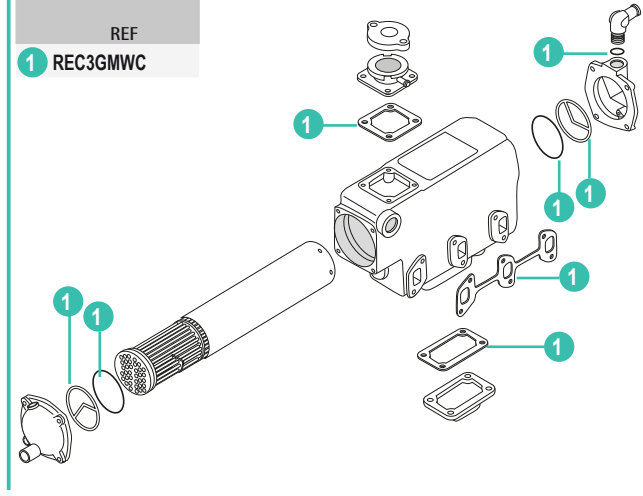

3JH SERIES

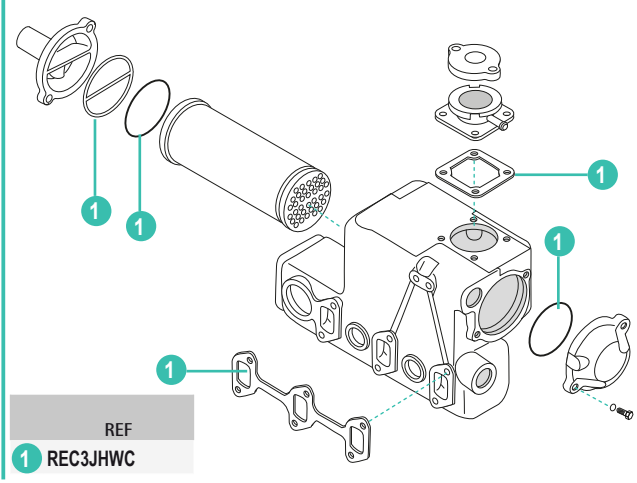

3YM SERIES  
20 / 27 / 30

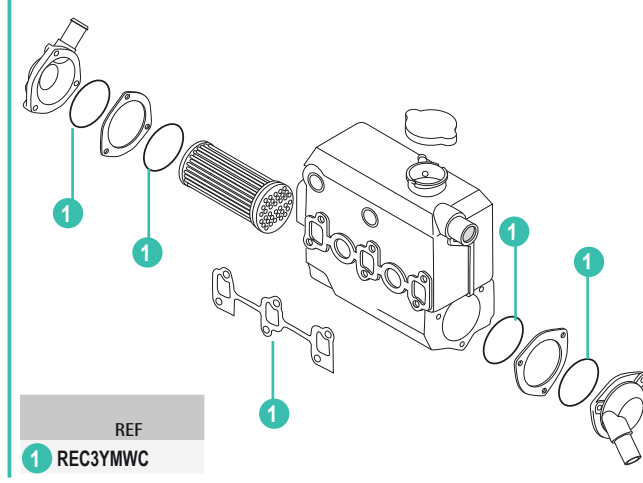

4JH SERIES

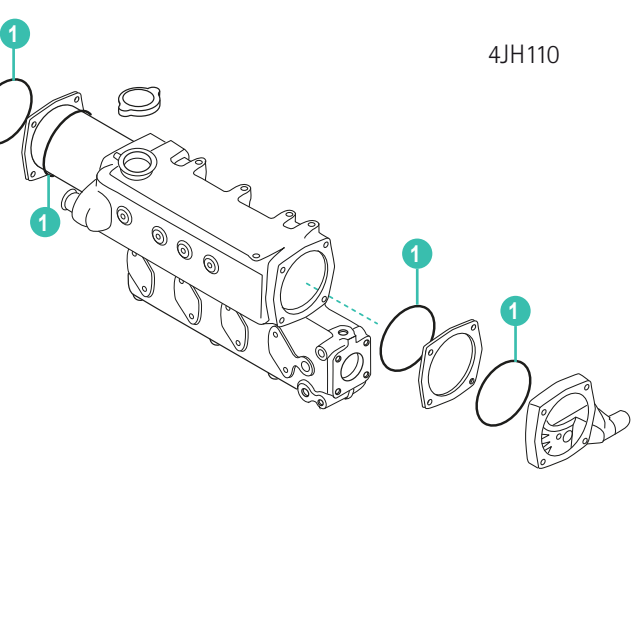
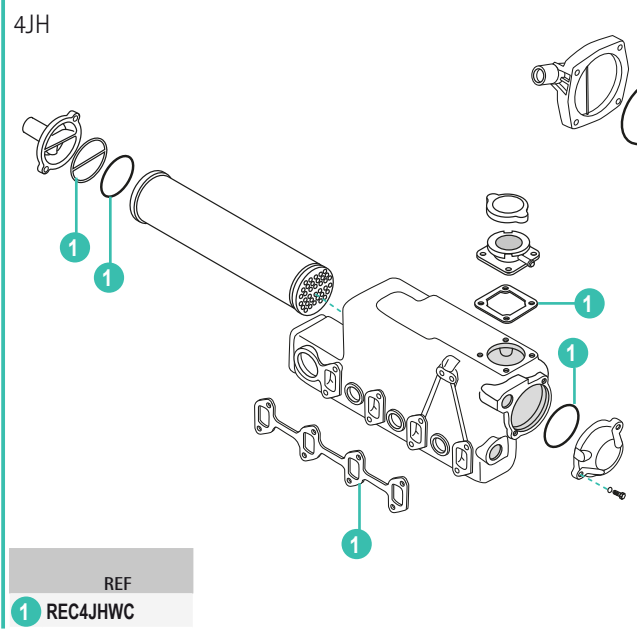

4LHA SERIES

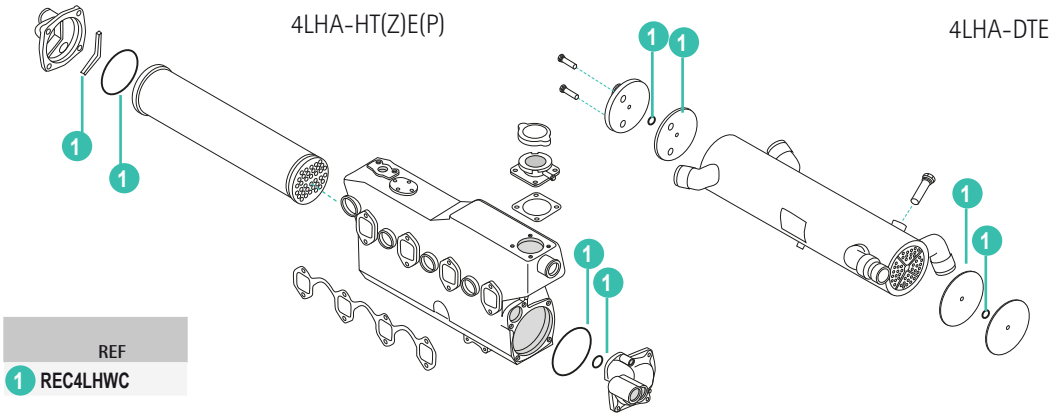

REF
1 REC4LHWC

6LY SERIES

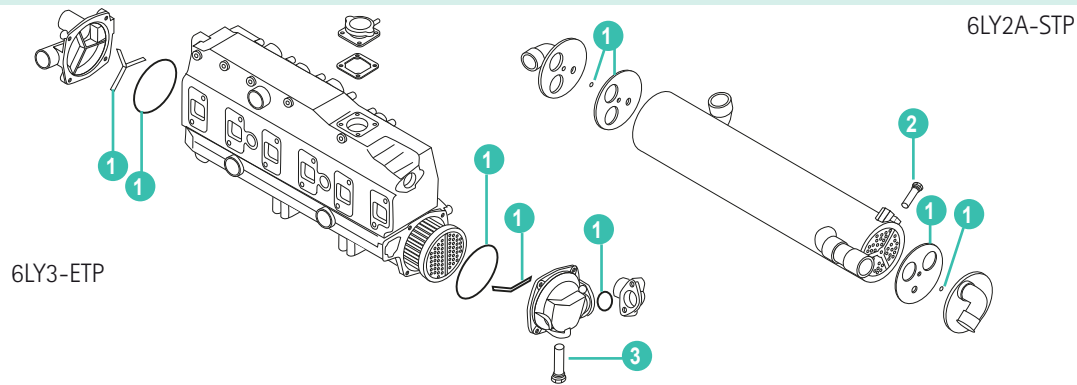

REF	OEM	KIT	KIT	KIT	KIT
1 REC6LYWC					
2 TEN01318T	119574-44150	ÁNODO COMPLETO	ANODE ASSY	ANODO COMPLETO	ANODE COMPLET
3 TEN01303	27210-200200	ANODO	ANODE	ANODO	ANODE

6LP SERIES

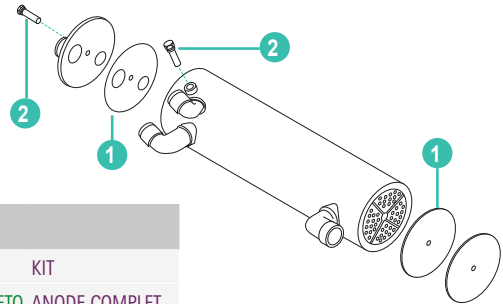

REF	OEM	KIT	KIT	KIT	KIT
1 REC6LPWC					
2 TEN01318T	119574-44150	ÁNODO COMPLETO	ANODE ASSY	ANODO COMPLETO	ANODE COMPLET

GUÍA JUNTAS ENFRIADOR AGUA

COOLING FRESH WATER COOLER

GUIDA GUARNIZIONE RIFREDDATORE ACQUA

GUIDE JOINTS REFROIDISSEUR D'EAU

KIT	REF	TÓRICA	O-RING	FASCIA TONDA	JOINT TORIQUE	UN.
REC2GMWC	128695-44070	TÓRICA	O-RING	FASCIA TONDA	JOINT TORIQUE	2
	24311-000700	TÓRICA	O-RING	FASCIA TONDA	JOINT TORIQUE	2
	123682-44201	JUNTA	GASKET	GUARNIZIONE	JOINT	1
	24311-000160	TÓRICA	O-RING	FASCIA TONDA	JOINT TORIQUE	1
	128290-13251	JUNTA	GASKET	GUARNIZIONE	JOINT	1
REC3GMWC	121450-11681	JUNTA	GASKET	GUARNIZIONE	JOINT	1
	128297-44030	TÓRICA	O-RING	FASCIA TONDA	JOINT TORIQUE	2
	128695-44070	TÓRICA	O-RING	FASCIA TONDA	JOINT TORIQUE	2
	24311-000700	TÓRICA	O-RING	FASCIA TONDA	JOINT TORIQUE	2
	123682-44201	GASKET	GASKET	GUARNIZIONE	JOINT	1
	24311-000160	O-RING	O-RING	FASCIA TONDA	JOINT TORIQUE	1
121450-13251	GASKET	GASKET	GUARNIZIONE	JOINT	1	
128390-44491	GASKET	GASKET	GUARNIZIONE	JOINT	1	



KIT	REF					UN.
REC3YMWC	128990-44100	TÓRICA	O-RING	FASCIA TONDA	JOINT TORIQUE	4
	119717-13110	JUNTA	GASKET	GUARNIZIONE	JOINT	1
REC3JHWC	120322-33050	TÓRICA	O-RING	FASCIA TONDA	JOINT TORIQUE	1
	24321-000750	TÓRICA	O-RING	FASCIA TONDA	JOINT TORIQUE	2
	129670-44150	TÓRICA	O-RING	FASCIA TONDA	JOINT TORIQUE	2
	120445-44611	JUNTA	GASKET	GUARNIZIONE	JOINT	1
	129150-13110	JUNTA	GASKET	GUARNIZIONE	JOINT	1
REC4JHWC	129693-44420	TÓRICA	O-RING	FASCIA TONDA	JOINT TORIQUE	2
	127677-33060	TÓRICA	O-RING	FASCIA TONDA	JOINT TORIQUE	4
	129573-44470	TÓRICA	O-RING	FASCIA TONDA	JOINT TORIQUE	2
	120322-33050	TÓRICA	O-RING	FASCIA TONDA	JOINT TORIQUE	2
	129672-44150	TÓRICA	O-RING	FASCIA TONDA	JOINT TORIQUE	2
	120445-44611	JUNTA	GASKET	GUARNIZIONE	JOINT	1
	24321-000800	TÓRICA	O-RING	FASCIA TONDA	JOINT TORIQUE	2
	24321-000750	TÓRICA	O-RING	FASCIA TONDA	JOINT TORIQUE	2
	24321-001000	TÓRICA	O-RING	FASCIA TONDA	JOINT TORIQUE	2
	129550-13110	JUNTA	GASKET	GUARNIZIONE	JOINT	1
REC4LHWC	119174-44470	RETÉN	SEAL	TENUTE	JOINT D'HUILE	1
	119171-44470	RETÉN	SEAL	TENUTE	JOINT D'HUILE	1
	24311-001000	TÓRICA	O-RING	FASCIA TONDA	JOINT TORIQUE	2
	24311-001200	TÓRICA	O-RING	FASCIA TONDA	JOINT TORIQUE	2
	24311-000300	TÓRICA	O-RING	FASCIA TONDA	JOINT TORIQUE	2
	119175-33350	TÓRICA	O-RING	FASCIA TONDA	JOINT TORIQUE	2
	119175-33380	JUNTA	GASKET	GUARNIZIONE	JOINT	1
119175-33370	JUNTA	GASKET	GUARNIZIONE	JOINT	1	
REC6LYWC	119578-44420	RETÉN	SEAL	TENUTE	JOINT D'HUILE	1
	119578-44350	TÓRICA	O-RING	FASCIA TONDA	JOINT TORIQUE	2
	119578-44430	RETÉN	SEAL	TENUTE	JOINT D'HUILE	1
	24311-000400	TÓRICA	O-RING	FASCIA TONDA	JOINT TORIQUE	1
	119175-33350	TÓRICA	O-RING	FASCIA TONDA	JOINT TORIQUE	2
REC6LPWC	119574-44170	JUNTA	GASKET	GUARNIZIONE	JOINT	2
	119773-44080	JUNTA	GASKET	GUARNIZIONE	JOINT	1
	119773-44071	JUNTA	GASKET	GUARNIZIONE	JOINT	1

KITS JUNTAS ENFRIADOR ACEITE	OIL COOLER GASKETS, KITS	KIT GUARNIZIONE RAFFREDATORE OLIO	KITS REFFROIDISSEURS D'HUILE
------------------------------	--------------------------	-----------------------------------	------------------------------

4JH SERIES

REF
1 REC4JHOC

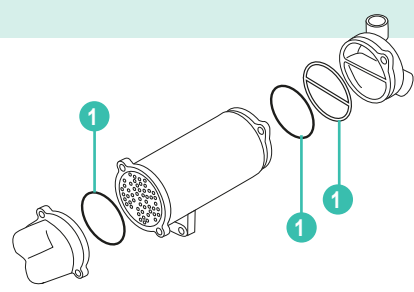

4LH SERIES

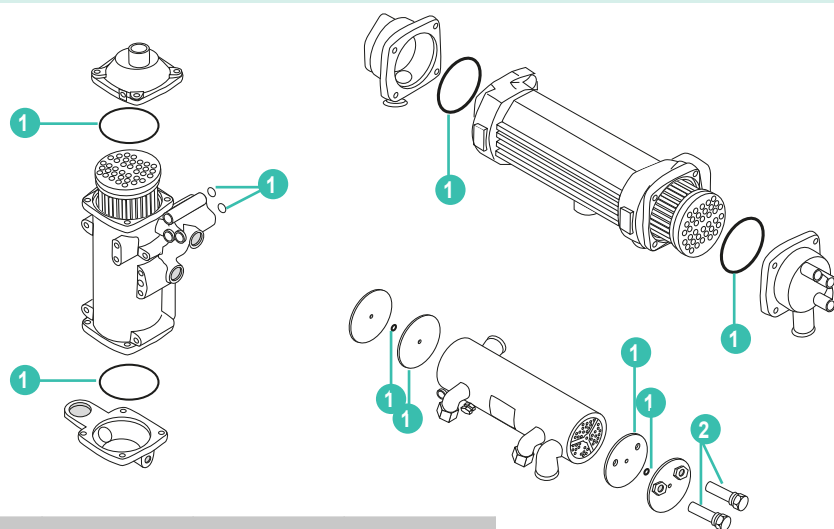

REF	OEM				
1 REC4LHOC		KIT	KIT	KIT	KIT
2 TEN01318T	ÁNODO COMPLETO	ANODE ASSY	ANODO COMPLETO	ANODE COMPLET	

6LP SERIES

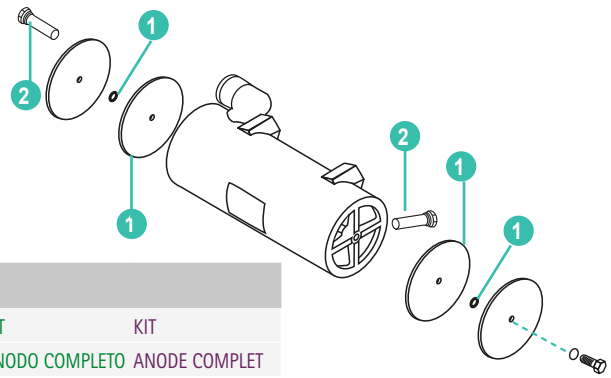

REF	OEM	KIT	KIT	KIT	KIT
1 REC6LPOC					
2 TEN01318T	119574-44150	ÁNODO COMPLETO	ANODE ASSY	ANODO COMPLETO	ANODE COMPLET

6LYOC SERIES

6LY3-ETP

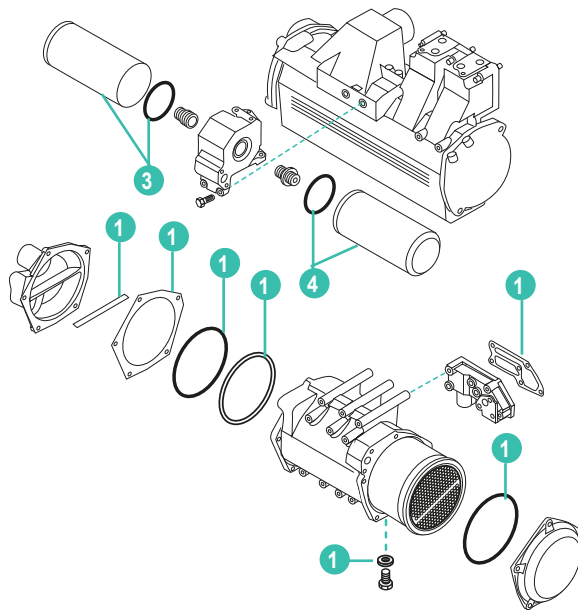

6LY2-STP

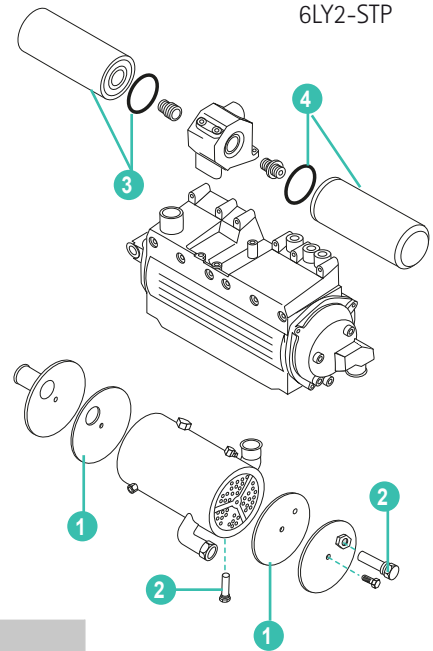

REF	OEM	KIT	KIT	KIT	KIT
1 REC6LYOC					
2 TEN01318T	119574-44150	ÁNODO COMPLETO	ANODE ASSY	ANODO COMPLETO	ANODE COMPLET
3 REC119593-35100	119593-35100	FILTRO ACEITE	OIL FILTER	FILTRO OLIO	FILTRE HUILE
4 REC119593-35400	119593-35400	FILTRO ACEITE	OIL FILTER	FILTRO OLIO	FILTRE HUILE

GUÍA ENFRIADORES DE ACEITE

OIL COOLER GUIDE

GUIDA RAFFREDRATORS D'OLIO

GUIDE REFFROIDISSEURS D'HUILE

KIT	REF					UN.
REC4JHOC	24321-000750	TÓRICA	O-RING	FASCIA TONDA	JOINT TORIQUE	2
	24321-000800	TÓRICA	O-RING	FASCIA TONDA	JOINT TORIQUE	1
	120322-33050	TÓRICA	O-RING	FASCIA TONDA	JOINT TORIQUE	1
	129673-33050	TÓRICA	O-RING	FASCIA TONDA	JOINT TORIQUE	1
REC4LHOC	24311-000180	TÓRICA	O-RING	FASCIA TONDA	JOINT TORIQUE	2
	24311-000900	TÓRICA	O-RING	FASCIA TONDA	JOINT TORIQUE	2
	119175-33350	TÓRICA	O-RING	FASCIA TONDA	JOINT TORIQUE	2
	119175-33370	JUNTA	GASKET	GUARNIZIONE	JOINT	1
	119175-33380	JUNTA	GASKET	GUARNIZIONE	JOINT	1
REC6LYOC	119574-33150	JUNTA	GASKET	GUARNIZIONE	JOINT	1
	119574-66160	JUNTA	GASKET	GUARNIZIONE	JOINT	1
	119578-34020	JUNTA	GASKET	GUARNIZIONE	JOINT	1
	119578-33080	RETÉN	SEAL	TENUTA	JOINT D'HUILE	1
	119578-33121	JUNTA	GASKET	GUARNIZIONE	JOINT	1
	119578-33130	TÓRICA	O-RING	FASCIA TONDA	JOINT TORIQUE	1
	24321-001500	TÓRICA	O-RING	FASCIA TONDA	JOINT TORIQUE	1
	22190-100002	JUNTA	GASKET	GUARNIZIONE	JOINT	1
REC6LPOC	119773-33070	JUNTA	GASKET	GUARNIZIONE	JOINT	1
	119175-33370	JUNTA	GASKET	GUARNIZIONE	JOINT	1
	119175-33350	TÓRICA	O-RING	FASCIA TONDA	JOINT TORIQUE	2

# PARTES DEL MOTOR ENGINE PARTS

# PARTI MOTORE PIECES MOTEUR

## JUNTAS MOTOR ENGINE GASKETS GUARNIZIONE MOTORE JOINTS MOTEUR

### JUNTAS CULATA CYLINDER HEAD GASKETS GUARNIZIONE TESTATA JOINTS CULASSE

REF	OEM		KIT
REC128170-01331	128170-01331 128170-01330 128171-01911	1GM, L, Y-C	REC728170-92600
REC128171-01911	128171-01911 128171-01330	1GM10	REC728171-92601

  
 REC128170-01331

  
 REC128171-01911

new





REF	OEM		KIT
REC119415-01330	119415-01330	3YM15	REC728790-92600

REF	OEM		KIT
REC128271-01911	128271-01911	2GM20, F, F-YEU, -YEU 2GM1P	REC728271-92605





new



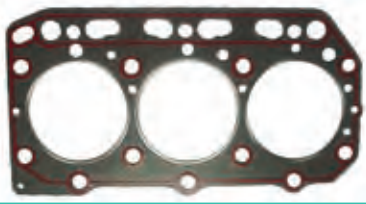

REF	OEM		KIT
REC119717-01331	119717-01330 119717-01331	3YM27 3YM30	REC728990-92600

REF	OEM		KIT
REC129002-01331	128271-01911	3JH3, E-YEU-E	REC729270-92601



REF	OEM		KIT
REC129001-01340	129001-01340	3JH4E 3JH5AE, E	REC729271-92600





REF	OEM		KIT
REC128374-01911	128374-01911	3GM30, F, F-YEU	REC728374-92605

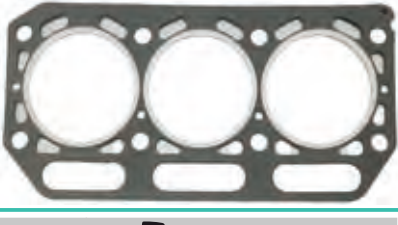

REF	OEM		KIT
REC128671-01330	128671-01330	3HM35	





REF	OEM		KIT
REC128370-01332	128370-01331 128370-01332	3GM, D, F	REC728370-92605





YANMAR

RECAMBIOS  
MARINOS

REF	OEM		KIT
REC129171-01330	129171-01330	3JH2, 25A, E, L, -TCE	REC729171-92600





REF	OEM		KIT
REC129407-01340	129407-01340	4JH4E, AE, 4JH5E	REC729407-92605





REF	OEM		KIT
REC121575-01334	121575-01334 121575-01333 121575-01332 121575-01331	3HM, F	





REF	OEM		KIT
REC129573-01351	129573-1351	4JH2-DTE, E, -HTE, -TE, -UTE	REC729573-92605





REF	OEM		KIT
REC128625-01342	128625-01342	6GHA-ET, -ST, -STE 6GHAK-ST1 6GHAM-STE 6GHD-ST	



REF	OEM		KIT
REC129693-01331	129693-01331	4JH3-DTE, -HTE	REC729693-92600



REF	OEM		KIT
REC129408-01330	129408-01330	4JH3, E, CE, ZA, 4JH3-TCE, -TE	REC729408-92605



REF	OEM		KIT
REC129553-01350	129553-01350	4JH-DTE, E, -HTE, -HTZ, -HTZAE, -TE, -TZ	REC729470-92605

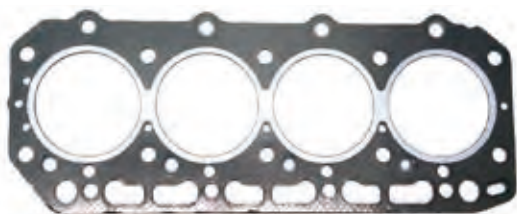



REF	OEM		KIT
REC119174-01340	119174-01340	4LH-TE, -HTE, -DTE, -STE, -HT, -HTZ, -HTZAY, -DTZ, -UT, -UTZAY, -UT2, -ST, -STZAY, -STZ, -WST, -WSTZY 4LHA-STE, -STP, -STZE, -STZP, -DTE, -DTP, -DTZE, -DTZP, -HTE, -HTP, -HTZE, -HTZP	REC719173-92600 REC719171-92602







### MARK1

REF	OEM	
REC119771-00401	119771-00401	6LP-ST, -STE, -STZE, -STZE1, -STZY, -STZYJ, -WST, -WSTZY





REF	OEM	
REC119770-00930	119770-00930	6LPA-DTE, -DTP, -DTZE, -DTZP, -DTZEP1 6LP-DT, -DETE, -DTP, -DTZE, -DTZE1, -DTZEP, -DTZEP1, -DTZY, -WDT, -WDTZY



### MARK3

REF	OEM	
REC119770-00940	119770-00940	6LPA-DTE, -DTP, -DTZE, -DTZP, -DTZEP1 6LP-DT, -DETE, -DTP, -DTZE, -DTZE1, -DTZEP, -DTZEP1, -DTZY, -WDT, -WDTZY





REF	OEM	
REC119771-00411	119771-00411	6LP-ST, -STE, -STZE, -STZE1, -STZY, -STZYJ, -WST, -WSTZY



### MARK5

REF	OEM	
REC119771-00421	119771-00421	6LP-ST, -STE, -STZE, -STZE1, -STZY, -STZYJ, -WST, -WSTZY



REF	OEM	
REC119770-00950	119770-00950	6LPA-DTE, -DTP, -DTZE, -DTZP, -DTZEP1 6LP-DT, -DETE, -DTP, -DTZE, -DTZE1, -DTZEP, -DTZEP1, -DTZY, -WDT, -WDTZY



### KIT JUNTAS

### GASKET SETS

### KIT GUARNIZIONI

### JOINTS CULASSE

REF	OEM	
REC728170-92600	728170-92600	1GM 1GML

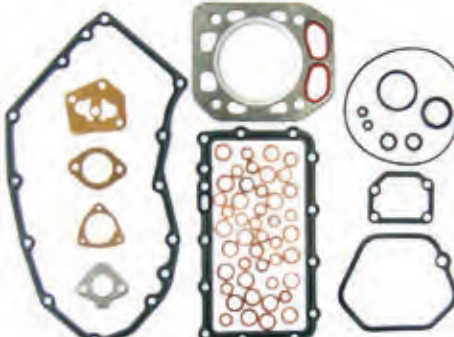



REF	OEM	
REC728171-92601	728176-92600 728171-92601	1GMY-C 1GM10



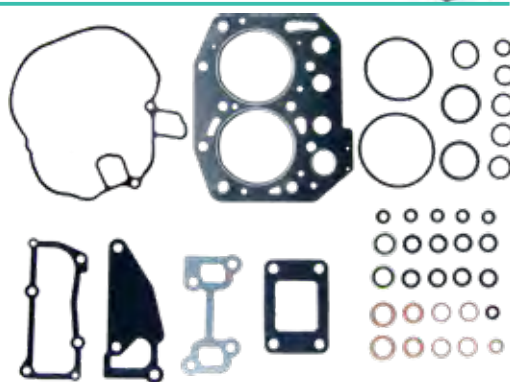

REF	OEM	
REC728790-92600	728790-92600	2YM15



REF	OEM	
REC728271-92605	728271-92605	2GM20, F



REF	OEM	
REC729271-92600	729271-92600	3JH4E 3JH5



REF	OEM	
REC728374-92605	728374-92605 728370-92600	3GM30, F, F-YEU 3GM, F, D

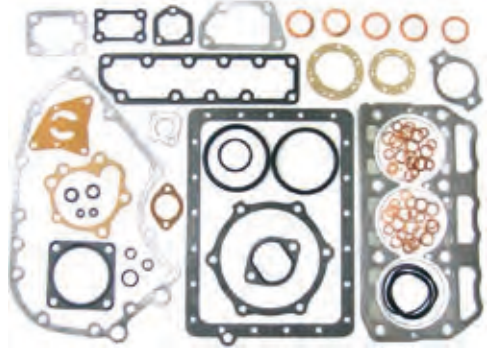

REF	OEM	
REC728990-92600	728990-92600	3YM30

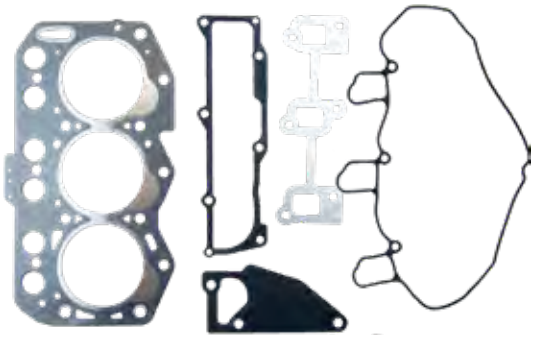

REF	OEM	
REC729171-92600	729171-92600	3JH2, E, L, -TCE

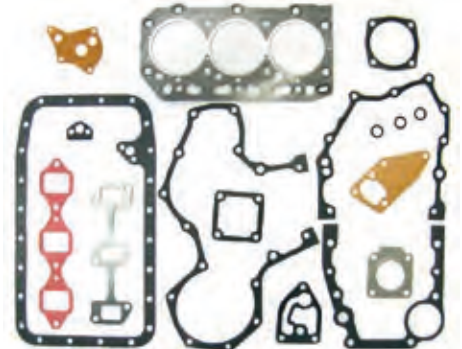

REF	OEM	
REC729693-92600	729693-92699	4JH3-DTE, -HTE, -TE, -TCE

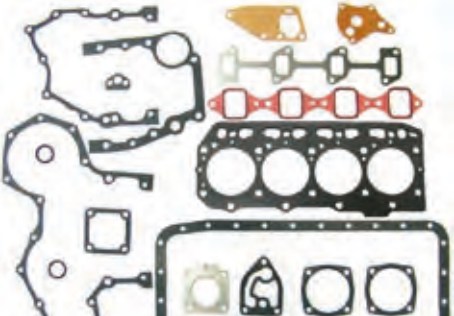

REF	OEM	
REC729270-92601	729270-92601	3JH3E-YEU-E

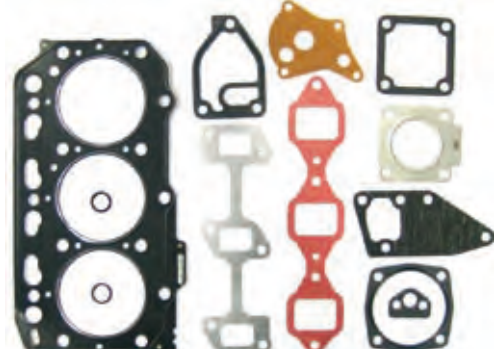

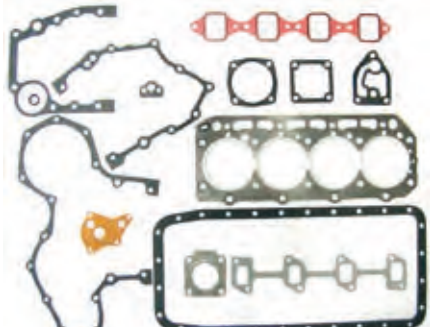

REF	OEM	
REC729573-92605	729573-92605	4JH2-DTE, E, -HTE, -TE, -UTE





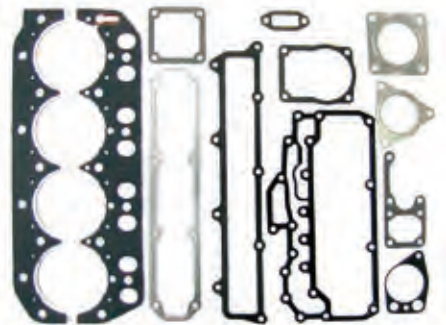

REF	OEM	
REC719171-92602	719171-92602	4LH-HTE, -STE, -TE

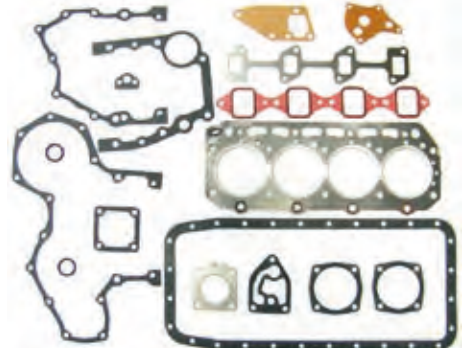

REF	OEM	
REC729470-92605	729470-92605	4JH-DTE, E, -HTE, -HTZ, -HTZAE, -TE, -TZ 4JH4E, AE



REF	OEM	
REC729408-92605	729408-92600 729408-92605	4JH3, CE, 3E, ZA

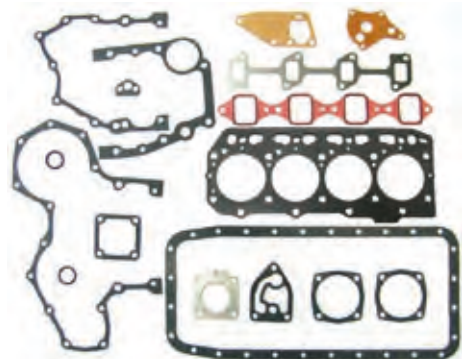

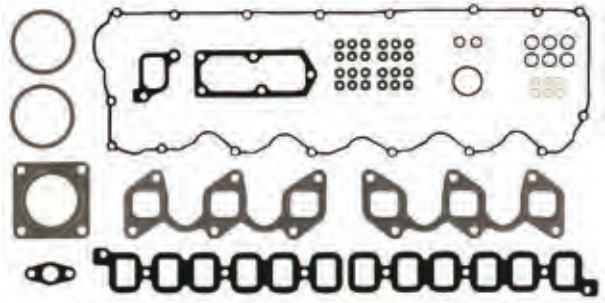

REF	OEM	
REC040122		6LP-STE, -STP, -STZE, -STZE1 6LPA-STE, -STP, -STZP



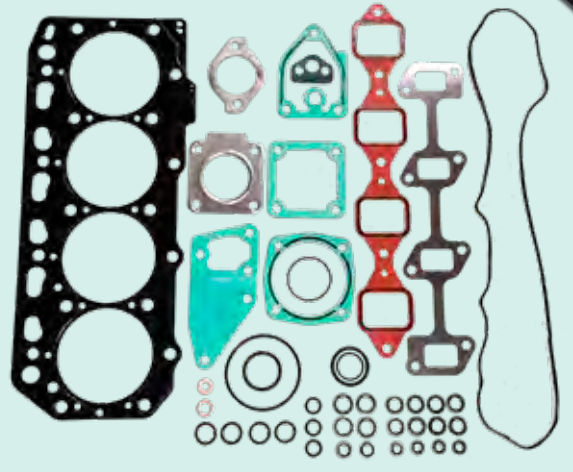

new

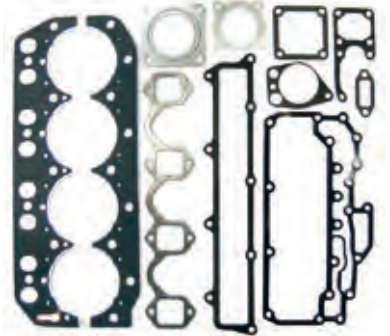

REF	OEM		KIT
REC729670-92600	729670-92600	4JH4E 4JH4AE 4JH5E	REC728990-92600

REF	OEM	
REC719173-92600	719173-92600	4LHA-DTE, -DTP, -DTZE, -DTZP, -HTE, -HTP, -HTZE, -HTZP, -STE, -STP, -STZE, -STZP, -DTE



REF	OEM	
REC930122	930122	6LP-DTP, -DTZE, -DTZE1, -DTZP, -DTZP1 6LPA-DTE, -DTP, -DTZE, -DTZP

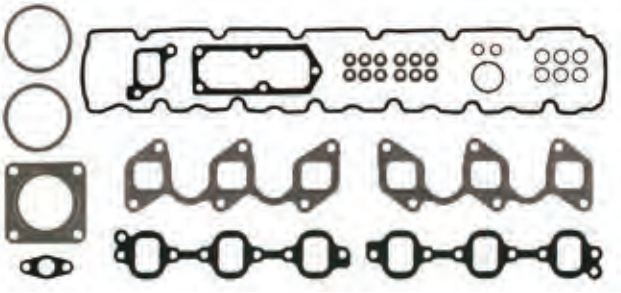

KITS SIN JUNTA CULATA

KIT, WITHOUT HEAD GASKET

KIT SENZA GUARNIZIONE TESTATA

KITS SANS JOINT DE CULASSE

REF  
YANMAR1GMSERIES



REF  
YANMAR2GMSERIES



REF  
YANMAR3GMSERIES



REF  
YANMAR4JHSERIES



REF  
YANMAR4LHSERIES



GUIA KITS DE JUNTAS

GASKETS KIT, APPLICATION

GUIDA KIT GUARNIZIONI

GUIDE KITS DE JOINTS

KIT	JUNTA CULATA CYL HEAD GASKET GASKET TESTA JOINT DE CULASSE	KIT	JUNTA CULATA CYL HEAD GASKET GASKET TESTA JOINT DE CULASSE
YANMAR1GMSERIES	REC128170-01331	YANMAR4JHSERIES	REC129407-01340
YANMAR1GMSERIES	REC128171-01911	YANMAR4JHSERIES	REC129573-01351
YANMAR2GMSERIES	REC128271-01911	YANMAR4JHSERIES	REC129693-01331
YANMAR3GMSERIES	REC128374-01911	YANMAR4JHSERIES	REC129593-01350
YANMAR3GMSERIES	REC128370-01332	YANMAR4LHSERIES	REC119174-01340
YANMAR4JHSERIES	REC129408-01330	YANMAR4LHSERIES	REC119174-01340

JUNTAS TAPA BALANCINES

VALVE COVER GASKET

GUARNIZIONI COPERCHIO PUNTERIE

JOINTS COUVRE-SOUPAPE

REF	OEM	
REC128170-11310	128170-11310	1GM, 10, L, Y-C



REF	OEM	
REC128270-11310	128270-11310	2GM 2GM20, F, F-YEU, -YEU





REF	OEM	
REC121450-11310	121450-11310	3GM30, F, F-YEU 3GMF, 30D



REF	OEM	
REC119770-00060	119770-00060	6LP-DTE, -DTP, -DTZE, -DTZE1, -DTZP, -DTZP1 6LPA-DTE, -DTP, -DTZE, -DTZP



REF	OEM	
REC119100-11360	119100-11360	4LHA-DTE, -DTP, -DTZE, -DTZP, -HTE, -HTP, -HTZE, -HTZP, -STE, -STR, -STZE, -STZP 4LH-DTE, -HTE, -STE, -TE

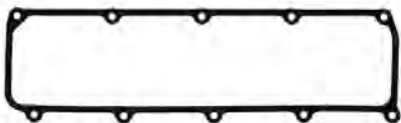

REF	OEM	
REC119593-11380	119593-11380	6LY-STE, -UTE 6LYA-STE, -STP, -UTE, -UTP 6LY2-STE, -STP 6LY2A-STE, -STP



REF	OEM	
REC129601-11310	129601-11310	4JH



REF	OEM	
REC119771-00040	119771-00040	6LP-STE, -STP, -STZE, -STZE1 6LPA-STE, -STP, -STZP

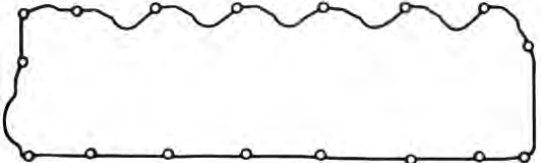

**JUNTAS COLECTOR DE ADMISION INTAKE MANFOLD GASKET**

**GUARNIZIONE COLLETTORE ASPIRAZIONE JOINTS CATER ADMISION ASPIRAZIONE**

REF	OEM	
REC129150-12111	129150-12111	3JH2, -TCE, E, L 3JH25A 3JH3, -YEU-E 3JH4E 3JH5AE, E



REF	OEM	
REC119100-12113	119100-12113	4LH-DTE, -DTZ, -HT, -HTE, -HTZ, -HTZAY, -ST, -STE, -STZ, -STZAY, -TE, -UT, -UTZ, -UTZAY, -WST, -WSTZY 4LHA-DTE, -DTP, -DTZE, -DTZP, -HTE, -HTP, -HTZE, -HTZP, -STE, -STP, -STZE, -STZP



**JUNTAS TAPA DE ADMISION INTAKE COVER GASKET**

**GUARNIZIONE COPERCHIO ASPIRAZIONE JOINTS COUVERCLE ADMISION**

REF	OEM	
REC129150-77511	129150-77511	3JH2, -TCE, E, L 3JH25A 3JH3, -YEU-E 3JH4E 3JH5AE, E



REF	OEM	
REC129470-12130	129470-12130	4JH, -HTZ, -HTZAE, -TZ 4JH2-DTE, E, -HTE, -TE, -UTE 4JH3, E, CE, ZA, -TCE, -TE, -DTE, -HTE 4JH4E, AE 4JH5E



**JUNTAS COLECTOR DE ESCAPE EXHAUST MANIFOLD GASKET**

**GUARNIZIONE COLLETTORE DI SCARICO JOINTS COLECTEUR D'ECHAPPEMENT**

REF	OEM	
REC129150-13110	129150-13110	3JH2, E, L, -TCE 3JH25A 3JH4E 3JH5AE, E



REF	OEM	
REC129550-13110	129550-13110	4JH, -DTE, E, -HTE, -HTZ, -HTZAE, -TE, -TZ 4JH2-DTE, E, -HTE, -TE, -UTE 4JH3, E, CE, ZA, -TCE, -TE, -DTE, -HTE 4JH4E, AE 4JH5E





**JUNTAS TAPA DE ESCAPE EXHAUST COVER GASKET**

REF	OEM	
REC128370-13181	128370-13181	3GM30, F, F-YEU





**GUARNIZIONE COPERCHIO DI SCARICO**

REF	OEM	
REC119174-13201	119174-13201	4LH-DTE, -DTZ, -HT, -HTE, -HTZ, -ST, -HTZAY, -STE, -STZ, -STZAY, -TE, -UT, -UTZ, -UTZAY 4LHA-DTE, -DTP, -DTZE, -DTZP, -HTE, -HTP, -HTZE, -HTZP, -STE, -STP, -STZE



**JUNTAS CODOS DE ESCAPE EXHAUST ELBOW GASKET**

REF	OEM	
REC129472-18090	129472-18090	3JH2, E, L, -TCE 3JH225A 3JH3, E-YEU-E 3JH4E 3JH5AE, E 4JH2-DTE, E, -HTE, -TE, -UTE 4JH, E, -HTE, -HTZ, -HTZAE, -TE, -TZ 4JH3, E, CE, ZA, -TCE, -TE, -DTE, -HTE 4JH4AE 4JH5E



**GUARNIZIONE GOMITO DI SCARICO**

REF	OEM	
REC128170-13201	128170-13201	1GM 2GM





REF	OEM	
REC129472-13520	129472-13520	3JH 4JH



*new*

REF	OEM	
REC119171-13510	119171-13510	4LH-DTE, -DTZ, -HT, -HTE, -HTZ, -ST, -HTZAY, -STE, -STZ, -STZAY, -TE, -UT, -UTZ, -UTZAY



REF	OEM	
REC119173-18940	119173-18940	4LH-DTE



*new*

REF	OEM	
REC128370-13201	128370-13201	2GM 3GM



*new*

**JUNTAS TURBO TURBO GASKETS**

**GUARNIZIONI TURBINE**

**JOINTS TURBO**

REF	OEM	
REC128300-13230	128300-13230	4LH-DTE, -DTZ, -HT, -HTE, -HTZ, -ST, -HTZAY, -STE, -STZ, -STZAY, -TE, -UT, -UTZ, -UTZAY 4LHA-DTE, -DTP, -DTZE, -DTZP, -HTE, -HTP, -HTZE, -HTZP, -STE, -STP, -STZE 6LP-DT, -DTE, -DTZE, -DTZE1, -DTZY, -ST, -STE, -STZE, -STZE1, -STZY, -STZYJ



**RETÉN TAPA LATERAL BLOQUE**      **SEAL SIDE COVER BLOCK**      **GUARNIZIONE COPERCHIO LATERALE BLOCCO**      **JOINT COUVERCLE LATERAL DU BLOC**

REF	OEM	
REC121575-01861	121575-01861	1GM, 10, L, Y-C 2GM20, F, -YEU 2GMLP 3GM, D, F 3GM30, F, F-YEU 3HM, 35, F



**RETÉN TAPA BLOQUE**      **SEAL COVER BLOCK**      **GUARNIZIONE COPERCHIO BLOCCO**      **JOINT COUVERCLE DU BLOC**

REF	OEM	
REC124610-01862	124610-01862 124610-01861	4LH-TE, -HTE, -HTZ 4LHA-HTP, -HTZE, -HTZP 6LY-UT, -ST, -UTZY, -STZY, -UTM, -STM, -UTE, -STE, -WST, -WSTZY, WUT, WUTZY 6LYM-UTE, -STE, -UTEHD 6LY2-ST, -STVY, -STP, A-STP, A-UTP, -WDT, -WDTZY, -WST 6LYA-STE, -STP, -UTE

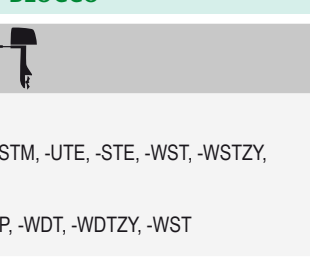

REF	OEM	
REC119000-01771	119000-01771	4LH-TE, -HTE, -HTZ 4LHA-HTP, -HTZE, -HTZP 6LY-UT, -ST, -UTZY, -STZY, -UTM, -STM, -UTE, -STE, -WST, -WSTZY, -WUT 6LYM-UT, -STE 6LY2-ST, -STVY, -STP, -WDT, -WDTZY, -WST 6LY2A-STP, -UTP 6LYA-STE, -STP, -UTE 6LYM-UTE, -UTEHD

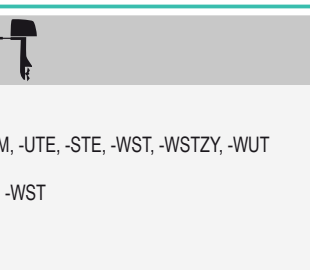

**JUNTAS TAPA VARILLA ACEITE**      **COVER GASKET OIL DIPSTICK**      **GUARNIZIONE COPERCHIO ASTA DI LIVELLO DELL'OLIO**      **JOINT COUVERCLE D'HUILE**

REF	OEM	
REC124160-34845	124160-34845 124160-34844	3GM, D, F 3GM30, F, F-YEU



**JUNTAS TAPA ÁNODO ZN**      **COVER GASKET ZN ANODE**      **GUARNIZIONE COPERCHIO ANODO ZN**      **JOINT COUVERCLE ANODE ZN**

REF	OEM	
REC121450-11681	121450-11681 121450-11680	2GM20, F, F-YEU, -YEU 2GMLP 3GM, D, F, F-YEU



**JUNTAS TAPA RESPIRADERO**      **BREATHER COVER GASKET**      **GUARNIZIONE COPERCHIO SFATATOIO**      **JOINT DE PLAQUE**

REF	OEM	
REC128170-03070	128170-03070	1GM, L, Y-C 1GM10



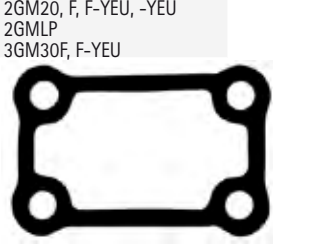
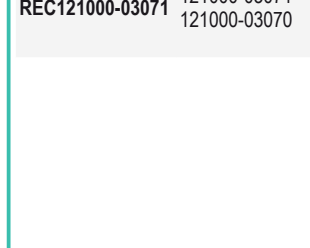

REF	OEM	
REC121000-03071	121000-03071 121000-03070	2GML 2GLMP 2GM20, F, F-YEU, -YEU 2GMLP 3GM30F, F-YEU





**JUNTAS DE CÁRTER**      **OIL PAN GASKET**      **GUARNIZIONE COPPA DELL'OLIO**      **JOINTS CARTER**

REF	OEM	
REC128170-01751	128170-01751 128170-01750	<b>1GM</b> <b>1GM10</b> , -B, C, L, VE





REF	OEM	
REC129198-01750	129198-01750	<b>3JH2</b> , BE, E, Z





REF	OEM	
REC124000-01751	124000-01751 124000-01750	<b>2GM20</b> , -YEU, B, C, C-YEU, F, F-YEU, FC-YEU



REF	OEM	
REC129400-01751	129400-01751	<b>4JH</b> , , E, -HT, -T, -TE <b>4JH2E</b> , -DTE, -HTE, -TE, -UTB, -UTE <b>4JH3</b> , ZA, -DTE, -HTE, -TCE, -TE



REF	OEM	
REC121000-01751	121000-01751 121000-01750	<b>3GM</b> , D, F <b>3GM30</b> , , -YEU, B, C, C-YEU, F, F-YEU, FC-YEU, FVE, VE



**JUNTAS BOMBA COMBUSTIBLE**      **FUEL PUMP GASKET**      **GUARNIZIONE POMPA COMBUSTIBILE**      **JOINT COUVERCLE POMPE ESSENCE**

REF	OEM	
REC121520-01851	121520-01851 121520-01850	<b>1GM</b> , L, LP, Y-C <b>1GM10</b> <b>2GM20</b> , F, F-YEU, -YEU <b>3GM</b> , D, F <b>3GM30</b> , F, F-YEU



**JUNTAS TAPA BOMBA**      **PUMP COVER GASKET**      **GUARNIZIONE COPERCHIO POMPA**      **JOINT COUVERCLE POMPE**

REF	OEM	
REC124240-01883	124240-01883 124240-01882	<b>2GM20</b> , F, F-YEU, -YEU <b>2GM1P</b> <b>3GM</b> , D, F <b>3GM30</b> , F, F-YEU

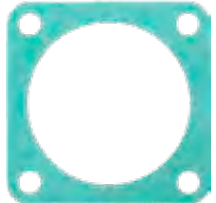

REF	OEM	
REC104211-42090	104211-42090	<b>1GM</b> , L, Y-C <b>2GM20</b> , F, F-YEU <b>2GH20</b> -YEU <b>2GM1P</b> <b>3GM</b> , D, F <b>3GM30</b> , F, F-YEU





**JUNTAS TAPA RETÉN TRASERO**

**REAR SEAL COVER GASKET**

**GUARN. COPERCHIO PARAOLIO POSTERIORE**

**JOINT SPI COUVERCLE ARRIÈRE**

REF	OEM	
REC105225-02040	105225-02040	2GM20, F, F-YEU, -YEU

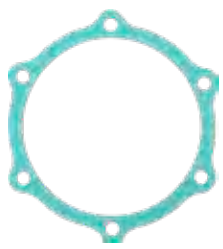

REF	OEM	
REC105582-82041	105582-82041	1GMY, -C, -EC 2GMFYE-E 2GMYE-EC



REF	OEM	
REC129100-01621	129100-01621	3JH25A

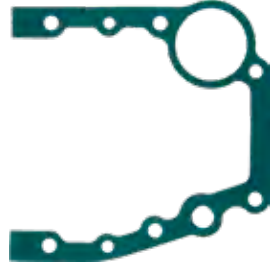



**JUNTAS TAPA RETÉN DELANTERO**

**FRONT SEAL COVER GASKET**

**GUARN. COPERCHIO PARAOLIO ANTERIORE**

**JOINT DE PLAQUE AVANT**

REF	OEM	
REC128170-01510	128170-01510	1GM, L, Y-C
	128170-01511	1GM10





REF	OEM	
REC129150-01531	129150-01531	3JH25A

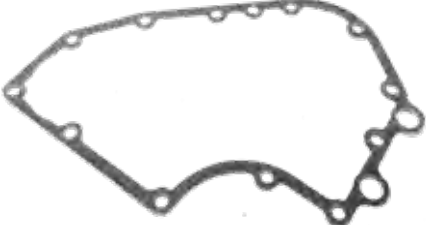

REF	OEM	
REC121575-01510	121575-01510	1GM, L, Y-C
	121575-01511	1GM10
	121575-01512	2GM20, F, F-YEU, -YEU
		2GMLP
		3GM, D, F
		3GM30, F, F-YEU



REF	OEM	
REC129150-01511	129150-01511	3JH25A



**IMPULSORES**

**IMPELLERS**

**GIRANTI**

**TURBINES**

REF	OEM	
CEF500113	128176-42080	1GM, L, Y-C
REC1411-0001		1GM10





REF	OEM	
REC3586494	104211-42070	2GM, SZK
	104211-42071	3GM30





REF	OEM	
REC653-0001	128990-42200	2GM20, F-YEU, -YEU
	128990-42570	3GM30, F-YEU



REF	OEM	
REC22779-0001	124223-42091	2GM20F
	124223-42092	3GM30F
	128296-42070	3HM, F
	128620-42200	3HM35





REF	OEM	
REC3841697	120650-42310	4LHA-DTE, -DTP, -DTZE, -DTZP, -HTE, -HTP, -HTZE, -HTZP, -STE, -STP, -STZE, -STZP
	127610-42200	4LH-DTE, -DTZ, -HT, -HTE, -HTZ, -HTZAY, -ST, -STE, -STZ, -STZAY, -TE, -UT, -UTZ, -UTZAY 4CH-DT





REF	OEM	
CEF500162G	119574-42550	6LY2-ST, -STE, -STVY
	119574-42552	



REF	OEM	
REC21213660	129470-42530 129470-42352 129670-42530 129670-42531	3JH2, E, L, -TCE
		3JH25A
		3JH3, E-YEU-E
		3JHAE
		3JH5AE, E
		4JH2-DTE, E, HTE, -TE, -UTE
		4JH3-HTE, -TE, -DTE
		4JH4E, AE
		4JH5E
		4JHE
4JH-HTE, -HTZ, -HTZAE, -TE, -TZ		





REF	OEM	
REC119574-42550	119574-42550	6LY2-WDT, -WDTZY, -WST 6LY2A-STE, -STP, -UTP 6LY2M-WDT, -WST 6LY3-ETP, -STP, -UTP 6LYA-STE, -STP, -UTE
	119574-42552	





REF	OEM	
REC128628-42203	128628-42203	6GHA-ET, -ST, -STE, K-STI, M-STE 6GHD-ST















REF	OEM	
REC13554-0001	119773-42600	6LPA-DTP, -DTZP, -STP, -STZ
	119773-42601	6LP-DT, -DTE, -DTZE, -DTZY, -ST, -STE, -STZE, -STZY, -WDT, -WDTZY



REF	OEM	
CEF500161	119593-42200	6LYM-UTEHD 6LY-ST, -STE, -STM, -STZY, -UT, -UTE, -UTM, UTZY, WST, WSTZY, -WUT, -WUTZY, -UTE, -STE
	119593-42201	



ARANDEAS		WASHERS		RONDELLE		REONDELLES	
ANILLOS DE GOMA		RUBBER O'RINGS		ANELLI IN GOMMA		BAGUE EN CAOUTCHOUC	
REF	OEM						
REC24311-000160	24311-000160	1	1GM, L, Y-C 2GM20, F, F-YEU, -YEU 2GMLP 3GM30, F, F-YEU 3HM35 3JH25A 3JH2L 3JH3E-YEU-E 3YM20 3YM27A 3YM30, AE	4CH-DT 4JH3, ZA, CE, -TCE, -TE, -DTE, -HTE 4LHA-DTE, -DTP, -DTZE, -DTZP, -HTE, -HTP, -HTZE, -STE, -HTZP, -STP, -STZE, -STZP 6LY2-STE 6LY2A-STP 6LYA2-UTP 6LYA-STE, -STP, -UTE			
REC24311-000120	24311-000120	1	1GM, L, Y-C 1GM10 2GM20, F, F-YEU, -YEU 2GMLP 3GM30, F, F-YEU 3HM35	4LHA-DTE, -DTP, -DTZE, -DTZP, -HTE, -HTP, -HTZE, -STE, -HTZP, -STP, -STZE, -STZP 6LY2-STE 6LY2A-STP 6LYA2-UTP 6LYA-STE, -STP, -UTE			
REC24311-000700	24311-000700	1	1GM, L, Y-C 1GM10 2GM20, F, F-YEU, -YEU 2GMLP 3GM30, F, F-YEU 3HM35	4LHA-DTE, -DTP, -DTZE, -DTZP, -HTE, -HTP, -HTZE, -STE, -HTZP, -STP, -STZE, -STZP 6LY2-STE 6LY2A-STP 6LYA2-UTP 6LYA-STE, -STP, -UTE			
REC24341-000240	24341-000240	1	1GM 2GM 3JH 4JH 4JL 6LY				
REC24311-000100	24311-000100	1	1GM, L, Y-C 1GM10 2GM20, F, F-YEU, -YEU 2GMLP 3GM30, F, F-YEU 3HM35				
REC129470-01550	129470-01550	1	3JH2, -TCE, E 3JH3 4JH, -DTE, -HTE, -HTZ, -HTZAE, -TE, -TZ 4JH2-DTE, -HTE, -TE, -UTE 4JH3, ZA, CE, -TCE, -TE, -DTE, -HTE				
REC24321-000350	24321-000350 24325-000350	1	2GM20F-YEU, -YEU 2GMLP 3GM30, F, F-YEU 3HYM35 4CH-DT 6GHA-ET, -ST, -STE 6HGAK-ST1	6GHAM-STE 6GSD-ST 6KHL-ST 6LP-DT, -ST, -DTE, -STE, -DTP, -DTZE, -DTZE1, -DTZEP, -DTZEP1, -DTZY 6LPA-STE, -STP2, -STZP2, -STZP3, -STZE, -STZEP, -STEZP1			
REC121850-51960	121850-51960	1	3JH 4JH				
REC105225-02020	105225-02020	1	2GM20F-YEU, -YEU 2GMLP 3GM30, F, F-YEU				
REC119609-32040	119609-32040	4	3JH25A 3JH40 3JH4E 4JH				
REC24311-000320	24311-000320	2	3JH 4JH				

ARANDELAS DE COBRE	COPPER WASHER	RONDELLE DI RAME	RONDELLES EN CUIVRE
REF	OEM	(mm)	
REC23414-120000	23414-120000	12 x 1.0	1GM, L, Y-C 1GM10 2GM20, F 2GM20F-YEU, -YEU 3GM
REC23414-100000	23414-100000	10 x 1.0	3GM30, F, F-YEU 3HM35 3JH2, -TCE, E, L 3JH25A 3JH3, E-YEU-E
REC23414-250000	23414-250000	25 x 1.0	4JH, -DTE, -HTE, -HTZ, -HTZA, -TE, -TZ 4JH2-DTE, E, -HTE, -TE, -UTE 4JH3, E, CE, ZA, -TCE, -TE, -DTE, -HTE
REC23414-080000	23414-080000	8 x 1.0	4LH-DTE, -STE, -HTE, -TE, -DTZ, -HT, -HTZ, -HTZAY, -ST, -STZ, -STZAY, -UT, -UTZ, -UTZAY, -WST, -WSTZY
			4LHA-DTE, -DTP, -DTZE, -DTZP, -HTE, -HTP, -HTZE, -HTZP, -STE, -STP, AQ-STZE, -STZP 6CX-ETE 6CXM-ETE 6GHS-ET 6GHA-ST, -STE 6GHAK-ST1 6GHAM-STE 6GHD-ST 6LP, A 6LY2, 6LY3, 6LYA 6LY



ARANDELAS SELLO	SEAL WASHER	RONDELA TENUTA	RONDELLE AVEC JOINT
REF	OEM		
REC22190-060002	22190-060002	1	1GM10 1GML, Y-C 2GM20, F, F-YEU, -YEU 2GM20F 3GM30, F, F-YEU 3JH25A
REC22190-080002	22190-080002	1	4JH-HTZAE, -TZ 4JH3, E, CE, ZA, -TCE, -TE SERIE 4LHA
REC22190-100002	22190-100002	2	3JH 4JH
REC22190-140002	22190-140002	4	
REC22190-240002	22190-240002	10	1GM10 1GML, Y-C 6LY3-ETP, -STP, -UTP
REC22190-120002	22190-120002	2	1GM10 1GML, Y-C 2GM20, F, F-YEU, -YEU 2GM20F 3GM30, F, F-YEU 3HM35 3JH3, E-YEU-E 3YM20 3YM27A 3YM30, AE
REC43400-500450	43400-500450	2	1GM10 1GML, Y-C 2GM20, F, F-YEU, -YEU 2GM20F 3GM30, F, F-YEU 3HM35 3JH3, E-YEU-E 3YM20 3YM27A 3YM30, AE
			4JH-HTZAE 4JH3, ZA, E, -TCE, -TE, CE, -DTE, -HTE 4JHA3CE 4JH-HTE, -TE 4JH4E, AE 4JH5E SERIE 4LHA SERIE 4LH SERIE 6LP SERIE 6LPA
			4JH-HTZAE 4JH3, ZA, CE, E, -TCE, -TE, CE, -DTE, -HTE, -HTE, -TE 4JH4E, AE 4JH5E SERIE 4LHA SERIE 4LH, SERIE 6LP SERIE 6LPA









RETENES CIGÜEÑAL	CRANKSHAFT SEAL	PARAOLIO ALBERO MOTORE	JOINTS VILEBREQUIN
------------------	-----------------	------------------------	--------------------

RETENES DELANTEROS	FRONT SEAL	PARAOLIO ANTERIORE	JOINT DAVANT
--------------------	------------	--------------------	--------------

REF	OEM			
REC121450-01801	121450-01801	1GM10 1GML, Y-C 2GM20, F, F-YEU, -YEU 2GMLP 2GMSZK 3GM30, F, F-YEU 3HM, F 3HM35		
REC129795-01800	129795-01800	3JH2, -TCE 3JH25A 3JH2E, L 3JH3, E-YEU-E 3JH4E	4JH, -DTE, -HTE, -HTZ, -HTZAE, -TE, -TZ 4JH2-DTE, -HTE, -TE, -UTE, E 4JH3-DTE, -HTEM, -TE 4JH4AE, E 4JHE	
REC121850-01800	121850-01800	4LH-DTE, -DTZ, -HT, -HTE, -HTZ, -HTZAY, -ST, -STE, -STZ, -STZAY, -TE, -UT, -UTZ, -UTZAY, -WST, -WSTZY 4LHA-DTE, -DTP, -DTZE, -DTZP, -HTE, -HTP, -HTZE, -HTZP, -STE, -STP, -STZE, -STZP	6LY-ST, -STE, -STM, -STZY, -UT, -UTE, -UTM, -UTZY 6LY3-ETP, -STP, -UTP 6LYM-STE, -UTE	
REC119770-90090	119770-90090	6LP-DT, -DTE, -DTZE, -DTZY, -ST, -STE, -STZE, -STZY, -WDT, -WDTZY 6LPA-DTP, -DTZP, -STP, -STZ		
REC119595-01800	119595-01800	6LY-WSY, -WSTZY, -WUT, -WUTZY 6LY2-ST, -STE, -STP, -STVY, -WDT, -WDTZY, -WST, A-STE, A-STP, A-UTP, M-WDT, M-WST 6LYA-STE, -STP, -UTE 6LYM-UTEHD		

RETENES TRASEROS	REAR SEAL	PARAOLIO POSTERIORE	JOINT ARRIÈRE
------------------	-----------	---------------------	---------------

REF	OEM			
REC124085-02220	124085-02220	1GM, L, Y-C 1GM10 2GM20, -YEU, F, F-YEU 2GMLP 2GMSZK 3GM30, F, F-YEU 3HM35		
REC124411-01780	124411-01780	4LH-DTE, -DTZ, -HT, -HTE, -HTZ, -HTZAY, -ST, -STE, -STZ, -STZAY, -TE, -UT, -UTZ, -UTZAY, -WST, -WSTZY 4LHA-DTE, -DTP, -DTZE, -DTZP, -HTE, -HTP, -HTZE, -HTZP, -STE, -STP, -STZE, -STZP 6LY-ST, -STE, -STM, -STZY, -UT, -UTE, -UTM, -UTZY, -WST, -WSTZY, -WUT, -WUTZY	6LY2-ST, -STE, -STP, -STVY, -WDTZY, -WST 6LY2A-STE, -STP, -UTP 6LY2M-WDT, -WST 6LY3-ETP, -STP, -UTP 6LYA-STE, -STP, -UTE 6LYM-STE, -UTE, -UTEHD	
REC123672-01782	123672-01782	3JH2, -TCE, E, L 3JH25A 3JH3, E-YEU-E 3JH4E 3JH5AE, E 3YM20 3YM27A 3YM30, AE	4JH, -DTE, -HTE, -HTZ, -HTZAE, -TE, -TZ 4JH2-DTE, -HTE, -TE, -UTE, E 4JH3-HTE, -TE 4JH4AE, E 4JH5E 4JHE 4CH-DT 6CX-ETE, -GT 6CXM-ETE	
REC119770-90290	119770-90290	6LP-DT, -DTE, -DTZE, -DTZY, -ST, -STE, -STZE, -STZY, -WDT, -WDTZY 6LPA-DTP, -DTZP, -STP, -STZ		

## KITS DE PISTONES

## PISTONS SET

## KIT PISTONI



## KIT PISTONS



## KITS AROS DE PISTONES

## PISTONS RINGS SET

## KIT FASCE PISTONI

## KITS SEGMENT DE PISTONS



REF	OEM		
	72100-22500	1GM 1GML 2GMSZK	

REF	OEM		
REC721575-22500	721575-22500 705311-22500	1GM10 2GM20, -YEU, F, F-YEU 2GMLP 3GM30, F, F-YEU 3HM, F	



REF	OEM		
REC729120-22500	729120-22500	3JH2, -TCE, E, L 3JH25A	

REF	OEM		
REC129005-22500	129005-22500	3JH4E 3JH5AE, E 4JH4AE, E 4JH5E	



REF	OEM		
REC127610-22501	127610-22501	4CH-DT 4JH2-HTE, -TE, -UTE	

REF	OEM		
REC719000-22501	719000-22501	4LH-DTE, -HT, -HTE, -HTZ, -HTZAY, -ST, -STE, -STZ, -STZAY, -TE, -UT, -UTZ, -UTZAY 4LHA-DTE, -DTP, -DTZE, -DTZP, -HTE, -HTP, -HTZE, -HTZP, -STE, -STP, -STZE, -STZP	

REF	OEM		
REC129590-22510	129590-22510	4JH, -HTE, -HTZ, -HTZAE, -TE, -TZ, E	

REF	OEM		
REC119593-22351	119593-22351	4LH-DTZ 6LY-ST, -STE, -STM, -STZY, -UT, -UTE, UTM, -UTZY, -WST, -WSTZY, -WUT, -WUTZY 6LYA-STE, -STP, -UTE 6LYM-STE, -UTE, -UTEHD	

REF	OEM		
REC119595-22300	119595-22300	6LY2-ST, -STE, -STP, -STVY, -WDT, -WDTZY, -WST 6LY2A-STE, -STP, -UTP 6LY2M-WDT, -WST	

REF	OEM		
REC704571-22500	704571-22500	YSM12	

REF	OEM		
REC728633-22500	728633-22500	6GHA-ET, -ST, -STE 6GHAK-ST1 6GHAM-STE	

REF	OEM	
REC119770-00250	119770-00250	6LP-DT, -DTE, -DTZE, -DTZY, -ST, -STE, -STZE, -STZY, -WDT, -WDTZY 6LPA-DTP, -DTZP, -STP, -STZ



**KITS COJINETES BANCADA**

**MAIN BEARING KITS**

**KIT BRONZE DI BANCO**

**KITS COUSSINET VILEBREQUIN**

REF	OEM	
REC129150-02800	129150-02800	3JH2, E, L, -TCE 3JH25A 4JH2-DTE, E, -HTE, -TE, -UTE, 4JH-DTE, E, -HTE, -HTZ, -HTZAE, -TE, -TZ



REF	OEM	
REC719000-02800	719000-02800	4LHA-DTE, -DTP, -DTZE, -DTZP, -HTE, -HTP, -HTZE, -HTZP, -STE, -STP, -STZE, -STZP 4LH-STE, -DTZ, -HT, -HTE, -HTZ, -HTZAY, -ST, -STE, -STZ, -STZAY, -TE, -UT, -UTZ, -UTZAY, -WST, -WSTZY



REF	OEM	
REC129690-02800	129690-02800	3JH3 4JH3-DFTE, -HTE, -TE



REF	OEM	
REC719717-02901	719717-02901	3YM20 3YM27A 3YM30, AE



**KITS COJINETES BANCADA CENTRAL**

**MAIN BEARING KITS CENTRAL**

**KIT BRONZE DI BANCO CENTRO**

**KITS COUSSINET VILEBREQUIN CENTRAL**

REF	OEM	
REC121450-02170	121450-02170	3GM30, F, F-YEU



**KITS COJINETES BANCADA DELANTEROS**

**MAIN BEARING KITS FRONT**

**KIT BRONZE DI BANCO ANTERIORE**

**KITS COUSSINET VILEBREQUIN AVANT**

REF	OEM	
REC121450-02100	121450-02100	1GM, L, Y-C 1GM10 2GM20, F, F-YEU, -YEU 2GMLP 2GMSZK 3GM30, F, 30F-YEU



REF	OEM	
REC129001-02931	129001-02931	3JH3E-YEU-E 3JH4E 3JH5AE, E 4JH4E, AE 4JH5E



REF	OEM	
REC119770-02031	119770-02031	6LPA-DTP, -DTZP, -STP, -STZ 6LP-DT, -DTE, -STZE, -DTZY, -ST, -STE, -STZE, -STZY, -WDT, WDTZY



**KITS COJINETES BANCADA TRASERO**

**MAIN BEARING KITS REAR**

**KIT BRONZE DI BANCO POSTERIORE**

**KITS COUSSINET VILEBREQUIN ARRIÈRE**

REF	OEM	
REC121450-02110	121450-02110	1GM, L, Y-C 1GM10 2GM20, F, F-YEU, -YEU 2GMLP 2GMSZK 3GM30, F, 30F-YEU



**KITS COJINETES BIELA**

**CONNECTING ROD BEARING KITS**

**KIT BRONZINE DI BIELLA**

**KITS ROULEMENT DE BIELLE**

REF	OEM	
REC705311-23600	705311-23600	1GM, L, Y-C 1GM10 2GM20, F, F-YEU, -YEU 2GMLP 2GMSZK 3GM30, F, 30F-YEU



REF	OEM	
REC129150-23601	129150-23601	3JH2, E, L, -TCE 3JH25A 3JH3, E-YEU-E 3JH4E 3JH5AE, E 4JH, -DTE, E, -HTE, -HTZ, -HTZAE, -TE, -TZ 4JH2-DTE, E, -HTE, -TE, -UTE 4JH3-DTE, -HTE, -TE 4JH4E, AE 4JH5E





REF	OEM	
REC719174-23601	719174-23601	4LHA-DTE, -DTP, -DTZE, -DTZP, -HTE, -HTP, -HTZE, -HTZP, -STE, -STP, -STZE, -STZP 4LH-DTE, -DTZ, -HT, -HTE, -HTZ, HTZAY, -ST, -STE, -STZ, -STZAY, -TE, -UT, -UTZ, -UTZAY, -WST, -WSTZY





REF	OEM	
REC719593-23601	719593-23601	6LYA-STE, -STP, -UTE 6LYM-UTE, -STE, -UTEHD 6LY-ST, -STE, -STM, -STZY, -UT, -UTE, -UTM, UTZY, -WST, -WSTZY, -WUT, -WUTZY



REF	OEM	
REC128625-23361	128625-23361	6GHA-ET, -ST, -STE 6GHAK-ST1 6GHAM-STE 6GHD-ST



REF	OEM	
REC719595-23600	719595-23600	6LY2-ST, -STE, -STVY, -STP, -WDT, -WDTZY, -WST 6LY2A-ST, -STP, -UTP 6LY2M-WDT, -WST 6LY3-ETP, -STP, -UTP



REF	OEM	
MARK 2	REC119770-00260	119770-00260
MARK 3	REC119770-01010	119770-01010
MARK 4	REC119770-01020	119770-01020
MARK 5	REC119770-01030	119770-01030
MARK 6	REC119770-01040	119770-01040

6LPA-DTP, -DTZP, -STP, -STZ  
6LP-DT, -DTE, -DTZE, -DTZY, -ST, -STE, -STZE, -STZY, -WDT, -WDTZY





### KITS COJINETES AXIALES

### AXIAL BEARING KIT

### KIT BRONZINE ASSIAL

### KITS ROULEMENT AXIAL

REF	OEM	
REC121450-02160	121450-02160	2GM20, F, F-YEU, -YEU 2GMLP 2GMSZK 3GM30, F, F-YEU







REF	OEM	
REC119717-02930	119717-02930	3YM20 3YM27A 3YM30, AE





REF	OEM	
REC129150-02931	129150-02931	3JH2, E, L, -TCE 3JH25A 3JH3, E-YEU-E 3JH4E 3JH5AE, E 4JH, -DTE, E, -HTE, -HTZ, -HTZAE, -TE, -TZ 4JH2-DTE, E, -HTE, -TE, -UTE 4JH3-DTE, -HTE, -TE 4JH4E, AE 4JH5E



REF	OEM		
REC719000-02930	719000-02930	4LHA-DTE, -DSTP, -DTZE, -DTZP, -HTE, -HTP, -HTZE, -HTZP, -STE, -STP, -STZE, -STZP 4LH-DTE, -DTZ, -HT, -HTE, -HTZ, HTZAY, -ST, -STE, -STZ, -STZAY, -TE, -UT, -UTZ, -UTZAY, -WST, -WSTZY	

REF	OEM		
REC719593-02590	719593-02590	6LY2-ST, -STE, -STP, -STVY, -WDT, -WST, -WDTZY 6LY2A-STE, -STP, -UTP 6LY2M-WDT 3-UTP 6LYA-STE, -STP, -UTE 6LYM-UTE, -STE, -UTEHD 6LY-ST, -STE, -STM, -STZY, -UT, -UTE, -UTM, UTZY, -WST, -WSTZY, -WUT, -WUTZY	

REF	OEM		
REC119770-00130	119770-00130	6LPA-DTP, -DTZP, -STP, -STZ 6LP-DT, -DTE, -DTZE, -DTZY, -ST, -STE, -STZE, -STZY, -WDT, -WDTZY	

VÁLVULAS	VALVE	VALVOLA	SOUPAPE
RETENES	VALVE STEM SEALS	PARAOILIO VALVOLE	JOINTS D'HUILE

REF	OEM	
REC124950-11340	124950-11340	1GM, L, Y-C 1GM10 2GM20, F, F-YEU, -YEU 2GMLP 2GMSZ 3GM30, F, F-YEU 3HM, F 3HM35



REF	OEM	
REC121850-11150	121850-11150	6GHA-ET, -ST, -STE 6GHAK-ST1 6GHAM-STE 6GHD-ST



REF	OEM	
REC127616-11280	127616-11280	4CH-DT 6CX-ETE, -GT, M-ETE



REF	OEM	
REC119770-91030	119770-91030	6LPA-DTP, -DTZP 6LP-DT, -DTE, -DTZE, -DTZY, -ST, -STE, -STZE, -STZY, -WDT, -WDTZY



RETENES VÁLVULAS ADMISIÓN Y ESCAPE	INTAKE & EXHAUST SEAL VALVES	PARAOLIO VALVOLE ASPIRAZIONE E SCARICO	JOINT D'HUILE, ADMISSION ET ÉCHAPPEMENT
	ADMISIÓN INTAKE ASPIRAZIONE ADMISSION	OEM	ESCAPE EXHAUST SCARICO ÉCHAPPEMENT
			OEM
4LHA-HTP, -HTZE, -HTZP, -STE, -STP, -STZE, -STZP 4LH-DTE, -DTZ, -HT, -HTE, -HTZ, -HTZAY, -ST, -STE, -STZ, -STZAY, -TE 6LY2-ST, -STE, -STVY, -STP, -WDT, -WDTZY, -WST 6LY2A-STE, -UTP 6LY2M-WDT, -WST 6LYA-STE, -STP, -UTE 6LYM-UTE, -STE, -UTEHD 6LY-ST, , -STE, -STM, -STZY, -UT, -UTE, -UTM, UTZY, -WST, -WSTZY, -WUT, -WUTZY	REC121850-11150	121850-11150	REC119171-11150 119171-11150
3YM20 3YM27A 3YM30, AE	REC119717-11340	119717-11340	REC119717-11350 119717-11350
3JH2, L, E, -TCE 3JH25A 3JH3, E-YEU-E 3JH4E 3JH5AE, E 4JH2-DTE, E, -HTE, -TE, -UTE 4JH3-DTE, -HTE, -TE 4JH4E, AE 4JH5E 4JHE, -HTE, -HTZ, -HTZAE, -TE 6LY3-ETP, -STP, -UTP	REC124460-11340	124460-11340	REC121400-11340 121400-11340



VÁLVULAS ADMISIÓN Y ESCAPE	INTAKE & EXHAUST VALVES	VALVOLE ASPIRAZIONE E SCARICO	SOUPAPES ADMISSION ET ÉCHAPPEMENT
	ADMISIÓN INTAKE ASPIRAZIONE ADMISSION	OEM	ESCAPE EXHAUST SCARICO ÉCHAPPEMENT
			OEM
4LH-DTE, -DTZ, -HTE, -HTZ, -HTZAY, -ST, -STE, -STZ, -STZAY, -TE, -UT, -UTZ, -UTZAY, -WST, -WSTZY 4LHA-DTE, -DTP, -DTZE, -STZP, -STE, -STP, -STZE, -STZP 6LY-ST, -STE, -STM, -STZY, -UT, -UTE, -UTM, -UTZY, -WST, -WSTZY, -WUT, -WUTZY 6LY2-ST, -STE, -STP, -STVY, -WDT, -WDTZY, -WST, -STE, -STP 6LY2A-UTP 6LY2M-WDT, -WST 6LYA-STE, -STP, UTE 6LYM-STE, -UTE, -UTEHD 6LP-DT, -DTE, -DTZE, -DTZY, -ST, -STE, -STZE, -STZY, -WDT, -WDTZY 6LPA-DT, -DTZP 4LHA-HTE, -HTP, -HTZE, -HTZP 6GHA-ET, -ST, -STE 6GHAK-ST1 6GHAM-STE 6GHD-ST 3JH5AE, E 4JH4AE 4JH5 3JH2, -TCE, E, L 3JH25A 3JH3 4JH-DTE, -HTE, E 4JH2-DTE, -HTE, -TE, -UTE, E 4JH3-TE 4JH, -HTZ, -HTZAE, -TE, TZ 4JH3-DTE, -HTE 3HM, F 3HM35 1GM, L, Y-C 1GM10 2GM20, F, F-YEU, -YEU 2GM1P 2GMSZK 3GM30, F, 30F-YEU YSM12 YSB12 YSE12 4LH-HT, -HTZ, -HTZAY 4LHA-HTE, -HTZE, -HTZP	REC119173-11101	119173-11101	REC119593-11110 119593-11110
	REC119770-00480	119770-00480	REC119770-00490 119770-00490
	REC121850-11100	121850-11100	
	REC128619-11100	128619-11100	REC128619-11110 128619-11110
	REC129005-11100	129005-11100	
	REC129100-11100	129100-11100	REC129100-11112 129100-11112
	REC129120-11100	129120-11100	REC129120-11110 129120-11110
	REC104211-11100	104211-11100	REC104211-11110 104211-11110
	REC105225-11100	105225-11100	REC105225-11110 105225-11110
	REC104511-11100	104511-11100	
			REC119171-11110 119171-11110



# SISTEMA DE ESCAPE Y ADMISIÓN EXHAUST & INTAKE SYSTEM

## SISTEMA DI SCARICO E ASPIRAZIONE SYSTEME D'ÉCHAPPEMENT ET D'ADMISSION

CODOS



ELBOWS

GOMITI

COUDES

REF	OEM			PIPA RACORD RACORDO RACORD	
MAR3520		1GM, 1GM10			
		2GM20F, FVE, F-YEU, FC-YEU			
	104214-13531	2GMFYE, FL			
	104214-13521	3GM, F, FY-E, FYE-E, FLE			
	104070-13520	3GMD			
	128370-13600	3HM	REC128370-13201	3/8"	2"
	128990-13520	3GM30, VE, B, C, -YEU, C-YEU, F-YEU, FC-YEU			
	127070-13520	3HM35, C			
		3YM20			
		3YM30, AE			







REF	OEM				
REC129792-13552INOX	129792-13552	4JH-TZ, -TZA, -HTZ, -HTZA, -HTZY, -DTZ, -DTZP, -DTZA, -DTZY, -TZAE, -HTZAE, -TE, -TZ, -TZA, -TZAY, -TZ1, -TZ2	REC129472-13520	1"	3"
	129792-13551				
	129671-13551	4JH2-TE, -HTE, -DTE, -UTE, -ETB, -DTZ			
	129579-13551	4JH3-T, -T1, -TZA, -TZAY, -HTZ1, -HTZA, -HTZY1, -HTZAY			



REF	OEM	
MAR13200	724770-13200	2QM 2QM20







REF	OEM				
MAR13561	129470-13561	3JH2	REC129472-18090	1"	3"
	129470-13560	3JH3, E			
	129670-13560	3JH5E			
	129670-13561	4JH2E, CE, TE, -DTE			
		4JH3, E			
	4JHE				











**CODO ESCAPE INOX      SS ELBOW      GOMITO SCARICO INOSS      COUDE D'ÉCHAPPEMENT INOX**

REF	OEM				
REC119181-13500INOX	119181-13500	4LH-STE	REC119171-13510	1-1/4"	4"







REF	OEM			
REC119173-13501INOX	119173-13501	4LHA-HTE (150 HP), -DTE (190 HP), -STE (230 HP), -HTP/-STP/-ST2P (240 HP)	1-1/4"	3-1/2"







REF	OEM			
MAR119773-13501INOX SED3092500	119773-13501 119773-13500	4LH-STE, -YA, -HTP, -DTP, -STP 4LHA-THE, -DTE, -HTP, -DTP 6LP-DTE, -STE 6LPA-STP, -DTP 8LV	1-1/4" BSPT THREAD INLET	4"







REF	OEM				
MAR119171-13490INOX	119171-13490	4LH SERIES/-HTZ, -HTZAY, -HTE, -TE	REC119171-13510	1-1/4"	3-1/2"







REF	OEM				
MAR119171-13530INOX	119171-13530	4LH SERIES/ -DTE, -HTE, -TE, -DTZ	REC119171-13510	1-1/4"	3-1/2"







REF	OEM				
MAR119174-13501INOX	119174-13501	4LH SERIES/ -UTZ, UTZAY, STZ, STZAY, STE, WST, WSTZAY	REC119171-13510	1-1/4"	4"



REF	OEM				
MAR119574-13530INOX	119574-13530	6LY SERIES/ 3-ETP, A-UTE(P), A-STE(P), A-STP, 2A-STP, 2-STE		1-1/2"	5"







new

REF	OEM				
MAR119588-13501INOX	119588-13501	6LY SERIES/ -UTM, UTZY, WUTZY, -STE, M-UTE, M-STE		1-1/2"	5"







new

REF	OEM				
MAR128370-13550INOX	128370-13550	3GM30 SERIES/ VE, B,C/ 3HM35, C			2"







new

REF	OEM				
MAR128890-13530INOX	128890-13530	2YM15/ 2GM20F, FC-YEU/3YM20, 30, 30AE, 3GM- 30FC-YEU	REC128370-13201	7/8"	2"







new

REF	OEM				
MAR129470-13550INOX	129470-13550	3JH2BE, CE, E/ 4JH2CE	REC129472-18090	1"	2"



new

REF	OEM				
MAR129671-13552INOX	129671-13552	4JH4-HTE1,-HTE / 4JH3-HTE,-DTE / 4JF57 / 4JH80 / 4JH110	REC129472-13520	1"	3"



















new

# UNIDADES DE TRANSMISIÓN TRANSMISSION UNIT

# UNITÀ DI TRASMISSIONE EMBASES ET PIÈCES

RECMAR®





ÁNODO		ANODE		ANODI		ANODE	
REF	OEM			REF	OEM		
ZN REC27210-200300	27210-200300	2GM20, F, F-YEU, -YEU 2GM1P, SZK 3GM30, F, F-YEU 3HM, F 3HM35 6GHA-ET, -ST, -STE, K-ST1, M-STE 6GHD-ST 6KHL-ST		ZN REC27210-200550	27210-200550 177301-549000	6LYM-UTEHD 6LY-ST, -STE, -STM, -STZY, -UT, -UTE, -UTM, -UTZY, -WST, -WSTZY, -WUT, -WUTZY SD20, 25, 30, 31 4LH-STE	
REF	OEM			ZN REC104211-41300	104211-41300	YSE8 8FS YSE10 12PSP	
ZN REC27210-200200	27210-200200	1GM, L, Y-C 1GM10 6GHA-ET, -ST, -STE, K-ST1, M-STE 6GHD-S 6KHL-ST		AL REC104211-41300AL			
REF	OEM			REF	OEM		
ZN REC27210-200370	27210-200370	6GHA-ET, -ST, -STE, K-ST1, M-STE 6GHD-ST 6CX-GT		ZN REC27210-300400	27200-300400	6GHA-ET, -ST, -STE, K-ST1, M-STE 6GHD-ST 6KHL-ST	
REF	OEM			ZN REC27210-01302	70-85 HP		
ZN REC27210-01302				AL REC27210-01302AL			
REF	OEM			REF	OEM		
ZN REC27200-400400	27200-400400	6LA-DT, -DTE, -ST 6LAK-ST, -ST1 6LAH-ST, -STE 6LAA, E, -VTE 8LLA-DTE		ZN REC104211-41300	104211-41300	SEALDRIVE	
REF	OEM			ZN REC196630-02670	196630-02670	D27 D36	
ZN REC196630-02670				AL REC196630-02670AL			

TUERCA HÉLICE	BLADE NUT	DADO ELICA	ÉCROU HÉLICE
---------------	-----------	------------	--------------

REF	OEM		
ZN REC196350-09910	196350-09910	ZT350 ZT370	
AL REC196350-09910AL			

YANMAR

RECAMBIOS  
MARINOS

COLA VELERO			SAILBOAT GEARCASE			PIEDE VELA			EMBASE DE VELIER		
REF	OEM		REF	OEM		REF	OEM		REF	OEM	
AL REC196450-02501AL	196440-02660	SD20	ZN REC196350-02570	196350-02570		ZN REC196350-02570AL		ZT350	ZN REC196350-02550	196350-02550	ZT370
ZN REC196450-02501	196450-02501	SD25	AL REC196350-02570AL			AL REC196350-02550AL					
AL REC196440-02690AL		SD30									
ZN REC196440-02690	196440-02690	SD31									
		SD40									
		SD50									
		SD60									



REC196450-02501AL  
REC196450-02501



REC196440-02690AL  
REC196440-02690



REC196350-02570  
REC196350-02570AL







REC196350-02550  
REC196350-02550AL



TIMÓN			RUDDER			TIMONE			DERIVE		
REF	OEM		REF	OEM		REF	OEM		REF	OEM	
ZN REC196640-02680	196640-62680	B63									
AL REC196640-02680AL		D36A									
		D27A									



ALETA CABITACIÓN			CABITATION FLAP			FLAP CABINAZIONE			PLAQUE STERNDRIVE		
REF	OEM		REF	OEM		REF	OEM		REF	OEM	
ZN REC196350-02350	196350-02350	ZT350									
AL REC196350-02350AL		ZT370									



KITS DE ÁNODOS			ANODES KIT			KIT ANODI			KIT ANODES		
REF			REF			REF			REF		
ZN RECKITYZT350-ZT370ZN			ZN RECKITYZT350-ZT370ZN			ZN RECKITYZT350-ZT370ZN			ZN RECKITYZT350-ZT370ZN		
AL RECKITYZT350-ZT370AL			AL RECKITYZT350-ZT370AL			AL RECKITYZT350-ZT370AL			AL RECKITYZT350-ZT370AL		
MG RECKITYZT350-ZT370M			MG RECKITYZT350-ZT370M			MG RECKITYZT350-ZT370M			MG RECKITYZT350-ZT370M		

KIT		OEM		
REC119574-18790Z		119574-18790		4LHA-STZP
	REC119574-18790	177301-54900		4LH-DTE, -DTZ, -HT, -HTE, -HTZ, -HTZAY, -ST, -STE, -STZ, -STZAY, -TE, -UT, -UTZ, -UTZAY
			REC119574-18790TP	
REC1195574-44150Z		119574-44150		4LHA-DTE, -DTP, -DTZE, -DTZP, -HTE, -HTP, -HTZE, -HTZP, -STE, -STP, -STZE
	REC27210-200370	27210-200370		
			REC27210-200370TP	







**ÁNODO**



**ANODE**

**ANODI**

**ANODE**

REF	OEM	 (kg)	
ZN TEN01301	27210-200300		2GM20, F, F-YEU, -YEU 2GMLP, SZK 3GM30, F, F-YEU 3HM, F 3HM35 6GHA-ET, -ST, -STE, K-ST1, M-STE 6GHD-ST 6KHL-ST



REF	OEM	 (kg)	
ZN TEN01306	27210-200550 177301-549000		6LYM-UTEHD 6LY-ST, -STE, -STM, -STZY, -UT, -UTE, -UTM, -UTZY, -WST, -WSTZY, -WUT, -WUTZY SD20, 25, 30, 31 4LH-STE





REF	OEM	 (kg)	
ZN TEN01302			70-85 HP





REF	OEM	 (kg)	
ZN TEN01300	104211-41300		YSE8 8FS YSE10 12PSP





REF	OEM	 (kg)	
ZN TEN01303	27210-200200		1GM, L, Y-C 1GM10 6GHA-ET, -ST, -STE, K-STI, M-STE 6GHD-S 6KHL-ST





REF	OEM	 (kg)	
ZN TEN01310	27200-400400		6LA-DT, -DTE, -ST 6LAK-ST, -ST1 6LAH-ST, -STE 6LAA, E, -VTE 8LLA-DTE





REF	OEM	 (kg)	
ZN TEN01311	27200-300400		6GHA-ET, -ST, -STE, K-ST1, M-STE 6GHD-ST 6KHL-ST





REF	OEM	 (kg)	
ZN TEN01308	104211-41300		SEALDRIVE





REF	OEM	 (kg)	
ZN TEN01312	27210-200370		6GHA-ET, -ST, -STE, K-ST1, M-STE 6GHD-ST 6CX-GT





REF	OEM	 (kg)	
ZN TEN01304	196630-02670		D27 D36



**TRIM**

REF	OEM	 (kg)	
ZN TEN01393-1	196350-07360		ZT350 ZT370



COLA VELERO		SAILBOAT GEARCASE		PIEDE VELA		EMBASE DE VELIER	
REF	OEM	 (kg)		REF	OEM	 (kg)	
ZN TEN01305/1	196440-02660 196450-02501		SD20 SD25 SD30 SD31 SD40 SD50 SD60	ZN TEN01391-1	196350-02570		ZT350 ZT370
ZN TENPLAC-1	196440-02690			ZN TEN01390-1	196350-02550		
							
TEN01305/1		TENPLAC-1		TEN01391-1		TEN01390-1	

TUERCA HÉLICE		BLADE NUT		DADO ELICA		ÉCROU HÉLICE	
REF	OEM	 (kg)					
ZN TEN01392-1	196350-09910		ZT350 ZT370				

  



TIMÓN		RUDDER		TIMONE		DERIVE	
REF	OEM	 (kg)					
ZN TEN01319	196640-62680		B63 D36A D27A				

ALETA CABITACIÓN		CABITATION FLAP		FLAP CABINAZIONE		PLAQUE STERNDRIVE	
REF	OEM	 (kg)					
ZN TEN01394-1	196350-02350		ZT350 ZT370				



  



KITS DE ÁNODOS		ANODES KIT		KIT ANODI		KIT ANODES	
REF	OEM	 (kg)					
ZN TENKITYANMARSTD		0,94	ZT350-ZT370			new	

KIT		OEM	 (kg)	
TEN01317T		119574-18790		4LHA-STZP
	TEN01317	177301-54900		4LH-DTE, -DTZ, -HT, -HTE, -HTZ, -HTZAY, -ST, -STE, -STZ, -STZAY, -TE, -UT, -UTZ, -UTZAY
			TEN01317TP	
TEN01316T		119574-44150		
TEN01318T				
	TEN01316	27210-200370		4LHA-DTE, -DTP, -DTZE, -DTZP, -HTE, -HTP, -HTZE, -HTZP, -STE, -STP, -STZE
	TEN01318			
			TEN01316TP	
			TEN01318TP	





**ÁNODO ANODE ANODI ANODE**

REF	OEM			
ZN CMC272100-20030	27210-200300		2GM20, F, F-YEU, -YEU 2GM1P, SZK 3GM30, F, F-YEU 3HM, F	
			3HM35 6GHA-ET, -ST, -STE, K-ST1, M-STE 6GHD-ST 6KHL-ST	



REF	OEM			
ZN CMC10421141-300	104211-41300		YSE8 8FS YSE10 12PSP	

**COLA VELERO SAILBOAT GEARCASE PIEDE VELA EMBASE DE VELIER**

REF	OEM		
ZN CM19642002652Z	196420-02652 196450-02492		SD20 SD25 SD30 SD31 SD40 SD50 SD60
AL CM19642002652A			

REF	OEM			
ZN CM19644002660KITZ	196440-02660 196450-02501		SD20 SD25 SD30 SD31 SD40 SD50 SD60	
AL CM19644002660KITA				

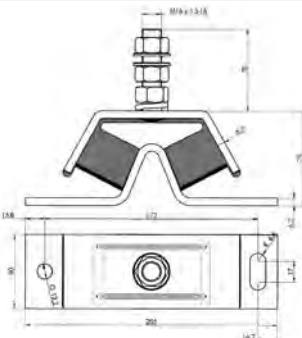

**SOPORTE MOTOR ENGINE MOUNT SCREW SUPPORTI MOTORE SUPPORT MOTEUR**

REF	OEM			
GS38120	124770-12540	40 Kg / 88 lb		





REF	OEM			
GS38107	128270-08341	75 Kg 165 lb		2GM20, VE, B, F, FVE 3GM30, B, C, F



REF	OEM			
GS38108	124772-08341	100 Kg 220 lb		2GM20, VE, B, F, FVE 3GM30, VE, B, C, F, FVE 3JH2CE, -TCE, E, BE, S-TBE, G-TBE, S-TE, G-TE 1GM10V 2GM20V, FV 3GM30V, FV 3JHM35 3HM35F



REF	OEM			
GS38121	121370-08351	150 Kg 330 lb		3JH2CE, -TCE, E, BE, S-TBE, G-TBE, S-TE, G-TE 4JH-DTE, -HTE, E, -TE 4JH2E, -TE, -HTE, -DTE, -UTE, -UTB 3JH2CE, -TCE, E, BE, S-TBE, G-TBE, S-TE, G-TE



**YANMAR**

**RECAMBIOS MARINOS**

KITS RETENES  
TRANSMISIÓN

TRANSMISION SEAL KIT

KIT GUARNIZIONE  
TRANSMISSIONE

KIT JOINTS D'EMBASE

GUÍA KITS DE RETENES  
TRASMISIÓN

TRANSMISION SEAL KIT  
GUIDE

GUIDA KITS GUARNIZIONE  
TRANSMISSIONE

GUIDE KIT JOINTS  
D'EMBASE

KIT	REF					UN.
RECS20	196313-02591	RETÉN	OIL SEAL	TENUTA	JOINT D'HUILE	2
	24321-000950	TÓRICA	O-RING	FASCIA TONDA	JOINT TORIQUE	2
	24341-000125	JUNTA	GASKET	GUARNIZIONE	JOINT	1
RECS25	196313-02591	RETÉN	OIL SEAL	TENUTA	JOINT D'HUILE	2
	196420-12240	TÓRICA	O-RING	FASCIA TONDA	JOINT TORIQUE	2
	24341-000125	JUNTA	GASKET	GUARNIZIONE	JOINT	1
RECS40	196440-02871	RETÉN	OIL SEAL	TENUTA	JOINT D'HUILE	2
	24321-000950	TÓRICA	O-RING	FASCIA TONDA	JOINT TORIQUE	2
	24341-000125	JUNTA	GASKET	GUARNIZIONE	JOINT	1

SD20

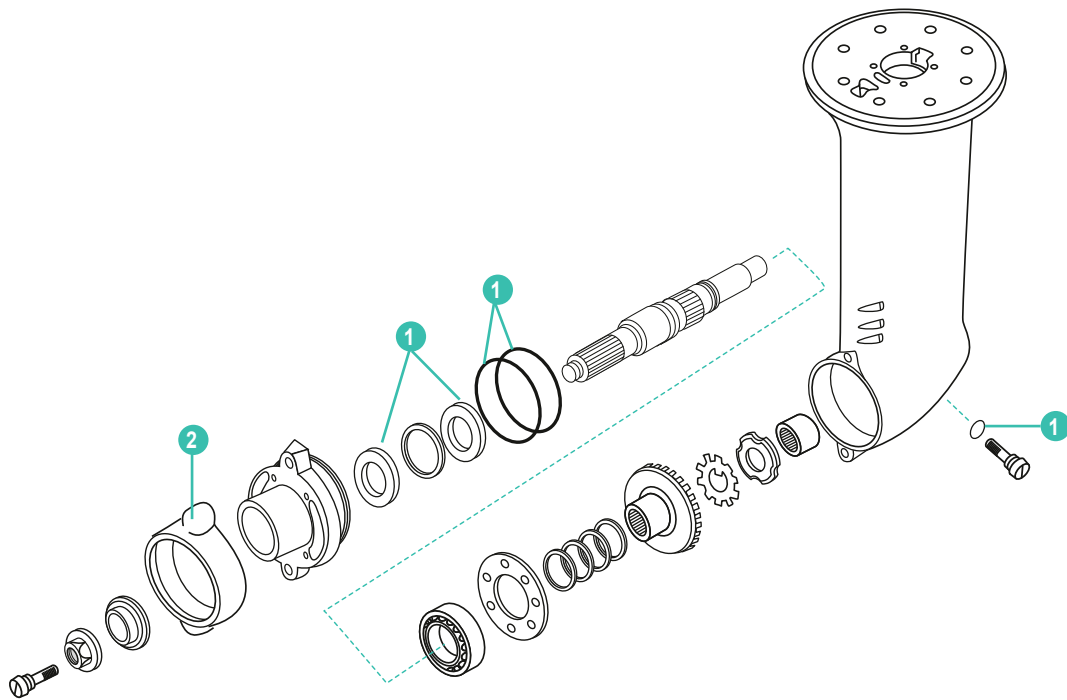

	REF	OEM				
1	RECS20		KIT	KIT	KIT	KIT
2	TEN01305	196420-02640	ÁNODO	ANODE	ANODO	ANODE



SD25

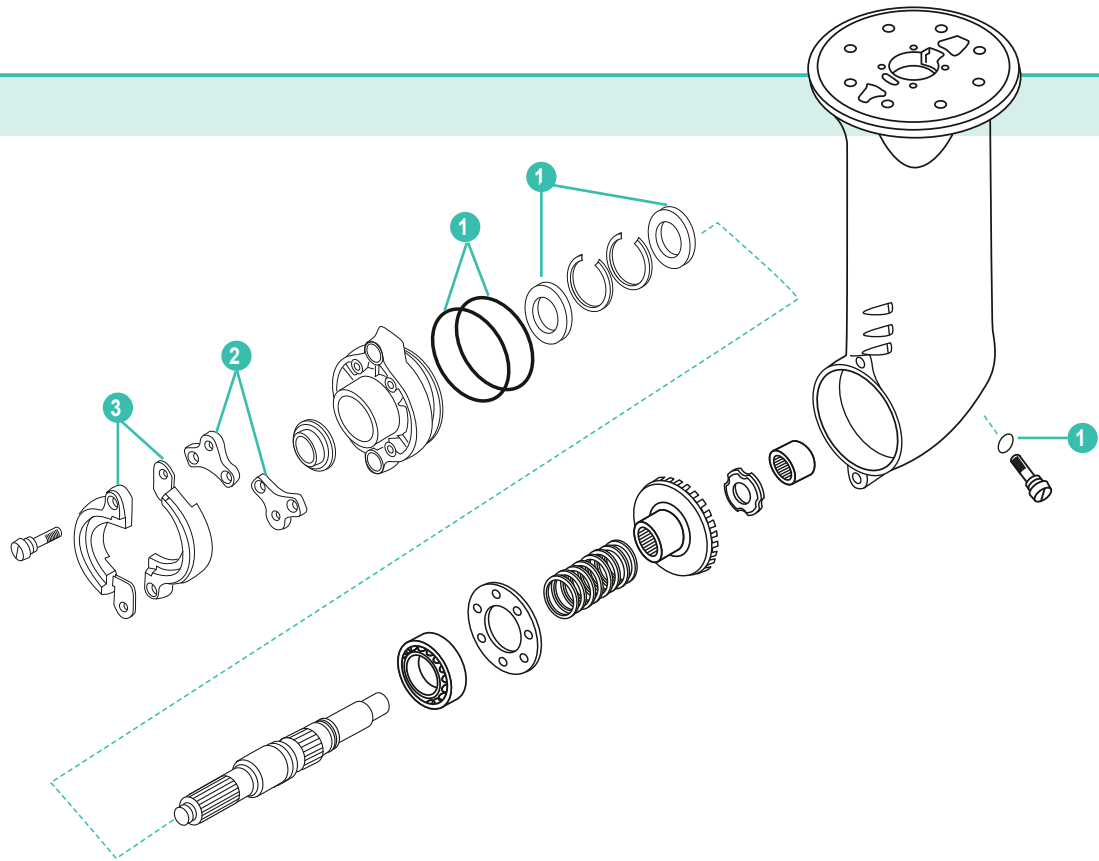

REF	OEM				
1 RECSD25		KIT	KIT	KIT	KIT
2 TEN01305/1	126450-02501	ÁNODO	ANODE	ANODO	ANODE
3 TENPLAC-1	196440-02690	ÁNODO	ANODE	ANODO	ANODE

SD40/50

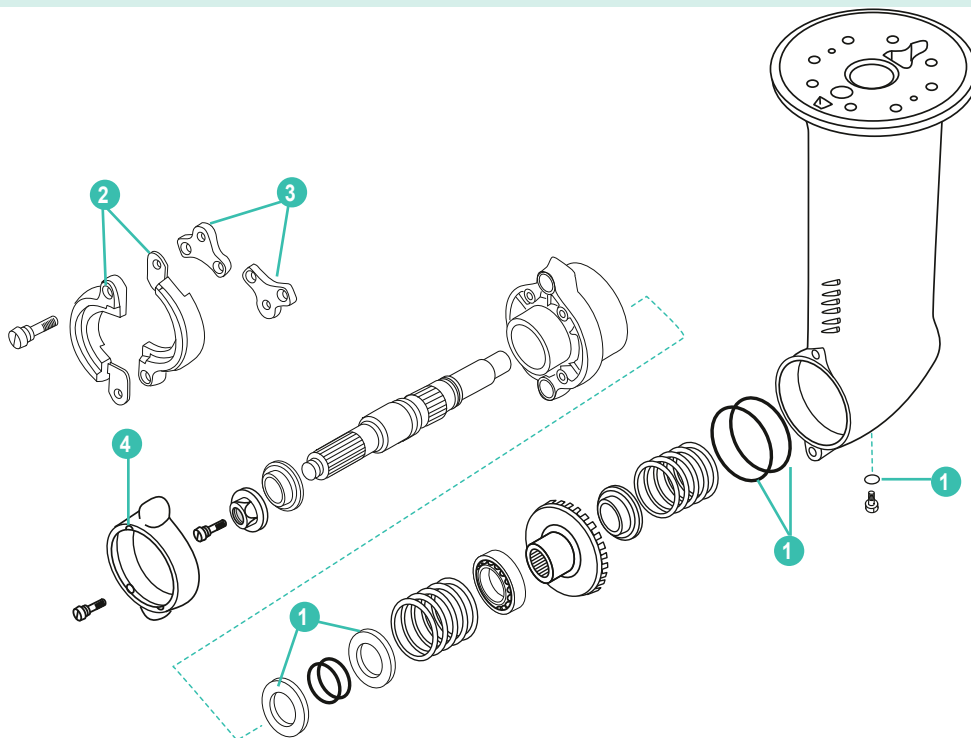

REF	OEM				
1 RECSD40		KIT	KIT	KIT	KIT
2 TEN01305/1	126450-02600	ÁNODO	ANODE	ANODO	ANODE
3 TENPLAC-1	196440-02690	ÁNODO	ANODE	ANODO	ANODE
4 TEN01305	196420-02652	ÁNODO	ANODE	ANODO	ANODE

# SISTEMA DE PROPULSIÓN PROPULSION SYSTEM

# SISTEMA DI PROPULSIONE SYSTEME DE PROPULSION

HÉLICES ALUMINIO E  
INOXIDABLE  
DE 3 Y 4 PALAS

3 & 4 BLADE  
ALUMINIUM & SS  
PROPELLERS

ELICHE ALLUMINIO E  
INOX DA 3 E 4 PALE

HELICE ALUMINIUM ET  
INOX 3 ET 4 PALES

CÓDIGO DE REFERENCIAS

PART NO. CODING SYSTEM

SISTEMA DI CODICE

CODAGE DES REFERENCES

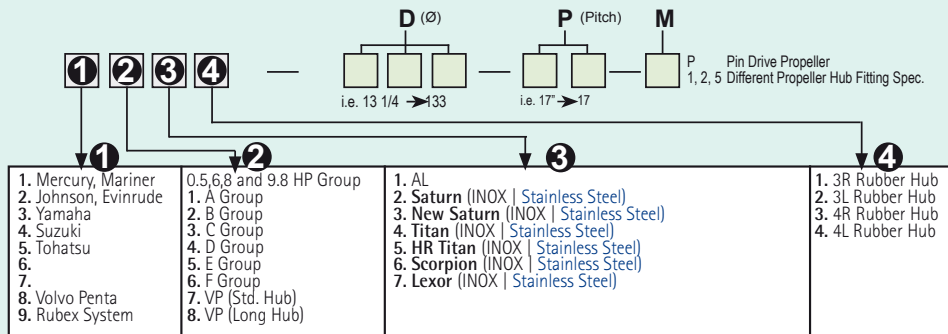

SOLAS

## AMITA 3

SOLAS

Hélice de aluminio con núcleo de goma de gran resistencia.

Aluminum propeller with heavy duty rubber hub.

Eliche di alluminio con mozzi in gomma ad alta resistenza.

Hélice en aluminium avec moyeu en caoutchouc



## AMITA 3 PLUS

SOLAS

Diseño de pala grande para un área más grande.

High camber blade and large blade area design.

Con un'area più ampia nelle pale.

Conception d'une grande pale pour une plus grande surface.



	CUBO ESTÁNDAR STANDAR HUB MOZZO STANDARD NOYAU STANDARD	B	D	P	R	AL	
						AMITA 3	AMITA 3 PLUS
SZ110, 111, 160, 161	9,5 mm	3	15.5	15	L	SOL8712-150-15	
			14.8	17	L	SOL8712-148-17	
			14.5	19	L	SOL8712-148-17	
			14.3	21	L	SOL8712-143-21	
SZ200, 251, 301	11,5 mm	3	15	15	L	SOL8812-150-15	
			14,8	17	L	SOL8812-148-17	
			14.5	19	L	SOL8812-145-19	
			14.3	21	L	SOL8812-143-21	
			14.2	23	L	SOL8812-142-23	
			15.8	15	L		SOL8812-158-15
			15.5	17	L		SOL8812-155-17
15.3	19	L		SOL8812-153-19			
15.3	21	L		SOL8812-153-21			

### HELICES DE ACERO INOXIDABLE

Para colas YANMAR ZT350 y ZT370  
Hélices delanteras de 4 palas. Hélices traseras de 3 palas.  
19 estrías y escape a través de la hélice.

### STAINLESS STEEL PROPELLERS

For YANMAR sterndrives ZT350 Et ZT370  
Front propellers with 4 blades.  
Rear propellers with 3 blades.  
19 Tooth Spline and Thru hub exhaust.

### ELICHE IN ACCIAIO INOX

Per piedi YANMAR ZT350 e ZT370  
Elica anteriori di 4 pale. Elica posteriore di 3 pale.  
19 denti, scarico all'elica.

### HÉLICES EN ACIER INOX.

Pour Yanmar ZT350 et ZT370.  
Hélice avant 4 pales.  
Hélice arrière 3 pales.  
19 cannelures et l'échappement pour l'hélice.

OEM	DELANTERO FRONT ANTERIORE AVANT	TRASERO REAR POSTERIORE ARRIÈRE	A	B	D	P	R	AL
196350-09400	✓		19	4	16"	20	L	SOL1654-160-20
		✓		3	14 <sup>3/8</sup> "	20	R	SOL1651-144-20
	✓			4	16"	21	L	SOL1654-160-21
196350-09420		✓	19	3	14 <sup>3/8</sup> "	21	R	SOL1651-144-21
	✓			4	15 <sup>3/4</sup> "	22	L	SOL1654-158-22
		✓		3	14 <sup>1/4</sup> "	22	R	SOL1651-143-22
196350-09720	✓		19	4	15 <sup>3/4</sup> "	23	L	SOL1654-158-23
		✓		3	14 <sup>1/4</sup> "	23	R	SOL1651-143-23
	✓			4	15 <sup>1/2</sup> "	24	L	SOL1654-155-24
196350-09440		✓	19	3	14"	24	R	SOL1651-140-24
	✓			4	15 <sup>1/2</sup> "	25	L	SOL1654-155-25
		✓		3	14"	25	R	SOL1651-140-25
196350-09460	✓		19	4	15 <sup>1/2</sup> "	26	L	SOL1654-155-26
		✓		3	14"	26	R	SOL1651-140-26
	✓			4	5"	27	L	SOL1654-155-27
196350-09760		✓	19	3	13 <sup>3/4</sup> "	27	R	SOL1651-140-27
	✓			4	5"	28	L	SOL1654-150-28
		✓		3	13 <sup>3/4</sup> "	28	R	SOL1651-138-28
196350-09480	✓		19	4	5"	28	L	SOL1654-150-28
196350-09780		✓	19	3	13 <sup>3/4</sup> "	28	R	SOL1651-138-28

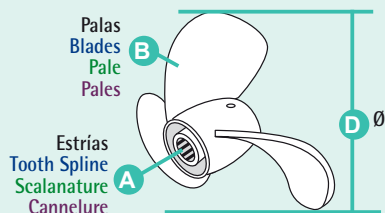

**P** Paso  
Pitch  
Passo  
Pas

**R** Rotación L (izquierda) R (derecha)  
Rotation L (left) R (Right)  
Rotazione L (SX) R (DX)  
Rotation L (gauche) R (droit)

REF--> OEM

REF	OEM
<b>A</b>	
AMITA 3	774
AMITA 3 Plus	774
<b>B</b>	
BRA125-1/2x1/2	724
BRA125-1/2x3/4	724
BRA125-1/2x3/8	724
BRA125-1/4x1/2	724
BRA125-1/4x3/8	724
BRA125-1x3/4	724
BRA125-3/16x1/4	724
BRA125-3/4x3/4	724
BRA125-3/8x1/2	724
BRA125-3/8x3/8	724
BRA125-5/16x3/8	724
BRA125-5/8x3/4	724
BRA125-5/8x3/8	724
<b>C</b>	
CEF500100GX	736
CEF500113	710-753
CEF500114T	712
CEF500161	119593-42200
CEF500161	119593-42201
CEF500162G	10-1286-01
CEF500162G	119574-42550
CEF500162G	119574-42552
CM19642002652A	196420-02652
CM19642002652A	196450-02492
CM19642002652Z	196420-02652
CM19642002652Z	196450-02492
CM19644002660KITA	196440-02660
CM19644002660KITA	196450-02501
CM19644002660KITZ	196440-02660
CM19644002660KITZ	196450-02501
CMC10421141-300	104211-41300
CMC272100-20030	27210-20030
<b>G</b>	
GS30430	724
GS30431	724
GS30432	724
GS30433	724
GS31055	724
GS31056	724
GS31066	724
GS35031	724
GS35032	724
GS35049	723
GS35050	723
GS35051	723
GS35052	723
GS35053	723
GS35054	723
GS35055	723
GS38107	128270-08341
GS38108	124772-08341
GS38120	124770-12540
GS38121	121370-08351
<b>J</b>	
JOH09-810B	712
<b>M</b>	
MAR119171-13490INOX	119171-13490
MAR119171-13530INOX	119171-13530
MAR119174-13501INOX	119174-13501
MAR119574-13530INOX	119574-13530
MAR119588-13501INOX	119588-13501
MAR119773-13501INOX	119773-13501
MAR119773-13501INOX	119773-13501
MAR128370-13550INOX	128370-13550
MAR128890-13530INOX	128890-13530
MAR129470-13550INOX	129470-13550
MAR129671-13552INOX	129671-13552
MAR13200	724770-13200
MAR13561	129470-13560
MAR13561	129470-13561
MAR13561	129670-13560
MAR13561	129670-13561
MAR3520	104070-13520
MAR3520	104214-13521
MAR3520	104214-13531
MAR3520	127070-13520
MAR3520	128370-13600
MAR3520	128990-13520
<b>R</b>	
RAC1/2F-1/2M	724
RAC1/2X16	724
RAC1/2X18	724
RAC1/2X20	724
RAC1000MA30	718
RAC1000VMA	718
RAC120AS	719
RAC2010PM-OR	718
RAC2010SM-OR	718
RAC2010TM-OR	718
RAC2010TM-OR	720
RAC2020PM-OR	718
RAC2020SM-OR	718
RAC2020TM-OR	718
RAC2040PM-OR	718

REF	OEM
RAC2040SM-OR	718
RAC2040TM-OR	718
RAC230R2	719
RAC245R2	719
RAC3/8F-3/8M	724
RAC3/8X10	724
RAC3/8X12	724
RAC3/8X14	724
RAC460R2	719
RAC490R2	719
RAC500MA30	718
RAC75/1000MA30	718
RAC75/500MAX	718
RAC900MA30	718
RAC900VMA	718
RACR11T	719
RACR120P	719
RACR120SM	719
RACR120TM	719
RACR12P	719
RACR12S	719
RACR12T	719
RACR20P	719
RACR20S	719
RACR20T	719
RACR24P	719
RACR24S	719
RACR24T	719
RACR25P	719
RACR25S	719
RACR25T	719
RACR26P	719
RACR26S	719
RACR26T	719
RACR60P	719
RACR60S	719
RACR60T	719
RACR90P	719
RACR90S	719
RACR90T	719
RACRK19492UL	725
RACRK20726	725
RACRK22628	725
REC040122	747
REC104211-11100	104211-11100
REC104211-11110	104211-11110
REC104211-41300	104211-41300
REC104211-41300AL	104211-41300
REC104211-42090	104211-42090
REC104211-49160	104211-49160
REC104211-77011	104211-77011
REC104211-77011	104211-77011
REC104500-55710	104500-55710
REC104511-11100	104511-11100
REC104511-78780E	104511-78780E
REC105225-02020	105225-02020
REC105225-02040	105225-02040
REC105225-11100	105225-11100
REC105225-11110	105225-11110
REC105582-49200	105582-49200
REC105582-49200	124223-49250
REC105582-49200	181130-49200
REC105582-49200	710-711-712-713
REC105582-52010	105582-52010
REC105582-82041	105582-82041
REC114362-77011	114361-77011
REC114362-77011	114362-77011
REC114362-77011	114362-77011
REC114362-77011	114362-77011
REC114362-77011	114399-77011
REC119000-01771	119000-01771
REC119000-32020	119000-32020
REC119000-42021	119000-42021
REC119005-35100	109005-35170
REC119005-35100	119005-35100
REC119005-35100	119005-35151
REC119005-35100	713-714
REC119100-11360	119100-11360
REC119100-12113	119100-12113
REC119171-11110	119171-11110
REC119171-11150	119171-11150
REC119171-13510	119171-13510
REC119171-18010	119171-18010
REC119172-18011	119172-18011
REC119172-18030	119172-18030
REC119173-11101	119173-11101
REC119173-13501INOX	119173-13501
REC119173-18011	119173-18011
REC119173-18041	119173-18041
REC119173-18940	119173-18940
REC119174-01340	119174-01340
REC119174-13201	119174-13201
REC119175-18031	119175-18031
REC119181-13500INOX	119181-13500
REC119195-18031	119195-18031
REC119195-18880	119195-18880
REC119305-35151	119305-35151
REC119415-01330	119415-01330
REC119573-77201	119573-77200
REC119573-77201	119573-77201
REC119573-77201	129470-77200

REF	OEM
REC119573-77201	129772-77200
REC119574-18020	119574-18020
REC119574-42502	119574-42500
REC119574-42502	119574-42501
REC119574-42502	119574-42502
REC119574-42550	119574-42550
REC119574-42550	119574-42552
REC119578-18010	119578-18010
REC119578-42501	119578-42500
REC119578-42501	119578-42501
REC119593-11110	119593-11110
REC119593-11380	119593-11380
REC119593-18880	119593-18880
REC119593-22351	119593-22351
REC119593-35100	119593-35100
REC119593-35400	119593-35400
REC119593-42280E	119593-42280
REC119593-42350	119593-42350
REC119593-49550	119593-49550
REC119595-01800	119595-01800
REC119595-22300	119595-22300
REC119609-32040	119609-32040
REC119717-01331	119717-01330
REC119717-01331	119717-01331
REC119717-02930	119717-02930
REC119717-11340	119717-11340
REC119717-11350	119717-11350
REC119770-00060	119770-00060
REC119770-00130	119770-00130
REC119770-00250	119770-00250
REC119770-00260	119770-00260
REC119770-00480	119770-00480
REC119770-00490	119770-00490
REC119770-00930	119770-00930
REC119770-00940	119770-00940
REC119770-00950	119770-00950
REC119770-01010	119770-01010
REC119770-01020	119770-01020
REC119770-01030	119770-01030
REC119770-01040	119770-01040
REC119770-02031	119770-02031
REC119770-90090	119770-90090
REC119770-90290	119770-90290
REC119770-90620	119770-90620
REC119770-91030	119770-91030
REC119771-00040	119771-00040
REC119771-00041	119771-00041
REC119771-00411	119771-00411
REC119771-00421	119771-00421
REC119773-18010	119773-18010
REC119773-42502	119773-42501
REC119773-42502	119773-42502
REC119773-42502	119773-42650
REC119773-42502	119773-42651
REC119773-42502	119773-42652
REC119773-42570	119773-42570
REC119773-49550	119773-49550
REC119773-55510	119773-55510
REC119773-77010	119773-77010
REC119773-77201	119773-77200
REC119773-77201	119773-77201
REC119775-18010	119775-18010
REC119775-77260	119773-77250
REC119775-77260	119775-77260
REC119775-77260	119775-77260
REC119802-55810	119802-55810
REC119836-77201	119836-77201
REC119836-77201	119836-77200
REC119836-77201	119836-77201
REC119836-77201	129930-77211
REC120130-91370	120130-91370
REC120324-55760	120324-55760
REC120650-55040	120650-55040
REC121000-01751	121000-01750
REC121000-01751	121000-01751
REC121000-03071	121000-03070
REC121000-03071	121000-03071
REC121000-42052	121000-42050
REC121000-42052	121000-42051
REC121000-42052	121000-42052
REC121254-77012	121254-77010
REC121254-77012	121254-77011
REC121254-77012	121254-77012
REC121254-77012	121254-77019
REC121254-77012	129429-77010
REC121254-77012	129429-77011
REC121254-77012	171058-77010
REC121370-55601	121370-55601
REC121370-55601	124790-55601
REC121400-11340	121400-11340
REC121450-01801	121450-01801
REC121450-02100	121450-02100
REC121450-02110	121450-02110
REC121450-02160	121450-02160
REC121450-02170	121450-02170
REC121450-11310	121450-11310
REC121450-11681	121450-11680
REC121450-11681	121450-11681
REC121450-32021	121450-32021
REC121450-44411	121450-44410
REC121450-44411	121450-44411
REC121520-01851	121520-01850

YANIMAR

RECAMBIOS MARINOS



REF	OEM		REF	OEM		REF	OEM	
REC121520-01851	121520-01851	752	REC128397-42500	128377-42500	735	REC129698-77010	121370-77010	730
REC121575-01334	121575-01334	744	REC128397-42500	128397-42500	735	REC129698-77010	129242-77010	730
REC121575-01334	121575-01332	744	REC128397-42500	128990-42510	735	REC129698-77010	129608-77010	730
REC121575-01334	121575-01333	744	REC128610-77350		714	REC129698-77010	129698-77010	730
REC121575-01334	121575-01334	744	REC128619-11100	128619-11100	763	REC129792-13552INOX	129579-13551	764
REC121575-01510	121575-01510	753	REC128619-11100	128619-11110	763	REC129792-13552INOX	129671-13551	764
REC121575-01510	121575-01511	753	REC128620-42201		714	REC129792-13552INOX	129792-13550	764
REC121575-01510	121575-01512	753	REC128625-01342	128625-01342	744	REC129792-13552INOX	129792-13551	764
REC121575-01861	121575-01861	751	REC128625-23361	128625-23361	761	REC129792-13552INOX	129792-13552	764
REC121750-49800	121750-49800	710-711-712-734	REC128628-42200		714	REC129795-01800	129795-01800	757
REC121750-55701		734	REC128628-42203	128628-42203	754	REC129795-49551	129795-49551	735
REC121850-01800	121850-01800	710-713	REC128633-35400	128633-35400	714-722	REC129940-42310E	129940-42310E	711-732
REC121850-11100	121850-11100	757	REC128670-77350	128670-77350	711-732	REC13554-0001	10-24493-01	714-736
REC121850-11100	121850-11100	763	REC128671-01330	128671-01330	743	REC13554-0001	191773-42600	754
REC121850-11150	121850-11150	762-763	REC128695-42780		710-713	REC13554-0001	191773-42601	754
REC121850-42280E	121850-42280E	713-714-732	REC128695-44780		711-712	REC1411-0001	128176-42080	753
REC121850-49811	121850-49811	713-714-734	REC128990-49800	128990-49800	711-712-734	REC145640-48410	145640-48410	714-734
REC121850-51960	121850-51960	755	REC128990-77350		712	REC160ELEMENT		720
REC121857-55710	121857-55710	713-714-716	REC128990-77550	120270-77511	733	REC165000-69590		714
REC123672-01782	123672-01782	757	REC128990-77550	128990-77550	733	REC165000-69590	165000-69590	735
REC123672-77370		711	REC128990-77911	128990-77911	733	REC1766160		720
REC123682-48601		712-714	REC128990-77911	128990-77911	733	REC196350-02350	196350-02350	768
REC124000-01751	124000-01750	752	REC128991-12500		712	REC196350-02350AL	196350-02350	768
REC124000-01751	124000-01751	752	REC128991-42200		712	REC196350-02550	196350-02550	768
REC124060-39452	124060-39452	729	REC129001-01340	129001-01340	743	REC196350-02550AL	196350-02550	768
REC124060-39452	124060-39452	729	REC129001-02931	129001-02931	760	REC196350-02570	196350-02570	768
REC124085-02220	124085-02220	757	REC129002-01331	128271-01911	743	REC196350-02570AL	196350-02570	768
REC124160-34845	124160-34844	751	REC129005-11100	129005-11100	763	REC196350-09910	196350-09910	767
REC124160-34845	124160-34845	751	REC129005-22500	129005-22500	758	REC196350-09910AL	196350-09910	767
REC124223-42110	124223-42110	737	REC129100-01621	129100-01621	753	REC196440-02690	196440-02690	768
REC124240-01883	124240-01882	752	REC129100-11100	129100-11100	763	REC196440-02690AL	196440-02690	768
REC124240-01883	124240-01883	752	REC129100-11112	129100-11112	763	REC196450-02501	196450-02501	768
REC124250-77012	121256-77011	730	REC129120-11100	129120-11100	763	REC196450-02501AL	196440-02660	768
REC124250-77012	124250-77012	730	REC129120-11110	129120-11110	763	REC196450-02501AL	196450-02501	768
REC124250-77012	124450-77011	730	REC129120-35121	129120-35121	722	REC196630-02670	196630-02670	767
REC124250-77012	124772-77010	730	REC129150-01511	129150-01511	753	REC196630-02670AL	196630-02670	767
REC124250-77012	124772-77020	730	REC129150-01531	129150-01531	753	REC196640-02680	196640-02680	768
REC124250-77012	129573-77010	730	REC129150-01881	129150-01881	735-736-737	REC196640-02680AL	196640-02680	768
REC124250-77012	171006-77010	730	REC129150-02800	129150-02800	759	REC21213660		735
REC124250-77012	171008-77010	730	REC129150-02931	129150-02931	761	REC21213660	129470-42352	754
REC124411-01780	124411-01780	757	REC129150-12111	129150-12111	749	REC21213660	129470-42530	754
REC124460-11340	124460-11340	763	REC129150-13110	129150-13110	749	REC21213660	129670-42530	754
REC124550-35110	124085-35113	721	REC129150-23601	129150-23601	760	REC21213660	129670-42531	754
REC124550-35110	124550-35110	721	REC129150-35042	129150-35042	722	REC21213660	129670-42531	754
REC124550-35110		711-712	REC129150-35111	129150-35111	736	REC21213660		711-712-713-736-754
REC124610-01862	124610-01861	751	REC129150-35150		712-713	REC22190-060002	22190-060002	756
REC124610-01862	124610-01862	751	REC129150-35151		711	REC22190-080002	22190-080002	756
REC124617-91850	124617-91850	733	REC129150-35153	129150-35153	722	REC22190-100002	22190-100002	756
REC124626-35420	124626-35420	714	REC129150-35153	129150-35170	722	REC22190-120002	22190-120002	756
REC124722-42290		712	REC129150-35153		711-712-713	REC22190-140002	22190-140002	756
REC124732-42290		710	REC129150-77511	129150-77511	749	REC22190-240002	22190-240002	756
REC124770-12540	124770-12540	723	REC129158-52101	129158-52101	725	REC22779-0001	124223-42091	754
REC124950-11340	124950-11340	762	REC129171-01330	129171-01330	744	REC22779-0001	124223-42092	754
REC126630-42030		714	REC129198-01750	129198-01750	752	REC22779-0001	128296-42070	754
REC126634-11340		714	REC129271-42502	129271-42502	735	REC22779-0001	128620-42200	754
REC126650-35220		714	REC129271-42502	129271-42501	735	REC22779-0001		710-711-712
REC126650-35350	126650-35350	721	REC129271-42502	129271-42502	735	REC23414-080000	23414-080000	756
REC127605-48590	127605-48590	715-734	REC129271-77950	129271-77950	733	REC23414-100000	23414-100000	756
REC127610-22501	127610-22501	758	REC129350-49541	129350-49540	735	REC23414-120000	23414-120000	756
REC127610-91350	127610-91350	729	REC129350-49541	129350-49541	735	REC23414-250000	23414-250000	756
REC127616-11280	127616-11280	762	REC129400-01751	129400-01751	752	REC24311-000100	24311-000100	755
REC127692-18880	127692-18880	723	REC129407-01340	129407-01340	744-748	REC24311-000120	24311-000120	755
REC127695-35150	127695-35150	721	REC129408-01330	129408-01330	744-748	REC24311-000160	24311-000160	755
REC127695-35150	127695-35160	721	REC129470-01550	129470-01550	755	REC24311-000320	24311-000320	755
REC127695-35150		712-713-714	REC129470-12130	129470-12130	749	REC24311-000700	24311-000700	755
REC127695-55630	127695-55630	714-715-716	REC129470-12330	129470-12330	723	REC24321-000350	24321-000350	755
REC128170-01331	128170-01330	743	REC129470-12330		711-712-713	REC24321-000350	24325-000350	755
REC128170-01331	128170-01330	748	REC129470-35040	129470-35040	722	REC24341-000240	24341-000240	737
REC128170-01331	128170-01331	743	REC129470-35121	129470-35121	722	REC25132-002700	25132-002700	732
REC128170-01510	128170-01510	753	REC129470-42531		712	REC25132-003000	25132-003000	710-713-732
REC128170-01751	128170-01750	752	REC129470-49801	129470-49801	734	REC25132-003100	25132-003100	710-732
REC128170-01751	128170-01751	752			711-712-713	REC25132-003700	25132-003700	710-711-732
REC128170-03070	128170-03070	751	REC129470-55703	129470-55703	716	REC25132-004250E	25132-004250	714-732
REC128170-11310	128170-11310	748	REC129472-13520	129472-135201	750-764-766	REC25132-004500	25132-004500	711-712-713-732
REC128170-12540	128170-12540	710-723	REC129472-18090	129472-18090	726-727-728-750-764-766	REC25132-004600	25132-004600	732
REC128170-13201	128170-13201	750	REC129473-18000	129473-18000	727	REC25132-004600	25132-004600	712-713-732
REC128170-32030	128170-32030	722	REC129474-18001	129474-18001	728	REC25152-004300	25152-004300	713-732
REC128170-42090	128170-42090	737	REC129486-42050	129150-42020	736	REC2656613		720
REC128170-77010	128170-77010	730	REC129486-42050	129486-42050	736	REC27200-400400	27200-400400	767
REC128170-77010	128170-77010D	730	REC129497-18000	129497-18000	727	REC27210-01302		767
REC128170-77350	128170-77350	710-732	REC129550-13110	129550-13110	749	REC27210-01302AL		767
REC128171-01911	128171-01330	743	REC129553-01350	129553-01350	744	REC27210-200200	27210-200200	767
REC128171-01911	128171-01911	743	REC129573-01351	129573-1351	744-748	REC27210-200300	27210-200300	767
REC128171-01911	128171-01911	748	REC129574-55711	129574-55711	712-716	REC27210-200370	27210-200370	767
REC128171-12540		710	REC129590-22510	129590-22510	758	REC27210-200700	27210-200700	767
REC128270-11310	128270-11310	748	REC129593-01350		748	REC27210-200550	177301-549000	767
REC128270-12540	128270-12540	710-7						

REF	OEM		REF	OEM		REF	OEM	
REC3841697	127610-42200	754	REC719000-02930	719000-02930	762	TEN01304	196630-02670	769
REC3841697		713-714	REC719000-22501	719000-22501	758	TEN01305	196420-02640	772
REC3GMWC	121450-13251	740	REC719171-92602	719171-92602	744-747	TEN01305	196420-02652	773
REC3GMWC	123682-44201	740	REC719173-92600	719173-92600	744-747	TEN01305/1	126450-02501	773
REC3GMWC	128297-44030	740	REC719174-23601	719174-23601	761	TEN01305/1	126450-02600	773
REC3GMWC	128390-44491	740	REC719593-02590	719593-02590	762	TEN01305/1	196440-02660	770
REC3GMWC	128695-44070	740	REC719593-23601	719593-23601	761	TEN01305/1	196450-02501	770
REC3GMWC	243111-000160	740	REC719595-23600	719595-23600	761	TEN01306	177301-549000	769
REC3GMWC	243111-000700	740	REC719717-02901	719717-02901	759	TEN01306	27210-200550	769
REC3GMWC		739	REC721000-22500	72100-22500	758	TEN01308	104211-41300	769
REC3JHWC	120322-33050	741	REC721575-22500	705311-22500	758	TEN01310	27200-400400	769
REC3JHWC	120445-44611	741	REC721575-22500	721575-22500	758	TEN01311	27200-300400	714-769
REC3JHWC	129150-13110	741	REC728170-92600	728170-92600	743-745	TEN01312	27210-200370	714-769
REC3JHWC	129670-44150	741	REC728171-92601	728171-92601	743-745	TEN01316	27210-200370	713-715-770
REC3JHWC	24321-000750	741	REC728171-92601	728176-92600	745	TEN01316T	119574-44150	770
REC3JHWC		739	REC728171-92601	728176-92601	745	TEN01316TP		770
REC3YMWC	119717-13110	741	REC728270-42002	128270-42000	736	TEN01317	177301-54900	713-714-770
REC3YMWC	128990-44100	741	REC728270-42002	128270-42001	736	TEN01317T	119574-18790	714-715-738-
REC3YMWC		739	REC728270-42002	128270-42002	736	TEN01317T		770
REC41650-501140	41650-501140	714-717	REC728271-92605	728271-92605	743-746	TEN01317TP		770
REC41650-502320	41650-502320	712-713-714-	REC728370-92605	728370-92605	743	TEN01318	27210-200370	770
		717	REC728374-92605	728374-92605	743-746	TEN01318T	119574-44150	740-741-742-
REC41650-502330	41650-502330	712-714-715-	REC728633-22500	728633-22500	758	TEN01318TP		770
REC43400-500450	43400-500450	756	REC728790-92600	728790-92600	743-745	TEN01319	196640-62680	770
REC47-809866T		715	REC728990-92600	728990-92600	743-746	TEN01390-1	196350-02550	770
REC4JHIC	129573-18120	738	REC729120-22500	729120-22500	758	TEN01391-1	196350-02570	770
REC4JHIC	129672-18170	738	REC729171-92600	729171-92600	744-746	TEN01392-1	196350-09910	770
REC4JHOC	120322-33050	742	REC729270-92601	729270-92601	743-746	TEN01393-1	196350-07360	769
REC4JHOC	129673-33050	742	REC729271-92600	729271-92600	743-746	TEN01394-1	196350-02350	770
REC4JHOC	24321-000750	742	REC729407-92605		744	TENKITYANMARSTD		770
REC4JHOC	24321-000800	742	REC729408-92605	729408-92600	746	TENPLAC-1	196440-02690	770-773
REC4JHOC		741	REC729408-92605	729408-92605	746	TRI305-0386		724
REC4JHWC	120322-33050	741	REC729408-92605		744	TRI305-0566		724
REC4JHWC	120445-44611	741	REC729470-92605	729470-92605	744-747			
REC4JHWC	127677-33060	741	REC729573-92605	729573-92605	746-747			
REC4JHWC	129550-13110	741	REC729670-92600	729670-92600	742-747			
REC4JHWC	129573-44470	741	REC729693-92600	729693-92600	744-746			
REC4JHWC	129672-44150	741	REC876614	129171-67200	733	YANMAR1GM SERIES		748
REC4JHWC	129693-44420	741	REC889419	889419	718	YANMAR2GM SERIES		748
REC4JHWC	24321-000750	741	REC889422	889422	718	YANMAR3GM SERIES		748
REC4JHWC	24321-000800	741	REC930122	930122	747	YANMAR4JH SERIES		748
REC4JHWC	24321-001000	741	RECGS00530		720	YANMAR4LH SERIES		748
REC4JHWC		739	RECGS01030		720			
REC4LHIC	119175-18590	738	RECKITYZT350-ZT370AL		768			
REC4LHIC	119773-18350	738	RECKITYZT350-ZT370M		768			
REC4LHIC		738	RECKITYZT350-ZT370ZN		768			
REC4LHOC	119175-33350	742	RECRK21069		725			
REC4LHOC	119175-33370	742	RECSD20	196313-02591	772			
REC4LHOC	119175-33380	742	RECSD20	24321-000950	772			
REC4LHOC	24311-000180	742	RECSD25	24341-000125	772			
REC4LHOC	24311-000900	742	RECSD25	196313-02591	772			
REC4LHOC		741	RECSD25	196420-12240	772			
REC4LHWC	119171-44470	741	RECSD25	24341-000125	772			
REC4LHWC	119174-44470	741	RECSD40	196440-02871	772			
REC4LHWC	119175-33350	741	RECSD40	24321-000950	772			
REC4LHWC	119175-33370	741	RECSD40	24341-000125	772			
REC4LHWC	119175-33380	741	RECSD40		773			
REC4LHWC	24311-000300	741	REC SWK-2000/10		720			
REC4LHWC	24311-001000	741	REC SWK-2000/5		720			
REC4LHWC	24311-001200	741	REC X02173476	X02173476	737			
REC500MA	22677639	720	REC X02173476	X0506597	737			
REC500MA	35-850481	720	REC XN199611	XN199611	713-714-723			
REC500MA	35-850481A1	720						
REC500MACON		725	SED3092500	119773-13500	765			
REC653-0001	10-1333701	735	SED3092500	119773-13501	765			
REC653-0001	10-24509-01	735	SOL1651-138-28	196350-09780	775			
REC653-0001	128990-42200	754	SOL1651-140-24	196350-09740	775			
REC653-0001	128990-42570	754	SOL1651-140-25		775			
		710-711-712-	SOL1651-140-26	196350-09760	775			
REC653-0001		735	SOL1651-140-27		775			
REC6LPIC	119773-18121	738	SOL1651-143-22	196350-09720	775			
REC6LPIC	119773-18350	738	SOL1651-143-23		775			
REC6LPOC	119175-33350	742	SOL1651-144-20	196350-09400	775			
REC6LPOC	119175-33370	742	SOL1651-144-21		775			
REC6LPOC	119773-33070	742	SOL1654-150-28	196350-09480	775			
REC6LPWC	119773-44071	741	SOL1654-155-24	196350-09440	775			
REC6LPWC	119773-44080	741	SOL1654-155-25		775			
REC6LPWC		740	SOL1654-155-26	196350-09460	775			
REC6LYIC	119578-18420	738	SOL1654-155-27		775			
REC6LYIC	119595-18600	738	SOL1654-158-22	196350-09420	775			
REC6LYIC	127677-33060	738	SOL1654-158-23		775			
REC6LYIC	23414-080000	738	SOL1654-160-20	196350-09400	775			
REC6LYOC	119574-33150	742	SOL1654-160-21		775			
REC6LYOC	119574-66160	742	SOL8712-143-21		774			
REC6LYOC	119578-33080	742	SOL8712-148-17		774			
REC6LYOC	119578-33121	742	SOL8712-150-15		774			
REC6LYOC	119578-33130	742	SOL8812-142-23		774			
REC6LYOC	119578-34020	742	SOL8812-143-21		774			
REC6LYOC	22190-100002	742	SOL8812-145-19		774			
REC6LYOC	24321-001500	742	SOL8812-148-17		774			
REC6LYWC	119175-33350	741	SOL8812-150-15		774			
REC6LYWC	119574-44170	741	SOL8812-153-19		774			
REC6LYWC	119578-44350	741	SOL8812-153-21		774			
REC6LYWC	119578-44420	741	SOL8812-155-17		774			
REC6LYWC	119578-44430	741	SOL8812-158-15		774			
REC6LYWC	24311-000400	741						
REC704571-22500	704571-22500	758	TEN01300	104211-41300	769			
REC705311-23600	705311-23600	760	TEN01301	27210-200300	714-769			
REC70720		725	TEN01302		769			
REC719000-02800	719000-02800	759	TEN01303	27210-200200	710-714-740-			
					769			



# OEM --> REF

OEM	REF		OEM	REF		OEM	REF	
889419	REC889419	718	119574-18020	REC119574-18020	728	119773-49550	REC119773-49550	714-734
889422	REC889422	718	119574-18790	TEN01317T	714-715-738-770	119773-55510	REC119773-55510	714-716
930122	REC930122	747	119574-33150	REC6LYOC	742	119773-77010	REC119773-77010	730
3581760	REC3581760	718	119574-42500	REC119574-42502	735	119773-77200	REC119773-77201	732
22677639	REC500MA	720	119574-42501	REC119574-42502	735	119773-77201	REC119773-77201	732
10-1286-01	CEF500162G	715-736	119574-42502	REC119574-42502	735	119773-77250	REC119775-77260	732
10-13170-01	REC119574-42502	735	119574-42550	CEF500162G	754	119775-18010	REC119775-18010	728
10-13328-03	REC21213660	735	119574-42550	REC119574-42550	754	119775-77260	REC119775-77260	732
10-1333701	REC653-0001	735	119574-42552	CEF500162G	754	119802-55810	REC119802-55810	716
10-24493-01	REC13554-0001	714-736	119574-42552	REC119574-42550	754	119836-77200	REC119836-77201	731
10-24509-01	REC653-0001	735	119574-44150	TEN01316T	770	119836-77201	REC119836-77201	731
104070-13520	MAR3520	764	119574-44150	TEN01318T	740-741-742-770	120130-91370	REC120130-91370	729
104211-11100	REC104211-11100	763	119574-44170	REC6LYWC	741	120270-77511	REC128990-77550	733
104211-11110	REC104211-11110	763	119574-66160	REC6LYOC	742	120322-33050	REC3JHWC	741
104211-41300	CMC10421141-300	771	119578-18010	REC119578-18010	728	120322-33050	REC4JHOC	742
104211-41300	REC104211-41300	767	119578-18420	REC6LYIC	738	120322-33050	REC4JHWC	741
104211-41300	REC104211-41300	767	119578-33080	REC6LYOC	742	120324-55760	REC120324-55760	717
104211-41300	REC104211-41300AL	767	119578-33121	REC6LYOC	742	120445-44611	REC3JHWC	741
104211-41300	REC104211-41300AL	767	119578-33130	REC6LYOC	742	120445-44611	REC4JHWC	741
104211-41300	TEN01300	769	119578-34020	REC6LYOC	742	120650-42310	REC3841697	754
104211-41300	TEN01308	769	119578-42500	REC119578-42501	736	120650-55040	REC120650-55040	714-717
104211-42070	REC3586494	753	119578-42501	REC119578-42501	736	121000-01750	REC121000-01751	752
104211-42071	REC3586494	753	119578-44350	REC6LYWC	741	121000-01751	REC121000-01751	752
104211-42090	REC104211-42090	737-752	119578-44420	REC6LYWC	741	121000-03070	REC121000-03071	751
104211-49160	REC104211-49160	735	119578-44430	REC6LYWC	741	121000-03071	REC121000-03071	751
104211-77010	REC104211-77011	731	119588-13501	MAR119588-13501INOX	766	121000-42050	REC121000-42052	737
104211-77011	REC104211-77011	731	119593-11110	REC119593-11110	763	121000-42052	REC121000-42052	737
104214-13521	MAR3520	764	119593-11380	REC119593-11380	749	121000-42052	REC121000-42052	737
104214-13531	MAR3520	764	119593-18880	REC119593-18880	714-723	121000-42052	REC121000-42052	737
104500-55710	REC104500-55710	710-711-712-717	119593-22351	REC119593-22351	758	121254-77010	REC121254-77012	731
104511-11100	REC104511-11100	763	119593-35100	REC119593-35100	715-721-742	121254-77011	REC121254-77012	731
104511-78780E	REC104511-78780E	712-737	119593-35400	REC119593-35400	742	121256-77011	REC124250-77012	730
105225-02020	REC105225-02020	755	119593-42200	CEF500161	754	121370-08351	GS38121	771
105225-02040	REC105225-02040	753	119593-42201	CEF500161	754	121370-55601	REC121370-55601	717
105225-11100	REC105225-11100	763	119593-42280	REC119593-42280E	732	121370-77010	REC129698-77010	730
105225-11110	REC105225-11110	763	119593-42350	REC119593-42350	715-732	121400-11340	REC121400-11340	763
105582-49200	REC105582-49200	734	119593-49550	REC119593-49550	734	121450-01801	REC121450-01801	757
105582-52010	REC105582-52010	725	119595-01800	REC119595-01800	757	121450-02100	REC121450-02100	760
105582-82041	REC105582-82041	753	119595-18600	REC6LYIC	738	121450-02110	REC121450-02110	760
109005-35170	REC119005-35100	721	119595-22300	REC119595-22300	758	121450-02160	REC121450-02160	761
114361-77011	REC114362-77011	730	119609-32040	REC119609-32040	755	121450-02170	REC121450-02170	759
114362-77010	REC114362-77011	730	119612-77230	REC119612-77230	731	121450-11310	REC121450-11310	749
114362-77011	REC114362-77011	730	119717-01330	REC119717-01331	743	121450-11680	REC121450-11681	751
114399-77010	REC114362-77011	730	119717-01331	REC119717-01331	743	121450-11681	REC121450-11681	751
119000-01771	REC119000-01771	751	119717-02930	REC119717-02930	761	121450-11681	REC2GMWC	740
119000-32020	REC119000-32020	722	119717-11340	REC119717-11340	763	121450-13251	REC3GMWC	740
119000-42021	REC119000-42021	736	119717-11350	REC119717-11350	763	121450-32021	REC121450-32021	722
119005-35100	REC119005-35100	721	119717-13110	REC3YMWVC	741	121450-44410	REC121450-44411	735
119005-35151	REC119005-35100	721	119770-00060	REC119770-00060	749	121450-44411	REC121450-44411	735
119100-11360	REC119100-11360	749	119770-00130	REC119770-00130	762	121520-01850	REC121520-01851	752
119100-12113	REC119100-12113	749	119770-00250	REC119770-00250	759	121520-01851	REC121520-01851	752
119171-11110	REC119171-11110	763	119770-00260	REC119770-00260	761	121575-01331	REC121575-01334	744
119171-11150	REC119171-11150	763	119770-00480	REC119770-00480	763	121575-01332	REC121575-01334	744
119171-13490	MAR119171-13490INOX	765	119770-00490	REC119770-00490	763	121575-01333	REC121575-01334	744
119171-13510	REC119171-13510	750-765	119770-00930	REC119770-00930	745	121575-01334	REC121575-01334	744
119171-13530	MAR119171-13530INOX	765	119770-00940	REC119770-00940	745	121575-01510	REC121575-01510	753
119171-18010	REC119171-18010	726	119770-00950	REC119770-00950	745	121575-01511	REC121575-01510	753
119171-44470	REC4LHWC	741	119770-01010	REC119770-01010	761	121575-01512	REC121575-01510	753
119172-18011	REC119172-18011	727	119770-01020	REC119770-01020	761	121575-01861	REC121575-01861	751
119172-18030	REC119172-18030	727	119770-01030	REC119770-01030	761	121575-42200	REC128397-42500	735
119173-11101	REC119173-11101	763	119770-01040	REC119770-01040	761	121750-49800	REC121750-49800	710-711-712-734
119173-13501	REC119173-13501INOX	765	119770-02031	REC119770-02031	760	121850-01800	REC121850-01800	757
119173-18011	REC119173-18011	726	119770-90090	REC119770-90090	757	121850-11100	REC121850-11100	763
119173-18041	REC119173-18041	726	119770-90290	REC119770-90290	757	121850-11150	REC121850-11150	762-763
119173-18940	REC119173-18940	750	119770-90620	REC119770-90620	714-721	121850-42280E	REC121850-42280E	713-714-732
119174-01340	REC119174-01340	744-748	119770-91030	REC119770-91030	762	121850-49811	REC121850-49811	713-714-734
119174-13201	REC119174-13201	750	119771-00040	REC119771-00040	749	121850-51960	REC121850-51960	755
119174-13501	MAR119174-13501INOX	765	119771-00401	REC119771-00401	745	121857-55710	REC121857-55710	713-714-716
119174-44470	REC4LHWC	741	119771-00411	REC119771-00411	745	123672-01782	REC123672-01782	757
119175-18031	REC119175-18031	727	119771-00421	REC119771-00421	745	123682-44201	REC2GMWC	740
119175-18590	REC4LHIC	738	119773-13500	MAR119773-13501INOX	765	123682-44201	REC3GMWC	740
119175-33350	REC4LHOC	742	119773-13501	MAR119773-13501INOX	765	124000-01750	REC124000-01751	752
119175-33350	REC6LPOC	742	119773-13501	SED3092500	765	124000-01751	REC124000-01751	752
119175-33350	REC6LYWC	741	119773-18010	REC119773-18010	728	124060-3945	REC124060-39452	729
119175-33370	REC4LHOC	742	119773-18121	REC6LPIC	738	124060-39452	REC124060-39452	729
119175-33370	REC4LHWC	741	119773-18350	REC4LHIC	738	124085-02220	REC124085-02220	757
119175-33380	REC4LHOC	742	119773-18350	REC6LPIC	738	124085-35113	REC124085-35110	721
119175-33380	REC4LHWC	741	119773-33070	REC6LPOC	742	124160-34844	REC124160-34845	751
119181-13500	REC119181-13500INOX	765	119773-42501	REC119773-42502	736	124160-34845	REC124160-34845	751
119195-18031	REC119195-18031	726	119773-42502	REC119773-42502	736	124223-42091	REC22779-0001	754
119195-18880	REC119195-18880	713-715-722	119773-42570	REC119773-42570	737	124223-42092	REC22779-0001	754
		710-711-712-713-717	119773-42600	REC13554-0001	754	124223-42110	REC124223-42110	737
119305-35151	REC119305-35151	721	119773-42601	REC13554-0001	754	124223-49250	REC105582-49200	734
		721	119773-42650	REC119773-42650	736	124240-01882	REC124240-01883	752
119415-01330	REC119415-01330	743	119773-42651	REC119773-42651	736	124240-01883	REC124240-01883	752
119573-77200	REC119573-77201	731	119773-42652	REC119773-42652	736	124250-77012	REC124250-77012	730
119573-77201	REC119573-77201	731	119773-44071	REC6LPWC	741	124411-01780	REC124411-01780	757
119574-13530	MAR119574-13530INOX	766	119773-44080	REC6LPWC	741	124450-77011	REC124250-77012	730

OEM	REF		OEM	REF		OEM	REF	
124460-11340	REC124460-11340	763	128990-42200	REC653-0001	754	129670-42513	REC129670-42513	736
124550-35110	REC124550-35110	721	128990-42510	REC128397-42500	735	129670-42530	REC21213660	754
124610-01861	REC124610-01862	751	128990-42570	REC653-0001	754	129670-42531	REC21213660	754
124610-01862	REC124610-01862	751	128990-44100	REC3JHWC	741	129670-44150	REC3JHWC	741
124617-91850	REC124617-91850	733	128990-49800	REC128990-49800	711-712-	129671-13551	REC129792-13552INOX	764
124770-12540	GS38120	771	128990-77550	REC128990-77550	733	129671-13552	MAR129671-13552INOX	766
124770-12540	REC124770-12540	723	128990-77910	REC128990-77911	733	129671-18001	REC129671-18001	726
124772-08341	GS38108	771	128990-77911	REC128990-77911	733	129672-18170	REC4JHHC	738
124772-77010	REC124250-77012	730	128990-77911	REC128990-77911	733	129672-44150	REC4JHWC	741
124772-77020	REC124250-77012	730	129001-01340	REC129001-01340	743	129673-33050	REC4JHOC	742
124790-55601	REC121370-55601	717	129001-02931	REC129001-02931	760	129690-02800	REC129690-02800	759
124950-11340	REC124950-11340	762	129005-11100	REC129005-11100	763	129693-01331	REC129693-01331	744-748
126450-02501	TEN01305/1	773	129005-22500	REC129005-22500	758	129693-18000	REC129693-18001	728
126450-02600	TEN01305/1	773	129100-01621	REC129100-01621	753	129693-18001	REC129693-18001	728
126650-35350	REC126650-35350	721	129100-11100	REC129100-11100	763	129693-44420	REC4JHWC	741
127070-13520	MAR3520	764	129100-11112	REC129100-11112	763	129698-77010	REC129698-77010	730
127605-48590	REC127605-48590	715-734	129120-11100	REC129120-11100	763	129772-77200	REC119573-77201	731
127610-22501	REC127610-22501	758	129120-11110	REC129120-11110	763	129792-13550	REC129792-13552INOX	764
127610-42200	REC3841697	754	129120-35121	REC129120-35121	722	129792-13551	REC129792-13552INOX	764
127610-91350	REC127610-91350	729	129150-01511	REC129150-01511	753	129792-13552	REC129792-13552INOX	764
127616-11280	REC127616-11280	762	129150-01531	REC129150-01531	753	129795-01800	REC129795-01800	757
127677-33060	REC4JHWC	741	129150-01881	REC129150-01881	735-736-	129795-49551	REC129795-49551	735
127677-33060	REC6LYIC	738	129150-02800	REC129150-02800	737	129930-77211	REC119836-77201	731
127692-18880	REC127692-18880	723	129150-02931	REC129150-02931	761	129940-42310E	REC129940-42310E	732
127695-35150	REC127695-35150	721	129150-12111	REC129150-12111	749	145640-48410	REC145640-48410	714-734
127695-35160	REC127695-35150	721	129150-13110	REC129150-13110	749	165000-69950	REC165000-69950	735
127695-55630	REC127695-55630	714-715-	129150-13110	REC3JHWC	741	171006-77010	REC124250-77012	730
128170-01330	REC128170-01331	743	129150-23601	REC129150-23601	760	171008-77010	REC124250-77012	730
128170-01330	REC128170-01331	748	129150-35042	REC129150-35042	722	171058-77010	REC121254-77012	731
128170-01331	REC128170-01331	743	129150-35111	REC129150-35111	736	177301-54900	TEN01317	713-714-
128170-01510	REC128170-01510	753	129150-35153	REC129150-35153	722	177301-549000	REC27210-200550	770
128170-01511	REC128170-01510	753	129150-35170	REC129150-35153	722	177301-549000	TEN01306	767
128170-01750	REC128170-01751	752	129150-42020	REC129486-42050	736	181130-49200	REC105582-49200	769
128170-01751	REC128170-01751	752	129150-77511	REC129150-77511	749	196313-02591	REC105582-49200	734
128170-03070	REC128170-03070	751	129158-52101	REC129158-52101	725	196313-02591	RECS20	772
128170-11310	REC128170-11310	748	129171-01330	REC129171-01330	744	196350-02350	RECS25	772
128170-12540	REC128170-12540	710-723	129171-67200	REC876614	733	196350-02350	REC196350-02350	768
128170-13201	REC128170-13201	750	129198-01750	REC129198-01750	752	196350-02350	REC196350-02350AL	768
128170-32030	REC128170-32030	722	129242-77010	REC129698-77010	730	196350-02350	TEN01394-1	770
128170-42090	REC128170-42090	737	129271-42500	REC129271-42502	735	196350-02550	REC196350-02550	768
128170-77010	REC128170-77010	730	129271-42501	REC129271-42502	735	196350-02550	REC196350-02550AL	768
128170-77010D	REC128170-77010	730	129271-42502	REC129271-42502	735	196350-02570	TEN01390-1	770
128170-77350	REC128170-77350	710-732	129271-77950	REC129271-77950	733	196350-02570	REC196350-02570	768
128171-01330	REC128171-01911	743	129350-49540	REC129350-49541	735	196350-02570	REC196350-02570AL	768
128171-01911	REC128171-01911	743	129350-49541	REC129350-49541	735	196350-02570	TEN01391-1	770
128171-01911	REC128171-01911	748	129400-01751	REC129400-01751	752	196350-07360	TEN01393-1	769
128171-77200	REC128170-77200	731	129407-01340	REC129407-01340	744-748	196350-09400	SOL1651-144-20	775
128176-42080	REC1411-0001	753	129408-01330	REC129408-01330	744-748	196350-09400	SOL1654-160-20	775
128270-08341	GS38107	771	129429-77010	REC121254-77012	731	196350-09420	SOL1654-158-22	775
128270-11310	REC128270-11310	748	129429-77011	REC121254-77012	731	196350-09460	SOL1654-155-24	775
128270-12540	REC128270-12540	710-711-	129470-01550	REC129470-01550	755	196350-09460	SOL1654-155-26	775
128270-42000	REC728270-42002	736	129470-12130	REC129470-12130	749	196350-09480	SOL1654-150-28	775
128270-42001	REC728270-42002	736	129470-12330	REC129470-12330	723	196350-09720	SOL1651-143-22	775
128270-42002	REC728270-42002	736	129470-13550	MAR129470-13550INOX	766	196350-09740	SOL1651-140-24	775
128270-77200	REC128270-77200	731	129470-13560	MAR13561	764	196350-09760	SOL1651-140-26	775
128270-77201	REC128270-77200	731	129470-13561	MAR13561	764	196350-09780	SOL1651-138-28	775
128270-77202	REC128270-77200	731	129470-35040	REC129470-35040	722	196350-09910	REC196350-09910	767
128271-01911	REC128271-01911	743-748	129470-35121	REC129470-35121	722	196350-09910	REC196350-09910AL	767
128271-01911	REC128271-01911	743	129470-42352	REC21213660	754	196350-09910	TEN01392-1	770
128275-91340	REC128275-91340	729	129470-42530	REC21213660	754	196420-02640	TEN01305	772
128290-13251	REC2GMWC	740	129470-49801	REC129470-49801	711-712-	196420-02652	CM19642002652A	771
128296-42070	REC22779-0001	754	129470-55703	REC129470-55703	713-734	196420-02652	CM19642002652Z	771
128297-44030	REC3GMWC	740	129472-135201	REC129472-13520	711-712-	196420-12240	TEN01305	773
128300-13230	REC128300-13230	726-727-	129472-18090	REC129472-18090	713-716	196420-12240	RECS25	772
128370-01331	REC128370-01332	743	129473-18000	REC129473-18000	727	196440-02660	CM19644002660KITA	771
128370-01331	REC128370-01332	741-748	129474-18001	REC129474-18001	728	196440-02660	CM19644002660KITZ	771
128370-01332	REC128370-01332	743	129486-42050	REC129486-42050	736	196440-02660	REC196450-02501	768
128370-13181	REC128370-13181	750	129497-18000	REC129497-18000	727	196440-02660	REC196450-02501AL	768
128370-13201	REC128370-13201	750-764-	129550-13110	REC129550-13110	749	196440-02660	TEN01305/1	770
128370-13550	MAR128370-13550INOX	766	129550-13110	REC129550-13110	749	196440-02660	REC196440-02690AL	768
128370-13600	MAR3520	764	129553-01350	REC129553-01350	744	196440-02690	TENPLAC-1	770-773
128374-01911	REC128374-01911	743-748	129573-1351	REC129573-1351	744-748	196440-02871	RECS20	772
128377-42500	REC128397-42500	735	129573-18120	REC129573-18120	738	196450-02492	CM19642002652A	771
128390-44491	REC3GMWC	740	129573-44470	REC4JHHC	741	196450-02492	CM19642002652Z	771
128397-42500	REC128397-42500	735	129573-77010	REC124250-77012	730	196450-02501	CM19644002660KITA	771
128619-11100	REC128619-11100	763	129574-55711	REC129574-55711	712-716	196450-02501	CM19644002660KITZ	771
128619-11110	REC128619-11110	763	129579-13551	REC129792-13552INOX	764	196450-02501	REC196450-02501	768
128620-42200	REC22779-0001	754	129590-22510	REC129590-22510	758	196450-02501	REC196450-02501AL	768
128625-01342	REC128625-01342	744	129601-11310	REC129601-11310	749	196450-02501	TEN01305/1	770
128625-23361	REC128625-23361	761	129608-77010	REC129608-77010	730	196630-02670	REC196630-02670	767
128628-42203	REC128628-42203	754	129612-42290E	REC129612-42290E	711-732	196630-02670	REC196630-02670AL	767
128633-35400	REC128633-35400	714-722	129670-13560	MAR13561	764	196640-62680	TEN01304	769
128670-77350	REC128670-77350	711-732	129670-13561	MAR13561	764	196640-62680	REC196640-02680	768
128671-01330	REC128671-01330	743	129670-42500	REC129670-42513	736	196640-62680	REC196640-02680AL	768
128695-44070	REC2GMWC	740	129670-42501	REC129670-42513	736	TEN01319	REC22190-060002	756
128695-44070	REC3GMWC	740	129670-42502	REC129670-42513	736	22190-060002	REC22190-080002	756
128890-13530	MAR128890-13530INOX	766	129670-42512	REC129670-42513	736	22190-100002	REC22190-100002	756
128990-13520	MAR3520	764				22190-100002	REC6LYOC	742
						22190-120002	REC22190-120002	756
						22190-140002	REC22190-140002	756
						22190-240002	REC22190-240002	756



OEM	REF		OEM	REF	
23414-080000	REC23414-080000	756	724770-13200	MAR13200	764
23414-080000	REC6LYIC	738	728170-92600	REC728170-92600	743-745
23414-100000	REC23414-100000	756	728171-92601	REC728171-92601	743-745
23414-120000	REC23414-120000	756	728176-92600	REC728171-92601	745
23414-250000	REC23414-250000	756	728176-92601	REC728171-92601	745
24311-000100	REC24311-000100	755	728271-92605	REC728271-92605	743-746
24311-000120	REC24311-000120	755	728370-92605	REC728370-92605	743
24311-000160	REC24311-000160	755	728374-92605	REC728374-92605	743-746
24311-000160	REC2GMWC	740	728633-22500	REC728633-22500	758
24311-000160	REC3GMWC	740	728790-92600	REC728790-92600	743-745
24311-000180	REC4LHOC	742	728990-92600	REC728990-92600	743-746
24311-000300	REC4LHWC	741	729120-22500	REC729120-22500	758
24311-000320	REC24311-000320	755	729171-92600	REC729171-92600	744-746
24311-000400	REC6LYWC	741	729270-92601	REC729270-92601	743-746
24311-000700	REC24311-000700	755	729271-92600	REC729271-92600	743-746
24311-000700	REC2GMWC	740	729408-92600	REC729408-92605	746
24311-000700	REC3GMWC	740	729408-92605	REC729408-92605	746
24311-000900	REC4LHOC	742	729470-92605	REC729470-92605	744-747
24311-001000	REC4LHWC	741	729573-92605	REC729573-92605	746-747
24311-001200	REC4LHWC	741	729670-92600	REC729670-92600	742-747
24321-000350	REC24321-000350	755	729693-92600	REC729693-92600	744-746
24321-000750	REC3JHWC	741	X02173476	RECX02173476	737
24321-000750	REC4JHOC	742	X0506597	RECX02173476	737
24321-000750	REC4JHWC	741	XN199611	RECXN199611	713-714-723
24321-000800	REC4JHOC	742			
24321-000800	REC4JHWC	741			
24321-000950	RECS20	772			
24321-000950	RECS40	772			
24321-001000	REC4JHWC	741			
24321-001500	REC6LYOC	742			
24325-000350	REC24321-000350	755			
24341-000125	RECS20	772			
24341-000125	RECS25	772			
24341-000125	RECS40	772			
24341-000240	REC24341-000240	755			
24341-000600	REC24341-000600	737			
25132-002700	REC25132-002700	732			
25132-003000	REC25132-003000	710-713-732			
25132-003100	REC25132-003100	710-732			
25132-003700	REC25132-003700	710-711-732			
25132-004250	REC25132-004250E	714-732			
25132-004500	REC25132-004500	711-712-713-732			
25132-004600	REC25132-004600	732			
25132-004600	REC25132-004600	712-713-732			
25152-004300	REC25152-004300	713-732			
27200-300400	REC27210-300400	767			
27200-300400	TEN01311	714-769			
27200-400400	REC27200-400400	767			
27200-400400	TEN01310	769			
27210-200200	REC27210-200200	767			
27210-200200	TEN01303	710-714-740-769-710-711-712-713-715-771			
27210-200300	CMC272100-20030	712-713-715-771			
27210-200300	REC27210-200300	767			
27210-200300	TEN01301	714-769			
27210-200370	REC27210-200370	767			
27210-200370	TEN01312	714-769			
27210-200370	TEN01316	713-715-770			
27210-200370	TEN01318	770			
27210-200550	REC27210-200550	767			
27210-200550	TEN01306	769			
35-850481	REC500MA	720			
35-850481A1	REC500MA	720			
41650-501140	REC41650-501140	714-717-713-714-717			
41650-502320	REC41650-502320	717			
41650-502330	REC41650-502330	714-715-717			
429670-42510	REC129670-42513	736			
429670-42511	REC129670-42513	736			
43400-500450	REC43400-500450	756			
704571-22500	REC704571-22500	758			
705311-22500	REC721575-22500	758			
705311-23600	REC705311-23600	760			
719000-02800	REC719000-02800	759			
719000-02930	REC719000-02930	762			
719000-22501	REC719000-22501	758			
719171-92602	REC719171-92602	744-747			
719173-92600	REC719173-92600	744-747			
719174-23601	REC719174-23601	761			
719593-02590	REC719593-02590	762			
719593-23601	REC719593-23601	761			
719595-23600	REC719595-23600	761			
719717-02901	REC719717-02901	759			
72100-22500	REC721000-22500	758			
721575-22500	REC721575-22500	758			

<b>BORG-WAGNER</b>	784	<b>CODO ESCAPE</b>	813	<b>PLEASURECRAFT</b>	832
DAMPER VELVET DRIVE	784	<b>FISHER PANDA</b>	814	ADAPTADOR GOMA	841
FILTRO ACEITE	784	BOMBAS AGUA	814	ALTERNADORES	840
KITS REPARACIÓN TRANSMISIÓN	785	GENERADORES	814	BOMBA AGUA	834
<b>CATERPILLAR</b>	785	<b>HURT</b>	815	BOMBA CIRCULACIÓN DE BLOQUE	833
ALTERNADORES	789	TRANSMISION	815	BOMBA COMBUSTIBLE	835
ÁNODOS	788	<b>INDMAR</b>	815	CARBURADOR	835
BOMBAS ASPIRACIÓN DE AGUA MARINA	786	ALTERNADORES	817	COMPONENTES DE COLA	841
COLECTORES	785	ARRANQUE	817	ENCENDIDO	836
ENFRIADOR COMBUSTIBLE	785	BOMBA ASPIRACIÓN AGUA MARINA	816	ESCAPE	832
FILTRO ACEITE	785	ENCENDIDO	816	FILTRO ACEITE	835
MOTORES DE ARRANQUE	789	ESCAPE	815	JUNTAS CULATA	832
SILENTBLOCK	789	TUBO COMBUSTIBLE	816	MOTORES DE ARRANQUE	840
<b>CHRIS-CRAFT</b>	790	<b>KOHLER</b>	818	POWER TRIM	841
BOMBAS AGUA	790	ÁNODOS	820	SENSORES	836
BOMBAS COMBUSTIBLE	791	BOMBAS AGUA	819	<b>RENAULT COUACH</b>	842
CARBURADORES	792	FILTRO	818	ÁNODOS	843
ENCENDIDO	792	GENERADORES	820	FILTRO ACEITE	842
FILTRO ACEITE	791	TERMOSTATO	819	IMPULSORES	842
JUNTAS CODO, CULATA	790	<b>MAN</b>	821	<b>SOLE DIESEL</b>	843
MOTORES DE ARRANQUE	795	BOMBAS AGUA	821	ÁNODOS	843
<b>CRUSADER</b>	795	<b>MASE</b>	822	IMPULSORES	843
BOMBA ASPIRACIÓN AGUA MARINA	799	BOMBAS AGUA	822	<b>VETUS</b>	844
BOMBA CIRCULACIÓN DE BLOQUE	799	GENERADORES	822	ÁNODOS	844
BOMBA COMBUSTIBLE	800	<b>NANNI DIESEL</b>	823	IMPULSORES	844
CARBURADORES	802	ALTERNADOR	823	<b>WESTERBEKE</b>	845
ENCENDIDO	804	IMPULSORES	823	ALTERNADORES	846
ESCAPE	796	<b>ONAN</b>	824	ÁNODOS	847
FILTRO	801	ÁNODOS	827	BOMBAS AGUA	846
JUNTAS DE MOTOR	795	BOMBA ASPIRACIÓN AGUA MARINA	825	FILTRO ACEITE	845
MOTORES DE ARRANQUE	808	BOMBAS DE AGUA	825	GENERADORES	847
SENSORES	803	FILTRO	824	KITS CARBURADOR	845
TERMOSTATO	801	GENERADORES	828	MOTORES DE ARRANQUE	845
<b>CUMMINS</b>	809	MOTORES DE ARRANQUE	828	<b>SHERWOOD</b>	849
ALTERNADORES	812	<b>PERKINS</b>	829	<b>JABSCO</b>	858
ÁNODOS	812	ÁNODOS	831	REF-->OEM	861
BOMBA ASPIRACIÓN AGUA MARINA	809	BOMBA AGUA	831	OEM-->REF	866
COLECTORES ESCAPE	809	BOMBA ASPIRACIÓN AGUA MARINA	830		
MOTORES DE ARRANQUE	812	ESCAPE	829		
SILENTBLOCK	809	FILTRO	829		
<b>DETROIT DIESEL</b>	813	MOTORES DE ARRANQUE	832		
ÁNODOS	813				
BOMBA ASPIRACIÓN AGUA MARINA	813				

<b>BORG-WAGNER</b>	784	<b>RAW MARINE WATER PUMP</b>	813	<b>WATER PUMPS</b>	831
DAMPER VELVET DRIVE	784	<b>FISHER PANDA</b>	814	<b>PLEASURECRAFT</b>	832
OIL FILTER	784	GENERATORS	814	ALTERNATORS	840
TRANSMISION REPAIR KIT	785	WATER PUMPS	814	BLOCK CIRCULATING PUMP	833
<b>CATERPILLAR</b>	785	<b>HURT</b>	815	BUSHING	841
ALTERNATORS	789	TRANSMISION	815	CARBURETORS	835
ANODES	788	<b>INDMAR</b>	815	CYLINDER HEAD GASKETS	832
FUEL COOLER	785	ALTERNATORS	817	EXHAUST	832
MANIFOLDS	785	EXHAUST	816	FUEL PUMP	835
OIL FILTER	785	FUEL TUBE	816	GEARHOUSING COMPONENTS	841
RAW MARINE WATER PUMPS	786	IGNITON	816	IGNITON	836
SILENTBLOCK	789	RAW MARINE WATER PUMP	816	OIL FILTER	835
STARTERS	789	STARTERS	817	POWER TRIM	841
<b>CHRIS-CRAFT</b>	790	<b>KOHLER</b>	818	SENSORS	836
CARBURETORS	792	ANODES	820	STARTERS	840
CYLINDER HEAD & ELBOW	790	FILTER	818	WATER PUMPS	834
FUEL PUMP	791	GENERATORS	820	<b>RENAULT COUACH</b>	842
IGNITON	792	THERMOSTAT	819	ANODES	843
OIL FILTER	791	WATER PUMPS	819	IMPELLER	842
STARTERS	795	<b>MAN</b>	821	OIL FILTER	842
WATER PUMPS	790	WATER PUMPS	821	<b>SOLE DIESEL</b>	843
<b>CRUSADER</b>	795	<b>MASE</b>	822	ANODES	843
BLOCK CIRCULATING PUMP	799	GENERATORS	822	IMPELLER	843
CARBURETORS	802	WATER PUMPS	822	<b>VETUS</b>	844
EXHAUST	796	<b>NANNI DIESEL</b>	823	ANODES	844
FILTER	801	ALTERNATORS	823	IMPELLER	844
FUEL PUMP	800	IMPELLER	823	<b>WESTERBEKE</b>	845
GASKETS	795	<b>ONAN</b>	824	ALTERNATORS	846
IGNITON	804	ANODES	827	ANODES	847
RAW MARINE WATER PUMP	799	FILTER	824	CARBURETOR KITS	845
SENSORS	803	GENERADORES	828	GENERATORS	847
STARTERS	808	RAW MARINE WATER PUMP	825	OIL FILTER	845
THERMOSTAT	801	STARTERS	828	STARTERS	845
<b>CUMMINS</b>	809	WATER PUMPS	825	WATER PUMPS	846
ALTERNATORS	812	<b>PERKINS</b>	829	<b>SHERWOOD</b>	849
ANODES	812	ANODES	831	<b>JABSCO</b>	858
EXHAUST MANIFOLDS	809	EXHAUST	829	REF-->OEM	861
RAW MARINE WATER PUMP	809	FILTER	829	OEM-->REF	866
SILENTBLOCK	809	RAW MARINE WATER PUMP	830		
STARTERS	812	STARTERS	832		
<b>DETROIT DIESEL</b>	813				
ANODES	813				
EXHAUST ELBOW	813				

IT

<b>BORG-WAGNER</b>	784	POMPE ASPIRAZIONE ACQUA MAINA	813	<b>PLEASURECRAFT</b>	832
DAMPER VELVET DRIVE	784	<b>FISHER PANDA</b>	814	ACCENSIONE	836
FILTRO OLIO	784	GENERATORI	814	ADATTATORE IN GOMMA	841
KIT RIPARAZIONE TRASMISSIONE	785	POMPE ACQUA	814	ALTERNATORI	840
<b>CATERPILLAR</b>	785	<b>HURT</b>	815	CARBURATORI	835
ALTERNATORI	789	TRASMISSIONE	815	COMPONENTI PIEDE	841
ANODI	788	<b>INDMAR</b>	815	GUARNIZIONI TESTATA	832
COLLETTORI	785	ACCENSIONE	816	FILTRO OLIO	835
FILTRO OLIO	785	ALTERNATORI	817	MOTORINI AVVIAMENTO	840
MOTORINI AVVIAMENTO	789	AVVIAMENTO	816	POMPE ACQUA	834
POMPE ASPIRAZIONE ACQUA MARNIA	786	MOTORINI AVVIAMENTO	817	POMPE BENZINA	835
SCAMBIATORE DE COMBUSTIBILE	785	POMPE ASPIRAZIONE ACQUA MARNIA	816	POMPA DI RICIRCOLO DI BLOCCO	833
SILENTBLOCK	789	SCARICO	815	POWER TRIM	841
<b>CHRIS-CRAFT</b>	790	TUBO COMBUSTIBILE	816	SCARICO	832
ACCENSIONE	792	<b>KOHLER</b>	818	SENSORI	836
CARBURATORI	792	ANODI	820	<b>RENAULT COUACH</b>	842
FILTRO OLIO	791	FILTRO	818	ANODI	843
GUARNIZIONE TESTATA, GOMITO	790	GENERATORI	820	FILTRO OLIO	842
MOTORINO AVVIAMENTO	795	POMPE ACQUA	819	GIRANTI	842
POMPE ACQUA	790	TERMOSTATO	819	<b>SOLE DIESEL</b>	843
POMPE BENZINA	791	<b>MAN</b>	821	ANODI	843
<b>CRUSADER</b>	795	POMPE ACQUA	821	GIRANTI	843
ACCENSIONE	804	<b>MASE</b>	822	<b>VETUS</b>	844
CARBURATORI	802	GENERATORI	822	ANODI	844
FILTRO	801	POMPE ACQUA	822	GIRANTI	844
GUARNIZIONE MOTORE	795	<b>NANNI DIESEL</b>	823	<b>WESTERBEKE</b>	845
MOTORINI AVVIAMENTO	808	ALTERNATORI	823	ALTERNATORI	846
POMPE ASPIRAZIONE ACQUA MARINA	799	GIRANTI	823	ANODI	847
POMPA BENZINA	800	<b>ONAN</b>	824	FILTRO OLIO	845
POMPA DI RICIRCOLO DI BLOCCO	799	ANODI	827	GENERATORI	847
SCARICO	796	FILTRO	824	KIT CARBURATORI	845
SENSORI	803	GENERATORI	828	MOTORINI AVVIAMENTO	845
TERMOSTATO	801	MOTORINI AVVIAMENTO	828	POMPE ACQUA	846
<b>CUMMINS</b>	809	POMPE ACQUA	825	<b>SHERWOOD</b>	849
ALTERNATORI	812	POMPE ASPIRAZIONE ACQUA MARINA	825	<b>JABSCO</b>	858
ANODI	812	<b>PERKINS</b>	829	REF-->OEM	861
COLLETTORI SCARICO	809	ANODI	831	OEM-->REF	866
MOTORINI AVVIAMENTO	812	FILTRO	829		
POMPE ASPIRAZIONE ACQUA MARNIA	809	MOTORINI AVVIAMENTO	832		
SILENTBLOCK	809	POMPE ACQUA	831		
<b>DETROIT DIESEL</b>	813	POMPE ASPIRAZIONE ACQUA MARNIA	830		
ANODI	813	SCARICO	829		
GOMITO SCARICO	813				

FR

<b>BORG-WAGNER</b>	784	POMPE À EAU DE MER	813	<b>PLEASURECRAFT</b>	832
DAMPER VELVET DRIVE	784	<b>FISHER PANDA</b>	814	ADAPTATEUR EN CAOUTCHOUC	841
FILTRE À HUILE	784	GENERATEURS	814	ALLUMAGE	836
KIT RÉPARATION TRANSMISSION	785	POMPE D'EAU	814	ALTERNATEUR	840
<b>CATERPILLAR</b>	785	<b>HURT</b>	815	CAPTEURS	836
ALTERNATEUR	789	TRANSMISSION	815	CARBURATEURS	835
ANODES	788	<b>INDMAR</b>	815	COMPOSANTS D'EMBASES	841
COLLECTEURS	785	ALLUMAGE	816	DÉMARREUR	840
DÉMARREUR	789	ALTERNATEUR	817	ÉCHAPPEMENT	832
FILTRE À HUILE	785	DÉMARREUR	817	FILTRE À HUILE	835
POMPE À EAU DE MER	786	DURITE CARBURANT	816	JOINTS DE CULASSE	832
REFROIDISSEUR D'ESSENCE	785	ECHAPPEMENT	815	POMPE D'EAU	834
SILENTBLOCK	789	POMPE À EAU DE MER	816	POMPE DE BRASSAGE	833
<b>CHRIS-CRAFT</b>	790	<b>KOHLER</b>	818	POMPE D'ESSENCE	835
ALLUMAGE	792	ANODES	820	POWER TRIM	841
CARBURATEURS	792	FILTRE	818	<b>RENAULT COUACH</b>	842
DÉMARREUR	792	GENERATEURS	820	ANODES	843
FILTRE À HUILE	791	POMPE D'EAU	819	FILTRE À HUILE	842
JOINTS COUDE, CULASSE	790	THERMOSTAT	819	TURBINE	842
POMPE D'EAU	790	<b>MAN</b>	821	<b>SOLE DIESEL</b>	843
POMPE D'ESSENCE	791	POMPE D'EAU	821	ANODES	843
<b>CRUSADER</b>	795	<b>MASE</b>	822	TURBINE	843
ALLUMAGE	801	GENERATEURS	822	<b>VETUS</b>	844
CAPTEURS	803	POMPE D'EAU	822	ANODES	844
CARBURATEURS	802	<b>NANNI DIESEL</b>	823	TURBINE	844
DÉMARREUR	808	ALTERNATEUR	823	<b>WESTERBEKE</b>	845
ÉCHAPPEMENT	796	TURBINE	823	ALTERNATEUR	846
FILTRE	801	<b>ONAN</b>	824	ANODES	847
JOINTS MOTEUR	795	ANODES	827	DÉMARREUR	845
POMPE À EAU DE MER	799	DÉMARREUR	828	FILTRE À HUILE	845
POMPE DE BRASSAGE	799	FILTRE	824	GENERATEURS	847
POMPE D'ESSENCE	800	GENERATEURS	828	KITS CARBURATEURS	845
THERMOSTAT	801	POMPE À EAU DE MER	828	POMPE D'EAU	846
<b>CUMMINS</b>	809	POMPE D'EAU	825	<b>SHERWOOD</b>	849
ALTERNATEUR	812	<b>PERKINS</b>	829	<b>JABSCO</b>	858
ANODES	812	ANODES	831	REF-->OEM	861
COLLECTEURS D'ÉCHAPPEMENT	809	DÉMARREUR	832	OEM-->REF	866
DÉMARREUR	812	ÉCHAPPEMENT	829		
POMPE À EAU DE MER	809	FILTRE	829		
SILENTBLOCK	809	POMPE À EAU DE MER	830		
<b>DETROIT DIESEL</b>	813	POMPE D'EAU	831		
ANODES	813				
COUDE D'ÉCHAPPEMENT	813				

FILTRO ACEITE

OIL FILTER

FILTRO OLIO

FILTE À HUILE

REF	OEM	
ALT023941	100-238-002	VELVET DRIVE Abierto   Open   Aperto   Ouvert
ALT340940	2001-238-001	VELVET DRIVE Cerrado   Closed   Chiuso   Fermé



ALT023941





ALT340940



DAMPER VELVET DRIVE

REF	OEM		Ø (mm)	
ALTDA-101	1004-650-001		352,30	26





REF	OEM		Ø (mm)	
ALTDA-108	1004-650-008	AS7-K2C - 370 CID	157,97	26





REF	OEM		Ø (mm)	
ALTDA-102	1004-650-002	AS4-K1C Volante delantero Forward flywheel Volano Anteriore Volant avant	157,97	26

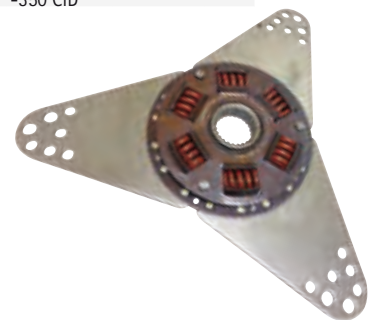

REF	OEM		Ø (mm)	
REC855694	1004-650-006	AS4-K2C -350 CID	169,16	26



REF	OEM		Ø (mm)	
ALTDA-107	1004-650-007	AS7-K2C - 430 CID	336,55	26





**KITS REPARACIÓN TRANSMISION**

**TRANSMISION REPAIR KIT**

**KIT RIPARAZIONE TRASMISSIONE**

**KIT RÉPARATION TRANSMISSION**

REF	OEM	
A/P2277	A4867HA	VELVET 71 & 72

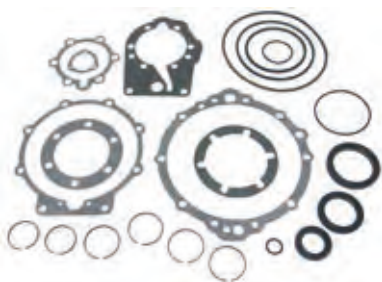

REF	OEM	
A/P2279	1308-410-001	V DRIVE



REF	OEM	
A/P2278		VELVET 71 & 72 Incluye discos Plates included Include dischi Comprend disques



**CATERPILLAR**

**COLECTORES**

**MANIFOLDS**

**COLLETTORI**

**COLLECTEURS**

REF	OEM	
REC8N2250	1W6586 8N2250	Para la mayoría motores 3208 For most engines 3208 Per la maggior parte dei motori 3208 Pour la majorité des moteurs 3208



**ENFRIADOR COMBUSTIBLE FUEL COOLER**

**SCAMBIATORE DE COMBUSTIBILE**

**REFROIDISSEUR D'ESSENCE**

REF	OEM	
REC300-0539	1W6586 8N2250	C32



**FILTRO ACEITE**

**OIL FILTER**

**FILTRO OLIO**

**FILTE À HUILE**

REF	OEM	
REC21707134	1R-0658	C32



REF	OEM	
REC847741	1R-0714	1 1/8" x 16 NPT







**BOMBAS ASPIRACIÓN DE AGUA MARINA**



**RAW MARINE WATER PUMPS**

**POMPE ASPIRAZIONE ACQUA MARNIA**



**POMPE À EAU DE MER**

REF	OEM			
SHEP176X	7E.4115 FP-7E4115 9Y-1304	Serie 3208	Ø 1 1/2"    Ø 1 3/4"	REC17000K





REF	OEM		
SHEG2902X	196-8895	C15 Et C18 Serie 3406E	REC29000K





REF	OEM		
SHEP1710C	4P-7168 7E-3268	Serie 3116 P1710C P1710C P172	REC17000K





REF	OEM	
REC7C3613	7C3613	Serie 3412





REF	OEM		
REC3N4851	3N4851	Serie 3406	JAB17370-0001





REF	OEM	
REC7C3614	7C3614	Serie 3508



REF	OEM		
SHEP1732C	170-6116 113-1109 152-8392	C7 / C7 Serie 3126 P1732C P1732A	REC17000K





REF	OEM		
REC5N9357	5N9357	Serie 3304, 3306	CEF500135









**new**

REF	OEM			BOMBA PUMP POMPA POMPE	PORTS
RECG2904X	123-0471 197-1328	C12 serie 3196	REC29000K	G2904X G1807 G18071	71,5 mm



**new**

REF	OEM			BOMBA PUMP POMPA POMPE	PORTS
RECG3001X	147-7850 212-7264 322-8594	C32 serie 3412	SHE30000K	G3001X	3-3/4

REF	OEM			PORTS
REC425-5421	425-5421 4255421	generators C1.5 & C2.2	REC21213660	3/4



**new**

KITS REPARACIÓN	REPAIR KITS	KIT RIPARAZIONE	KIT RÉPARATION																												
<table border="1"> <thead> <tr> <th>BOMBA PUMP POMPA POMPE</th> <th></th> <th>KIT MENOR KIT MINOR KIT MINOR KIT MINEUR</th> <th>KIT MAYOR KIT MAJOR KIT MAGGIORE KIT MAJEUR</th> </tr> </thead> <tbody> <tr> <td>SHEP176X</td> <td>SHE17000K</td> <td>SHE23973</td> <td>SHE23975</td> </tr> <tr> <td>SHEP1710C</td> <td>SHE17000K</td> <td>SHE25123</td> <td>SHE25121</td> </tr> <tr> <td>SHEG2902X</td> <td>SHE29000K</td> <td></td> <td>SHE25147</td> </tr> <tr> <td>SHEP1732C</td> <td>SHE17000K</td> <td>SHE25123</td> <td>SHE25121</td> </tr> <tr> <td></td> <td>SHE29000K</td> <td></td> <td>SHE25148</td> </tr> <tr> <td></td> <td>SHE30000K</td> <td>SHE25017</td> <td></td> </tr> </tbody> </table>	BOMBA PUMP POMPA POMPE		KIT MENOR KIT MINOR KIT MINOR KIT MINEUR	KIT MAYOR KIT MAJOR KIT MAGGIORE KIT MAJEUR	SHEP176X	SHE17000K	SHE23973	SHE23975	SHEP1710C	SHE17000K	SHE25123	SHE25121	SHEG2902X	SHE29000K		SHE25147	SHEP1732C	SHE17000K	SHE25123	SHE25121		SHE29000K		SHE25148		SHE30000K	SHE25017				 <p>SHE25148</p>
BOMBA PUMP POMPA POMPE		KIT MENOR KIT MINOR KIT MINOR KIT MINEUR	KIT MAYOR KIT MAJOR KIT MAGGIORE KIT MAJEUR																												
SHEP176X	SHE17000K	SHE23973	SHE23975																												
SHEP1710C	SHE17000K	SHE25123	SHE25121																												
SHEG2902X	SHE29000K		SHE25147																												
SHEP1732C	SHE17000K	SHE25123	SHE25121																												
	SHE29000K		SHE25148																												
	SHE30000K	SHE25017																													
 <p>SHE23973</p>	 <p>SHE25123</p>		 <p>SHE25017</p>																												
 <p>SHE23975</p>	 <p>SHE25121</p>		 <p>SHE25147</p>																												

**IMPULSORES      IMPELLER      GIRANTE      TURBINE**

OEM	PALAS BLADES PALE PALES	SHERWOOD	CEF	JOHNSON	JABSCO	RECMAR	A (mm)	B (mm)	C (mm)
3N1906	8		CEF500106GT	JOH09-1028B		REC3841697	14,29	65	50,2
3N5895	8		CEF500177GT		JAB17018-0001	REC3593573	14,29	65,2	75,65
1L4774	9		CEF500105T	JOH09-1029B		REC836-0001	22,5	96	63,1
7E3022	9				JAB18786-0001		25,4	118	88,9
3N8449	10	SHE22000K	CEF500179GX				23,8	114,3	109,5
7C3286	10		CEF500114T		JAB17937-0001-P		14,29	65	50,1
7E0321	12	SHE17000K	CEF500164T			REC17000K	20	84	73
1W5664									
1230492									
1095324	12		CEF500182G			REC18000K	20,7	94,5	20,7
1095327									
1237985									
4L8470	12		CEF500145T	JOH09-814B		REC875697	22,5	95	88,5
5N9360	12		CEF500135	JOH09-819B		REC21730344	22,5	95	63,1
3N4859	12		CEF500152		JAB17370-0001		25,4	95	88,9

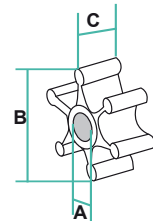

REC875697



REC21730344

REC17000K

REC3841697

REC3593573

REC836-0001

REC18000K

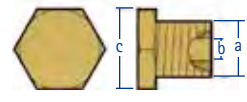

**ÁNODOS      ANODES      ANODI      ANODES**

KIT	KG	Ø (mm)	c (mm)	a (mm)
TENO2021/1T	0,03	35	9	14
TENO2021T	0,045	55	10	10
TENO2022T	0,145	20	22	16
TENO2023T	1,155	76	16	14
TENO2024T	0,135	63	16	14
TENO2026T	0,495	54	19	24
TENO2027T	0,06	40	12	11
TENO2028T	0,12	41	16	25
TENO2029BIS/T	0,04	38	10	22
TENO2029T	0,065	38	12,5	19







OEM	KG	L (mm)	L1 (mm)	Ø (mm)	b (mm)	c (mm)	a (mm)
TENO2020	0,03	26	9	14	12 mm		
TENO2021	6L2283	0,03	55	10	10	1/4" UNC	
	TENO2021TP	6L2282	0,015			1/4" UNC	10
							1/4" gas conic (bspt)
TENO2021/1	116-7011	0,015	35	10	9	1/4" UNC	
TENO2022	6L2016	0,065	20	10	22	5/8" UNC	
TENO2023	612289	0,105	76	13	16	3/8" UNC	
	TENO2023TP	0,040				3/8" UNC	14
							1/2" gas conic (bspt)
TENO2024	6L2288	0,09	63	13	16	3/8" UNC	
	TENO2024TP	0,040				3/8" UNC	14
							1/2" gas (bspp)
TENO2025	6L2284	0,035	33	12	14	5/16" UNC	
TENO2026	6L2286	0,242	54	20	19	3/4" UNC	
	TENO2026TP	0,280				3/4" UNC	24
							1 1/4" gas conic (bspt)
TENO2027	6L2280	0,033	40	10	12	3/8" UNC	
	TENO2027TP	6L2279	0,025			3/8" UNC	11
							3/8" gas conic (bspt)
TENO2028	7E5076	0,06	41	9	16	7/16" UNC	
	TENO2028TP	0,065				7/16" UNF	25
							1/2" gas conio (bspt)
TENO2029	642281	0,035	38	10	12,5	7/16" UNC	
TENO2029Bis	6L3104	0,02	38	10	10	1/14" UNC	
	TENO2029TP	6L2279G	0,03			7/16" UNF	19
							3/8" gas conic (bspt)







REF	OEM			Ø	
CM6L2016	6L2016	3/4"	1/2 x 13	22.26	20 mm
CME1	6L2280	3/8"	3/8 x 16	12.70	41 mm
CM6L2283	6L2283	1/4"	5/16 x 18	10.00	29 mm
CME8D	6L2284	1 1/4"	3/4 x 10	32.00	54 mm
CME-8	6L2285	1 1/4"	3/4 x 10	32.00	59 mm
CM6L2288	6L2288	1/2"	7/16 x 14	15.70	29 mm



## SILENTBLOCK

REF					
RECDF238-M1	820- 1000 kg 1800 - 2200 lbs	3/4" - 16	127 mm	Serie 3208 et 3304B (85-340 HP)	



REF					
RECDF4408-4	1130 - 1270 kg 2500 - 2800 lbs	1" - 14	127 mm	Serie 3208+	





## ALTERNADORES

## ALTERNATORS

## ALTERNATORI

## ALTERNATEUR

REF	OEM		
REC8HC2023K	796351	12V 90A	Para mayoría motores 3280 For most engines 3280 Per la maggior parte dei motori 3280 Pour la majorité 3280





## MOTORES DE ARRANQUE



## STARTERS

## MOTORINI AVVIAMENTO

## DÉMARREUR

REF	OEM			
REC128000-5720	128000-5720	12V 3.0kw	10	Para mayoría motores 3114 - 3116 For most engines 3114 - 3116 Per la maggior parte dei motori 3114 - 3116 Pour la majorité de moteurs 3114 - 3116



REF	OEM			
REC21323043	163-3361	12V 1.4kw	9	C2.2 Serie 3024C, 3024T



JUNTAS CULATA

CYLINDER HEAD GASKETS

GUARNIZIONE TESTATA

JOINT DE CULASSE

REF	OEM	
REC17030	16.50-00250	GM 305, 350 CID (5.0L / 5.7L)

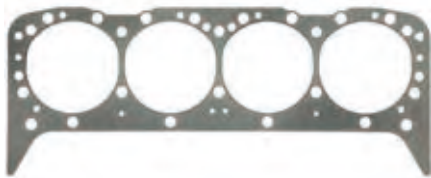

REF	OEM	
REC17046	16.50-00259	GM 454 CID (5.7L)



JUNTAS CODO

ELBOW GASKETS

GUARNIZIONE GOMITO

JOINT DE COUDE

REF	OEM
OSC0959	1650-05944



REF	OEM
BACC47-1650-06022	1650-056022



PROTECTOR SALIDA ESCAPE

EXHAUST PROTECTOR VALVE

PROTEZIONE SCARICO

PROTECTEUR SORTIE D'ÉCHAPPEMENT

REF	
REC34765A2	3"
REC12644A1	4"
REC89260	5" necesita 2 cortes de 45°
	5" requires two 45° cuts
	5" richiede due tagli a 45°
	5" nécessite 2 coupes à 45°
	6"



REC34765A2



REC12644A1



REC89260

BOMBAS AGUA

WATER PUMPS

POMPE ACQUA

POMPE D'EAU

REF	OEM	1" NPT	350 V8			KIT MENOR KIT MINOR KIT MINEUR	KIT MAYOR KIT MAJOR KIT MAGGIORE KIT MAJEUR
SHEG30-2B	16.80-18346					SHE23979	SHE12665



JUNTA BOMBA

WATER PUMP GASKETS

GUARNIZIONE POMPE ACQUA

JOINT DE POMPE

REF	OEM
REC27-34897	16.50-00078



**KITS REPARACIÓN      REPAIR KITS      KIT RIPARAZIONE      KIT RÉPARATION**

REF	OEM
SHE10077K	16.80-90047

REF	OEM
SHE10615K	16.80-90131

REF	OEM
SHE09959K	16.80-90166 16.80-90049

**BOMBAS COMBUSTIBLE      FUEL PUMPS      POMPE BENZINA      POMPE D'ESSENCE**

REF	OEM
REC86234A4	GM 4 & 6 cyl 153, 181, 250, 224, 225

**JUNTAS BOMBAS COMBUSTIBLE      FUEL PUMPS GASKETS      GUARNIZIONE POMPE BENZINA      JOINT POMPE D'ESSENCE**

REF	OEM
REC27-34898	16.50-005756

REF	OEM
REC27-34213	16.50-00074

**FILTRO ACEITE      OIL FILTER      FILTRO OLIO      FILTE À HUILE**

REF	OEM
REC35-06003	16.81-08746 GM 153, 181, 250 307G, 305K, 307K

REF	OEM
REC35-06007	1R-16.81-06536 Ford 302,351

REF	OEM	
REC3850559	GM +283, 305, 307, 350, 454	



**CARBURADORES      CARBURETORS      CARBURATORI      CARBURATEURS**

**KITS      KIT      KIT      KIT**

REF	OEM
REC823426A1	45334

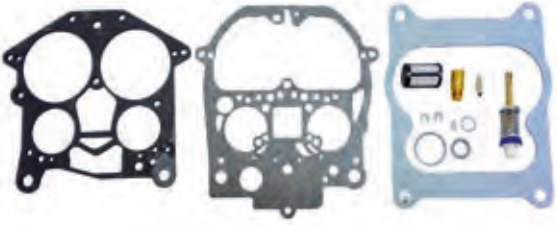

REF	OEM
REC823427A1	



**BOYAS      FLOATS      GALLEGIANTI      FLOTEURS**

REF	OEM
REC1397-3327	



REF	OEM
REC1397-2060	



**TUBO COMBUSTIBLE BOMBA --> CARBURADOR      FUEL TUBE PUMP --> CARBURETOR      TUBO CARBURANTE POMPA --> CARBURATORE      DURITE CARBURANT POMPE --> CARBURATEUR**

REF	
REC18-8114	3/8" X 31" PTFE - 5/8"
REC18-8115	3/8" X 25" PTFE - 5/8"



**ENCENDIDO      IGNITON      ACCENSIONE      ALLUMAGE**

**TAPAS DISTRIBUIDOR      DISTRIBUTOR CAPS      CALOTTE SPINTEROGENI      TÊTES D'ALLUMEUR**

REF	OEM	
REC392-9766	45334      PRESTOLITE V8	Con tornillo Screw on con vite Avec vis



REF	OEM	
REC835702	18-5399      PRESTOLITE V8	



REF	OEM
REC33765T	DELCO



REF	OEM	
REC982209	16.69-00148      MALLORY V8	





REF	OEM	
REC12532	16.69-00100 F16900165	MALLORY V8 Tapa plana Flat cap Calotta piatta Tête plane



REF	OEM	
REC393-9459Q1	16.69-00052	DELCO



PLATINO	POINT	PUNTINE	VIS PLATINÉES
---------	-------	---------	---------------

REF	
REC8M6001219	



REF	OEM	
REC391-5090	16.69-00039	



REF	OEM	
REC34235T	16.69-00049	



CONDENSADORES	CONDENSERS	CONDENSATORE	CONDENSEURS
---------------	------------	--------------	-------------

REF	OEM	
REC8M6001217	16.69-00040	



REF		
REC8M6001249		



REF	OEM	
REC33662	41057 16.69-00050	



REF		
REC33706		



REF	OEM	
REC64851	1869704	



ROTORES	ROTORS	ROTORI	DOIGT D'ALLUMEUR
---------	--------	--------	------------------

REF		
REC3853801		



REF	OEM	
REC89825302	16.69-00149	



REF		
REC834975		



REF	OEM	
REC841243	16.69-00042	



REF	OEM	
REC58217	16.69-00051	





**BOBINAS DE ENCENDIDO IGNITION COIL**

REF	OEM	
REC1463-9382	37068 51080	Resistencia externa. Utilizar con encendido convencional. External resistor. Use with conventional ignition Resistenza esterna. Utilizzare con accensione convenzionale Résistance externe. A utiliser avec un allumage conventionnel.

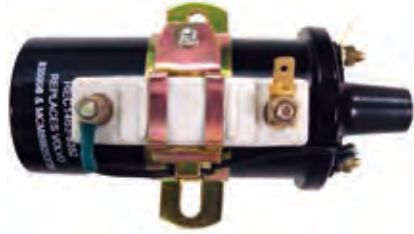

**BOBINE ACCENSIONE**

**BOBINE D'ALLUMAGE**

REF	
REC300-00879	No usa resistencia externa. Utilizar con encendido Prestolite. Use without external resistor & Prestolite ignition Non utilizza resistenza esterna. Utilizzare con spinterogeno Prestolite N'utilise pas de résistance externe. A utiliser avec l'allumage Prestolite.



**MOTOR DE ARRANQUE STARTER**

**MOTORINO D'AVVIAMENTO DÉMARREUR**

REF	OEM	⚡	☀️	
REC50-99417A2	16.61-0042 16.61-0043	12V	9	4 en línea. (Tornillos en misma altura) 4 in line. (In line mounting holes) 4 in rete. (viti di supporto parallele) 4 en ligne. (Vis de montage parallèle)



**CRUSADER**

**JUNTAS CULATA**

**CYLINDER HEAD GASKETS**

**GUARNIZIONE TESTATA**

**JOINT DE CULASSE**

REF	OEM
REC17010	33408

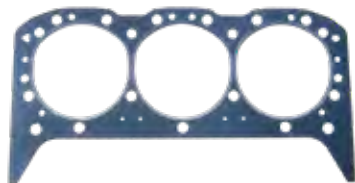

REF	OEM	🔧
REC17042	31136	454 (7.4L) CID GEN V

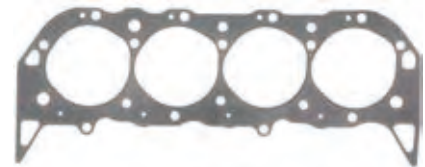

REF	OEM	🔧
REC17048	31137	502 (8.2L) CID 7.4L

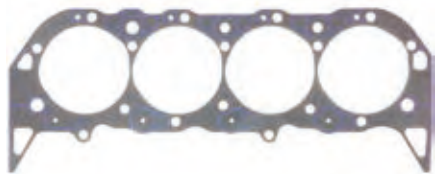

REF	OEM	🔧
REC17040	30266	GM 454 (7.4L) CID

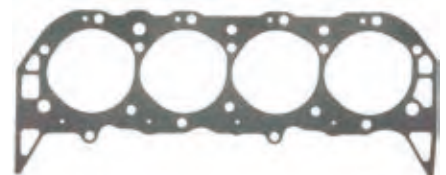

REF	OEM	🔧
REC17030	7057500	GM305 (5.0L) 350 (5.7L) CID



JUNTAS TAPA BALANCINES VALVE COVER GASKETS

REF	OEM	
REC17920	97686	262 CID



GUARNIZIONE COPERCHIO PUNTERIE JOINT CACHE CULBUTEUR PUNTERIE

REF	OEM	
REC17930	91351	V8



JUNTAS ADMISIÓN INTAKE GASKETS

REF	OEM	
REC17310	33393	222 CID

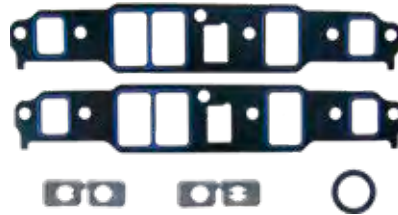

GUARNIZIONE ASPIRAZIONE

JOINT ADMISSION

JUNTAS TAPA CADENA DISTRIBUCION

REF	OEM
REC27-14250	20129

TIMING CHAIN COVER GASKETS



GUARNIZIONE CATENA CARTER DISTRIBUZIONE

JOINT CARTER DE DISTRIBUTION

COLECTORES ESCAPE

EXHAUST MANIFOLDS

COLLETTORI SCARICO

COLLECTEUR D'ÉCHAPPEMENT

GM SMALL BLOCK V8 5.0 & 5.7L, 220, 270

REF	OEM		KIT	
HOT20925	97752 96120	Estribor Stbd Tribordo Tribord	HOT20775-MK	5.0 & 5.7L, 220, 270
HOT20926	97753 96121	Babor Port Babordo Babord		



HOT20775-MK



GM BIG BLOCK V8 7.4L & 8.2L, 454XL

REF	OEM		KIT	
HOT20929	97992 97114	Estribor Stbd Tribordo Tribord	HOT20799-MK	7.4 & 8.2L
HOT20933	97993 97115	Babor Port Babordo Babord		



HOT20799-MK



**GM SMALL BLOCK V8 5.0 & 5.7L, CM305, CM350XL & CM350HT**

REF	OEM	KIT	
HOT20982	98125	HOT20982-MK	7.4 & 8.2L 454XL & 502XL



**GM BIG BLOCK V8 7.4 & 8.2L, 454XL & 502XL**

REF	OEM	KIT	
REC98243	98243	OSC8243-MK	7.4 & 8.2L 454XL & 502XL

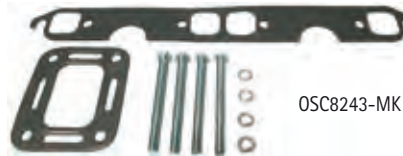

**JUNTAS COLECTOR ESCAPE**

**EXHAUST MANIFOLD GASKETS**

**GUARNIZIONE COLLETTORI CARICO**

**JOINT COLLECTEUR D'ÉCHAPPEMENT**

REF	OEM	
REC27-33395	96306	



REF	OEM	
REC27-99757	97498	GM V6



REF	OEM	COLL.	
REC3852455		HOT20998	



**CODOS, SUPLEMENTOS Y KITS**

**ELBOWS, RISERS & KITS**

**GOMITI, DISTANZIALI E KIT**

**COUDES ET KIS**

**GM SMALL BLOCK V8 5.0 & 5.7L, CM305, CM350XL & CM350HT  
GM BIG BLOCK V8 7.4 & 8.2L, 454XL & 502XL**

REF	OEM	KIT	JUNTA	
HOT20938	98126	HOT20982-MK	OSC9015G	V8. 283, 305, 307, 327 & 350



HOT20982-MK



OSC9015G



REF	OEM	KIT	
HOT30984	98128	OSC8128-MK HOT30984-MK	V8 283, 305, 307, 327 & 350

**SUPLEMENTO 4"**  
**4" RISER**  
**PROLUNGA 4"**  
**SUPPLÉMENT 4"**



**GM SMALL BLOCK V8 5.0 & 5.7L, 220, 270**  
**GM BIG BLOCK V8 7.4L & 8.2L, 454XL**

REF	OEM	KIT	
HOT20934	98068 96560	HOT26562-MK	3"



REF	OEM	KIT		OEM	
HOT20928	97924	HOT26562-MK	4"	V6 - V8	96562



**CODO ESCAPE GIRATORIO**  
**EXHUST ELBOW SWIVEL**  
**GOMITO SCARICO GIRATORIO**  
**COUDE D'ÉCHAPPEMENT PIVOTANT**

REF	OEM	
OSC7387	97387	3"
OSC7624	97624	4"



REF	OEM	KIT
HOT20918	97386	HOT26562-MK

Codo revestido  
 Jacketed elbow  
 Gomito rivestito  
 Coude recouvert



REF	OEM	CODO ELBOW GOMITO COUDE	
REC96562		HOT20918	V6-V8
HOT26562-MK	96562		



HOT26562-MK



REC96562

REF	OEM	KIT
HOT20916	97169	OSC7169-MK HOT20916-MK

**SUPLEMENTO ESCAPE 8"**  
**8" EXHAUST RISER**  
**PROLUNGA SCARICO 8"**  
**SUPPLÉMENT 8"**

OSC7169-MK  
 HOT20916-MK



REF	OEM	KIT
HOT20927	97772	OSC7772-MK HOT20927-MK

**SUPLEMENTO ESCAPE 4"**  
**4" EXHAUST RISER**  
**PROLUNGA SCARICO 4"**  
**SUPPLÉMENT 4"**

OSC7772-MK  
 HOT20927-MK



**PROTECTOR SALIDA ESCAPE**

**EXHAUST PROTECTOR VALVE**

**PROTEZIONE SCARICO**

**PROTECTEUR DE SORTIE D'ÉCHAPPEMENT**

REF	
REC34765A2	3"
REC12644A1	4"
REC89260	5" necesita 2 cortes de 45°
	5" requires two 45° cuts
	5" richiede due tagli a 45°
	5" nécessite 2 coupes à 45°
	6"



REC34765A2



REC12644A1



REC89260

**BOMBA CIRCULACIÓN DE BLOQUE**

**BLOCK CIRCULATING PUMP**

**POMPA DI RICIRCOLO DI BLOCCO**

**POMPE DE BRASSAGE**

REF	OEM	
REC46-8M0113735		Bidireccional. Para bloques GM grandes con tapa del distribuidor de acero estampado.
	67859	Bi-directional. For big block GM engines with stamped steel timing covers.
	17670	Bidirezionale. Per motori GM di grandi dimensioni con coperchi di distribuzione in acciaio stampato.
	811573	Bidireccional. Para bloques GM grandes con tapa del distribuidor de acero estampado.
	30103	Bidireccional. Para bloques GM grandes con tapa del distribuidor de acero estampado.



REF	OEM	
REC46-8M0113734	20318	GM V-6 y V8 de bloque pequeño.
	7142520	GM V-6 & small blocks V8 engines.
		GM V-6 e piccoli blocchi V8 motori V-6 GM et V8 à petit bloc.



REF	
REC3853796	Bidireccional. Bi-directional. Bidirezionale. Bidireccional. Bidireccional.



**BOMBA ASPIRACIÓN AGUA MARINA**

**RAW MARINE WATER PUMP**

**POMPA ASPIRAZIONE ACQUA MARINA**

**POMPE À EAU DE MER**

REF	OEM	KIT			
SHEE35	97179	SHE11068	1" NPT	REC10615K	220, 270, 300 & 350



REF	OEM				BOMBA PUMP POMPA POMPE
RECP1014 SHEP1014	40050 RA057031	1-1/4" NPT	REC10615K	220, 270, 300, 350 & 545	P1014



REF	OEM	
REC3860703	40070	V6 & V8





**COJINETE BOMBA SHERWOOD**

**BEARING SHERWOOD PUMP**

**CUSCINETTO POMPA SHERWOOD**

**ROULEMENT POMPE SHERWOOD**

REF	OEM
SHE4257	20292



**KITS BOMBA SHERWOOD**

**KIT SHERWOOD PUMP**

**KIT POMPA SHERWOOD**

**KIT POMPE SHERWOOD**

REF	OEM
SHE09959K	1003026

Ø 27/16"  
Lat. 1 1/4"



REF	OEM
CEF500103T	1003062
	1003026
	22212

Ø 27/16"  
Lat. 1 1/4"



REF	OEM
REC10615K	20300
SHE10615K	20310
CEF500120T	R061017



REF	OEM
REC3854286	1003026
	22212
REC10077K	727103



**KITS RETÉN**

**KIT SEAL**

**KIT PARAOLIO**

**KIT JOINT**

REF	OEM
SHE10927	20309



REF	OEM
SHE12859	40057



**RACORD MANGUERA CODO**

**WATER FITTING**

**RACCORDO TUBO GOMITO**

**RACCORD TUYAU-COUDE**

REF	
REC18-8112	1 1/4"



**BOMBAS COMBUSTIBLE**

**FUEL PUMP**

**POMPA BENZINA**

**POMPE ESSENCE**

REF	OEM	
REC3855276	981650	GM V8, 305, 307, 350, 400 (5.25 - 6.5 PSI)



REF	OEM	
REC62092T	982063	FORD V8, 302







TERMOSTATO	THERMOSTAT	TERMOSTATO	THERMOSTAT
------------	------------	------------	------------

REF	OEM	
REC76270T	96358	70° C

Sólo para circuitos Agua dulce  
Thermostat for fresh water cooling only  
Solo per circuiti ad acqua dolce  
Pour les circuits d'eau douce uniquement



REF	OEM	
REC8M0091470	97895	70° C

Sólo para circuitos Agua dulce  
Thermostat for fresh water cooling only  
Solo per circuiti ad acqua dolce  
Pour les circuits d'eau douce uniquement



REF	OEM	
REC97361	97361	70° C



FILTRO	FILTER	FILTRO	FILTRE
--------	--------	--------	--------

<b>FILTRO SEPARADOR DE AGUA</b>	<b>WATER SEPARATING FUEL FILTER</b>	<b>FILTRO SEPARATORE ACQUA-BENZINA</b>	<b>FILTRE D'ESSENCE</b>
---------------------------------	-------------------------------------	--	-------------------------

REF	OEM
REC35-8M0061975	98041



FILTRO COMBUSTIBLE	FUEL FILTER	FILTRO BENZINA	FILTRE D'ESSENCE
--------------------	-------------	----------------	------------------

REF	OEM
REC982230	91606



FILTRO ACEITE	OIL FILTER	FILTRO OLIO	FILTRE D'HUILE
---------------	------------	-------------	----------------

REF	OEM	
REC35-06003	201104	GM + SS330 Remote Mount





REF	OEM	
REC3850559	201104	GM + SS330 Remote Mount



REF	OEM	
REC35-06007	9002514	FORD



REF	OEM	
REC3517857	220, 300, 320, 325	Remote Mount



RECAMBIO PARA CARBURADORES ROCHESTER 2 & 4 BBL

ELEMENT FOR ROCHESTER 2 & 4 BBL CARBURETORS

CARTUCCIA PER CARBURATORI ROCHESTER 2 E 4 BBL

FILTRE D'ESSENCE POUR CARBURATEURS ROCHESTER 2 ET 4 BBL

REF  
REC93568



CARBURADORES

CARBURETORS

CARBURATORI

CARBURATEURS

KITS

KIT

KIT

KIT

REF  
REC841994

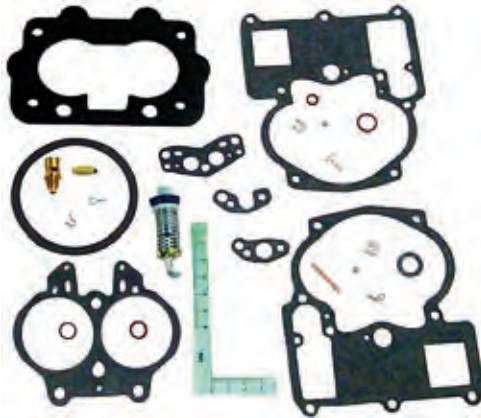

REF  
REC823427A1



REF  
REC823426A1

OEM  
45334



GUIA KITS CARBURADORES

CARBURETORS KITS APPLICATION

GUIDA KIT CARBURATORE

GUIDA KITS CARBURATEURS

CYL	CODE	MOD.	CARB.	KIT	
4"	153" 2.5L	R-2	2GC 7025082 7028086	REC823427A1	REC1397-2060
6"	225" 3.7L	R-2	2GC 7025181	REC823427A1	
8"	283" 4.6L 327" 5.3L	R-2	2GC 7024185	REC823427A1	
8"	305" 5.0L	R-2	5GV 17057134	REC841994	REC3302-9031
8"	350" 5.7L 454" 7.4L	R-4	4MV 17059293 17082403 7027081 7028282	REC823426A1	REC1397-3327
8"	427" 7.0L	R-4	4MV 7027081 7028282	REC823426A1	REC1397-3327

TUBO COMBUSTIBLE BOMBA --> CARBURADOR

FUEL TUBE PUMP --> CARBURETOR

































TUBO CARBURANTE POMPA --> CARBURATORE

DURITE CARBURANT POMPE --> CARBURATEUR

REF  
REC18-8114 3/8" X 31" PTFE - 5/8"  
REC18-8115 3/8" X 25" PTFE - 5/8"



BOYAS		FLOATS		GALLEGIANTI		FLOTEURS	
REF	OEM			REF	OEM		
REC1397-3327				REC1397-2060	45303		
REF	OEM						
REC3302-9031							
APAGALLAMAS		FLAME ARRESTORS		PARAFIAMMA		ARRÊTEURS DE FLAMMES	
REF	OEM			REF	OEM		
REC85785A2	97595 97214	V-8		REC805298A1	33628	Hi-Performance	
SENSORES		SENSORS		SENSORI		CAPTEURS	
TEMPERATURA ACEITE		OIL TEMPERATURE		TEMPERATURA OLIO		TEMPÉRATURE D'HUILE	
REF	OEM		TERMINAL				
REC8M0068784	700425	1/8 -27	10-31				
TEMPERATURA AGUA		WATER TEMPERATURE		TEMPERATURA ACQUA		TEMPÉRATURE D'EAU	
REF	OEM						
REC97258A1	700427	1/2"-14NPT					
TPS							
REF	OEM						
REC8M0125617	47032						
IAC							
REF	OEM						
REC3855194	47033						
TEMPERATURA ENFRIADOR		COOLER TEMPERATURE		TEMPERATURA SCAMBIATORE		TEMPÉRATURE REFFROIDISSEUR	
REF	OEM						
REC3850397	47002						

ENCENDIDO	IGNITON	ACCENSIONE	DÉMARRAGE												
TAPAS DISTRIBUIDOR	DISTRIBUTOR CAPS	ALOTTE SPINTEROGENI	TÊTE D'ALLUMEUR												
<table border="1"> <tr> <th>REF</th> <th>OEM</th> <th></th> </tr> <tr> <td>REC392-9766</td> <td>41076</td> <td>PRESTOLITE V8</td> </tr> </table> <p>Con tornillo Screw on con vite Avec vis</p>	REF	OEM		REC392-9766	41076	PRESTOLITE V8		<table border="1"> <tr> <th>REF</th> <th>OEM</th> <th></th> </tr> <tr> <td>REC835702</td> <td>41052</td> <td>PRESTOLITE V8 CLIP</td> </tr> </table>	REF	OEM		REC835702	41052	PRESTOLITE V8 CLIP	
REF	OEM														
REC392-9766	41076	PRESTOLITE V8													
REF	OEM														
REC835702	41052	PRESTOLITE V8 CLIP													
<table border="1"> <tr> <th>REF</th> <th>OEM</th> <th></th> </tr> <tr> <td>REC33765T</td> <td>DELCO</td> <td></td> </tr> </table>	REF	OEM		REC33765T	DELCO			<table border="1"> <tr> <th>REF</th> <th>OEM</th> <th>MALLORY V8</th> </tr> <tr> <td>REC982209</td> <td>20222</td> <td></td> </tr> </table>	REF	OEM	MALLORY V8	REC982209	20222		
REF	OEM														
REC33765T	DELCO														
REF	OEM	MALLORY V8													
REC982209	20222														
<table border="1"> <tr> <th>REF</th> <th>OEM</th> <th></th> </tr> <tr> <td>REC12532</td> <td>16.69-00100 FI6900165</td> <td>MALLORY V8</td> </tr> </table> <p>Tapa plana Flat cap Calotta piatta Tête plane</p>	REF	OEM		REC12532	16.69-00100 FI6900165	MALLORY V8		<table border="1"> <tr> <th>REF</th> <th>OEM</th> </tr> <tr> <td>REC3854260</td> <td>4 cyl</td> </tr> </table>	REF	OEM	REC3854260	4 cyl			
REF	OEM														
REC12532	16.69-00100 FI6900165	MALLORY V8													
REF	OEM														
REC3854260	4 cyl														
<table border="1"> <tr> <th>REF</th> <th>OEM</th> <th></th> </tr> <tr> <td>REC3854331</td> <td>DELCO V6</td> <td></td> </tr> </table> <p>Encendido electrónico Electronic ignition Accessione elettronico Allumage électronique</p>	REF	OEM		REC3854331	DELCO V6			<table border="1"> <tr> <th>REF</th> <th>OEM</th> <th></th> </tr> <tr> <td>REC3854548</td> <td>38070</td> <td>DELCO V8</td> </tr> </table> <p>Encendido electrónico Electronic ignition Accessione elettronico Allumage électronique</p>	REF	OEM		REC3854548	38070	DELCO V8	
REF	OEM														
REC3854331	DELCO V6														
REF	OEM														
REC3854548	38070	DELCO V8													
<table border="1"> <tr> <th>REF</th> <th>OEM</th> <th></th> </tr> <tr> <td>REC392-9086T</td> <td>41069</td> <td>PRESTOLITE V6</td> </tr> </table>	REF	OEM		REC392-9086T	41069	PRESTOLITE V6		<table border="1"> <tr> <th>REF</th> <th>OEM</th> <th>V8</th> </tr> <tr> <td>REC33708</td> <td>12528</td> <td></td> </tr> </table>	REF	OEM	V8	REC33708	12528		
REF	OEM														
REC392-9086T	41069	PRESTOLITE V6													
REF	OEM	V8													
REC33708	12528														
<table border="1"> <tr> <th>REF</th> <th>OEM</th> </tr> <tr> <td>REC393-4988</td> <td>3000121</td> </tr> </table>	REF	OEM	REC393-4988	3000121											
REF	OEM														
REC393-4988	3000121														



PLATINO	POINT	PUNTINE	VIS PLATINÉES
REF REC34235T		REF OEM REC391-5090 20117	
REF OEM REC8M6001219 41058		REF OEM REC58033 3000124	
CONDENSADORES	CONDENSERS	CONDENSATORE	CONDENSEURS
REF OEM REC8M6001217 12530		REF REC8M6001249	
REF OEM REC33662 41057 705787		REF OEM REC33706 12526	
ROTORES	ROTOR	ROTORI	DOIGTS D'ALLUMEUR
REF OEM REC3853801 41089 41074		REF OEM REC65864 3000122	
REF OEM REC834975 41059		REF OEM REC3854261 3854261	
REF OEM REC89825302 20223		REF OEM REC3854311 20223	
REF OEM REC841243 12531 1003318		REF OEM REC3854549 38071	
REF REC58217		REF OEM DELCO V6	
		REF OEM V8	

KITS		KIT		KIT		KIT	
REF REC3423A1		REF REC391-5090Q1	Mallory 8 cyl. 	REF REC392-6325Q1	V8 Prestolite Clip 	REF REC392-6324Q1	Prestolite V6 Et V8 
DISTRIBUIDOR		DISTRIBUIDOR		SPINTEROGENI		ALLUMEURS	
REF REC17177A1	OEM 37061	MALLORY GM V8 	REF REC807964A1	V6 	REF REC392-6316	MALLORY YL512CV Ford 302 CID V8 	KIT REC391-5090Q1
REF REC805222A1	OEM RA107039E	V8 262, 454, 502 except 384/409 	REF REC817377	181 RX Delco est ignition 			

**KITS CONVERSIÓN  
ELECTRÓNICO**

**ELECTRONIC  
CONVERSION KIT**

**KIT CONVERSIONE  
ELETTRONICO**

**KIT, CONVESION  
ELECTRONIQUE**

REF



REC26904

Mallory YL o YD con rotación reloj y contrareloj. 8 cyl.  
For most Mallory V8 distributors  
8 cilindri Mallory YL o YD con rotazione oraria e antioraria  
Mallory YL ou YD avec rotation dans le sens des aiguilles  
d'une montre et dans le sens inverse. 8 cyl.



REF

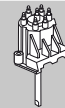

REC26905

Para la mayoría de distribuidores Prestolite V8 con tornillo en la tapa  
For most Prestolite V8 distributors with screw on cap  
Per al maggior parte degli spinterogeni Prestolite V8 con vite nella calotta.  
Pour la plupart des distributeurs Prestolite V8 avec couvercle à vis



REF



REC26901

Delco 6 cyl.



**BOBINAS DE ENCENDIDO**

**IGNITION COIL**

**BOBINE ACCENSIONE**

**BOBINES D'ALLUMAGE**

REF

OEM



REC3854002

7243200

4 cyl V8  
3.0L (1991+)  
5.7 & 7.4 efi (1995+)



REF

OEM



REC3854161

3854161

FORD



REF

REC1463-9382

37068  
51080

Resistencia externa.  
Utilizar con encendido convencional.  
External resistor. Use with conventional ignition  
Resistenza esterna. Utilizzare con accensione  
convenzionale  
Résistance externe. A utiliser avec un allumage  
conventionnel.

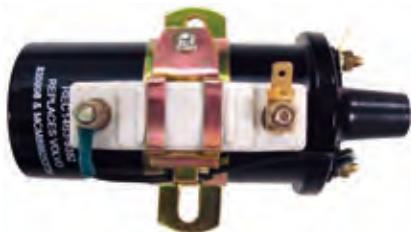

REF

REC300-00879

No usa resistencia externa.  
Utilizar con encendido Prestolite.  
Use without external resistor & Prestolite ignition  
Non utilizza resistenza esterna. Utilizzare con spinterogeno  
Prestolite  
N'utilise pas de résistance externe. A utiliser avec l'allumage  
Prestolite.



REF

REC3854001



REF

OEM



REC3854003

7243110

4, 6, 8 cyl



**JUEGOS DE CABLES, ALTO RENDIMIENTO**

Núcleo del cable de Kevlar de 8 mm antimagnético. Funda de silicona amarilla. Terminales bujías con muelle de acero inox. Terminal del distribuidor de cobre. Terminales bobina. Silicona resistente a altas temperaturas. Garantía de 5 años.

**HD SPARK PLUG WIRE SET**

Antimagnetic. Kevlar core. Yellow silicone boot Et jacket. SS snaplock. Brass distributor terminal. Coil terminals. High resistant silicone. 5 year warranty.

**KIT CAVI CANDELE, ALTE PRESTAZIONI**

Nucleo del cavo di Kevlar da 8 mm antimagnetico. Copertura di silicone gialla. Terminali candele con molle di acciaio inox. Terminale lato spinterogeno in rame. Terminale Bobine. Silicone resistente alle alte temperature. Garanzia di 5 anni.

**KIT FAISCEAU DE BOUGIE**

Noyau en Kevlar antimagnétique. Gaine en silicone jaune. Bornes de bougie d'allumage avec ressort en acier inoxydable. Terminal de distribution en laiton. Bornes de bobine. Silicone haute résistance. Garantie de 5 ans.

1	Camisa de silicona de 8 mm	8 mm silicone jacket	Rivestimento in silicone da 8 mm	Gaine silicone de 8mm
2	Látex resistente altas temperaturas	Heat resistant latex	Latex resistente alle alte temperature	Latex résistant à haute température
3	Acero inox	Stainless Steel	Acciaio inox	Acier inox
4	Núcleo de Kevlar	Kevlar core	Nucleo de Kevlar	Noyau de Kevlar
5	Capuchón de silicona	Silicone jacket	Rivestimento in silicone	Capuchon en silicone
6	Trenzado especial fibra de vidrio	Fiberglass braiding	Fibra di vetro	Tresse en fibre de verre
7	Terminal de acero inox	Stainless Steel terminal	Terminale di acciaio inox	Terminal en acier inox

	ARRANQUE IGNITION AVVIAMENTO DEMARRAGE				SERIE XL	REF
	CYL	CONVEN.	ELECT.			
262/4.3L	6	✓				REC15-604
262/4.3L	6		✓			REC15-601
305/5.0L	8	✓				REC15-801
350/5.7L	6	✓				REC15-801
350/5.7L	8		✓			REC15-805
454/7.4L	8	✓				REC15-801
454/5.7L	8			✓		MAG15-803
502/8.2L	8	✓				REC15-801
502/8.2L	8			✓		MAG15-803

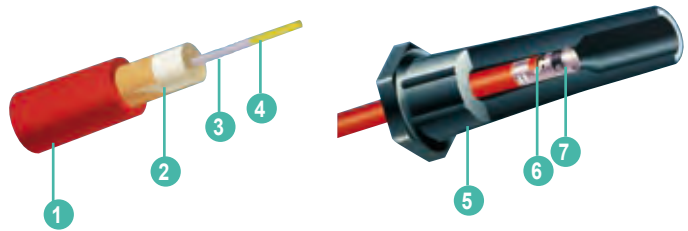

**MOTORES DE ARRANQUE STARTERS**

**MOTORINI AVVIAMENTO DÉMARREURS**

REF	OEM	⚡	☀️	🔧	
REC50-97499A2	42090 RA122008 1109484 19010617	12V 1.4kW	9		170, 185, 200, 225, 230, 283, 305, 307, 327, 348, 350, 364, 409, 427, 454, 496



REF	OEM	⚡	🔧	☀️	
REC50-808011A05	42091 RA122009 1109485 9000888 19010615	12V 1.4 kW		9	Contrarrotación o montaje en campana CCW Starter Controrotante o montato nella campana Contre-rotation ou montage sur capot



REF	OEM	⚡	🔧	☀️	
REC50-863007A1	RA122015	12V 1.4 kW	496	11	



REF	OEM	⚡	🔧	☀️	
REC50-99418A2	1109482	12V	262, 454	9	





COLECTORES ESCAPE

EXHAUST MANIFOLDS





COLLETTORI SCARICO

COLLECTEUR D'ÉCHAPPEMENT

REF	OEM	
REC3922122	3922122 4020066 4019951	6B, 6BT & 6BTA



SILENTBLOCK

REF					
RECDF477-M-3	430 - 900 kg 950 - 2000 lbs	3/4"	127 mm	3.9L 4 cil. 5.9L 6 cil.	80 - 370 hp







BOMBA ASPIRACIÓN AGUA MARINA

RAW MARINE WATER PUMP

POMPA ASPIRAZIONE ACQUA MARINA

POMPE À EAU DE MER

REF	OEM				
DJC0819 SHEP1722C	3912139 3922589	Ø 2"	Ø 1 3/4"	REC17000K	6B & 6C 270-450 HP (8.3L)







new



REF	OEM					
RECP1722C	3912139 3922589 3964989	2"	1-3/4"	REC17000K	6CTA 8.3	P1722C

BOMBA PUMP  
POMPA POMPE





REF	OEM				
DJC0820 SHEM71	3912019 3010336 3278137 3907458	Ø 1/4"	Ø 1/4"	REC10615K	4 cyl B Series 210 HP (3.9L) 4B 4BT3.9 6BT5.9



REF	OEM				
DJC004	3010336 3278137	Ø 1/2"	Ø 1/2"	CEF500135	NH220 NH250 V555 NT855



REF	OEM		
SHEG2603X	3967246 3922589	SHE26000K	QSC & QSM11 QSC & QSB

Codos no incluidos  
Elbows not included  
Gomito non incluso  
No comprend coudes







REF	OEM		
SHEG2903X	4929178 3349392 5260393	SHE29000K	QSM11

Codos no incluidos  
Elbows not included  
Gomito non incluso  
No comprend coudes



REF	OEM		
DJC1730 SHEP1730C	3866493 3897194	REC17000K	6CTA 8.3M 6CTA 5.9 (270 - 450 HP) (5.9 & 8.3L) Codos con brida Flanged Elbows Gomiti con fascetta avec collier







REF	OEM				
DJC0830 SHEGC1	3912962	Ø 1 1/2"	Ø 1 1/2"	REC15000K	6Et 4B Series 250 HP



REF	OEM				
DJC2701	3922589	Ø 1/2"	Ø 1/2"	REC17000K	QSB5.9 QSB6.9





Se suministra sin conexiones ni piñón delantero.  
It is supplied without connections or front pinion.  
Viene fornito senza connessioni o pignone anteriore.  
Livré sans raccords ni pignon avant.





REF	OEM					
RECP1716C SHEP1716C	3919899 3922590	2"	1-3/4"	REC17000K	6B	P1716C

**new**



REF	OEM				
SHEGC5	39127684	Ø 1 1/2"	Ø 1 1/2"	REC15000K	6B Series 250 HP



REF		
SHEP2708X	SHE27000K	QSC



Codos no incluidos  
Elbows not included  
Gomito non incluso  
No comprend coudes



REF	OEM		
SHEP1727C	3897194	REC17000K	6B Et 6C 270-450 HP 8.3L

Codos con brida  
Flanged Elbows  
Gomiti con fascetta  
Coudes avec collier



REF	OEM		
SHEP1016	854179001 879312023	SHE10615K	CMD 2.8 EI, ES (170/200) CMD QSD 2.8 EI, ES (170/210/220/230) CMD QSD 2.0 EI, ES (115/130/150)



**KITS REPARACIÓN**

**REPAIR KITS**

**KIT RIPARAZIONE**

**KIT RÉPARATION**

BOMBA PUMP POMPA POMPE		KIT MENOR KIT MINOR KIT MINEUR	KIT MAYOR KIT MAJOR KIT MAGGIORE KIT MAJEUR
DJC004	CEF500135		
DJC0819	REC17000K		
DJC0820	REC10615K		
DJC0830	REC15000K		
DJC1730	REC17000K		
DJC2701	REC17000K		
SHEGC1	SHE15000K	SHE23980	SHE23981
SHEGC5	SHE15000K	SHE23980	SHE23981
SHEG2603X	SHE26000K	SHE24841	SHE24842
SHEG2903X	SHE29000K	SHE25044	SHE25045
SHEM71	SHE10615K	SHE23976	SHE23977
SHEP1016	SHE10615K		
SHEP1716C	SHE17000K	SHE25124	SHE25122
SHEP1722C	SHE17000K	SHE25124	SHE25122
SHEP1727C	SHE17000K	SHE25124	SHE25122
SHEP1730C	SHE17000K	SHE25124	SHE25122
SHEP2708X	SHE27000K	SHE25125	SHE25126



SHE23980



SHE23981



SHE24841



SHE24842



SHE25044



SHE25045



SHE23976



SHE23977



SHE25124



SHE25125



SHE25122



SHE25126

**IMPULSORES**

**IMPELLER**

**GIRANTE**

**TURBINE**

OEM	PALAS BLADES PALE PALES	SHERWOOD	CEF	RECMAR	A (mm)	B (mm)	C (mm)
3802444							
3897337	12	SHE17000K	CEF500164T	REC17000K	20,1	84	73,5
3916852							
3925236							
3349198	12	SHE15000K	CEF500167	REC15000K	16	65	51,2
3916720							
3908220	12	SHE10615K	CEF500120T	REC10615K	15,9	65,2	41,3
3972366	12	SHE26000K	CEF500183G		20	94,5	79,8
3974456	12	SHE27000K	CEF500181G	REC27000K	16,1	84	73
	12	SHE29000K	CEF500192GX	REC29000K	20	94,5	101,5
4019403							
4933743	12	SHE18000K	CEF500182G	REC18000K	20,7	94,5	101,5

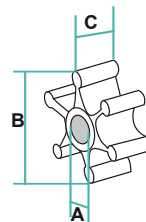

REC17000K



REC15000K



REC10615K



REC27000K



REC29000K



REC18000K



ÁNODOS ANODES ANODI ANODES

REF	KG		Ø	c (mm)	a (mm)	
TEN02043T	0,120	1/2 x 13	16	22	1/2" gas conico	50 mm
TEN02044T	0,120	3/8 x 16	15.5	22	1/2" gas conico	50 mm



	OEM	KG	L (mm)	L1 (mm)	Ø (mm)	b (mm)	c (mm)	a (mm)
TEN02040		0,140	65	15	18	16 x 1,5 mm		
TEN02041		0,045	31	12	16	3/8" UNC		
TEN02042		0,012	20	8	10	M6		
TEN02043		0,085	50	10	16	15,5 mm		
TEN02044	68241	0,070	50	9	15,5	7/16"		
TEN02044TP		0,055				7/16" UNF	22	1/2" gas conico (bspt)

MOTORES DE ARRANQUE STARTERS MOTORINI AVVIAMENTO DÉMARREUR

REF	OEM	⚡	☀️	🔧
REC3916854	3916854 3904445	12V	10	3.9L 4 cil Et 5.9L 6 cil 6BT Et Peniunsular 6.2L 6.9 Et 7.3L Star Power



REF	OEM	⚡	☀️	🔧
REC3604654RX	3604654RX	12V	10	6BT 5.9L



ALTERNADORES ALTERNATORS ALTERNATORE ALTERNATEUR

REF	⚡	SERPENT.	🔧
REC807653T	12V 65A	6 (50 mm)	EI 165, 250, 300 ES 165, 250, 300 2.8 Et 4.2L



REF	OEM	⚡	SERPENT.	🔧
REC882571	882571 8M0084523	12V 50A	6 (50 mm)	CMD 1.7 MI 120 L/L4 CMD 1.7 MS 120 L/L4





# DETROIT DIESEL

## CODO ESCAPE

## EXHAUST ELBOW

## GOMITO SCARICO

## COUDE D'ECHAPPEMENT

REF	OEM	
HGE1086		DD 6-71TI





## ÁNODOS

## ANODES

## ANODI

## ANODES

REF		Ø	B (mm)	
CME4	3/4"	19	5/8 x 11	86
CME2	1/2"	16	7/16 x 14	51
CM8515842	3/4"	19	5/8 x 11	58
CM8515850	3/4"	19	5/8 x 11	100
CME1E	3/8"	12.7	3/8 x 16	38

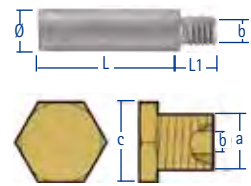

## BOMBA ASPIRACIÓN AGUA MARINA



## RAW MARINE WATER PUMP

## POMPA ASPIRAZIONE ACQUA MARINA



## POMPE À EAU DE MER

REF	OEM		
REC5197221	5197221	REC17937-0001	271



REF	OEM	JABSCO		
REC5145578	5145578	17050	REC17937-0001	353
	5145577	7260		453
	5145576	17030		471





REF	OEM	JABSCO		
REC8923363	8923363	18760	REC17937-0001	8V92TA
	23507475			16V92TA
	23507476			
	23507477			
	23507973			



REF	OEM	JABSCO		
REC8927296	8927296	18780	REC18786-0001	12V71TI
	18780	18789		12V92TA
				16V149TA



REF	OEM	JABSCO		
REC23535447	23535477	17540-0001	REC18786-0001	60
	23525200	17540-0201		



**IMPULSORES      IMPELLER      GIRANTE      TURBINE**

OEM	PALAS BLADES PALE PALES	JOHNSON	JABSCO	SHERWOOD	CEF	RECMAR	A (mm)	B (mm)	C (mm)
	10			SHE18000K	CEF500114T	REC17937-0001	14,29	65	50,1
8927570	12		JAB17370-0001		CEF500152	REC17370-0001	20,2	95	88,5
23502086	9		JAB18786-0001		CEF500153	REC18786-0001	20,2	117,6	88,5
5196168	12	JOH09-814B			CEF500145T	REC875697	22,5	95	88,5
8924838	12	JOH09-819B			CEF500135		22,5	95	63,1
5193553	9	JOH09-1029B			CEF500105T	REC836-0001	22,5	96	93,1
5193602									
5196629	8	JOH09-1028B			CEF500106GT	REC3841697	14,29	65	50,2
5199148									

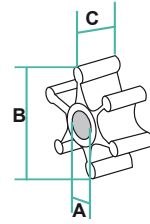

REC17370-0001

REC18786-0001

REC875697

REC836-0001

REC17937-0001

REC3841697

**FISHER PANDA**

**BOMBA AGUA      WATER PUMP      POMPA ACQUA      POMPE D'EAU**

REF	OEM				GENER.	BOMBA PUMP POMPA POMPE
REC10-35127-3	10-35127-3 FP1-000410 IC36.03.01.007H 060-068-0-0-B	3/4"	3/4"	REC653-0001	MINI TYPE PMS6/8/12 (Kubota)	F4B-9



new

REF	OEM				EJE SHAFT ASSE ARBRE	GENER.	BOMBA PUMP POMPA POMPE
REC10-24571-01	10-24571-01 20291	3/4"	3/4"	REC21213660	17 mm	PMS152025KUB IS12, 14, 16, 19	F5B-8



new

**GENERADORES      FENERATORS      GENERATORI      GENERATEUR**

			KIT	FILTRO ACEITE OIL FILTER FILTRO OLIO FILTRE HUILE				KIT	FILTRO ACEITE OIL FILTER FILTRO OLIO FILTRE HUILE
AGTPM 4	REC10077K	REC3586496			PMS 15	REC3586496	REC21213660		
PMS 4	REC3586496	REC3586496			PMS 16 DP		REC21213660		REC1855835
PMS 8 Mini	REC3586496				PMS 20		REC21213660		
PMS 8 DP	REC3586496				PMS 22		REC21213660		REC1855835
PMS 4200	REC3586496				PMS 25		REC21213660		
PMS 6500	REC3586496				PMS 30		REC21213660		
PMS 12 DP	REC3586496				PMS 40		REC21213660		
PMS 12 Mini	REC3586496				PMS 50		REC21213660		

# HURT

## KIT REPARACIÓN TRASMISION

## TRANSMISSION REPAIR KIT

## KIT RIPARAZIONE TRASMISSIONE

## KIT RÉPARATION TRANSMISSION

REF	
A/P2281	20, 220 Et 250



## FILTRO TRASMISIÓN

## TRANSMISSION FILTER

## FILTRO TRASMISSIONE

## FILTRE TRANSMISSION

REF	
REC016940	35-815419 8791014241 879194241 35-813405A1 35-813405 F19608751 FFF001138

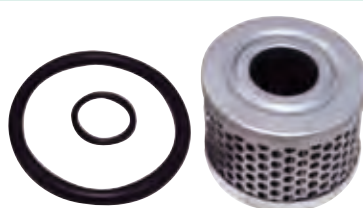

# INDMAR

## COLECTOR ESCAPE

## EXHAUST MANIFOLD

## COLLETTORI SCARICO

## COLLECTEURS D'ÉCHAPPEMENT

REF	OEM		KIT
HOT20997	0994-000	V8 5.0 & 5.7L Bloque pequeño Small block Blocco piccolo Bloque petit 305 & 350	OSC994-MK



REF	OEM		KIT
HOT20998	53-2800	302-351	HOT20998-MK



## CODO ESCAPE

## EXHAUST ELBOW

## GOMITO SCARICO

## COUDE D'ÉCHAPPEMENT

REF	OEM	
HOT20907	53-2009 53-2018	30° 3" DD 6-V8 5.0 & 5.7L Bloque pequeño   Small block Blocco piccolo   Bloque petit 305 & 350



REF	OEM			
HGE2027	53-2027-T	30°	3.5"	DD 6-V8 5.0 Et 5.7L Bloque pequeño   Small block
HOT20939		10°	4"	Blocco piccolo   Bloque petit 305 Et 350

**KITS MONTAJE**      **MONTING KIT**      **KIT MONTI**      **KIT DE MONTAGE**

REF	OEM		
HOT20998-MK			
OSC994-MK			
HOT20992-MK			

**TUBO COMBUSTIBLE**      **FUEL TUBE**      **TUBO CARBURANTE**      **DURITE CARBURANT**  
**BOMBA --> CARBURADOR**      **PUMP --> CARBURETOR**      **POMPA --> CARBURATORE**      **POMPE --> CARBURATEUR**

REF		
REC18-8114	3/8" X 31" PTFE - 5/8"	
REC18-8115	3/8" X 25" PTFE - 5/8"	

**BOMBA ASPIRACIÓN**      **RAW MARINE WATER**      **POMPA ASPIRAZIONE**      **POMPE À EAU DE MER**  
**AGUA MARINA**      **PUMP**      **ACQUA MARINA**

REF	OEM	KIT
REC3860703	685011	REC21213660

**IMPULSOR**      **IMPELLER**      **GIRANTE**      **TURBINE**

REF
JOH09-802B

**ENCENDIDO**      **IGNITON**      **ACCENSIONE**      **ALLUMAGE**

**PLATINO**      **POINT**      **PUNTINE**      **VIS PLATINÉES**

REF	OEM
REC8M6001219	751007



**CONDENSADORES    CONDENSERS    CONDENSATORE    CONDENSEURS**

REF	OEM
REC33662	755017



**ROTORES    ROTORS    ROTORI    DOIGT D'ALLUMEUR**

REF
REC834975



**BOBINAS DE ENCENDIDO    IGNITION COIL    BOBINE ACCENSIONE    BOBINE D'ALLUMAGE**

REF	Resistencia externa. Utilizar con encendido convencional. External resistor. Use with conventional ignition Resistenza esterna. Utilizzare con accensione convenzionale Résistance externe. A utiliser avec un allumage conventionnel.
REC1463-9382	

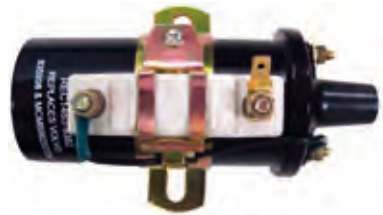

**ALTERNADORES    ALTERNATORS    ALTERNATORE    ALTERNATEUR**

REF	OEM	⚡	🌀 SERPENT.
REC575011	575011	12V 70A	✓



REF	OEM	⚡
REC575010	575010	12V 70A



**MOTORES DE ARRANQUE    STARTERS    MOTORINI AVVIAMENTO    DÉMARREUR**

REF	OEM	⚡	☀️	🔧
REC50-97499A2	573001	12V 1.4 kW	9	GM Et Ford



REF	OEM	⚡	☀️
REC50-808011A05		12V 1.4kw	9

Contrarrotación o montaje en campana  
CCW Starter  
Controrrotante o montato nella campana  
Contre-rotation ou montage sur capot



**JUEGOS DE CABLES, ALTO RENDIMIENTO**

Núcleo del cable de Kevlar de 8 mm antimagnético. Funda de silicona amarilla. Terminales bujías con muelle de acero inox. Terminal del distribuidor de cobre. Terminales bobina. Silicona resistente a altas temperaturas. Garantía de 5 años.

**HD SPARK PLUG WIRE SET**

Antimagnetic Kevlar core. Yellow silicone boot Et jacket. SS snaplock. Brass distributor terminal. Coil terminals. High resistant silicone. 5 year warranty.

**KIT CAVI CANDELE, ALTE PRESTAZIONI**

Nucleo del cavo di Kevlar da 8 mm antimagnetico. Copertura di silicone gialla. Terminali candele con molle di acciaio inox. Terminale lato spinterogeno in rame. Terminale Bobine. Silicone resistente alle alte temperature. Garanzia di 5 anni.

**KIT FAISCEAU DE BOUGIE**

Noyau en Kevlar antimagnétique. Gaine en silicone jaune. Bornes de bougie d'allumage avec ressort en acier inoxydable. Terminal de distribution en laiton. Bornes de bobine. Silicone haute résistance. Garantie de 5 ans.

1	Camisa de silicona de 8 mm	8 mm silicone jacket	Rivestimento in silicone da 8 mm	Gaine silicone de 8mm
2	Látex resistente altas temperaturas	Heat resistant latex	Latex resistente alle alte temperature	Latex résistant à haute température
3	Acero inox	Stainless Steel	Acciaio inox	Acier inox
4	Núcleo de Kevlar	Kevlar core	Nucleo de Kevlar	Noyau de Kevlar
5	Capuchón de silicona	Silicone jacket	Rivestimento in silicone	Capuchon en silicone
6	Trenzado especial fibra de vidrio	Fiberglass braiding	Fibra di vetro	Tresse en fibre de verre
7	Terminal de acero inox	Stainless Steel terminal	Terminale di acciaio inox	Terminal en acier inox

REF	CYL	ARRANQUE IGNITION AVVIAMENTO DEMARRAGE		REF
		CONVEN.	ELECT.	
181 3.0L	4	✓		REC15-401
181 3.0L	4		✓	REC15-405
250 (In-line 6)	6	✓		REC15-602
262 4.3L	6	✓		REC15-604
262 4.3L	6		✓	REC15-601
302, 351 5.0L-5.8L (Ford)	8	✓		REC15-801
350 5.7L	8	✓		REC15-801
350 5.7L	8		✓	MAG15-803
454 7.4L, 502 6.2L	8	✓		REC15-801
454 7.4L, 502 6.2L	8		✓	MAG15-803
454, 502 (Straight plug boot)	8		✓	MAG15-809
V8 Mallory Side Term. Cap	8	✓		REC15-806

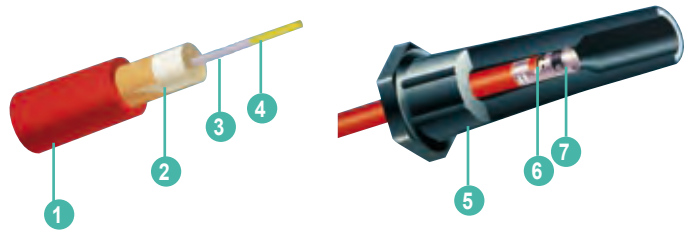

**KOHLER**

**FILTRO**

**FILTER**

**FILTRO**

**FILTRE**

**FILTRO ACEITE**

**OIL FILTER**

**FILTRO OLIO**

**FILTRE D'HUILE**



REF	OEM	Image
REC502900	279449	12.5CF, 15C, 16CF, 20C.





REF	OEM	Image
REC834337	359771	4EF, 5E, 6EF, 7.3E.





REF	OEM	Image
REC229678	229678	4CCFOZ, 4EFOZ, 5CCOZ, 5EOZ, 6.5EFOZ, 8EOZ.





FILTRO COMBUSTIBLE	FUEL FILTER	FILTRO BENZINA	FILTRE D'ESSENCE
REF	OEM		
REC252898	252898	11, 11.5, 13, 13.5, 14, 15, 15.5, 16, 17.5, 18.5, 19, 20, 23, 24 (CCFOZ, EFOZ, EOZD)	
			

TERMOSTATO	THERMOSTAT	TERMOSTATO	THERMOSTAT
REF	OEM		
REC23-3666		Variación 1: 33EFOZ, 33CFOZ, 40CFOZ, 40EOZ, 40EFOZ, 50COZ, 50CFOZ, 50EOZ, 55EFOZ, 65 COZ, 65EOZ, 70EFOZ, 80EOZ, 80EFOZ, 99EOZ, 100EFOZ, 125EOZ, 125EFOZ, 150EOZ	
			

BOMBA AGUA	WATER PUMP	POMPA ACQUA	POMPE D'EAU
REF	OEM		
REC29350-1001	GM58527	CEF500100GX	6EOD 4.5EFOD
			

REF	OEM				
SHEG8001	132-0275	3/8"	3/8"	REC08000K	5-7 KW Diesel Generator
					

REF	OEM				
REC344085 SHEG907P	344085 344371	3/8"	3/8"	REC09000K	Ford 4T o 6.5 kw
					

REF	OEM				
RECGM46936 SHEG910P	GM46936	3/8" NPT	3/8" NPT	REC09000K	Ford
					

**IMPULSORES      IMPELLER      GIRANTE      TURBINE**

OEM	PALAS BLADES PALE PALES	SHERWOOD	CEF	RECMAR	A (mm)	B (mm)	C (mm)
229826	12	SHE09000K	CEF500165	REC09000K	15,9	62,2	22,4
229955	6		CEF500129	REC22779-0001	12,75	50,8	22,1
250872	6						
359978	6	SHE08000K	CEF500190G	REC08000K	12,2	19	40
	12	SHE10077K	CEF500166	REC10077K	12,7	57	19,8
	12	SHE09959K	CEF500103T	REC3854286	16	62	31,5
	12	SHE10615K		REC10615K	15,9	65	41,2
252882				REC21213660			

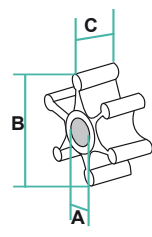

REC21213660



REC09000K      REC22779-0001      REC08000K      REC10077K      REC3854286      REC10615K

**ÁNODOS      ANODES      ANODI      ANODES**

REF	OEM
CME0	260085 267928



**GENERADORES      GENERATORS      GENERATORI      GENERATEUR**

		FILTRO COMB. FUEL FILTER FILTRO COMB. FILTRE ESSENCE		KIT TERMOSTATO THERMOSTAT KIT KIT TERMOSTATO KIT THERMOSTAT	FILTRO ACEITE OIL FILTER FILTRO OLIO FILTRE HUILE	ÁNODO ANODE ANODO ANODE
5 CCOZ	6.5 EFOZ		REC09000K (296899+)		REC36918	CME0
5EOZ			REC22779-0001 (-296898)			
8EOZ			REC09000K (296899+)		REC36918	
8EFOZ			REC22779-0001 (-296898)			
			REC09000K (296899+)		REC36918	CME0
			REC22779-0001 (-296898)			
8CCFOZ	9CCOZ	10EOZ	REC09000K (296899+)		REC229678	
	9EOZ		REC22779-0001 (-296898)			
	9EFOZ					
11 CCFOZ			REC252898 (Var 2)	REC22779-0001	REC229678	
11.5 CCFOZ	13EOZ		REC252898 (Var 2)	REC22779-0001		
11EFOZ	13EFOZ					
11.5EFOZ	13.5 CCOZ					
14 CCOZ			REC252898 (Var 2)	REC22779-0001		
14 EOZ						
15 CCFOZ			REC252898 (Var 3)	REC22779-0001		
15.5EOZ			REC252898 (Var 2)	REC22779-0001		
16EFOZ	18.5 CCOZ	20 CCFOZ	REC252898	REC22779-0001		
17.5EFOZ	19EFOZ	20EOZ	(Var 3)			
20EFOZ	23EOZ	24 CCOZ	REC252898	REC22779-0001		
	24EOZ		(Var 3)			
6.5EFOZD	8EOZD	9 EOZD		REC09000K		
7 EFOZD	8.5 EFOZD	9EFOZD		REC09000K		
10EOZD				REC09000K		
11EFOZD	13EOZD	14 EOZD		REC22779-0001		
11.5EFOZD	13EFOZD	15.5 EOZD				
17 EFOZD	19EFOZD	20EOZD	REC252898	REC22779-0001		
17.5EFOZD		20EFOZD	(Var 3), (Var 1)			
23EFOZ				REC09000K		
				REC22779-0001		
23EOZD			REC252898 (Var 3), (Var 1)	REC22779-0001		
23EFOZD				REC09000K		
				REC22779-0001		
24EOZD			REC252898 (Var 3), (Var 1)	REC22779-0001		
27EFOZ	28EOZ	32EOZ		REC09000K		
27EFOZD	28EOZD	32EOZD		REC3841697		
33EFOZ				REC3841697		
33 CFOZ	40 CFOZ			REC3841697	REC23-3666	
40EOZ				REC3841697		
40EFOZ				REC3841697		
50 COZ				REC3841697	REC23-3666	
50 CFOZ				REC3841697	REC23-3666	
50EOZ	55EFOZ			REC3841697	REC23-3666	
65 COZ				REC3841697	REC23-3666	



		FILTRO COMB. FUEL FILTER FILTRO COMB. FILTRE ESSENCE		KIT TERMOSTATO THERMOSTAT KIT KIT TERMOSTATO KIT THERMOSTAT	FILTRO ACEITE OIL FILTER FILTRO OLIO FILTRE HUILE	ÁNODO ANODE ANODO ANODE
65EOZ			REC3841697			
70EFOZ	80EOZ		REC3841697	REC23-3666		
80EFOZ	99EOZ		REC3841697			
100EFOZ				REC23-3666		
125EOZ						
125EFOZ						
3.5 CFZ			REC22779-0001 (-296898)	23-3610		
4 CZ			REC22779-0001 (-296898)	23-3610		
4EF			REC08000K	23-3608	REC834337	CME0
5 CFZ			REC22779-0001 (-296898)	23-3610		
5ECD			REC08000K			
5E	6EF		REC08000K	23-3608	REC834337	CME0
6EFCD			REC08000K			
6.5 CZ			REC22779-0001 (-296898)	23-3610		
7.3E			REC08000K	23-3608		
7.3ECD			REC08000K			
8E		(GR4 Ver), (Var 2) Inline	REC09000K (296899+) REC22779-0001 (-296898)	23-3608		
9EFGD					REC834337	CME0
10E		(GR4 Ver), (Var 2) Inline	REC09000K (296899+) REC22779-0001 (-296898)	23-3608		
12.5E		(GR4 Ver), (Var 2) Inline	REC09000K (296899+) REC22779-0001 (-296898)	23-3608		
12.5CF			REC09000K (296899+) REC22779-0001 (-296898)	23-3608		
15C			REC09000K	23-3608		
15EG					REC502900	
16CF			REC09000K	23-3608		
17.5CF					REC502900	
20C			REC09000K	23-3608		





## MAN

### BOMBA AGUA

### WATER PUMP

### POMPA ACQUA

### POMPE À D'EAU

REF	OEM					BOMBA PUMP POMPA POMPE	
REC22040-0701S	65.00600.0016	57 mm	57 mm	JOH09-814B	MAN D2676	22040-0701S	<b>new</b>

### IMPULSORES

### IMPELLER

### GIRANTE

### TURBINE

OEM		PALAS BLADES PALE PALES	JOHNSON	CEF	RECMAR	A (mm)	B (mm)	C (mm)
51.06505.0127	D2862LR443	12	JOH09-842B					
51.06505.0103	D2866	12	JOH09-821B	CEF500162G		22,5	65,8	80
50.06506.0089		12	JOH09-814B	CEF500145T	REC875697	22,5	95	88,5
50.06506.0091	D2866	8	JOH09-1028B	CEF500106GT	REC3841697	14,29	65	50,2
51.06505.0106	1050, 1100, 1200, 1300, 1360, 1550 HP	12	JOH09-820B	CEF500186T		22,5	96,5	130

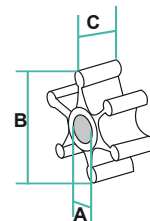

CEF500106GT  
JOH09-821B



REC3841697  
CEF500106GT  
JOH09-1028B



REC875697  
CEF500145T  
JOH09-814B

**BOMBA AGUA WATER PUMP POMPA ACQUA POMPE D'EAU**

REF	OEM			EJE SHAFT ASSE ARBRE	GENER.	BOMBA PUMP POMPA POMPE
REC10-24571-01	10-24571-01 20291	3/4" 3/4"		17 mm	12 KW SERIE	F5B-8



**new**

REF	OEM			EJE SHAFT ASSE ARBRE	GENER.	BOMBA PUMP POMPA POMPE
REC10-24570-01	10-24570-01 20639	3/8 BSP/ NPT		12 mm	ISE.5/7.5	F4B-8



**new**

**GENERADORES GENERATORS GENERATORI GENERATEUR**

IS	MOTOR ENGINE MOTORE MOTEUR	FILTRO   FILTER   FILTRO   FILTRE					ANODO ZN INTERCAM. ZN ANODE EXCHANGE ANODO ZN SCAMB. ANODE ZN ECHANG.		CORREA CINGHIA	BELT COURROIE	BOMBA PUMPA	PUMP POMPE	Solenoid	SENSOR SENSORE PRES. aceite oil olio huile	SENSOR CAPTEUR TEMP. escape exhaust scarico échapp.
		aceite oil olio huile	comb. fuel comb. essence	aire air aria aire	agua-aire water-air acqua-aria eau-air		agua water acqua eau	Alter.							
3.5	2000+ YANMAR L70	MAS97536		MAS013432	JOH09-808B	TEN02070T				MAS70196 (-2008) MAS71008 (2009+)	REC10-24569-01	MAS31004		MAS30253	
5.0	2000+ YANMAR L100	MAS97536		MAS013432	JOH09-808B	TEN02070T				MAS71008 (-2008) MAS71365 (2009+)	REC10-24569-01	MAS31004		MAS30253	
6.1	2006 + KUBOTA Z482	MAS912422	MAS912423	MAS014020	JOH09-810B	TEN02070T	MAS11885	MAS912163				MAS31004	MAS912168	MAS30253	
6.5 TNE	2000-06 YANMAR 3TN74 A-MG	REC119305-35151	REC129470-55703	MAS014020	JOH09-810B	TEN02070T	MAS011943	MAS910207	MAS71183	REC10-24570-01	MAS31004		MAS92682	MAS30253	
7 TNV	2006 + YANMAR 3TNV76-GMG	REC119305-35151	MAS911450	MAS014020	JOH09-810B	TEN02070T	MAS11885	MAS912357	MAS71365	REC10-24570-01	MAS31004		MAS92682	MAS30253	
8 TNE	2000-06 YANMAR 3TNE78 A-MG	REC129150-35153	REC129470-55703	MAS014020	JOH09-810B	TEN02070T	MAS011943	MAS910208	MAS71166	REC10-24570-01	MAS31004		MAS92682	MAS30253	
9 TNE	2000-06	REC129150-35153	REC129470-55703		JOH09-810B	TEN02070T	MAS011943	MAS910141	MAS71166	REC10-24570-01	MAS31004		MAS92682	MAS30253	
9 TNV	2006-21 3TNV82 A GMG	REC129150-35153	REC119802-55810	MAS014020	JOH09-810B	TEN02070T	MAS11885	MAS910141	MAS71166	REC10-24570-01	MAS31004		MAS92682	MAS30253	
9.1 KUB	2006 + KUBOTA D722 17HP	MAS912422	MAS912423	MAS025222	JOH09-810B	TEN02070T	MAS011943	MAS912163				MAS31004	MAS912168	MAS30253	
11.2 TNV	2006-13 3TNV70 HGE	REC119305-35151	MAS911450	MAS014020	JOH09-810B	TEN02070T	MAS011943		MAS71270	REC10-24570-01	MAS31004		MAS92682	MAS30253	
12 TNE	2000-06 YANMAR 3TNE88	REC129150-35153	MAS92892	MAS014020	JOH09-1027B	MAS80159 (-2003) MAS911730 (2004+)	TEN02053T	MAS910141	MAS71204	REC10-24571-01			MAS92682	MAS30253	
12 TNV	2006 + YANMAR 3TNV88 GGE	REC129150-35153	REC119802-55810	MAS014020	JOH09-1027B	MAS911730	TEN02053T	REC129612-42290E	MAS71204	REC10-24571-01	MAS31004		MAS92682	MAS30253	
13.1 TNVT	2006-18	REC129150-35153	REC119802-55810			MAS911730									
16 TNE	2006 + YANMAR 4TNE88 G1A	REC129150-35153	MAS92892	MAS014020	JOH09-1027B	MAS80159	TEN02053T	MAS910141	MAS71204	REC10-24571-01			MAS92682	MAS30253	
16 TNV	2006 + YANMAR 4TNV88 GGE	REC129150-35153	REC119802-55810	MAS014020	JOH09-1027B	MAS911730	TEN02053T	REC129612-42290E	MAS71204	REC10-24571-01	MAS31004		MAS92682	MAS30253	
20.1 TNVT	2006-18 YANMAR 4TNV84T GMG	REC129150-35153	REC119802-55810			MAS911730									
22K	2017 + KUBOTA V2403 BG	MAS913347	MAS913348	MAS014020	JOH09-812B	MAS911730	TEN01320T	MAS913354							
25 TNV	2006 + YANMAR 4TNV98 GGE	REC129150-35153	REC119802-55810	MAS027318	JOH09-1027B	MAS911730	MAS018807	MAS912277	MAS71110	REC10-24571-01	MAS31004		MAS92682	MAS30253	
25 TNE	2000-06 YANMAR 4TNE 94	REC129150-35153	MAS92958	MAS027318	JOH09-1027B			MAS910604	MAS71110						
MARINER															
45	PERKINS 1103A-33TG1				JOH09-1027B		MAS11885			REC10-24571-01					

**IMPULSORES      IMPELLERS      GIRANTI      TURBINES**

OEM		PALAS BLADES PALE PALES	JOHNSON	JABSCO	CEF	RECMAR	A (mm)	B (mm)	C (mm)
434014		6	JOH09-810B		CEF500101X	REC653-0001	12,17	50,8	22,1
434013	FK2,40E/HE 2,60H KLA L30 3,90 FK3 2,45H2 2,5HE 2,60HE 3,75HE 3,90H/HE 4,110.H 3,100HE 3,110HE 4,110HE 4,150HE 4,180 4,190HE 4,200HE MB180 220 230 4,220HE 4,330TDI 4,440E 5,280HE 5,250TDI 5,300/T 6,280HE 6,570T 6,660E/LE 4,230 4,240 4,380 5,300	6	JOH09-808B		CEF500121GX	REC3586496	12	39,6	19,2
		10			CEF500146X		12,17	51,8	22
		12	JOH09-1027B			REC21213660	14,29	57	31,6
		10		JAB17937-0001-P	CEF500114T	REC17937-0001	14,29	65	50,1
50.06506.0091	1300,16	8	JOH09-1028B		CEF500106GT	REC3841697	14,29	65	50,2
50.06506.0089	1300,16	12	JOH09-814B		CEF500135	REC21730344	22,5	95	63,1
51.06506.0103			JOH09-821B						
51.06506.0106			JOH09-820B						

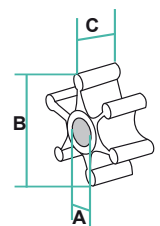

REC17937-0001



REC21730344



REC653-0001



REC21213660





REC3841697



REC3586496

**ALTERNADORES      ALTERNATORS      ALTERANATORE      ALTERNATEUR**

REF	OEM			
REC873770	48200932	12V 60A	RM841812	NK2.4ECO NK2.50HE NK3.100HE NK3.75HE NK4.150HE NK4.200HE NK4.220HE NK5.250TDI NK5.2800HE



Se suministra sin polea  
It is supplied without pulley  
Viene fornito senza puleggia  
Ne comprend pas la poulie

**FILTRO FILTER FILTRO FILTRE**

**FILTRO COMBUSTIBLE FUEL FILTER FILTRO BENZINA FILTRE D'ESSENCE**

REF	OEM	
REC149-0428	149-0428	MDJA, MDJB, MDJC (Spec A-R) MDJE, MDJC (Spec. A)

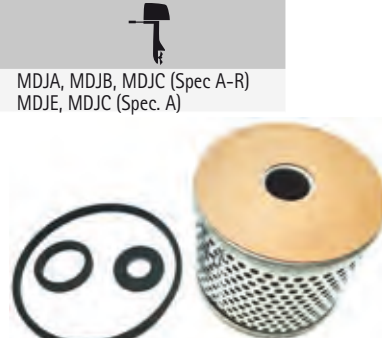

REF	OEM	
REC1492250I	1492250	40DGCA-50DGCA 30MDGBA-35MDGCA 45MDGCA

BY-PASS I  
Filtro | Filter | Filtro | Filtre I



REF	OEM	
REC149-2106	149-2106 A026K278	8,0DKD 10DKG



REF	OEM	
REC1492251II	1492251 II	40DGCA-50DGCA 30MDGBA-35MDGCA 45MDGCA

BY-PASS II  
Filtro | Filter | Filtro | Filtre II



REF	OEM	
REC1491758	1491758	20KW-MDL4W2423D MDLGWLG34D-L423D-L423 L423P-LG34W-25MDLG 45MDLG-30MDLG-L317DW 16MDL224-20MDL4-12MDL3



REF	OEM	
REC1491754	1491754	50DDB-W9D

Cristal | Crystal | vetro | Verre



**FILTRO ACEITE OIL FILTER FILTRO OLIO FILTRE D'HUILE**

REF	OEM	
REC1220602	1220602	L317DW 16MD224 20MDL4 12MDL3

Filtro corto | Small filter  
Filtro corto | Filtre court



REF	OEM	
REC1855835	1855835 185-5835	8,5KV-10KV MDKAA MDKAB MDKAV MDKBG MDKAW MDKAZ MDKAL MDKBL MDKBL MDKBM MDKBN





REF	OEM	
REC185-2133	185-2133	8.0DKD-10DKG

REF	OEM	
REC1220716712	122.0716.712	40DGCA-50DGCA 30MDGBA-35MDGCA 45MDGCA

REF	
REC35-06003	50DDB-W9D

REF	OEM	
REC1220550	122-0550	20KW-MDL4W2423D-MDLGWLG34D L423D-L423-L423P-LG34W-25MDLG 45MDLG-30MDLG-L317DW-16MDL224 20MDL4-12MDL3

REF	OEM	
REC1220810	1220810 122-0810	17,5 MDKAE MDKDB MDKBF MDKAD MDKAE MDKAF

REF	OEM	
REC1870014	187.0014	45MDGGA 55MDGGA

**BOMBA ASPIRACIÓN  
AGUA MARINA**

**RAW MARINE WATER  
PUMP**

**POMPA ASPIRAZIONE  
ACQUA MARINA**

**POMPE À EAU DE MER**

REF	OEM		
SHEG702	132-0358 132-0459	REC10077K	6.5 - 10kW



**BOMBA AGUA**

**WATER PUMP**

**POMPA ACQUA**

**POMPE À EAU**

REF	OEM		
SHEK75B	132-0275 135-0278	1" 1" REC3854286	4 CYL



REF	OEM		
SHEL10B	1320278 132-0278	1 1/4" 1 1/4" REC10615K	5 CYL MDL6 (30kW)



REF	OEM				
SHEG1010	132-0343 132-0347 132-0356 132-0413	1"	1"	REC10615K	10-25 KW Reemplaza   <a href="#">Replace</a>   <a href="#">Sostituiscie</a>   <a href="#">Remplace</a> : G1004, G1005, G1008



REF	OEM		
SHEG8002	132-0395 132-0430	REC08000K	Reemplaza   <a href="#">Replace</a>   <a href="#">Sostituiscie</a>   <a href="#">Remplace</a> : G1009



REF	OEM				
SHEG1012	132-0464	1 1/4"	1 1/4"	REC10615K	Reemplaza   <a href="#">Replace</a>   <a href="#">Sostituiscie</a>   <a href="#">Remplace</a> : G1009



REF	OEM					BOMBA PUMP POMPA POMPE	GENER.	
RECG8002	G8002 132-0430 132-0415 132-0395	3/8"	3/8"	REC08000K	QD5/5/6/7.5/8 KW	G8002	Cummins Onan MDK BH/J/W	129 mm



REF	OEM					BOMBA PUMP POMPA POMPE	GENER.
RECG702	G702 G701 132-0459 132-0379 132-0358	1"	1"	REC10077K	QD6.5/7/9/9.6/11.5/11/13.5 KW	G702	Cummins Onan MDK BK/L/M/N MDKDK/M/N



REF	OEM					BOMBA PUMP POMPA POMPE	GENER.
RECG1010	G1010 G1010-1 132-0413 132-0356 132-0347 132-0343 A029U129	1"	1"	REC10615K	QD 13.5/17/17.5/19/21.5 KW	G702	Cummins Onan MDK DP/R/V MDK BP/R



REF	OEM					BOMBA PUMP POMPA POMPE	GENER.
RECG1012	G1012 G1009 132-0464 A032Y747	1 1/4"	1 1/4"	REC10615K	QD 22.5/27/29 KW	G702	Cummins Onan MDK DS/T/U MDK BT/BU



**KITS REPARACIÓN      REPAIR KITS      KIT RIPARAZIONE      KIT RÉPARATION**

	NUM.		KIT MENOR KIT MINOR KIT MINEUR	KIT MAYOR KIT MAJOR KIT MAGGIORE KIT MAJEUR
12MDJC-15 MDJF	132C115	SHE09959K		
4CYL DIESEL	132-0275	SHE09959K	SHE23979	SHE12665
5CYL DIESEL	132-0278	SHE10615K	SHE23976	SHE23977
5CYL DIESEL	132-0271	SHE09000K		
5CYL DIESEL	132-0343	SHE10615K		
5CYL DIESEL	132-0347	SHE10615K		
10-25Kw	132-0356	SHE10615K		
6.5-10Kw	132-0358	SHE10077K		
4.8Kw		SHE08000K		



**IMPULSORES      IMPELLER      GIRANTE      TURBINE**

OEM	PALAS BLADES PALE PALES	JABSCO	JOHNSON	SHERWOOD	CEF	RECMAR	A (mm)	B (mm)	C (mm)
08-21-1201									
132-0162	12	JAB12104-0001	JOH09-1027B		CEF500107T	REC21213660	14,29	57	31,6
131-0050									
132-0117	12			SHE09959K	CEF500103T	REC3854286	15,9	62	31,7
132-0317				SHE10615K	CEF500120T	REC10615K	15,9	65,2	41,3
132-0349	12			SHE10615K	CEF500120T	REC10615K	15,9	65,2	41,3
132-0348	12			SHE10615K	CEF500120T	REC10615K	15,9	65,2	41,3
132-0292									
132-0375	12			SHE10077K	CEF500166	REC10077K	12,8	56,6	19,8
132-0498	12			SHE10077K	CEF500166	REC10077K	12,8	56,6	19,8
132-0859	6		JOH09-806B		CEF500100GX	REC3586494	9,54	39,6	18,94
132B59									
132-0415	6			SHE08000K	CEF500190G	REC08000K	12,2	19	40
132-0407	6			SHE08000K	CEF500190G	REC08000K	12,2	19	40

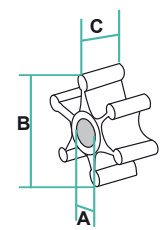



**ÁNODOS      ANODES      ANODI      ANODES**



TEN	OEM		Ø	
TEN02030			8	10
TEN02031	TEN02031TP		9,5	13
TEN02032			M8	10
TEN02033			3/8 UNC	12
TEN01318T	130-4434			



**MOTOR ARRANQUE**
**STARTER**
**MOTORINO AVVIAMENTO**
**DÉMARREUR**

REF	OEM			GENER.	
REC879194371	879194371	3 CYL CW	12V 1.2 KW	9	8KW
	882481				
	889903				
	185-2166				

**new**
**GENERADORES**
**GENERATORS**
**GENERATORI**
**GENERATEUR**

	FILTRO COMB. FUEL FILTER FILTRO COMB. FILTRE ESSENCE	 KIT	FILTRO ACEITE OIL FILTER FILTRO OLIO FILTRE HUILE	ÁNODO ANODE ANODO ANODE
MDKAU	REC149-2106			
MDKAV				
MDKBG				
MDKAW (Spacesaver)	REC149-2106	REC10615K	REC1855835	TEN01318T
MDKAZ				
MDKBD				
MDKBE				
MDKBF				
MDKBD (w/ Isolated Ground)	REC149-2106	REC10615K	REC1220810	TEN01318T
MDKBE (w/ Isolated Ground)				
MDKBF (w/ Isolated Ground)				
MDKBH				
MDKBK				
MDKBL				
MDKBM				
MDKBN				
MDKBP				TEN01318T
MDKBR				
MDKBS				
MDKBV				
MDKBT				
MDKBU				
MDDCA				
MDDCB				
MDDCC				
MDDCF				
MDDCG				CME2
MDDCD				
MDDCE				
MDDCH				
MDDCJ				
MDJA				
MDJB	REC149-0428 (Spec A-R)			
MDJC				
MDJE	REC149-0428 (Spec A)			
MDJF				
MDKAD/E/F	REC149-2106		REC1220810	
MDKAL/A/B		REC10077K	REC1855835	







CODO ESCAPE

EXHAUST ELBOW



GOMITO SCARICO



COUDE D'ECHAPPEMENT

REF	OEM	
SED3092201	T6.354.4AM 220 HP	

REF	OEM		
MAR345	3776F024 Perkins Prima Marine 50		REC888596



REF	OEM	
SED3092200	T6.354.4AM 220 HP	

REF	OEM		
MAR906 RM861906	M20 135616660 M30 M35		REC861907





COLECTOR ESCAPE

EXHAUST MANIFOLD

COLLETTORI SCARICO

COLLECTEURS D'ECHAPPEMENT

REF	OEM	
BAPE-1-6354	89058	T6.354M - 160 HP



FILTRO

FILTER

FILTRO

FILTRE

FILTRO ACEITE

OIL FILTER

FILTRO OLIO

FILTRE D'HUILE

REF	OEM			
REC35-816168	2654407 2654347	4.154M	4.248	HT6.354
		4.192	4.300	HT6.354M
		4A.203	A4.300	6.3544
		P4.192	6.247	T6.3544
		P4.192Y	6.354	ST6.3544
		P4.203	6.354M	6.372
		4.203	H6.354	V8-510
		4.236	H6354M	AV-8-540
		4.236M	6.354	V8-605
		4A236	T6.354M	AV8-640
				TV8-640



FILTRO COMBUSTIBLE

FUEL FILTER

FILTRO BENZINA

FILTRE ESSENCE

REF	OEM	
REC3581078	4.154M	4.248
	4.192	4.300
	4A.203	A4.300
	P4.192	6.247
	P4.192Y	6.354
	P4.203	6.354M
	4.203	H6.354
	4.236	H6354M
	4.236M	6.354
	4A236	T6.354M



FILTRO DECANTADOR DIESEL

COMPLETE DIESEL FILTER

FILTRO DECANTATORE DIESEL

FILTRE DECANTEUR DIESEL

REF		
REC1140639	REC3581078	50 l/h





REF		
REC120	RACR12	15 l/h



**new**



REF			
REC296TWIN	REC3581078	50 L/H	GS30432 (8mm) GS30433 (10 mm)

**new**



REF				CUBETA BOWL VASCHETTA SEAU METAL.
REC2656613	REC3581078	50 l/h	GS30432 (8mm) GS30433 (10 mm)	

BOMBA ASPIRACIÓN AGUA MARINA

RAW MARINE WATER PUMP

POMPA ASPIRAZIONE ACQUA MARINA

POMPE À EAU DE MER

REF	OEM		
REC29350-1001	M20	CEF500100GX	M20



**BOMBA AGUA WATER PUMP POMPA ACQUA POMPE D'EAU**

REF	OEM			
SHEH5	NA005576	1"	1"	4-154 6-345D



REF	OEM		
SHEG65		3/4" NPT	3/4" NPT



REF	OEM			
RECO9140	NA001175	1 1/4" NPT	1 1/4" NPT	4.107-4.154



**ÁNODOS ANODES ANODI ANODES**

ANODO	KIT			Ø	
TEN02040				16 x 1,5	18 65
TEN02041				3/8 UNC	16 31
TEN02042				M6	10 20
	TEN02043T	1/2 BSPT		15,5 mm	16 50
	TEN02044T	1/2 BSPT		7/16" UNF	16 50
	TEN02000T	1/2 BSPT		7/16" UNF	16 54







**IMPULSORES IMPELLER GIRANTE TURBINE**

OEM	PALAS BLADES PALE PALES	JOHNSON	JABSCO	SHERWOOD	CEF	RECMAR	A (mm)	B (mm)	C (mm)
24880272	6	JOH09-806B			CEF500100GX	REC3586494	9,54	39,6	18,94
24880194	6	JOH09-1026B			CEF500116GX	REC3593659	12,66	50,8	22,1
460027	9	JOH09-1029B			CEF500105T	REC836-0001	22,5	96	63,1
24880190	12	JOH09-1027B			CEF500107T	REC21213660	14,29	57	31,6
0460038									
24880031	10		JAB17937-0001-P		CEF500114T	REC17937-0001	14,29	65	50,1
0460024									
460027	12				CEF500145T	REC875697	22,5	95	88,5
NA900010	12			SHE09959K	CEF500103T	REC3854286	15,9	62	31,7
24880178									
NA900012	12			SHE10615K	CEF500120T	REC10615K	15,9	65,2	41,3



KITS REPARACIÓN		REPAIR KITS		KIT RIPARAZIONE		KIT RÉPARATION	
BOMBA PUMP POMPA POMPE		KIT MENOR KIT MINOR KIT MINOR KIT MINEUR	KIT MAYOR KIT MAJOR KIT MAGGIORE KIT MAJEUR				
	SHE10615K		SHE11068	CEF500107T			
SHEG65	SHE09959K		SHE12221				
SHEH5	SHE09959K			SHE09959K			
REC09140	REC21213660	JOH09-1027B	CEF500107T				
				SHE12221			
				SHE11068			
				JOH09-1027B			

MOTOR ARRANQUE		STARTER		MOTORINO AVVIAMENTO		DÉMARREUR	
REF	OEM			REF	OEM		
REC21323043	185086600 12V 1.4 kw	9		REC21302969	185086610 12V 1.4 kw 185086620	9	
							

PLEASURECRAFT

JUNTAS CULATA		CYLINDER HEAD GASKETS		GUARNIZIONE TESTATA		JOINT DE CULASSE	
REF	OEM			REF	OEM		
REC17030	6269577 GM 305, 350 CID			FEL17060	RM0032 Ford 302, 351 CID		
							

ESCAPE		EXHAUST		SCARICO		ECHAPPEMENT	
PROTECTOR SALIDA ESCAPE	EXHAUST PROTECTOR VALVE	PROTEZIONE SCARICO	PROTECTEUR ÉCHAPPEMENT				
REF				REC34765A2			
REC34765A2	3"			REC12644A1			
REC12644A1	4"			REC89260			
REC89260	5" necesita 2 cortes de 45° 5" requires two 45° cuts 5" richiede due tagli a 45° 5" nécessite 2 coupes à 45° 6"						



**COLECTOR ESCAPE**      **EXHAUST MANIFOLD**      **COLLETTORI SCARICO**      **COLLECTEURS D'ECHAPPEMENT**

REF	OEM		KIT
HOT20996	R028001	V8 (Bloque pequeño   Small block   Blocco piccolo   Bloque petit)	HOT20996-MK



HOT20996-MK



**CODO ESCAPE**      **EXHAUST ELBOW**      **GOMITO SCARICO**      **COUDE D'ECHAPPEMENT**

REF	OEM		KIT
HOT20011	R029001	3 1/2" V8 (Bloque pequeño   Small block   Blocco piccolo   Bloque petit)	HOT20899-MK



HOT20899-MK



**JUNTAS COLECTOR ESCAPE**      **EXHAUST MANIFOLD GASKET**      **GUARNIZIONE COLLETTORE SCARICO**      **JOINT COLECTEUR D'ECHAPPEMENT**

REF	
HOT27214-MK	Ford 305, 350 CID GM V8 (Bloque pequeño   Small block   Blocco piccolo   Bloque petit)



REF	OEM
REC3852455	RM0007



REF	OEM
REC27-33395	CHV-47-000



**TAPÓN DE DRENAJE**      **DRAIN TAP**      **TAPPO DI DRENAGGIO**      **BOUCHON VIDANGE**

REF
REC82745



**BOMBA CIRCULACIÓN DE BLOQUE**      **BLOCK CIRCULATING PUMP**      **POMPA DI RICIRCOLO DI BLOCCO**      **POMPE D'EAU**

REF	OEM	
REC3853796	RA057004	Ford 302, 351W



REF	OEM	
REC46-8M0113735	RA057019	Bidireccional. Bi-directional. Bidirezionale. Bidirectionnel.



REF	OEM	
REC46-8M0113734	RA057018	GM V6 Et V8 (Bloque pequeño   Small block   Blocco piccolo   Bloque petit)



**BOMBA ASPIRACIÓN  
AGUA MARINA**



**RAW MARINE WATER  
PUMP**

**POMPA ASPIRAZIONE  
ACQUA MARINA**



**POMPE À EAU DE MER**

REF	OEM		
RECP1014 SHEP1014	40050	1 1/4"	SHE10615K 220, 270, 300, 350



REF	OEM		
SHEG21	RA57007	1"	SHE09959K 302 Et 351



REF	OEM		
REC3860703	RA057026 RA057023	1 1/4"	CEF500104 5.7L

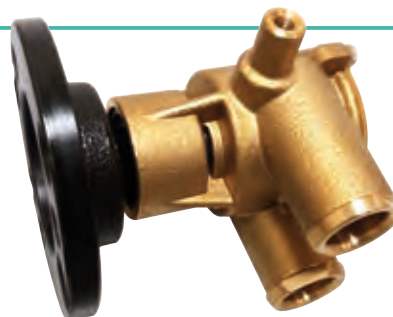

**KITS REPARACIÓN**

**REPAIR KITS**

**KIT RIPARAZIONE**

**KIT RÉPARATION**

REF	OEM	
SHE10615K	RP061017	GM V-Belt
SHE09959K	RP061015	Ford
JOH09-1027B		



JOH09-1027B



SHE10615K





SHE09959K

**KITS TERMOSTATO**

**THERMOSTAT KITS**

**KIT TERMOSTATO**

**KIT TERMOSTAT**

REF	OEM		
REC8M0089715	R026002E	FORD 302/351 CID	140°



REF	OEM	
REC97361	RP026002E	FORD 302/351 CID



**BOMBA COMBUSTIBLE**

**FUEL PUMP**

**POMPA COMBUSTIBILE**

**POMPE CARBURANT**

REF	OEM	
REC62092T	40050	FORD V8, 302



**JUNTA BOMBA**

**PUMP GASKET**

**GUARNIZIONE POMPA**

**JOINT POMPE**

REF	OEM
REC27-34213	3705042



**FILTRO ACEITE**

**OIL FILTER**

**FILTRO OLIO**

**FILTRE D'HUILE**

REF	OEM
REC35-06003	R077002



REF
REC3850559



REF	OEM
REC35-06007	R077001



REF
REC3517857



**CARBURADOR**

**CARBURETOR**

**CARBURATORI**

**CABURATEURS**

**KIT**

**KIT**

**KIT**

**KIT**

REF	OEM	
REC1396-4656	RN0116 RN0116-2	155, 165, 175, 185 302" (5.0L)

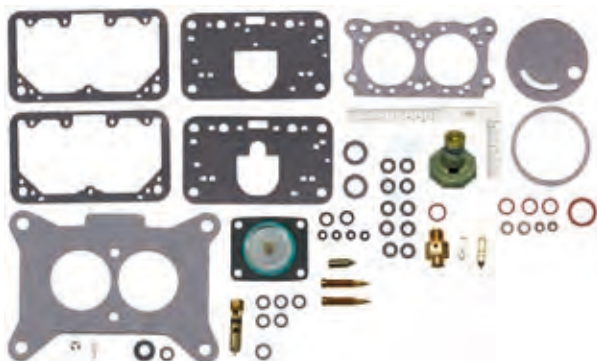

REF	OEM	
REC1396-5238	RN0118 RN0120	215, 255, 215 302" (5.0L) 351" (5.8L)



<b>CHOKE TERMOSTATO</b>	<b>THERMOSTAT CHOKE</b>	<b>CHOKE TERMOSTATO</b>	<b>CHOKE TERMOSTAT</b>				
<table border="1"> <thead> <tr> <th>REF</th> <th>OEM</th> </tr> </thead> <tbody> <tr> <td>REC1396-4148</td> <td>RN0116 RN0116-2</td> </tr> </tbody> </table>	REF	OEM	REC1396-4148	RN0116 RN0116-2	HOLLEY		
REF	OEM						
REC1396-4148	RN0116 RN0116-2						

<b>SENSORES</b>	<b>SENSORS</b>	<b>SENSORI</b>	<b>CAPTEURS</b>				
<b>PRESIÓN ACEITE</b>	<b>OIL PRESSURE</b>	<b>PRESSIONE OLIO</b>	<b>PRESSION D'HUILE</b>				
<table border="1"> <thead> <tr> <th>REF</th> <th>OEM</th> </tr> </thead> <tbody> <tr> <td>REC8M0068784</td> <td>R0200001</td> </tr> </tbody> </table>	REF	OEM	REC8M0068784	R0200001	80 PSI		
REF	OEM						
REC8M0068784	R0200001						

<b>SENSOR DE PICADO</b>	<b>KNOCK SENSOR</b>	<b>SENSORE DI ANTICIPO</b>	<b>CAPTEURS DE CLIQUETIS</b>				
<table border="1"> <thead> <tr> <th>REF</th> <th>OEM</th> </tr> </thead> <tbody> <tr> <td>REC806612T</td> <td>R020027</td> </tr> </tbody> </table>	REF	OEM	REC806612T	R020027			
REF	OEM						
REC806612T	R020027						

<b>SENSOR ÁRBOL DE LEVAS</b>	<b>CAMSHAFT SENSOR</b>	<b>SENSORE ALBERO A CAMME</b>	<b>CAPTEUR ARBRE À CAMES</b>				
<table border="1"> <thead> <tr> <th>REF</th> <th>OEM</th> </tr> </thead> <tbody> <tr> <td>REC892615002</td> <td>R020035A</td> </tr> </tbody> </table>	REF	OEM	REC892615002	R020035A			
REF	OEM						
REC892615002	R020035A						

<b>IAC</b>							
<table border="1"> <thead> <tr> <th>REF</th> <th>OEM</th> </tr> </thead> <tbody> <tr> <td>REC3843751</td> <td>R084003</td> </tr> </tbody> </table>	REF	OEM	REC3843751	R084003			
REF	OEM						
REC3843751	R084003						

<b>ENCENDIDO</b>	<b>IGNITON</b>	<b>ACCENSIONE</b>	<b>ALLUMAGE</b>								
<b>TAPAS DISTRIBUIDOR</b>	<b>DISTRIBUTOR CAPS</b>	<b>CALOTTE SPINTEROGENI</b>	<b>TÊTE D'ALLUMEUR</b>								
<table border="1"> <thead> <tr> <th>REF</th> <th>OEM</th> </tr> </thead> <tbody> <tr> <td>REC392-9766</td> <td>RA108003</td> </tr> </tbody> </table>	REF	OEM	REC392-9766	RA108003		<table border="1"> <thead> <tr> <th>REF</th> <th>OEM</th> </tr> </thead> <tbody> <tr> <td>REC835702</td> <td>RA108002</td> </tr> </tbody> </table>	REF	OEM	REC835702	RA108002	 
REF	OEM										
REC392-9766	RA108003										
REF	OEM										
REC835702	RA108002										



REF	OEM
REC392-9086T	



REF	OEM
REC982209	R08001



REF	OEM
REC898253T22	RA108009

MP 5.0L, 5.7L (2002-05)



REF	OEM
REC393-4988	



**PLATINO**                      **POINT**                      **PUNTINE**                      **VIS PLATINÉES**

REF	OEM
REC8M6001219	R114002



REF	OEM
REC391-5090	R114001 R114004



REF
REC71831



**CONDENSADORES**                      **CONDENSERS**                      **CONDENSATORE**                      **CONDENSEURS**

REF	OEM
REC8M6001217	R115001



REF	OEM
REC8M6001249	



REF	OEM
REC33662	R115002



REF	OEM
REC64851	



**ROTORES**                      **ROTORS**                      **ROTORI**                      **DOIGTS D'ALLUMEUR**

REF	OEM
REC3853801	R103004



REF	OEM
REC89825302	R103001



REF	OEM
REC898253013	R103011

MP 5.0L, 5.7L (2002-05)



REF	OEM
REC834975	R103003



KITS

KIT

KIT

KIT

REF

REC392-6324Q1



REC3853801 + REC8M6001219 + REC8M6001249

REF

REC391-5090Q1



REC89825302 + REC391-5090 + REC8M6001217

DISTRIBUIDOR

DISTRIBUTOR

SPINTEROGENI

ALLUMEUR

REF

REC392-6316

OEM

RA107001

MALLORY YL512CV  
FORD 302 CID V8



REF

REC392-6330

MALLORY YL554CV  
FORD 351 CID V8

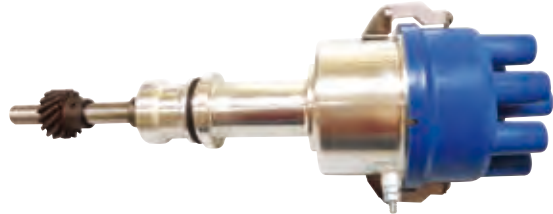

REF

REC17177A1

MALLORY YL624MW  
GM V8



REF

REC805222A1

OEM

RA107039E

V8 264, 454, 502

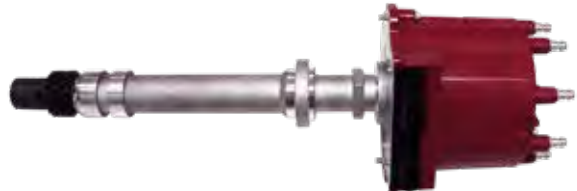

REF

REC807964A1

V6



REF

REC21622232

V8

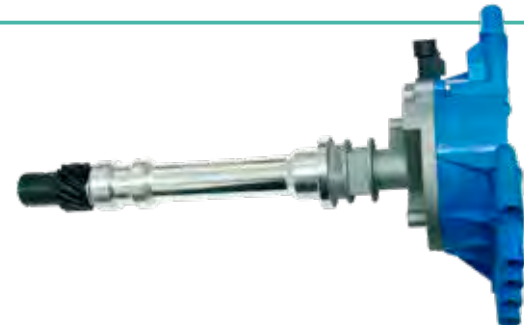

**KITS CONVERSIÓN ELECTRONICO**

**ELECTRONIC CONVERSION KIT**

**KIT CONVERSIONE ELETTRONICO**

**KIT, CONVESION ELECTRONIQUE**

REF



REC26904

Mallory YL o YD con rotación reloj y contrareloj. 8 cyl.  
For most Mallory V8 distributors  
8 cilindri Mallory YL o YD con rotazione oraria e antioraria  
Mallory YL ou YD avec rotation dans le sens des aiguilles d'une montre et dans le sens inverse. 8 cyl.



REF



REC26905

Para la mayoría de distribuidores Prestolite V8 con tornillo en la tapa  
For most Prestolite V8 distributors with screw on cap  
Per al maggior parte degli spinterogeni Prestolite V8 con vite nella calotta.  
Pour la plupart des distributeurs Prestolite V8 avec couvercle à vis



REF



REC18-5295

4 cyl Prestolite.



REF



REC26901

Delco 6 cyl.



**BOBINAS DE ENCENDIDO IGNITION COIL**

**BOBINE ACCENSIONE**

**BOBINE D'ALLUMAGE**

REF

OEM

REC1463-9382

R117001

Resistencia externa. Utilizar con encendido convencional.  
External resistor. Use with conventional ignition  
Resistenza esterna. Utilizzare con accensione convenzionale  
Résistance externe. A utiliser avec un allumage conventionnel.



REF

REC300-00879

No usa resistencia externa. Utilizar con encendido Prestolite.  
Use without external resistor & Prestolite ignition  
Non utilizza resistenza esterna. Utilizzare con spinterogeno Prestolite  
N'utilise pas de résistance externe. A utiliser avec l'allumage Prestolite.



REF

REC3861267

R117012



**JUEGOS DE CABLES, ALTO RENDIMIENTO**

**HD SPARK PLUG WIRE SET**

**KIT CAVI CANDELE, ALTE PRESTAZIONI**

**KIT FAISCEAU DE BOUGIE**



	ARRANQUE IGNITION AVVIAMENTO DEMARRAGE		REF
	CONVEN.	ELECT.	
262 CID (4.3L)	6	✓	REC15-604
V8 (Tapas de terminal   Top terminal caps   Coperchio terminali   Couverclea de terminal)	8	✓	REC15-801
V8 (Mallory lateral de terminal   Side terminal caps   Coperchio laterali   Couvercles latéral de terminal)	8	✓	REC15-806
454 (7.4L)	8	✓	MAG15-809

MOTOR ARRANQUE STARTER MOTORINO AVVIAMENTO DÉMARREUR

REF	OEM	⚡	⚙️	🔧
REC50-97499A2	RA122008 9000888	12V 1.4 kw	9	GM & Ford



REF	OEM	⚡	⚙️	🔧
REC50-808011A05	RA122009	12V 1.4 kw	9	305 5.0L Contrarrotación o montaje en campana CCW Starter Controrotante o montato nella campana Contra-rotation o montage dans une cloche



REF	OEM	🔧
REC3854190	RA122001 987811 RK122014	302 5.0L Con 2 tornillos de anclaje 2 mounting holes Con 2 viti di supporto Avec 2 vis de support



REF	⚡	⚙️	🔧
REC50-99418A2	12V	9	305 5.0L (1976-95)



REF	🔧
RECRA122002	302 5.0L Contrarrotación. Counter clockwise starter Controrotante. Contra-rotation



REF
REC50-863007A1



ALTERNADORES ALTERNATORS ALTERNATORI ALTERNATEUR

REF	OEM	⚡	🔧	⚙️	REG.
REC0985964	12V 63A	231 3.8L (1981-95) 305 5.0L (1976-95)		Simple Single Singola Simple	Autoexcitante Self-exciting Auto-eccitante Auto-excitant



REF	OEM	⚡	⚙️
REC69729	RA097002 RA097003 RA097006	12V 68A	Polea de transmisión Drive pulley Puleggia di azionamento Poulie de transmission







REF	⚡		REG.
REC3860769	12V 55A	Simple Single Singola Simple	Interno Internal Interno Interne



REF	OEM	⚡		REG.
REC575011	RA097007	12V 70A	Serpentina Groove Serpentine Serpentine 65 mm	Interno Internal Interno Interne



REF	⚡		REG.
REC3860171	12V 65A	Simple Single Singola Simple	Interno Internal Interno Interne



REF	OEM	⚡
REC575010	RA097007	12V 70A



**SOLENOIDES**                      **SOLENOID**                      **SOLENOIDE**                      **SOLENOIDE**

REF	OEM
REC3853839	R130001



REF	OEM
REC3853839	R130001

**POWER TRIM**

**LATIGUILLOS**                      **HOSES**                      **TUBI**                      **TUYAU**

REF	OEM
REC32-86036	R085035



REF	OEM
REC32-86036	R085035

**ADAPTADOR GOMA**                      **BUSHING**                      **ADATTATORE IN GOMMA**                      **ADAPTATEUR EN CAOUTCHOUC**

REF	OEM
REC23-99291	R094020A



REF	OEM
REC23-99291	R094020A

**COMPONENTES DE COLA**                      **GEARHOUSING COMPONENTS**                      **COMPONENTI PIEDE**                      **COMPOSANTS D'EMBASSES**

REF	OEM
REC12-835467Q01	R096116



REF	OEM
REC897367	R096081



REF	OEM
REC90301-ZW1-003	R017066



REF	OEM
REC90508-ZW1-003	R096117



# RENAULT COUACH

## FILTRO ACEITE

## OIL FILTER

## FILTRO OLIO

## FILTRE D'HUILE

REF	
RECF425	2.60-3.90



REF	
RECF536	RCD16 RC75D



REF	
RECF477	RC130D



REF	
RECF346	RC100JET



REF	
REC3517857	4 CYL Sterndrive



REF	
RECF143	RC140D-RC210D



REF	
RECF436	RC75D



## IMPULSORES

## IMPELLER

## GIRANTE

## TURBINE

OEM	PALAS BLADES PALE PALES	JOHNSON	CEF	RECMAR	A (mm)	B (mm)	C (mm)
48300006	8		CEF500128		17	66	32
48300007	8		CEF500122T		17	65	48,6
48300037	6		CEF500127		10	50,8	22,1
48300055	8						
RC320D	8	JOH09-1028B	CEF500106GT	REC3841697	14,29	65	50,2

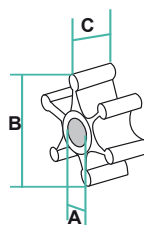

REC3841697











CEF500128



CEF500122T



CEF500127

ÁNODOS		ANODES		ANODI		ANODES	
							
TEN02090	12	TEN02090T	18X15	15	22	15	22
							
REF							
TEN01804							
REF							
TEN00490							
REF							
TEN00495							

REF	KG	Ø eje	h (mm)	m (mm)	Ø (mm)
TEN01801	0,075 kg / 0.17 lb	22 - 25	36	16 x 2	27
TEN01802	0,145 kg / 0.32 lb	28 - 34	47	20 x 2,5	35
TEN01803	0,28 kg / 0.62 lb	40	48	28 x 2,5	41
TEN00490	0,31 kg / 0.68 lb	40	50	M20	40
TEN00491	0,3 kg / 0.66 lb	40	50	M24	40
TEN00492	0,295 kg / 0.65 lb	40	50	M27	40
TEN00493	0,265 kg / 0.58 lb	40	50	M30	40
TEN00494	0,31 kg / 0.68 lb	40	52	20 x 2	40
TEN00495	0,28 kg / 0.62 lb	40	50	26 x 2	40

SOLE DIESEL

IMPULSORES		IMPELLER		GIRANTE		TURBINE		
OEM	PALAS BLADES PALE PALES	JOHNSON	CEF	RECMAR	A (mm)	B (mm)	C (mm)	
347.11.008	8	SM-75 (72 HP) SM-90 (88 HP) HS-121 (115 HP) HS-270 (270 HP) 150 (165 HP)	JOH09-1028B	CEF500106GT	REC3841697	14,29	65	50,2
351.11.008	12	MINI - 50	JOH09-1027B	CEF500107T	REC21213660	14,29	57	31,6
312.11.008	6	MINI - 11 / 17 / 23 MINI - 26 / 34 / 48		CEF500123X		12	52	25
321.11.008	6	MINI-11 (11 HP) MINI-17 (16 HP) MINI-26 (25 HP) MINI-34 (31 HP) MINI-48 (45 HP)		CEF500131X		10	39,6	19,2





REC3841697



REC21213660



CEF500123X



CEF500131X

ÁNODOS		ANODES		ANODI		ANODES	
ANODO	OEM	KG (kg / lb)	Ø eje	h (mm)	Ø (mm)	Ø1 (mm)	
TEN00400SOLE/1	40030092	0,120 / 0.26	30	39	24	32	
TEN00400SOLE/2	50035092	0,20 / 0.44	35	46	26	37	
TEN00400SOLE/3	40045092	0,40 / 0.88	45	60	36	47	
TEN00400SOLE/4	40050092	0,56 / 1.23	50	70	45	55	

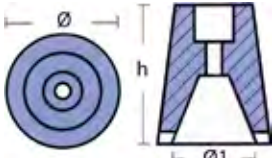

IMPULSORES

IMPELLERS

GIRANTI

TURBINE

OEM	PALAS BLADES PALE PALES	JOHNSON	CEF	RECMAR	A (mm)	B (mm)	C (mm)
IMP00301	8	JOH09-1028B	CEF500106GT	REC3841697	14,29	65	50,2
IMP00201	12	JOH09-1027B		REC21213660	14,29	57	31,6
IMP00101	6		CEF500129	REC22779-0001	12,75	50,8	22,1
IMP00701	10		CEF500146X		12,17	51,8	22
STM8061	6	JOH09-810B	CEF500101X	REC653-0001	12,17	50,8	22,1

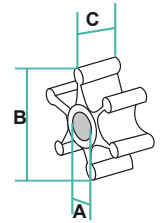

REC3841697



REC21213660



REC22779-0001



REC653-0001



CEF500146X



ÁNODOS

ANODES

ANODI

ANODES

REF	OEM	(KG / lb)	L	a	b	h	h1	i	Ø1	Ø2
TEN03510	ZINK15SC	1,00 / 2.20	152	52	68	23	29	80	11	11 x 15
TEN03511	ZINK25SC	2,40 / 5.29	250	55	75	21	37	40	11	11 x 15

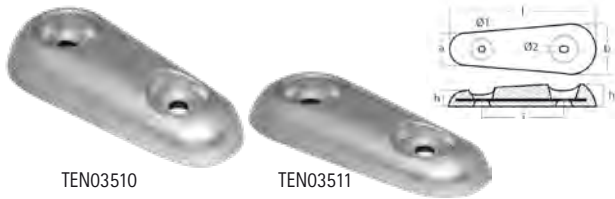

TEN03510

TEN03511

REF	OEM	(KG / lb)	Ø	h	i	Ø1	Ø1	Ø3
TEN03507	BP1185 SET0150	0,154 / 0.34	56	15	40	44	15	5



REF	OEM	(KG / lb)	Ø	a	b	h	Ø1	Ø2	Ø3
TEN03512	BP195 SET0152	0,650 / 1.43	75	25	7	47	8,5	42	55

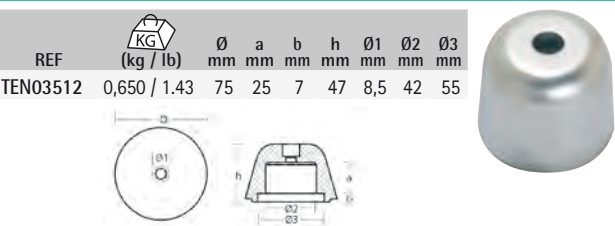

REF	OEM	(KG / lb)	Ø	a	h	h1	Ø1	Ø2	Ø3
TEN03500	BP195E SET151	0,480 / 1.06	60	24	17	42	6,5	30	12

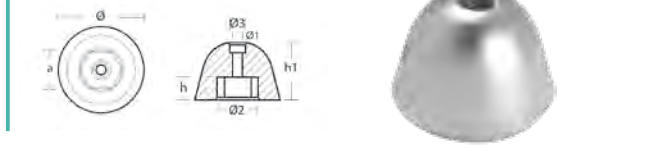

REF	OEM	(KG / lb)	Ø	c	h	h1	Ø1	Ø2	Ø3
TEN03508	BP1210 SET0152	0,380 / 0.84	50	24	41	17	10,5	6,5	33

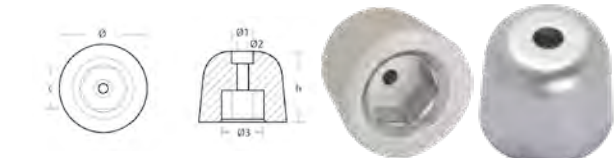

REF	OEM	(KG / lb)	Ø	l	a	b	h	h1
TEN03502	BP129 SET153	0,065 / 0.14	6,5	41	20	17	24	17

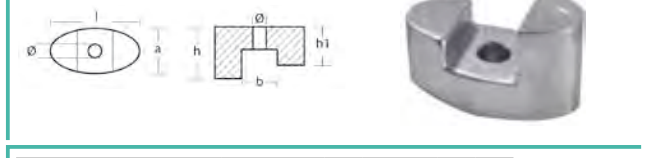

REF	OEM	(KG / lb)	Ø	a	h	Ø1	Ø1
TEN03509	BP195	0,385 / 0.85	53	28	47	11	1

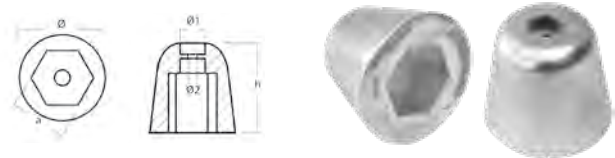



REF	OEM	(KG / lb)	Ø	h	Ø1	Ø2	Ø3
TEN03503		1,050 / 2.31	79	45	11	46	34







REF	OEM	 (kg / lb)	Ø mm	h mm	i mm	Ø1 mm	Ø1 mm	Ø3 mm
TEN03505	BP1221 SET0148	0,040 / 0.09	38	10	29	32	17	4,5

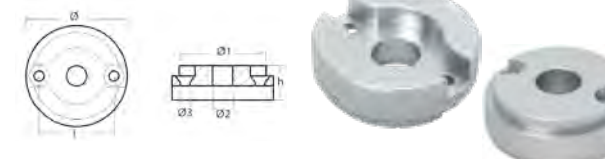

REF	OEM	 (kg / lb)	Ø mm	h mm	i mm	Ø1 mm	Ø1 mm	Ø3 mm
TEN03506	BP1126 SET0149	0,145 / 0.32	50	17	37	43	15	5,5



REF	OEM	 (kg / lb)	Ø mm	h mm	Ø1 mm	Ø2 mm	Ø3 mm
TEN00220	ZINK15C	1,000 / 2.20	148	58	27	80	31 11 x 15
TEN00221	ZINK25C	2,300 / 5.07	247	63	30	140	30 13 x 25
TEN00222		2,700 / 5.95	290	53	33	200	32 13 x 25
TEN00223	ZINK35C	4,500 / 9.92	350	68	36	200	38 13 x 25



## WESTERBEKE

### FILTRO ACEITE

### OIL FILTER

### FILTRO OLIO

### FILTRE D'HUILE

REF	OEM		50 HZ	60 HZ
REC35595	35595	M753 / G / K / W / W2	3.0 BCG	4.0 BCG
		M773	4.8 BCG	6.5 BCG
		LWZ	7.0 BTG	9.0 BTG



REF	OEM	
REC36918	36918	4.5
		5.0 10.0
		7.0 11.0
		7.2 12.5
		8.0 15
		8.5 B SERIES
		9.6



### KITS CARBURADOR

### CARBURETOR KIT

### KIT CARBURATORE

### KIT CARBURATEUR

REF	OEM	
REC36450	36450	6.5, 6.4, 4.9, 8.0 (TWG)
		8.5, 6.5, 12.5, 10.0, 15.0, 12.0 (BTG)
		16.0, 20.0, 25.0 (BEG)





### MOTOR ARRANQUE

### STARTER

### MOTORINO AVVIAMENTO

### DÉMARREUR

REF	OEM			
REC50-97499A2	33486	12 1.4 kw	9	6.5, 8.0, 11.0 (TWG) 4 Cyl Gas





**ALTERNADORES      ALTERNATORS      ALTERNATORI      ALTERNATEUR**

REF	OEM	
ARC86050	30594	12V 50A





**BOMBA AGUA      WATER PUMP      POMPA ACQUA      POMPE D'EAU**

REF	OEM			
SHER10870G	11353	3/8"	3/8"	REC3854286





REF	OEM			
REC48080	48080 37431 33636	3/8" NPT	3/8" NPT	REC653-0001



REF	OEM			BOMBA PUMP POMPA POMPE	GENER.	
RECG908	G908 G903 302648 302837	1/2"	1/2"	REC09000K	G908	M-35 35B/C M-40B M-25XPB M3-20B



**new**

REF	OEM			BOMBA PUMP POMPA POMPE	EJE SHAFT ASSE ARBRE	GENER. WESTERBEKE	GENER. FISHER PANDA	
REC10-24569-01	10-24569-01 055624 042026	3/8"	3/8"	REC27000K	F35B-8	12mm	4.2-7.0 BCG/D MCGA 55B/C/D-4	Long body pump 109 mm



**new**

**IMPULSORES      IMPELLER      GIRANTE      TURBINE**

OEM	PALAS BLADES PALE PALES	SHERWOOD	JOHNSON	CEF	RECMAR	A (mm)	B (mm)	C (mm)
302875	12	SHE09000K		CEF500165	REC09000K	15,95	62,2	22,4
11418								
11907	12	SHE09959K		CEF500103T	REC3854286	15,9	62	31,7
33104								
13930	12	SHE10615K		CEF500120T	REC10615K	15,9	65,2	41,3
11764								
33100	12	SHE10077K		CEF500166	REC10077K	12,8	56,6	19,8
48080								
37431	6		JOH09-810B	CEF500101X	REC653-0001	12,17	50,8	22,1

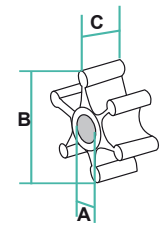

REC09000K



REC3854286



REC10615K



REC10077K





REC653-0001



**ÁNODOS ANODES ANODI ANODES**

REF	OEM
CME0	11885



**GENERADORES GENERATORS GENERATORI GENERATEURS**

	ALTERN.			TERMOST. KIT	FILTRO ACEITE OIL FILTER FILTRO OLIO FILTRE HUILE	ANODO ANODE ANODE	CARBUR. KIT
3.0 WMD(60Hz)/2.4 WMD(50Hz)		REC3586496	REC653-0001		REC36918	CME0	
3.8/4.2 BCDT(60Hz) / 3.5 BCDT(50Hz)		REC3586496	REC653-0001				
4.0 BCD(60Hz)			REC653-0001		REC36918		
4.4 BCD(60Hz)	ARC86050	REC3586496	REC653-0001	233650	REC36918	CME0	
4.4 WMD(60Hz) / 3.3 WMD(50Hz)	ARC86050			233650	REC36918	CME0	
5.0 BCD/BCDA/ BCDB(60Hz) 4.0 BCD/ BCDA/BCDB(50Hz)			REC653-0001		REC36918	CME0	
5.0 BCDR(60Hz) / 4.0 BCDR(50Hz)			REC653-0001		REC36918		
6.0 BCD(60Hz) / 4.5 BCD(50Hz)	ARC86050		REC653-0001		REC36918	CME0	
7.6 BTD(60Hz) / 5.7 BTD(50Hz)			REC653-0001		REC36918		
7.7 WMD(60Hz) / 5.8 WMD(50Hz)	ARC86050		REC653-0001	233650	REC36918		
8.0 BTD(60Hz) / 6.0 BTD(50Hz)	ARC86050			233653	REC36918		
8.0 BTDA(60Hz) / 6.0 BTDA(50Hz)		REC653-0001 (- 03/2004)	REC653-0001		REC36918		
8.0 BCDT(60Hz) / 7.0 BCDT(50Hz)			REC653-0001		REC36918	CME0	
8.0 WMD(60Hz) / 6.0 WMD(50Hz)	ARC86050		REC653-0001	233650	REC36918		
10.0 BTD(60Hz) / 7.5 BTD(50Hz)	ARC86050		REC653-0001	233653	REC36918	CME0	
10.0 BTDA(60Hz) / 7.5 BTDA(50Hz)			REC653-0001		REC36918		
11.0 BTD(60Hz) / 8.3 BTD(50Hz)	ARC86050		REC653-0001	233653			
11.0 WMD(60Hz) / 8.3 WMD(50Hz)			REC653-0001	233650	REC36918	CME0	
12.5 BTD(60Hz) / 9.4 BTD(50Hz)	ARC86050		REC653-0001	233653			
12.5 BTDA(60Hz) / 9.4 BTDA(50Hz)	ARC86050		REC653-0001	233653			
12.5 BTDB(60Hz) / 9.4 BTDB(50Hz)					REC36918		
12.5 WMD(60Hz) / 9.4 WMD(50Hz)	ARC86050		REC3854286	233650			
12.6 BTD(60Hz) / 10.4 BTD(50Hz)			REC3854286	233653	REC36918	CME0	
15.0 BTD(60Hz) / 12.0 BTD(50Hz)	ARC86050		REC3854286	233658			
15.0 BTDA(60Hz) / 12.0 BTDA(50Hz)			REC653-0001	233660			
15.0 BTDB(60Hz) / 12.0 BTDB(50Hz)			REC3854286	233660			
15.0 BTDC(60Hz) / 12.0 BTDC(50Hz)			REC3854286		REC36918		
15.0 WTA(60Hz) / 12.0 WTA (50Hz)			REC3854286	233660			
20.0 BED(60Hz) / 16.0 BED(50Hz)			REC10077K	233660			
20.0 BEDA(60Hz) / 16.0 BEDA(50Hz)			REC3854286	233660			
20.0 WTA(60Hz) / 16.0 WTA(50Hz)		REC10077K	REC3854286	233660			
25.0 BED(60Hz) / 20.0 BED(50Hz)			REC3854286	233660			
25.0 WTA(60Hz) / 20.0 WTA(50Hz)			REC3854286	233660			
32.0 BED(60Hz) / 25.0 BED(50Hz)			REC3854286				
32.0 BEDA(60Hz) / 25.0 BEDA(50Hz)			REC3854286				
4.0 BCG(60Hz)/3.0 BCG(50Hz)		REC3586496		233651	REC35595	CME0	
4.5 BCG(60Hz)/3.75 BCG(50Hz)		REC3586496		233659	REC36918	CME0	
4.5 BCGB(60Hz)/3.75 BCGB(50Hz)		REC3586496	REC3586496	233654	REC36918	CME0	
4.5 BCGTC(60Hz)/3.75 BCGTC(50Hz)		REC3586496	REC3586496	233654	REC36918	CME0	
4.5 BCGTE(60Hz) / 3.75 BCGTE(50Hz)					REC36918		
5.0 BCG(60Hz)/4.2 BCG(50Hz)		REC3586496	REC10077K	233655	REC36918	CME0	
5.0 BCGA(60Hz)/5.2 BCGA(50Hz)		REC3586496		233655	REC36918	CME0	
6.5 BCG(60Hz)/4.8 BCG(50Hz)		REC3586496		233651	REC35595	CME0	
6.5 TWG(60Hz)/4.9 TWG(50Hz)		REC10077K		233652	REC36918	CME0	REC36450
7.0 BCG(60Hz)/5.0 BCG(50Hz)		REC3586496	REC3586496	233659	REC36918	CME0	
7.0 BCGA(60Hz)/5.0 BCGA(50Hz)		REC3586496	REC3586496	233659	REC36918	CME0	
7.0 BCGB(60Hz)/6.0 BCGB(50Hz)		REC3586496		233654	REC36918	CME0	
7.0 BCGC(60Hz)/5.9 BCGC(50Hz)		REC3586496	REC3586496	233655	REC36918	CME0	
7.0 BCGD(60Hz) / 5.8 BCGD(50Hz)		REC3586496	REC10077K		REC36918	CME0	
7.2 BCGTC(60Hz)/6.0 BCGTC(50Hz)		REC3586496	REC10077K	233654	REC36918	CME0	
8.0 BEG(60Hz)/6.4 BEG(50Hz)		REC3586496	REC10077K	233656	REC36918	CME0	
8.0 TWG(60Hz)/6.4 TWG(50Hz)		REC10077K		233651	REC36918	CME0	REC36450
8.5 BTG(60Hz)/6.5 BTG(50Hz)		REC10077K		233652	REC36918	CME0	REC36450
8.5 BTGA(60Hz) / 6.8 BTGA(50Hz)		REC10077K	REC3586496		REC36918	CME0	REC36450

	ALTERN.			KIT	TERMOST. KIT	FILTRO ACEITE OIL FILTER FILTRO OLIO FILTRE HUILE	ANODO ANODE ANODO ANODE	CARBUR. KIT
9.0 BTG(60Hz)/7.0 BTG(50Hz)		REC3586496		REC10077K	233651	REC35595	CME0	
9.6 BCGTC(60Hz)/8.0 BCGTC(50Hz)		REC3586496		REC3586496	233654	REC36918	CME0	
10.0 BEG(60Hz)/8.0 BEG(50Hz)		REC3586496		REC10077K	233656	REC36918	CME0	
11.0 TWG(60Hz)/8.5 TWG(50Hz)		REC10077K		REC3586496	233651	REC36918	CME0	
12.5 BEG(60Hz)/10.0 BEG(50Hz)		REC3586496		REC10077K	233656	REC36918	CME0	
12.5 BTG(60Hz)/10.0 BTG(50Hz)		REC10077K		REC3854286	233652	REC36918	CME0	REC36450
15.0 BEG(60Hz)/12.0 BEG(50Hz)		REC3586496		REC3854286	233656	REC36918	CME0	
15.0 BTG/A(60Hz)/12.0 BTG/A(50Hz)		REC10077K		REC3586496	233652	REC36918	CME0	REC36450
20.0 BEG(60Hz)/16.0 BEG(50Hz)				REC3586496	233661	REC36918	CME0	REC36450
25.0 BEG(60Hz)/20.0 BEG(50Hz)				REC3586496	233661	REC36918	CME0	REC36450
5.0 SBCG(60Hz) / 4.0 SBCG(50Hz)		REC3586496		REC3586496	233655	REC36918	CME0	
6.5 SBCG(60Hz) / 5.4 SBCG(50Hz)		REC3586496		REC3586496	233655	REC36918	CME0	
8.0 SBEG(60Hz) / 6.4 SBEG(50Hz)		REC3586496		REC3586496	233657	REC36918	CME0	
10.0 SBEG(60Hz) / 8.0 SBEG(50Hz)		REC3586496			233657	REC36918	CME0	
12.5 SBEG(60Hz) / 10.0 SBEG(50Hz)		REC3586496			233657	REC36918	CME0	
14.0 SBEG(60Hz) / 11.6 SBEG(50Hz)		REC3586496		REC3854286	233657	REC36918	CME0	
18.0 SBEG				REC3854286		REC36918		
18.0 SBEGA				REC3854286		REC36918		
20.0 SBEG(60Hz) / 16.0 SBEG(50Hz)				REC3854286	233662	REC36918	CME0	
20.0 SBEGA(60Hz) / 16.0 SBEG(50Hz)					233662	REC36918	CME0	
22.5 SBEG(60Hz) / 18.7 SBEG(50Hz)					233662	REC36918	CME0	
22.5 SBEGA(60Hz) / 18.7 SBEGA(50Hz)					233662	REC36918	CME0	
5.5 EDC(60Hz) / 5.0 EDC(50Hz)						REC36918	CME0	



# SHERWOOD

## BOMBA AGUA



## WATER PUMP

## POMPA ACQUA



## POMPE D'EAU

REF	RECMAR			
SHEG702	RECG702	1"	1"	SHE10077K





REF				KIT MENOR KIT MINOR KIT MINEUR	KIT MAYOR KIT MAJOR KIT MAGGIORE KIT MAJEUR
SHEG155	1 1/2"	1 1/2"	SHE15000K	SHE23980	SHE23981





REF	RECMAR			
SHEG8002	RECG8002	3/8" NPT	3/8" NPT	SHE08000K





REF				KIT MENOR KIT MINOR KIT MINEUR	KIT MAYOR KIT MAJOR KIT MAGGIORE KIT MAJEUR
SHEG151	1 1/2"	1 1/2"	SHE15000K	SHE23980	SHE23981





REF	RECMAR				KIT MENOR KIT MINOR KIT MINEUR
SHEP1016	REC8M0148530	1 1/2"	1 1/2"	SHE10615K	SHE23976



REF				KIT MAYOR KIT MAJOR KIT MAGGIORE KIT MAJEUR
SHEE35	1"	1"	SHE10615K	SHE11068



REF	RECMAR				KIT MENOR KIT MINOR KIT MINEUR	KIT MAYOR KIT MAJOR KIT MAGGIORE KIT MAJEUR
SHEP1716C	RECP1716C	2"	1 3/4"	SHE17000K	SHE25124	SHE25122
SHEP1722C	RECP1722C					

SHEP1716C



SHEP1722C



REF		KIT MENOR KIT MINOR KIT MINEUR	KIT MAYOR KIT MAJOR KIT MAGGIORE KIT MAJEUR
SHEP1727C SHEP1730C	SHE17000K	SHE25124	SHE25122

Codos con brida  
Flanged Elbows  
Gomiti con fascetta  
Coude avec collier



REF				KIT MENOR KIT MINOR KIT MINEUR	KIT MAYOR KIT MAJOR KIT MAGGIORE KIT MAJEUR
SHEP176X	1 1/2"	1 3/4"	SHE17000K	SHE23973	SHE23975







REF				KIT MENOR KIT MINOR KIT MINEUR	KIT MAYOR KIT MAJOR KIT MAGGIORE KIT MAJEUR
SHEG9901	1 1/4"	1"	SHE09959K	SHE23979	SHE12665

Codos con brida  
Flanged Elbows  
Gomiti con fascetta  
Coude avec collier



REF		KIT MENOR KIT MINOR KIT MINEUR	KIT MAYOR KIT MAJOR KIT MAGGIORE KIT MAJEUR
SHEP1710C	SHE17000K	SHE25123	SHE25121



REF				KIT MENOR KIT MINOR KIT MINEUR	KIT MAYOR KIT MAJOR KIT MAGGIORE KIT MAJEUR
SHEG9903	1 1/4"	1"	SHE09959K	SHE23979	SHE12665





REF				KIT MAYOR KIT MAJOR KIT MAGGIORE KIT MAJEUR
SHEG2902X	3 3/4"	3 3/4"	SHE29000K	SHE25147





REF				KIT MENOR KIT MINOR KIT MINEUR	KIT MAYOR KIT MAJOR KIT MAGGIORE KIT MAJEUR
SHEG21	1"	1"	SHE09959K	SHE23979	SHE12665



REF		KIT MENOR KIT MINOR KIT MINEUR	KIT MAYOR KIT MAJOR KIT MAGGIORE KIT MAJEUR
SHEP1732C	SHE17000K	SHE25123	SHE25121



REF	RECMAR				KIT MENOR KIT MINOR KIT MINEUR	KIT MAYOR KIT MAJOR KIT MAGGIORE KIT MAJEUR
SHEP1014	RECP1014	1 1/4"	1 1/4"	SHE10615K	SHE23976	SHE25029





REF				KIT MENOR KIT MINOR KIT MINEUR	KIT MAYOR KIT MAJOR KIT MAGGIORE KIT MAJEUR
SHEM71	1 1/4"	1 1/4"	SHE10615K	SHE23976	SHE23977



REF				KIT MAYOR KIT MAJOR KIT MAGGIORE KIT MAJEUR
SHEG65	3/4" NPT	3/4" NPT	SHE09959K	SHE12221



REF				KIT MENOR KIT MINOR KIT MINEUR	KIT MAYOR KIT MAJOR KIT MAGGIORE KIT MAJEUR
SHEGC1 SHEGC5	1 1/2"	1 1/2"	SHE15000K	SHE23980	SHE23981

REF				KIT MAYOR KIT MAJOR KIT MAGGIORE KIT MAJEUR
SHEH5	1"	1"	SHE09959K	



REF				KIT MENOR KIT MINOR KIT MINEUR	KIT MAYOR KIT MAJOR KIT MAGGIORE KIT MAJEUR
SHEK75B	1"	1"	SHE09959K	SHE23979	SHE12665



REF		KIT MENOR KIT MINOR KIT MINEUR	KIT MAYOR KIT MAJOR KIT MAGGIORE KIT MAJEUR
SHEP2708X	SHE27000K	SHE25125	SHE25126



REF				KIT MENOR KIT MINOR KIT MINEUR	KIT MAYOR KIT MAJOR KIT MAGGIORE KIT MAJEUR
SHEL10B	1 1/4"	1 1/4"	SHE10615K	SHE23976	SHE23977



REF		KIT MENOR KIT MINOR KIT MINEUR	KIT MAYOR KIT MAJOR KIT MAGGIORE KIT MAJEUR
SHEG2603X	SHE26000K	SHE24841	SHE24842

Codos no incluidos  
Elbows not included  
Gomito non incluso  
Ne comprend pas les coudes



REF	RECMAR				KIT MAYOR KIT MAJOR KIT MAGGIORE KIT MAJEUR
SHEG1010	RECG1010	1"	1"	SHE10615K	



REF		KIT MENOR KIT MINOR KIT MINEUR	KIT MAYOR KIT MAJOR KIT MAGGIORE KIT MAJEUR
SHEG2903X	SHE29000K	SHE25044	SHE25045

Codos no incluidos  
Elbows not included  
Gomito non incluso  
Ne comprend pas les coudes



REF				KIT MAYOR KIT MAJOR KIT MAGGIORE KIT MAJEUR
SHER10870G	3/4" NPT	3/4" NPT	SHE09959K	SHE12937



REF				KIT MENOR KIT MINOR KIT MINEUR	KIT MAYOR KIT MAJOR KIT MAGGIORE KIT MAJEUR
SHEG907P	3/8" NPT	3/8" NPT	SHE09000K	SHE25195	SHE25196



REF			
SHEG8001	3/4" NPT	3/4" NPT	SHE08000K







REF			
SHEG910P	3/8" NPT	3/8" NPT	SHE09000K





Ford



GUÍA BOMBAS		PUMP GUIDE		GUIDA POMPE			GUIDE POMPE				
	OEM	BOMBA PUMP POMPA POMPE				KIT MENOR KIT MINOR KIT MINEUR	KIT MAYOR KIT MAJOR KIT MAGGIORE KIT MAJEUR	REEMPLAZA REPLACES SOSTITUISCE REMPLACE	KIT RETEN SEAL KIT KIT PARA OLIO KIT JOINT HUILE		KIT EJE SHAFT KIT KIT ASSE KIT ARBRE
Caterpillar											
3208	9Y1304	P171	40 mm	40 mm	17000K	23973	23975	Obsol.	P176X	15955	(2) 15951
3208	7E4115	P176-02	38,1 mm	40 mm	17000K	23973	23975	Blindada Proprietary Blindata Blindée	P176X	23799	(2) 15951
3116	7E3268	P172	40 mm	40 mm	17000K	23973	23975	Obsol.	P1710C	15955 15950	(2) 15951
3116	4P7168	P1710-02			17000K	23973	23975		P1710C	23799 21776	(2) 15951
3126	113-1109	P1726	Brida Clamp	Brida Clamp	17000K	23973	23975		P1726C	15955 21776	(2) 15951
3126	152-8392	P1726TC-02	Fascetta Collier	Fascetta Collier	17000K				P1726TCX	23799 21776	(2) 15951
3126	170-6116	P1732-02			17000K	23973	23975	Blindada Proprietary Blindata Blindée	P1732C	23799 21776	(2) 15951
3176	123-0500	G1805	63,5 mm	50,8 mm	18000K	24023	24024	Blindada		19878 19869	24000
3196	123-0471	G1807	63,5 mm	50,8 mm	18000K	24023	24024	Blindada		19878 19869	24001
3196	197-1328	G18071-01	63,5 mm	50,8 mm	18000K	24023	24024			23837 19869	24001
3406C	201-0956	G18061-01	63,5 mm	63,5 mm	18000K	24004	24006			23837 19869	24001
3406E	196-8895	G18081-01	95 mm	95 mm	18000K	24004	24007			23837 23045	24002
Chrysler Marine											
318 Et 360	4142878	G7	31,8 mm	31, mm	10615K	23976	23977	Obsol.		12859	(2) 23448
318 Et 360	4142878	G7B	31,8 mm	31,8 mm	10615K	23976	23977	Bomba SHE SHE pump Pompa SHE Pompe SHE		12859	(2) 23448
M273X, LM318X	2847630	D60	25,4 mm	25,4 mm	(2)09959K	10656	12300			10927	4257
M273X LM318X	2847631	D65	25,4 mm	25,4 mm	(2) 09959K	10656	12300		D60	10927	4257
LM318-X LM340-X	2846428	C-03			10615K	10999	11068		G7B	1092	4257
LM318-X LM340-X	3675763	G5	31,8 mm	31,8 mm	10615K	23976	23977		G7B	12859	(2) 23448
LM318-X LM340-X	3745511	G5-1	31,8 mm	31,8 mm	10615K	23976	23977	Obsol.	G7B	12859	(2) 23448
LM318-X LM340-X	3619030	F10	31,8 mm	31,8 mm	10615K	10999	11068		G50	10927	4257
LM318-X LM340-X	3619212	G50	31,8 mm	31,8 mm	10615K	23976	23977			12859	(2) 23448



	OEM	BOMBA PUMP POMPA POMPE				KIT MENOR KIT MINOR KIT MINEUR	KIT MAYOR KIT MAJOR KIT MAGGIORE KIT MAJEUR		REEMPLAZA REPLACES SOSTITUISCE REPLACE	KIT RETEN SEAL KIT KIT PARA OLIO KIT JOINT HUILE		KIT EJE SHAFT KIT KIT ASSE KIT ARBRE
Crusader (Dearborn)												
220									Bomba SHE			
270	97179	E35	25,4 NPT	25,4 NPT	10615K	10999	11068		SHE pump	10927		4257
300									Pompa SHE			
350									Pompe SHE			
Interceptor												
220		F15	19,1 NPT	19,1 NPT	09959K					R50G	10927	4257
270		S11040G	25,4 NPT	25,4 NPT	10615K	10999	11068	Obsol.		E35	10927	4257
300		B04	25,4 NPT	25,4 NPT	10615K	10999	11068			E35	10927	4257
350												
220									Blindada			
270	40050	P101	31,8 mm	31,8 mm	10615K	19301	19300		Proprietary	12859		(2) 23448
300									Blindata			
350									Blindée			
Cummins												
6B 250 HP	3920298	GC4	38,1mm	38,1 mm	15000K	23980	23981	Obsol.		GC5	12859	(2) 23448
4B CEPC										10514		
6B 250 HP	3927684	GC5-01	38,1 mm	38,1 mm	15000K	23980	23981	Blindada	GC5	12859	(2) 23448	
4B CEPC								Proprietary		10514		
4B 250 HP	3349340	G1503-01	38,1 mm	38,1 mm	15000K	23980	23256	Blindata	G1503	12859	(2) 23448	
6B	3919899	P1712	40 mm	40 mm	17000K	23972	23974	Blindée		12966		
								Obsol.	P1716C	15955	(2) 15951	
										19674		
6B	3922590	P1716B-01	50,8 mm	40 mm	17000K	23972	23974	Blindada	P1716	15955	(2) 15951	
								Proprietary		19674		
								Blindata				
								Blindée				
6C,6B	3912139	P173	40 mm	40 mm	17000K	23972	23974	Obsol.	P1722C	15955	(2) 15951	
270-450 HP										19674		
6C	3922589	P1722B-01	50,8 mm	40 mm	17000K	23972	23974	Blindada	P1722C	15955	(2) 15951	
								Proprietary		19674		
								Blindata				
								Blindée				
6C,6B	3897194	P1727FB-01			17000K	23972	23974	Obsol.	P1727C	15955	(2) 15951	
270-450 HP										19674		
6C,6B	3866493	P1730F-01	Brida Clamp	Brida Clamp	17000K	23972	23974	Blindada	P1730C	15955	(2) 15951	
270-450 HP			Fascetta	Fascetta				Blindata		19674		
6C	4003526	P1731F-01	Collier	Collier	17000K	23972	23974	Blindée	P1730C	15955	(2) 15951	
								Blindada		19674		
QSM11	3349392	G1810-01			18000K	24005	24008		G1810	23512		24003
										19869		
Kohler												
Ford	344089	G907P-01	9,5 NPT	9,5 NPT	09000K				Bomba SHE	G907P	22546	(2) 23448
4-6.5 KW Gas	344371	G907-01	9,5 NPT	9,5 NPT	09000K				SHE pump	G907P	22546	(2) 23448
5-7 KW Diesel	359341	GP8001	9,5 NPT	9,5 NPT	08000K				Pompa SHE		23459	(2) 23323
									Pompe SHE			
Mercruiser												
7.3 Diesel	L/270	G151	38,1 mm	38,1 mm	15000K	23980	23981		Bomba SHE		12859	(2) 23448
									SHE pump			
7.3 Diesel	L/270	G155	38,1 mm	38,1 mm	15000K	23980	23981		Pompa SHE		12859	(2) 23448
									Pompe SHE			
Onan												
4 Cil Diesel	132-0275	K75	25,4 mm	25,4 mm	09959K	23979	12665	Obsol.	K75B	12859	(2) 23448	
4 Cil Diesel	132-0276	K75B	25,4 mm	25,4 mm	09959K	23979	12665		Bomba SHE		12859	(2) 23448
									SHE pump			
									Pompa SHE			
									Pompe SHE			
5 Cil Diesel	132-0278	L10	31,8 mm	31,8 mm	10615K	23976	23977	Obsol.	L10B	12859	(2) 23448	
5 Cil Diesel	132-0278	L10B	31,8 mm	31,8 mm	10615K	23976	23977		Bomba SHE		12859	(2) 23448
									SHE pump			
									Pompa SHE			
									Pompe SHE			
5 Cil Diesel	132-0343	G1004	25,4 mm	25,4 mm	10615K	10615K	22014	Obsol.	G1006	21208, 21209	(2) 23448	
5 Cil Diesel	132-0347	G1005	25,4 mm	25,4 mm	10615K	10615K	22014	Obsol.	G1006	21208, 21209	(2) 23448	
OMC												
In Board	981939	G45-2	31,8 mm	31,8 mm	10615K	23976	23977	Obsol.	G46	12859	(2) 23448	
V8 Chevy	985096	G46	31,8 mm	31,8 mm	10615K	23976	23977	Obsol.		12859	(2) 23448	
6-8 Cil	3852398	G9901	31,8 mm	25,4 mm	09959K	23979	12665		Bomba SHE		12859	(2) 23448
									SHE pump			
									Pompa SHE			
									Pompe SHE			
4 Cil	3852399	G9902	31,8 mm	25,4 mm	09959K	23979	12665	Obsol.	G9903	12859	(2) 23448	
4 Cil	3855079	G9903	31,8 mm	25,4 mm	09959K	23979	12665		Bomba SHE		12859	(2) 23448
									SHE pump			
									Pompa SHE			
									Pompe SHE			
Perkins Engine U.S.												
40-108 Diesel	NA003335	G65	19,1 NPT	19,1 NPT	09959K	09959K	12221		Bomba SHE	10514	(2) 23448	
4-154 Diesel	NA005576	H5	25,4 mm	25,4 mm	09959K	12981	12980		SHE pump	10514, 06602	(2) 4257	
6-354 Diesel	NA001175	RPBC	25,4 NPT	25,4 NPT	10615K	10999	11068		Pompa SHE	10927	4257	
									Pompe SHE			
									Bomba SHE			

	OEM	BOMBA PUMP POMPA POMPE				KIT MENOR KIT MINOR KIT MINEUR	KIT MAYOR KIT MAJOR KIT MAJEUR	REEMPLAZA REPLACES SOSTITUISCE REMPLACE	KIT RETEN SEAL KIT KIT PARAOLIO KIT JOINT HUILE		KIT EJE SHAFT KIT KIT ASSE KIT ARBRE
Pleasurecraft Marine											
Chevy 454	G55-2	31,8 mm	31,8 mm	10615K	23976	23977	Bomba SHE SHE pump Pompa SHE Pompe SHE		12859	(2) 23448	
302 - 351	G20	25,4 mm	25,4 mm	09959K	23979	12665	Obsol.	G21	12859	(2) 23448	
302 - 351	G21-01	25,4 mm	25,4 mm	09959K	23979	12665		G21	12859	(2) 23448	
Mitsubishi 4 Cil	G22-01	-	-	09959K	23979	12665		G22	12859	(2) 23448	
7.3L Diesel	G26-01	31,8 mm	31,8 mm	10615K	23976	23977	Blindada Proprietary Blindata Blindée	G26	12859	(2) 23448	
350 GM	P105-01	31,8 mm	31,8 mm	10615K	10615K	19354		P105	18652	(2) 08490	
5.7L V8 GM	P1012-01	31,8 mm	31,8 mm	10615K	19301	19300			12859	(2) 23448	
8.1L V8 GM	P109	31,8 mm	31,8 mm	10615K	10615K	19354			18652	(2) 08490	
Volvo Penta											
	G30-2	25,4 mm	25,4 mm	09959K	23979	12665	Bomba SHE SHE pump Pompa SHE Pompe SHE		12859	(2) 23448	
	G85	31,8 mm	31,8 mm	10615K	23976	23977			12859	(2) 23448	
6-8 Cil	3852398 G9901	31,8 mm	25,4 mm	09959K	23979	12665			12859	(2) 23448	
4 Cil	3852399 G9902	31,8 mm	25,4 mm	09959K	23979	12665	Obsol.	G9903	12859	(2) 23448	
4 Cil	3855079 G9903	31,8 mm	25,4 mm	09959K	23979	12665	Bomba SHE SHE pump Pompa SHE Pompe SHE		12859	(2) 23448	
J.H. Westerbeke Corp.											
Pilot 10-20	16423 F85-01	12,7 NPT	12,7 NPT	09959K		12221	Blindada Proprietary Blindata Blindée		10514	(2) 23448	
Gov Life Boat	11353 R10870G-01	19,1 NPT	19,1 NPT	09959K	10997	12937	Bomba SHE SHE pump Pompa SHE Pompe SHE	R10870G	10927	4257	
Gov Life Boat	302648 G903	12,7 NPT	12,7 NPT	09000K			Obsol.	G908-01	12859 18806	(2) 23448	
Gov Life Boat	42175 G908-01	12,7 NPT	12,7 NPT	09000K			Blindada Proprietary Blindata Blindée		12859 18806	(2) 23448	

EXTRACTOR DE IMPULSORES	IMPELLERS EXTRACTOR	ESTRATTORE GIRANTI	EXTRACTEUR DE TURBINES																
<table border="1"> <thead> <tr> <th>REF</th> <th></th> </tr> </thead> <tbody> <tr> <td>17000</td> <td></td> </tr> <tr> <td>18000</td> <td></td> </tr> <tr> <td>SHE25105</td> <td>22000</td> </tr> <tr> <td></td> <td>26000</td> </tr> <tr> <td></td> <td>29000</td> </tr> <tr> <td></td> <td>30000</td> </tr> <tr> <td>SHE25106</td> <td>27000</td> </tr> </tbody> </table>	REF		17000		18000		SHE25105	22000		26000		29000		30000	SHE25106	27000			
REF																			
17000																			
18000																			
SHE25105	22000																		
	26000																		
	29000																		
	30000																		
SHE25106	27000																		
	SHE25106		SHE25105																

## IMPULSORES

## IMPELLERS

## GIRANTE

## TURBINE

SHERWOOD da tres sugerencias sencillas para instalar un impulsor nuevo:

- 1 Use un lubricante con base NO derivada del petróleo (por ejemplo, silicona o agua jabonosa) para instalar el impulsor de una forma más sencilla.
- 2 Instale el impulsor en el eje con un movimiento rotatorio. Nunca fuerce el impulsor sobre el eje. Debe moverse libremente sobre el eje para un cebado y funcionamiento adecuados.
- 3 Aplique una pequeña cantidad de lubricante con base NO derivada del petróleo para fijar el aro tórico en su sitio y colóque la tapa.

SHERWOOD recomienda inspeccionar detenidamente el impulsor al realizar el mantenimiento de la bomba. Reemplace el impulsor si observa lo siguiente: desgarrado o rotura en alguna de las palas del impulsor. Flexione las palas para poder examinarlas mejor.

**EL RECALENTAMIENTO ES LA CAUSA PRINCIPAL DEL DESGASTE PREMATURO DEL MOTOR.**

Sherwood suggests three easy tips to help you install your new impeller:

- 1 Use a Non-petroleum based lubricant (i.e. silicone or soapy water) to help slide the impeller.
- 2 Install the impeller with a twisting motion onto the shaft. Never force the impeller onto the shaft. The impeller must move freely on the shaft to properly prime and function.
- 3 Use a small amount of Non-petroleum based lubricant to help hold the o-ring when replacing the cover.

SHERWOOD recommends inspecting your impeller closely during any pump maintenance. Replace the impeller if you discover either of the following: tear or rip on any of the impeller blades. Flex the blades to examine more thoroughly.

**THE 1 REASON FOR PREMATURE ENGINE WEAR IS OVERHEATING.**

SHERWOOD consiglia tre semplici accorgimenti per l'installazione di una girante nuova:

- 1 Utilizzare un lubrificante con una base che Non derivi dal petrolio (per esempio silicone, o acqua insaponata).
- 2 Montare la girante con un movimento rotatorio, tenendo conto che essa deve muoversi liberamente per un corretto funzionamento. Non spingere mai la girante sopra l'asse.
- 3 Applicare una piccola quantità di lubrificante, posizionare l'anello di tenuta nella posizione corretta, quindi, procedere a montare il coperchio.

SHERWOOD raccomanda ispezionare attentamente la girante, e si osserva il seguente: strappatura o rottura di una o più pale, provvedere a sostituirla.

**IL RISCALDAMENTO È LA CAUSA PRINCIPALE DEL CONSUMO DEL MOTORE.**

SHERWOOD donne trois suggestions simples pour l'installation d'une nouvelle turbine :

- 1 Utilisez un lubrifiant NON à base de pétrole (par exemple, du silicone ou de l'eau savonneuse) pour installer la turbine plus facilement.
- 2 Installez la turbine sur l'arbre dans un mouvement de rotation. Ne jamais forcer la turbine sur l'arbre. Elle doit bouger librement sur l'arbre pour assurer un amorçage et un fonctionnement corrects.
- 3 Appliquer une petite quantité de lubrifiant NON à base de pétrole pour fixer le joint torique en place et remettre le couvercle en place.

SHERWOOD recommande d'inspecter soigneusement la turbine lors de l'entretien de la pompe. Remplacez la turbine si vous observez les signes suivants : déchirure ou rupture de l'une des pales de la turbine. **LE RÉCHAUFFEMENT EST LA PRINCIPALE CAUSE DE L'USURE PRÉMATURÉE DU MOTEUR.**

REF	PALAS BLADES PALE PALES	EJE SHAFT ASSE ARBRE		A (mm)	B (mm)	C (mm)
SHE08000K	6	-	11	30°	11.1	40.0
SHE10077K	12	3/32"	10	45°	12.7	57.0
SHE09000K	12	3/16"	10	45°	15.9	62.5
SHE09959K	12	3/16"	10	30°	15.9	62.5
SHE10615K	12	3/16"	14		15.9	65.0
SHE15000K	12	3/16"			15.9	65.0
SHE17000K	12	3/16"			20.0	84.0
SHE27000K	12	Estr.splined			84.0	73
SHE18000K	12	Estr.splined		23.8	95.0	102
SHE26000K	12				95.0	80
SHE29000K	12	Estr.splined		23.8	95.0	102
SHE30000K	10			25	114.0	110
SHE22000K	10			25	114.0	110

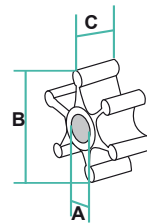

SHE26000K



SHE08000K



SHE10077K



SHE09000K



SHE09959K



SHE15000K



SHE27000K



SHE18000K



SHE17000K



SHE22000K



SHE29000K



SHE30000K



SHE10615K

GUÍA DE KITS		KITS GUIDE			GUIDA DA KIT				GUIDE DE KITS				
REF	BOMBA DE AGUA WATER PUMP POMPA ACQUA POMPE À EAU	CASQUILLO BUSHING BOCCOLA BAGUE	SELLO SEAL ASSY SIGILLANTE SIGILLANT	TÓRICA O-RING FASCIA TONDA TORIQUE		LEVA CAM CAMMA CAMME	PLACA PLATE PIASTRA PLAQUE	CHAVETA KEY CHIAVETA CLAVETTE	TAPA COVER COPERCHIO COUVERCLE	RETÉN LIP SEAL PARAOILIO JOINT HUILE	AROS RETE. RET. RINGS ANELLO TEN. BAGUE RET.	ARANDELA WASHER RONDELLA RONDELLE	EJE SHAFT ASSE ARBRE
SHE09959K	R991, B06, G65			2	1								
SHE10615K	P102, P105, P109, G1004, G1005, G1006, G1008			2	1								
	D75, D60, D65		1	2	2								
	R10870G, R10930G, R50G		1	2	1			1			1		
	E35, C-03, F10, S11040G, B04, R10970G, RPBC, F95, R102		1	1	1			1			1		
	P101, P1012		1	1	1								
SHE23972	P1712, P1716B, P173, P1722B, P1727FB, P1730F, P1731F, P1711, P1719, P1719F P171, P176, P172,		1	1	1		1	1			1		
SHE23973	P1710, P1726, P1726TC, P1732		1	1	1		1	1			1		
SHE23976	G3, G4, G5, G5-1, G7, G7B, G8, G26, G45-1, G45-2, G46, G50, G55-2, G56, G85, H-85, K90, L10, L10B, L80, L90, M71		1	2	1			1			3	1	
SHE23979	G1, G2, G15, G20, G21, G22, G30-2, G30-2B, G95-1, G9901, G9902, G9903, H10, J70, K75, K75B		1	2	1			1			3	1	
SHE23980	GC1, GC4, GC5, G157, G151, G155, G1503 G1804, G1806, G18061, G1808, G18081		1	2	1			1			3	1	
	G1810		1	2	1	2					1	1	
	G1805, G1807, G18071		1	2	1	2					1	1	
SHE11068	E35, C-03, F10, S11040G, B04, RPBC, R102	1	1	1	1	1		1			3		
SHE12221	G65, F85		2	1	1					1			
	D60, D65	1	1	1	2	2	2	1					
SHE12665	G1, G2, G15, G20, G21, G22, G30-2, G30-2B, G95-1, G9901, G9902, G9903, H10, J70, K75, K75B		2	1	2	1	1	1	1		5	1	
SHE12937	R10870G, R50G	1	1	1	2	1	1		1		4		
	H5		1	1	1	1		1		1			
SHE25029	P101, P1012		2	1	1						1		
SHE19354	P102, P105, P109		2		2	1				1	1		1
	G1503		2	2	1	1		1	1		3	1	
SHE23974	P1712, P1716B, P173, P1722B, P1727FB, P1730F, P1731F, P1711, P1719, P1719F P171, P176, P172,		2	1	1	1	1	1	1	1	3	3	
SHE23975	P1710, P1726, P1726TC, P1732		2	1	1	1	1	1	1	1	3	3	
SHE23977	G3, G4, G5, G5-1, G7, G7B, G8, G26, G45-1, G45-2, G46, G50, G55-2, G56, G85, H-85, K90, L10, L10B, L80, L90, M71	2	1	2	1	1	1	1			5	1	
SHE23981	GC1, GC4, GC5, G157, G151, G155 G1804, G1806, G18061	2	1	2	1	1	1	1			5	1	
	G1810		1	2	1	2	1		1	1	2	2	
	G1805, G1807, G18071		1	2	1	2	1		1	1	2	2	





SHE09959K



SHE10615K



SHE23972



SHE23973



SHE23976



SHE23979



SHE23980



SHE11068



SHE12221



SHE12665



SHE12937



SHE25029



SHE19354



SHE23974



SHE23975



SHE23977



SHE23981

IMPULSORES

IMPELLERS

GIRANTE

TURBINE

REF	OEM	PALAS BLADES PALE PALES	CASQUILLO BUSHING BOCCOLA BAGUE	A (mm)	B (mm)	C (mm)
JAB11979-0001	CHRYSLER	8	7	16	65	36,65
JAB12104-0001	YANMAR 128170-42070	6	2	8	32	12
JAB14750-0001		8	4	8	32	12
JAB14750-0003		8	4	8	32	12
JAB17018-0001	MERCUISER DIESEL VOLVO 3583602 CATERPILLAR 3N5895 DDA 8927570	8	7	16	65	76,2
JAB17370-0001	CUMMINS 3008503 CATERPILLAR 3N-4859 VOLVO 801277, 825941, 877061-2	12	5	25	95	88,9
JAB17937-0001-P	CATERPILLAR 7C-3286 YANMAR 127610-42200 PERKINS 0460024, 24880031	10	7	16	65	51
JAB17938-0001-P	VOLVO 3830663	12	7	25	95	95
JAB17956-0001		10	6	16	65	51
JAB18777-0001-P		10	7	16	57	51
JAB18786-0001		9	5	25	118	88,9
JAB18789-0001		9	7	25	118	88,9
JAB3085-0001	CHRIST-CRAFT FORD 18830-1020, 18840-1010 PERKINS USA 24880190	10	7	16	57	31,5
JAB30919-0001		12	5	20	77	76,2
JAB4527-0001		6	2	8	51	22
JAB5616-0001	WESTERBEKE 5320-0011	6	6	12,7	51	22

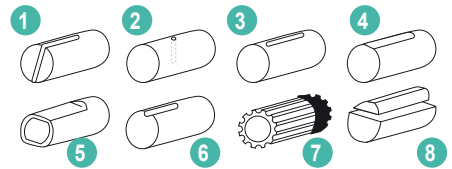
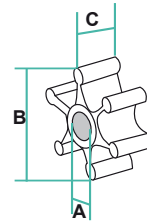

GUÍA IMPULSORES

IMPELLERS GUIDE

GUIDA GIRANTE

GUIDE TURBINE



PIN DRIVE

PALAS BLADES PALE PALES	 (mm)			RECMAR	CEF	JOHNSON	SHERWOOD	JABSCO	VOLVO	MERCURISER	YANMAR	VETUS	PERKINS	SOLE Diesel	NANNI Diesel	ONAN	WESTERBEKE
	A	B	C														
6	9,54	39,6	18,94	REC3586494	CEF500100GX	JOH09-806B	9979	4528-0001-P	3586494		104211-42071	IMPO0501	24880272			132-0859	
6	9,54	39,6	18,94	REC3586494	CEF500200GX	JOH09-806B	9979	4528-0001-P	3586494		104211-42071	IMPO0501	24880272			132-0859	
6	10	39,6	19,2		CEF500131X									321.11.008			
6	12	39,6	19,2	REC3586496	CEF500121GX	JOH09-808B		22405-0001	3586496			IMPO0601			434013	132-0310	32620
6	12	52	25		CEF500123X									312.11.008			
6	12,17	50,8	22,1	REC653-0001	CEF500101X	JOH09-810B		653-0001			128990-42200	STM8061			434014		33636
6	12,17	50,8	22,1	REC653-0001	CEF500201	JOH09-810B		653-0001			128990-42200	STM8061			434014		
6	12,66	50,8	22,1	REC3593659	CEF500116GX	JOH09-1026B		673-0001	3593659	47-810567		IMPO0901	24880194				34440
6	12,66	50,8	22,1	REC3593659	CEF500216	JOH09-1026B		673-0001	3593659	47-810567		IMPO0901	24880194				34440
10	12,17	51,8	22		CEF500146X			18653-0001-P				IMPO0701					
10	12,66	51,8	22		CEF500156GX			18673-0001									



SPLINE

PALAS BLADES PALE PALES	 (mm)			RECMAR	CEF	JOHNSON	SHERWOOD	JABSCO	VOLVO	MERCURISER	YANMAR	PLEASURECRAFT	CATERPILLAR	CUMMINS	MAN	
	A	B	C													
8	14,29	58,65	36,65	REC11979-0001	CEF500155			JAB11979-0001								
8	14,29	65	50,2	REC3841697	CEF500106GT	JOH09-1028B		920-0001	3841697	47-801332602	127610-42200	R061003E	3N1906	650607	50.06506.0091	
8	14,29	65	50,2	REC3841697	CEF500206	JOH09-1028B		920-0001			127610-42200	R061003E	3N1906	650607		
8	14,29	65,2	76,65	REC3593573	CEF500177GT			JAB17018-0001	3593573	47-816814T			3N5895			
9	22,5	95	88,5	REC6760-0001	CEF500115T	JOH09-802B		6760-0001								
9	22,5	96	63,1	REC836-0001	CEF500105T	JOH09-1029B		836-0001	21730344				1L4774	556540		
9	22,5	96	63,1	REC836-0001	CEF500205	JOH09-1029B		836-0001	875736				1L4774	556850		
9	22,5	117,6	88,5	REC18789-0001	CEF500144			JAB18789-0001								
10	14,29	65	50,1	REC17937-0001	CEF500114T		18200	JAB17937-0001-P	3588475	47-8013326-01						
10	14,29	65	50,1	REC17937-0001	CEF500214		18200	JAB17937-0001-P		47-8013326-01						
10	14,29	65	68,2	REC47-809866T	CEF500161			31130-0061		47-831311350	119593-42202					
10					CEF500172			DEV4307								
12	14,29	57	31,6	REC21213660	CEF500207	JOH09-1027B		1210-0001	21213660		129470-42532	R061003				
12	14,29	57	48,2	REC13554-0001	CEF500124	JOH09-812B		13554-0001			119773-42600					
12	12,29	57	48,2	REC21213664	CEF500178G				21213664							
12	14,29	57	50,2	REC22120-0001	CEF500104			JAB18777-0001-P	876120							
12	14,29	57,15	48,25		CEF500150			13554-6001								
12	22,5	65,8	80	REC3887761	CEF500162G	JOH09-821B			3887761		119574-42552				51.06506.0103	
12	22,5	95	63,1		CEF500135	JOH09-819B		17935-0001	21951362				5N9360			
12	22,5	95	88,5	REC875697	CEF500145T	JOH09-814B		17936-0001	21951364		165000-35270		4L8470		50.06506.0089	
12	22,5	95	95		CEF500163G			JAB17938-0001-P	3830459							
12	22,5	96,5	130	REC09-820B	CEF500186T	JOH09-820B										51.06506.0106
12						JOH09-842B										51.06506.0127

PALAS BLADES PALE PALES	 (mm)			RECMAR	CEF	JOHNSON	SHERWOOD	JABSCO	DETROIT	VETUS	PERKINS	SOLE D	YAMAHA	RENAULT	ONAN	WESTERBEKE
	A	B	C													
8	14,29	65	50,2	REC3841697	CEF500106GT	JOH09-1028B		920-0001	5193602		460024	347-11-008		RC320D		
8	14,29	65	50,2	REC3841697	CEF500206	JOH09-1028B		920-0001	5199148		24880031					
9	22,5	96	63,1	REC836-0001	CEF500105T	JOH09-1029B		836-0001	5193553	IMPO0901	460027					
9	22,5	96	63,1	REC836-0001	CEF500205	JOH09-1029B		836-0001	5193553	IMPO0901	460027					
10	14,29	65	50,1	REC17937-0001	CEF500114T		18200	JAB17937-0001-P		IMPO0301						
10	14,29	65	50,1	REC17937-0001	CEF500214		18200	JAB17937-0001-P		IMPO0301						
12	14,29	57	31,6	REC21213660	CEF500207	JOH09-1027B		1210-0001	5194205	IMPO0201	460038	351-11-008			131-0050	302571
12	14,29	57	48,2	REC13554-0001	CEF500124	JOH09-812B		13554-0001					GTA-12457-00			
12	22,5	65,8	80	REC3887761	CEF500162G	JOH09-821B										
12	22,5	95	63,1		CEF500135	JOH09-819B		17935-0001	8924838		7054					
12	22,5	95	88,5	REC875697	CEF500145T	JOH09-814B		17936-0001	5196168	IMPO0801	460027					



KEY DRIVE

PALAS BLADES PALE PALES	 (mm)			CEF	VOLVO
	A	B	C		
12	10	39,6	14,3	CEF500380	3555413



SPECIFIC DRIVE

PALAS BLADES PALE PALES	 (mm)			RECMAR	CEF	OMC
	A	B	C			
10	12,76	85,5	40,41	REC777128	CEF500317	777128



KEY DRIVE

PALAS BLADES PALE PALES	(mm)			RECMAR	CEF	JOHNSON	SHERWOOD	JABSCO	VOLVO	MERCURISER	OMC	CRUSADER	CHRIS-CRAFT	PLEASURECRAFT	YANMAR	CATERPILLAR
	A	B	C													
	6	12,75	50,8													
8	15,9	65	50,2	REC4598-0001	CEF500102T		10187	4598-0001	818680							
8	15,9	65	50,2	REC4598-0001	CEF500202		10187	4598-0001	818680							
8	15,93	65,2	50,2		CEF500160			4599-0101								
8	15,95	62,2	22,4	REC09000K	CEF500165		SHE09000K								128620-42200	
12	12,8	56,6	19,8		CEF500166		SHE10077K						16.80-90047			
12	15,9	62	31,7	REC3854286	CEF500103T	09-701	SHE09959K	18838-0001	3854286	3854286	1003026			R061015		
12	15,9	65,2	41,3	REC10615K	CEF500120T	09-702	SHE10615K	18948-0001	835874		981939	20300	16.80-90131	R061017		
12	15,93	57	31,6		CEF500208			4568-0003								
12	16	57	31,6	REC875575	CEF500170CG	JOH09-801B		6174-0001	875575						145410-46090	
12	16	65	51,2	REC15000K	CEF500167		SHE15000K	18327-0001		47-853126						
12	20,1	84	73,5	REC17000K	CEF500164T	09-704	SHE17000K	18958-0001								1W5664

PALAS BLADES PALE PALES	(mm)			RECMAR	CEF	JOHNSON	SHERWOOD	JABSCO	CUMMINS	VETUS	PERKINS	YAMAHA	RENAULT	ONAN	WESTERBEKE	KOHLER
	A	B	C													
	6	10	50,8													
6	12,75	50,8	22,1	REC22779-0001	CEF500129	09-827		22779-0001		IMP00101						229955
8	15,95	62,2	22,4	REC09000K	CEF500165		SHE09000K								302875	229826
8	17	65	48,6		CEF500122T								48300008			
8	17	66	32		CEF500128								48300007			
12	12,8	56,6	19,8		CEF500166		SHE10077K							132-0375	33112	
12	15,9	62	31,7	REC3854286	CEF500103T	09-701	SHE09959K	18838-0001			NA900010	10103-100C		132-0317	33104	
12	15,9	65,2	41,3	REC10615K	CEF500120T	09-702	SHE10615K	18948-0001	3908220		NA900012	6TA-12457-00		132-0349	33779	
12	15,93	57	31,6		CEF500208			4568-0003								
12	20,1	84	73,5	REC17000K	CEF500164T	09-704	SHE17000K	18958-0001	3802444							



SINGLE FLAT DRIVE

PALAS BLADES PALE PALES	(mm)			RECMAR	CEF	JOHNSON	SHERWOOD	JABSCO	MERCURISER	YANMAR	ONAN	KOHLER
	A	B	C									
	6	7,31	50,8									
6	7,31	50,8	22,1		CEF500210	09-824		6303-0003				
6	7,31	51,3	22		CEF500138	09-834		6303-0001				
6	7,31	51,3	22		CEF500238	09-834		6303-0001				
6	7,4	35,4	12,8		CEF500284G	09-1077						
6	8	44,6	13		CEF500132	09-1052B-9						
6	8	44,9	13		CEF500232	09-1052-S9						
6	8	31,3	11,9		CEF500113			21411-0001		128176-42071		
6	8	31,3	11,9		CEF500213			14787-0003				
6	8	31,75	12		CEF500230			1414-0003				
6	12,2	19	40	REC08000K	CEF500190G		SHE08000K				132-0415	359978
6	22,3	60	33,8	REC47-8998474	CEF500313G				47-8998474			
6	22,4	89	32,5	REC47-43026Q02	CEF500301				47-43026Q02			
8	16,85	66,5	50,6	REC47-59362Q01	CEF500109			17954-0001-P	47-59362Q01			
10	16,85	65	50,7		CEF500148			17954-0001				



DOUBLE FLAT DRIVE

PALAS BLADES PALE PALES	(mm)			RECMAR	CEF	JOHNSON	JABSCO	MERCURISER	CATERPILLAR	CUMMINS	DETROIT
	A	B	C								
	8	11,4	66,5								
9	20,2	117,6	88,5	REC18786-0001	CEF500153		JAB18786-0001		PP1027		23502086
10	13,42	57,18	50,25		CEF500157		50461-1001				
11	25,4	94	63		CEF500185	09-0838S					
12	20,2	95	88,5	REC17370-0001	CEF500152		JAB17370-0001		3N8459	3008503	8927570



PULLER DRIVE

PALAS BLADES PALE PALES	(mm)			RECMAR	CEF	SHERWOOD	YANMAR	CATERPILLAR	CUMMINS
	A	B	C						
	10	20,7	114,3						
10	24,35	114,3	109,5		CEF500193GX	SHE30000K			
12	16,1	84	73	REC27000K	CEF500181G	SHE27000K			3974456
12	20	94,5	79,8		CEF500183G	SHE26000K			3972366
12	20	94,5	101,5	REC29000K	CEF500192GX	SHE29000K	128620-42201	2968388	
12	20,7	94,5	101,5	REC18000K	CEF500182G	SHE18000K		1095327	4019403

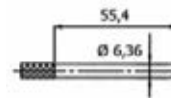

PALAS BLADES PALE PALES	(mm)			CEF	JABSCO
	A	B	C		
	6	39,1	18,9		



# REF --> OEM

REF	OEM	REF	OEM	REF	OEM
<b>A</b>		CEF500128	48300006	842	RENAULT C.
A/P2277	A4867HA	780	BORG-W.	860	JABSCO
A/P2278		780	BORG-W.	820	KOHLER
A/P2279	1308-410-001	780	BORG-W.	820	KOHLER
A/P2281		815	HURT	844	VETUS
ALT023941	100-238-002	779	BORG-W.	860	JABSCO
ALT340940	2001-238-001	779	BORG-W.	843	SOLE D.
ALTD A-101	1004-650-001	779	BORG-W.	859	JABSCO
ALTD A-102	1004-650-002	779	BORG-W.	860	JABSCO
ALTD A-107	1004-650-007	779	BORG-W.	814	DETROIT D.
ALTD A-108	1004-650-008	779	BORG-W.	823	NANNI D.
ARC86050	30594	846	WESTERB.	788	CATERPIL
ARC86050		847	WESTERB.	788	CATERPIL
<b>B</b>		CEF500135	8924838	809	CUMMINS
BACC47-1650-06022	1650-056022	790	CHRIS-C.	811	CUMMINS
BAPE-1-6354	89058	829	PERKINS	859	JABSCO
<b>C</b>		CEF500138		860	JABSCO
CEF500100GX	24880272	831	PERKINS	859	JABSCO
CEF500100GX		819	KOHLER	831	PERKINS
CEF500100GX		827	ONAN	814	DETROIT D.
CEF500100GX		830	PERKINS	788	CATERPIL
CEF500100GX		859	JABSCO	821	MAN
CEF500101X	37431	846	WESTERB.	859	JABSCO
CEF500101X	48080	846	WESTERB.	844	VETUS
CEF500101X	434014	823	NANNI D.	823	NANNI D.
CEF500101X	STM8061	844	VETUS	859	JABSCO
CEF500101X		859	JABSCO	860	JABSCO
CEF500102T		860	JABSCO	859	JABSCO
CEF500103T	11418	846	WESTERB.	814	DETROIT D.
CEF500103T	11907	846	WESTERB.	788	CATERPIL
CEF500103T	22212	800	CRUSADER	860	JABSCO
CEF500103T	33104	846	WESTERB.	814	DETROIT D.
CEF500103T	1003026	800	CRUSADER	860	JABSCO
CEF500103T	1003062	800	CRUSADER	859	JABSCO
CEF500103T	24880178	831	PERKINS	860	JABSCO
CEF500103T	132-0117	827	ONAN	859	JABSCO
CEF500103T	132-0317	827	ONAN	821	MAN
CEF500103T	NA900010	831	PERKINS	859	JABSCO
CEF500103T		820	KOHLER	821	MAN
CEF500103T		860	JABSCO	859	JABSCO
CEF500104		834	PLEASUREC.	811	CUMMINS
CEF500104		859	JABSCO	811	CUMMINS
CEF500105T	460027	831	PERKINS	811	CUMMINS
CEF500105T	5193553	814	DETROIT D.	811	CUMMINS
CEF500105T	1L4774	788	CATERPIL.	788	CATERPIL
CEF500105T		859	JABSCO	788	CATERPIL
CEF500106GT	5193602	814	DETROIT D.	860	JABSCO
CEF500106GT	5196629	814	DETROIT D.	820	KOHLER
CEF500106GT	5199148	814	DETROIT D.	846	WESTERB.
CEF500106GT	347.11.008	843	SOLE D.	860	JABSCO
CEF500106GT	3N1906	788	CATERPIL.	846	WESTERB.
CEF500106GT	50.06506.0091	821	MAN	846	WESTERB.
CEF500106GT	50.06506.0091	823	NANNI D.	827	ONAN
CEF500106GT	IMP00301	844	VETUS	827	ONAN
CEF500106GT	RC320D	842	RENAULT C.	820	KOHLER
CEF500107T	460038	831	PERKINS	860	JABSCO
CEF500107T	24880190	831	PERKINS	811	CUMMINS
CEF500107T	08-21-1201	827	ONAN	811	CUMMINS
CEF500107T	131-0050	827	ONAN	860	JABSCO
CEF500107T	132-0162	827	ONAN	860	JABSCO
CEF500107T	351.11.008	843	SOLE D.	859	JABSCO
CEF500107T		832	PERKINS	788	CATERPIL.
CEF500109		860	JABSCO	859	JABSCO
CEF500110		860	JABSCO	788	CATERPIL.
CEF500113		860	JABSCO	860	JABSCO
CEF500114T	460024	831	PERKINS	811	CUMMINS
CEF500114T	24880031	831	PERKINS	860	JABSCO
CEF500114T	7C3286	788	CATERPIL.	860	JABSCO
CEF500114T		814	DETROIT D.	788	CATERPIL.
CEF500114T		823	NANNI D.	788	CATERPIL.
CEF500114T		859	JABSCO	788	CATERPIL.
CEF500115T		859	JABSCO	811	CUMMINS
CEF500116GX	24880194	831	PERKINS	811	CUMMINS
CEF500116GX		859	JABSCO	860	JABSCO
CEF500120T	13930	846	WESTERB.	811	CUMMINS
CEF500120T	20300	800	CRUSADER	821	MAN
CEF500120T	20310	800	CRUSADER	859	JABSCO
CEF500120T	3908220	811	CUMMINS	820	KOHLER
CEF500120T	132-0292	827	ONAN	827	ONAN
CEF500120T	132-0348	827	ONAN	827	ONAN
CEF500120T	132-0349	827	ONAN	860	JABSCO
CEF500120T	NA900012	831	PERKINS	811	CUMMINS
CEF500120T	R061017	800	CRUSADER	860	JABSCO
CEF500120T		860	JABSCO	811	CUMMINS
CEF500121GX	434013	823	NANNI D.	860	JABSCO
CEF500121GX		859	JABSCO	860	JABSCO
CEF500122T	48300008	842	RENAULT C.	859	JABSCO
CEF500122T		860	JABSCO	859	JABSCO
CEF500123X	312.11.008	843	SOLE D.	860	JABSCO
CEF500123X		859	JABSCO	860	JABSCO
CEF500124		859	JABSCO	859	JABSCO
CEF500127	48300037	842	RENAULT C.	859	JABSCO
CEF500127		860	JABSCO	860	JABSCO
CEF500128		842	RENAULT C.	860	JABSCO
CEF500129	229955	820	KOHLER	860	JABSCO
CEF500129	250872	820	KOHLER	860	JABSCO
CEF500129	IMP00101	844	VETUS	860	JABSCO
CEF500129		860	JABSCO	860	JABSCO
CEF500131X	321.11.008	843	SOLE D.	860	JABSCO
CEF500131X		859	JABSCO	860	JABSCO
CEF500132		860	JABSCO	860	JABSCO
CEF500135	8924838	814	DETROIT D.	860	JABSCO
CEF500135	50.06506.0089	823	NANNI D.	860	JABSCO
CEF500135	5N9360	788	CATERPIL	860	JABSCO
CEF500135		788	CATERPIL	860	JABSCO
CEF500135		809	CUMMINS	860	JABSCO
CEF500135		811	CUMMINS	860	JABSCO
CEF500135		859	JABSCO	860	JABSCO
CEF500138		860	JABSCO	860	JABSCO
CEF500144		859	JABSCO	860	JABSCO
CEF500145T	460027	831	PERKINS	860	JABSCO
CEF500145T	5196168	814	DETROIT D.	860	JABSCO
CEF500145T	4L8470	788	CATERPIL	860	JABSCO
CEF500145T	50.06506.0089	821	MAN	860	JABSCO
CEF500146X	IMP00701	844	VETUS	860	JABSCO
CEF500146X		823	NANNI D.	860	JABSCO
CEF500146X		859	JABSCO	860	JABSCO
CEF500148		860	JABSCO	860	JABSCO
CEF500150		859	JABSCO	860	JABSCO
CEF500152	8927570	814	DETROIT D.	860	JABSCO
CEF500152	3N4859	788	CATERPIL	860	JABSCO
CEF500152		860	JABSCO	860	JABSCO
CEF500153	23502086	814	DETROIT D.	860	JABSCO
CEF500153		860	JABSCO	860	JABSCO
CEF500155		859	JABSCO	860	JABSCO
CEF500156GX		859	JABSCO	860	JABSCO
CEF500157		860	JABSCO	860	JABSCO
CEF500159G		860	JABSCO	860	JABSCO
CEF500160		860	JABSCO	860	JABSCO
CEF500161		859	JABSCO	860	JABSCO
CEF500162G	51.06505.0103	821	MAN	860	JABSCO
CEF500162G		859	JABSCO	860	JABSCO
CEF500164T	3802444	811	CUMMINS	860	JABSCO
CEF500164T	3897337	811	CUMMINS	860	JABSCO
CEF500164T	3916852	811	CUMMINS	860	JABSCO
CEF500164T	3925236	811	CUMMINS	860	JABSCO
CEF500164T	1W5664	788	CATERPIL	860	JABSCO
CEF500164T	7E0321	788	CATERPIL	860	JABSCO
CEF500165	229826	820	KOHLER	860	JABSCO
CEF500165	302875	846	WESTERB.	860	JABSCO
CEF500165		860	JABSCO	860	JABSCO
CEF500166	11764	846	WESTERB.	860	JABSCO
CEF500166	33100	846	WESTERB.	860	JABSCO
CEF500166	132-0375	827	ONAN	860	JABSCO
CEF500166	132-0498	827	ONAN	860	JABSCO
CEF500166		820	KOHLER	860	JABSCO
CEF500167	3349198	811	CUMMINS	860	JABSCO
CEF500167	3916720	811	CUMMINS	860	JABSCO
CEF500167		860	JABSCO	860	JABSCO
CEF500170CG		860	JABSCO	860	JABSCO
CEF500172		859	JABSCO	860	JABSCO
CEF500177GT	3N5895	788	CATERPIL.	860	JABSCO
CEF500177GT		859	JABSCO	860	JABSCO
CEF500178G		859	JABSCO	860	JABSCO
CEF500179GX	3N8449	788	CATERPIL.	860	JABSCO
CEF500181G	3974456	811	CUMMINS	860	JABSCO
CEF500181G		860	JABSCO	860	JABSCO
CEF500182G	1095324	788	CATERPIL.	860	JABSCO
CEF500182G	1095327	788	CATERPIL.	860	JABSCO
CEF500182G	1230492	788	CATERPIL.	860	JABSCO
CEF500182G	1237985	788	CATERPIL.	860	JABSCO
CEF500182G	4019403	811	CUMMINS	860	JABSCO
CEF500182G	4933743	811	CUMMINS	860	JABSCO
CEF500182G		860	JABSCO	860	JABSCO
CEF500183G	3972366	811	CUMMINS	860	JABSCO
CEF500183G		860	JABSCO	860	JABSCO
CEF500185		860	JABSCO	860	JABSCO
CEF500186T	51.06505.0106	821	MAN	860	JABSCO
CEF500186T		859	JABSCO	860	JABSCO
CEF500190G	359978	820	KOHLER	860	JABSCO
CEF500190G	132-0407	827	ONAN	860	JABSCO
CEF500190G	132-0415	827	ONAN	860	JABSCO
CEF500190G		860	JABSCO	860	JABSCO
CEF500192GX		811	CUMMINS	860	JABSCO
CEF500192GX		860	JABSCO	860	JABSCO
CEF500193GX		860	JABSCO	860	JABSCO
CEF500200GX		859	JABSCO	860	JABSCO
CEF500201		859	JABSCO	860	JABSCO
CEF500202		860	JABSCO	860	JABSCO
CEF500205		859	JABSCO	860	JABSCO
CEF500206		859	JABSCO	860	JABSCO
CEF500207		859	JABSCO	860	JABSCO
CEF500208		860	JABSCO	860	JABSCO
CEF500210		860	JABSCO	860	JABSCO
CEF500213		860	JABSCO	860	JABSCO
CEF500214		859	JABSCO	860	JABSCO
CEF500216		859	JABSCO	860	JABSCO
CEF500230		860	JABSCO	860	JABSCO

REF	OEM	REF	OEM	REF	OEM
JAB12104-0001	858 JABSCO	MAS011943	822 MASE	REC10615K	13930 846 WESTERB.
JAB14750-0001	858 JABSCO	MAS013432	822 MASE	REC10615K	20300 800 CRUSADER
JAB14750-0003	858 JABSCO	MAS014020	822 MASE	REC10615K	20310 800 CRUSADER
JAB17018-0001	3N5895 788 CATERPIL.	MAS018807	822 MASE	REC10615K	3908220 811 CUMMINS
JAB17018-0001	858-859 JABSCO	MAS025222	822 MASE	REC10615K	132-0292 827 ONAN
JAB17370-0001	8927570 814 DETROIT D.	MAS027318	822 MASE	REC10615K	132-0348 827 ONAN
JAB17370-0001	3N4859 788 CATERPIL.	MAS11885	822 MASE	REC10615K	132-0349 827 ONAN
JAB17370-0001	786 CATERPIL.	MAS30253	822 MASE	REC10615K	NA900012 831 PERKINS
JAB17370-0001	858-860 JABSCO	MAS31004	822 MASE	REC10615K	R061017 799-800 CRUSADER
JAB17937-0001-P	460024 831 PERKINS	MAS70196	822 MASE	REC10615K	820 KOHLER
JAB17937-0001-P	24880031 831 PERKINS	MAS71008	822 MASE	REC10615K	860 JABSCO
JAB17937-0001-P	7C3286 788 CATERPIL.	MAS71110	822 MASE	REC10615K	809-811 CUMMINS
JAB17937-0001-P	823 NANNI D.	MAS71166	822 MASE	REC10615K	825-826-827 ONAN
JAB17937-0001-P	858-859 JABSCO	MAS71183	822 MASE	REC1140639	830 PERKINS
JAB17938-0001-P	858-859 JABSCO	MAS71204	822 MASE	REC119305-35151	822 MASE
JAB17956-0001	858 JABSCO	MAS71270	822 MASE	REC11979-0001	859 JABSCO
JAB18777-0001-P	858-859 JABSCO	MAS71365	822 MASE	REC119802-55810	822 MASE
JAB18786-0001	23502086 814 DETROIT D.	MAS80159	822 MASE	REC12-835467Q01	R096116 841 PLEASUREC.
JAB18786-0001	7E3022 788 CATERPIL.	MAS910141	822 MASE	REC120	830 PERKINS
JAB18786-0001	858-860 JABSCO	MAS910207	822 MASE	REC1220550	122-0550 825 ONAN
JAB18789-0001	858-859 JABSCO	MAS910208	822 MASE	REC1220602	1220602 824 ONAN
JAB3085-0001	858 JABSCO	MAS910604	822 MASE	REC1220716712	122.0716.712 825 ONAN
JAB30919-0001	858 JABSCO	MAS911450	822 MASE	REC1220810	1220810 825 ONAN
JAB4527-0001	858 JABSCO	MAS911730	822 MASE	REC1220810	122-0810 825 ONAN
JAB5616-0001	858 JABSCO	MAS912163	822 MASE	REC1220810	16.69-00100 793 CHRIS-C.
JOH09-1026B	24880194 831 PERKINS	MAS912168	822 MASE	REC12532	16.69-00100 804 CRUSADER
JOH09-1026B	859 JABSCO	MAS912277	822 MASE	REC12532	F16900165 793 CHRIS-C.
JOH09-1027B	460038 831 PERKINS	MAS912357	822 MASE	REC12532	F16900165 804 CRUSADER
JOH09-1027B	24880190 831 PERKINS	MAS912422	822 MASE	REC12644A1	790 CHRIS-C.
JOH09-1027B	08-21-1201 827 ONAN	MAS912423	822 MASE	REC12644A1	799 CRUSADER
JOH09-1027B	131-0050 827 ONAN	MAS913347	822 MASE	REC12644A1	832 PLEASUREC.
JOH09-1027B	132-0162 827 ONAN	MAS913348	822 MASE	REC128000-5720	128000-5720 789 CATERPIL.
JOH09-1027B	351.11.008 843 SOLE D.	MAS913354	822 MASE	REC129150-35153	822 MASE
JOH09-1027B	IMP00201 844 VETUS	MAS92682	822 MASE	REC129470-55703	822 MASE
JOH09-1027B	822 MASE	MAS92892	822 MASE	REC129612-42290E	822 MASE
JOH09-1027B	823 NANNI D.	MAS92958	822 MASE	REC13554-0001	859 JABSCO
JOH09-1027B	832 PERKINS	MAS97536	822 MASE	REC1396-4148	RN0116 836 PLEASUREC.
JOH09-1027B	834 PLEASUREC.			REC1396-4148	RN0116-2 836 PLEASUREC.
JOH09-1027B	859 JABSCO			REC1396-4656	RN0116 835 PLEASUREC.
JOH09-1028B	5193602 814 DETROIT D.	OSC0959	1650-05944 790 CHRIS-C.	REC1396-4656	RN0116-2 835 PLEASUREC.
JOH09-1028B	5196629 814 DETROIT D.	OSC7169-MK	798 CRUSADER	REC1396-5238	RN0118 835 PLEASUREC.
JOH09-1028B	5199148 814 DETROIT D.	OSC7387	97387 798 CRUSADER	REC1396-5238	RN0120 835 PLEASUREC.
JOH09-1028B	347.11.008 843 SOLE D.	OSC7624	97624 798 CRUSADER	REC1397-2060	45303 802-803 CRUSADER
JOH09-1028B	3N1906 788 CATERPIL.	OSC7772-MK	798 CRUSADER	REC1397-2060	792 CHRIS-C.
JOH09-1028B	50.06506.0091 821 MAN	OSC8128-MK	797 CRUSADER	REC1397-2060	802 CRUSADER
JOH09-1028B	50.06506.0091 823 NANNI D.	OSC8243-MK	797 CRUSADER	REC1397-3327	792 CHRIS-C.
JOH09-1028B	IMP00301 844 VETUS	OSC9015G	797 CRUSADER	REC1463-9382	37068 802-803 CRUSADER
JOH09-1028B	RC320D 842 RENAULT C.	OSC994-MK	816 INDMAR	REC1463-9382	37068 807 CRUSADER
JOH09-1028B	859 JABSCO			REC1463-9382	51080 795 CHRIS-C.
JOH09-1029B	460027 831 PERKINS	RACR12	830 PERKINS	REC1463-9382	51080 807 CRUSADER
JOH09-1029B	5193553 814 DETROIT D.	REC016940	879194241 815 HURT	REC1463-9382	R117001 839 PLEASUREC.
JOH09-1029B	1L4774 788 CATERPIL.	REC016940	8791014241 815 HURT	REC1463-9382	817 INDMAR
JOH09-1029B	859 JABSCO	REC016940	35-813405 815 HURT	REC149-0428	149-0428 824-828 ONAN
JOH09-801B	860 JABSCO	REC016940	35-813405A1 815 HURT	REC149-2106	149-2106 824 ONAN
JOH09-802B	816 INDMAR	REC016940	35-815419 815 HURT	REC149-2106	A026K278 828 ONAN
JOH09-802B	859 JABSCO	REC016940	F19608751 815 HURT	REC1491754	1491754 824 ONAN
JOH09-806B	24880272 831 PERKINS	REC016940	FFF001138 815 HURT	REC1491758	1491758 824 ONAN
JOH09-806B	132-0859 827 ONAN	REC08000K	359978 819 KOHLER	REC1492250I	1492250 824 ONAN
JOH09-806B	132B59 827 ONAN	REC08000K	132-0407 827 ONAN	REC1492251II	1492251 II 824 ONAN
JOH09-806B	859 JABSCO	REC08000K	132-0415 826 ONAN	REC15-401	818 INDMAR
JOH09-808B	434013 823 NANNI D.	REC08000K		REC15-405	818 INDMAR
JOH09-808B	822 MASE	REC08000K		REC15-601	808 CRUSADER
JOH09-808B	859 JABSCO	REC08000K		REC15-601	818 INDMAR
JOH09-810B	37431 846 WESTERB.	REC09-820B		REC15-602	818 INDMAR
JOH09-810B	48080 846 WESTERB.	REC09000K	229826 819 KOHLER	REC15-604	808 CRUSADER
JOH09-810B	434014 823 NANNI D.	REC09000K	302875 846 WESTERB.	REC15-604	818 INDMAR
JOH09-810B	STM8061 844 VETUS	REC09000K		REC15-801	839 PLEASUREC.
JOH09-810B	822 MASE	REC09000K		REC15-801	839 PLEASUREC.
JOH09-810B	859 JABSCO	REC09000K		REC15-805	808 CRUSADER
JOH09-812B	822 MASE	REC09000K		REC15-806	818 INDMAR
JOH09-812B	859 JABSCO	REC09140	NA001175 820-821 KOHLER	REC15-806	839 PLEASUREC.
JOH09-814B	5196168 814 DETROIT D.	REC0985964		REC15000K	3349198 811 CUMMINS
JOH09-814B	4L8470 788 CATERPIL.	REC10-24569-01	42026 846 WESTERB.	REC15000K	3916720 811 CUMMINS
JOH09-814B	50.06506.0089 821 MAN	REC10-24569-01	55624 846 WESTERB.	REC17000K	3802444 811 CUMMINS
JOH09-814B	50.06506.0089 823 NANNI D.	REC10-24569-01	10-24569-01 846 WESTERB.	REC17000K	3897337 811 CUMMINS
JOH09-814B	821 MAN	REC10-24569-01		REC17000K	3916852 811 CUMMINS
JOH09-814B	859 JABSCO	REC10-24570-01	20639 822 MASE	REC17000K	3925236 811 CUMMINS
JOH09-819B	8924838 814 DETROIT D.	REC10-24570-01	10-24570-01 822 MASE	REC17000K	1W5664 788 CATERPIL.
JOH09-819B	5N9360 788 CATERPIL.	REC10-24571-01	20291 814 FISHER P.	REC17000K	7E0321 788 CATERPIL.
JOH09-819B	859 JABSCO	REC10-24571-01	20291 822 MASE	REC17000K	786 CATERPIL.
JOH09-820B	51.06505.0106 821 MAN	REC10-24571-01	10-24571-01 814 FISHER P.	REC17000K	860 JABSCO
JOH09-820B	51.06506.0106 823 NANNI D.	REC10-24571-01	10-24571-01 822 MASE	REC17000K	810-811 CUMMINS
JOH09-821B	51.06505.0103 821 MAN	REC10-35127-3	060-068-0-0-B 814 FISHER P.	REC17000K	811 CUMMINS
JOH09-821B	51.06506.0103 823 NANNI D.	REC10-35127-3	10-35127-3 814 FISHER P.	REC17000K	811 CUMMINS
JOH09-821B	859 JABSCO	REC10-35127-3	FP1-000410 814 FISHER P.	REC17000K	811 CUMMINS
JOH09-842B	51.06505.0127 821 MAN	REC10077K	11764 846 WESTERB.	REC17000K	788 CATERPIL.
JOH09-842B	859 JABSCO	REC10077K	33100 846 WESTERB.	REC17000K	786 CATERPIL.
MAG15-803	808 CRUSADER	REC10077K	727103 800 CRUSADER	REC17000K	860 JABSCO
MAG15-803	818 INDMAR	REC10077K	132-0375 827 ONAN	REC17000K	809-810-811 CUMMINS
MAG15-809	818 INDMAR	REC10077K	132-0498 827 ONAN	REC17010	33408 795 CRUSADER
MAG15-809	839 PLEASUREC.	REC10077K		REC17030	6269577 832 PLEASUREC.
MAR345	3776F024 829 PERKINS	REC10077K		REC17030	7057500 795 CRUSADER
MAR906	135616660 829 PERKINS	REC10077K		REC17030	16.50-00250 790 CHRIS-C.
				REC17040	30266 795 CRUSADER



REF	OEM	REF	OEM	REF	OEM
REC17042	31136	795 CRUSADER	REC27000K	3974456	811 CUMMINS
REC17046	16.50-00259	790 CHRIS-C.	REC27000K		846 WESTERB.
REC17048	31137	795 CRUSADER	REC27000K		860 JABSCO
REC17177A1	37061	806 CRUSADER	REC29000K		811 CUMMINS
REC17177A1		794 CHRIS-C.	REC29000K		860 JABSCO
REC17177A1		838 PLEASUREC.	REC29000K		786-787 CATERPIL.
REC17310	33393	796 CRUSADER	REC29350-1001	GM58527	819 KOHLER
REC17370-0001	8927570	814 DETROIT D.	REC29350-1001	M20	830 PERKINS
REC17920	97686	860 JABSCO	REC296TWIN		830 PERKINS
REC17930	91351	796 CRUSADER	REC300-00879		795 CHRIS-C.
REC17937-0001	460024	796 CRUSADER	REC300-00879		807 CRUSADER
REC17937-0001	24880031	831 PERKINS	REC300-0539	1W6586	839 PLEASUREC.
REC17937-0001		831 PERKINS	REC300-0539	8N2250	785 CATERPIL.
REC17937-0001		823 NANNI D.	REC32-86036	R085035	841 PLEASUREC.
REC17937-0001		859 JABSCO	REC3302-9031		802-803 CRUSADER
REC18-5295		813-814 DETROIT D.	REC33662	41057	793 CHRIS-C.
REC18-8112		839 PLEASUREC.	REC33662	41057	805 CRUSADER
REC18-8114		800 CRUSADER	REC33662	705787	805 CRUSADER
REC18-8114		792 CHRIS-C.	REC33662	755017	817 INDMAR
REC18-8114		802 CRUSADER	REC33662	16.69-00050	793 CHRIS-C.
REC18-8115		816 INDMAR	REC33662	R115002	837 PLEASUREC.
REC18-8115		792 CHRIS-C.	REC33706	12526	805 CRUSADER
REC18000K	1095324	816 INDMAR	REC33706		793 CHRIS-C.
REC18000K	1095327	788 CATERPIL.	REC33708	12528	804 CRUSADER
REC18000K	1230492	788 CATERPIL.	REC33765T		792 CHRIS-C.
REC18000K	1237985	788 CATERPIL.	REC33765T		804 CRUSADER
REC18000K	4019403	811 CUMMINS	REC34235T	16.69-00049	793 CHRIS-C.
REC18000K	4933743	811 CUMMINS	REC34235T		805 CRUSADER
REC185-2133	185-2133	825 ONAN	REC3423A1		794 CHRIS-C.
REC1855835	1855835	824 ONAN	REC344085	344085	806 CRUSADER
REC1855835	185-5835	824 ONAN	REC344085	344371	819 KOHLER
REC1855835		814 FISHER P.	REC34765A2		819 KOHLER
REC1855835		828 ONAN	REC34765A2		790 CHRIS-C.
REC1870014	187.0014	825 ONAN	REC34765A2		799 CRUSADER
REC18786-0001	23502086	813 DETROIT D.	REC35-06003	201104	832 PLEASUREC.
REC18786-0001		859-860 JABSCO	REC35-06003	16.81-08746	801 CRUSADER
REC21213660	252882	820 KOHLER	REC35-06003	R077002	791 CHRIS-C.
REC21213660	460038	831 PERKINS	REC35-06003		835 PLEASUREC.
REC21213660	24880190	831 PERKINS	REC35-06007	9002514	825 ONAN
REC21213660	08-21-1201	827 ONAN	REC35-06007	1R-16.81-06536	801 CRUSADER
REC21213660	131-0050	827 ONAN	REC35-06007	R077001	791 CHRIS-C.
REC21213660	132-0162	827 ONAN	REC35-816168	2654347	835 PLEASUREC.
REC21213660	351.11.008	843 SOLE D.	REC35-816168	2654407	829 PERKINS
REC21213660	IMP00201	844 VETUS	REC35-8M0061975	98041	801 CRUSADER
REC21213660		787 CATERPIL.	REC3517857		801 CRUSADER
REC21213660		814 FISHER P.	REC3517857		835 PLEASUREC.
REC21213660		816 INDMAR	REC3517857		842 RENAULT C.
REC21213660		822 MASE	REC355595	35595	845-847- WESTERB.
REC21213660		823 NANNI D.	REC3581078	2656017	848 WESTERB.
REC21213660		832 PERKINS	REC3586494	24880272	830 PERKINS
REC21213660		859 JABSCO	REC3586494		831 PERKINS
REC21302969	185086610	832 PERKINS	REC3586494	434013	827 ONAN
REC21302969	185086620	832 PERKINS	REC3586496		859 JABSCO
REC21323043	185086600	832 PERKINS	REC3586496		823 NANNI D.
REC21323043	163-3361	789 CATERPIL.	REC3586496		814 FISHER P.
REC21622232		838 PLEASUREC.	REC3586496		847 WESTERB.
REC21707134	1R-0658	785 CATERPIL.	REC3586496		848 WESTERB.
REC21730344	50.06506.0089	823 NANNI D.	REC3593573	3N5895	859 JABSCO
REC21730344	5N9360	788 CATERPIL.	REC3593573		788 CATERPIL.
REC22000K		860 JABSCO	REC3593659	24880194	859 JABSCO
REC22040-0701S	65.00600.0016	821 MAN	REC3604654RX	3604654RX	812 CUMMINS
REC22120-0001		859 JABSCO	REC36450	36450	845-847- WESTERB.
REC222779-0001	229955	820 KOHLER	REC36918	36918	848 WESTERB.
REC222779-0001	250872	820 KOHLER	REC36918		845 WESTERB.
REC222779-0001	IMP00101	844 VETUS	REC36918		820 KOHLER
REC222779-0001		860 JABSCO	REC3841697	5193602	847-848 WESTERB.
REC222779-0001		820-821 KOHLER	REC3841697	5196629	814 DETROIT D.
REC229678	229678	818 KOHLER	REC3841697	5199148	814 DETROIT D.
REC23-3666		819 KOHLER	REC3841697	347.11.008	843 SOLE D.
REC23-99291	R094020A	841 PLEASUREC.	REC3841697	3N1906	788 CATERPIL.
REC23535447	23525200	813 DETROIT D.	REC3841697	50.06506.0091	821 MAN
REC23535447	23535477	813 DETROIT D.	REC3841697	50.06506.0091	823 NANNI D.
REC252898	252898	819-820 KOHLER	REC3841697	IMP00301	844 VETUS
REC2656613		830 PERKINS	REC3841697	RC320D	842 RENAULT C.
REC26901		794 CHRIS-C.	REC3841697		859 JABSCO
REC26901		807 CRUSADER	REC3841697		820-821 KOHLER
REC26901		839 PLEASUREC.	REC3841697		836 PLEASUREC.
REC26904		794 CHRIS-C.	REC3850397	R084003	803 CRUSADER
REC26904		807 CRUSADER	REC3850559	47002	801 CRUSADER
REC26904		839 PLEASUREC.	REC3850559	201104	792 CHRIS-C.
REC26905		794 CHRIS-C.	REC3850559		835 PLEASUREC.
REC26905		807 CRUSADER	REC3852455	RM0007	833 PLEASUREC.
REC26905		807 CRUSADER	REC3852455		797 CRUSADER
REC26905		839 PLEASUREC.	REC3853796	RA057004	833 PLEASUREC.
REC27-14250	20129	796 CRUSADER	REC3853801	41074	799 CRUSADER
REC27-33395	96306	797 CRUSADER	REC3853801	41089	805 CRUSADER
REC27-33395	CHV-47-000	833 PLEASUREC.	REC3853801	R103004	837 PLEASUREC.
REC27-34213	3705042	835 PLEASUREC.	REC3853801		793 CHRIS-C.
REC27-34213	16.50-00074	791 CHRIS-C.	REC3853839	R130001	841 PLEASUREC.
REC27-344861	16.50-00162	794 CHRIS-C.			
REC27-34897	16.50-00078	790 CHRIS-C.			
REC27-34898	16.50-005756	791 CHRIS-C.			
REC27-99757	97498	797 CRUSADER			
REC3854001		807 CRUSADER			
REC3854002	7243200	807 CRUSADER			
REC3854003	7243110	807 CRUSADER			
REC3854161	3854161	807 CRUSADER			
REC3854190	987811	840 PLEASUREC.			
REC3854190	RA122001	840 PLEASUREC.			
REC3854190	RK122014	840 PLEASUREC.			
REC3854260		804 CRUSADER			
REC3854261	3854261	805 CRUSADER			
REC3854286	11418	846 WESTERB.			
REC3854286	11907	846 WESTERB.			
REC3854286	22212	800 CRUSADER			
REC3854286	33104	846 WESTERB.			
REC3854286	1003026	800 CRUSADER			
REC3854286	24880178	831 PERKINS			
REC3854286	132-0117	827 ONAN			
REC3854286	132-0317	827 ONAN			
REC3854286	NA900010	831 PERKINS			
REC3854286		790 CHRIS-C.			
REC3854286		820 KOHLER			
REC3854286		825 ONAN			
REC3854286		860 JABSCO			
REC3854286		846-847- WESTERB.			
REC3854286		808			
REC3854311	20223	805 CRUSADER			
REC3854331		804 CRUSADER			
REC3854548	38070	804 CRUSADER			
REC3854549	38071	805 CRUSADER			
REC3855194	47033	803 CRUSADER			
REC3855276	981650	800 CRUSADER			
REC3860171		841 PLEASUREC.			
REC3860703	40070	799 CRUSADER			
REC3860703	685011	816 INDMAR			
REC3860703	RA057023	834 PLEASUREC.			
REC3860703	RA057026	834 PLEASUREC.			
REC3860769		841 PLEASUREC.			
REC3861267	R117012	839 PLEASUREC.			
REC3887761		859 JABSCO			
REC391-5090	20117	805 CRUSADER			
REC391-5090	16.69-00039	793 CHRIS-C.			
REC391-5090	R114001	837 PLEASUREC.			
REC391-5090	R114004	837 PLEASUREC.			
REC391-5090Q1		794 CHRIS-C.			
REC391-5090Q1		806 CRUSADER			
REC391-5090Q1		838 PLEASUREC.			
REC3916854	3904445	812 CUMMINS			
REC3916854	3916854	812 CUMMINS			
REC392-6316	RA107001	838 PLEASUREC.			
REC392-6316		806 CRUSADER			
REC392-6324Q1		794 CHRIS-C.			
REC392-6324Q1		806 CRUSADER			
REC392-6324Q1		838 PLEASUREC.			
REC392-6325Q1		806 CRUSADER			
REC392-6330		838 PLEASUREC.			
REC392-9086T	41069	804 CRUSADER			
REC392-9086T		837 PLEASUREC.			
REC392-9766	41076	804 CRUSADER			
REC392-9766	45334	792 CHRIS-C.			
REC392-9766	RA108003	836 PLEASUREC.			
REC3922122	3922122	809 CUMMINS			
REC3922122	4019951	809 CUMMINS			
REC3922122	4020066	809 CUMMINS			
REC393-4988	3000121	804 CRUSADER			
REC393-4988		837 PLEASUREC.			
REC393-9459Q1	16.69-00052	793 CHRIS-C.			
REC3N4851	3N4851	786 CATERPIL.			
REC425-5421	4255421	787 CATERPIL.			
REC425-5421	425-5421	787 CATERPIL.			
REC4598-0001		860 JABSCO			
REC46-8M0113734	20318	799 CRUSADER			
REC46-8M0113734	7142520	799 CRUSADER			
REC46-8M0113734	RA057018	834 PLEASUREC.			
REC46-8M0113735	17670	799 CRUSADER			
REC46-8M0113735	30103	799 CRUSADER			
REC46-8M0113735	67859	799 CRUSADER			
REC46-8M0113735	811573	799 CRUSADER			
REC46-8M0113735	RA057019	833 PLEASUREC.			
REC47-43026Q02		860 JABSCO			
REC47-59362Q01		860 JABSCO			
REC47-809866T		859 JABSCO			
REC47-862232A2		860 JABSCO			
REC47-89984T4		860 JABSCO			
REC48080	33636	846 WESTERB.			
REC48080	37431				





REF	OEM	REF	OEM	REF	OEM
SHE17000K		SHEG2902X	196-8895	TEN00492	843 RENAULT C.
SHE18000K	4019403	SHEG2902X		TEN00493	843 RENAULT C.
SHE18000K	4933743	SHEG2903X	3349392	TEN00494	843 RENAULT C.
SHE18000K		SHEG2903X	4929178	TEN00495	843 RENAULT C.
SHE18000K		SHEG2903X	5260393	TEN01318T	130-4434 827 ONAN
SHE18000K		SHEG2903X		TEN01320T	811 CUMMINS 822 MASE
SHE18000K		SHEG2903X		TEN01801	851 SHERWOOD 843 RENAULT C.
SHE19354		SHEG30-2B	16.80-18346	TEN01802	790 CHRIS-C. 843 RENAULT C.
SHE22000K	3N8449	SHEG65	NA003335	TEN01803	831-832 PERKINS 843 RENAULT C.
SHE22000K		SHEG65		TEN01804	851 SHERWOOD 843 RENAULT C.
SHE22000K		SHEG702	132-0358	TEN02000T	825 ONAN 831 PERKINS
SHE23972		SHEG702	132-0459	TEN02020	825 ONAN 788 CATERPIL
SHE23973		SHEG702		TEN02021	849 SHERWOOD 6L2283 788 CATERPIL
SHE23973		SHEG8001	132-0275	TEN02021/1	819 KOHLER 116-7011 788 CATERPIL
SHE23973		SHEG8001		TEN02021/1T	852 SHERWOOD 788 CATERPIL
SHE23974		SHEG8002	132-0395	TEN02021T	826 ONAN 788 CATERPIL
SHE23975		SHEG8002	132-0430	TEN02021TP	826 ONAN 788 CATERPIL
SHE23975		SHEG8002		TEN02022	849 SHERWOOD 6L2282 788 CATERPIL
SHE23975		SHEG907P	344085	TEN02022T	819 KOHLER 788 CATERPIL
SHE23976		SHEG907P	344371	TEN02023	819 KOHLER 612289 788 CATERPIL
SHE23976		SHEG907P		TEN02023T	852 SHERWOOD 788 CATERPIL
SHE23976		SHEG910P	GM46936	TEN02023TP	819 KOHLER 788 CATERPIL
SHE23977		SHEG910P		TEN02024	852 SHERWOOD 6L2288 788 CATERPIL
SHE23977		SHEG9901		TEN02024T	850 SHERWOOD 788 CATERPIL
SHE23977		SHEG9903		TEN02024TP	850 SHERWOOD 788 CATERPIL
SHE23979		SHEGC1	3912962	TEN02025	810-811 CUMMINS 6L2284 788 CATERPIL
SHE23979		SHEGC1		TEN02026	851 SHERWOOD 6L2286 788 CATERPIL
SHE23979		SHEGC5	39127684	TEN02026T	810-811 CUMMINS 788 CATERPIL
SHE23979		SHEGC5		TEN02026TP	851 SHERWOOD 788 CATERPIL
SHE23980		SHEH5	NA005576	TEN02027	831-832 PERKINS 6L2280 788 CATERPIL
SHE23980		SHEH5		TEN02027T	851 SHERWOOD 788 CATERPIL
SHE23980		SHEK75B	132-0275	TEN02027TP	825 ONAN 6L2279 788 CATERPIL
SHE23981		SHEK75B	135-0278	TEN02028	825 ONAN 7E5076 788 CATERPIL
SHE23981		SHEK75B		TEN02028T	851 SHERWOOD 788 CATERPIL
SHE23981		SHEL10B	1320278	TEN02028TP	825 ONAN 788 CATERPIL
SHE24841		SHEL10B	132-0278	TEN02029	851 SHERWOOD 642281 788 CATERPIL
SHE24841		SHEM71	3010336	TEN02029bis	809 CUMMINS 6L3104 788 CATERPIL
SHE24842		SHEM71	3278137	TEN02029BIS/T	809 CUMMINS 788 CATERPIL
SHE24842		SHEM71	3907458	TEN02029TP	809 CUMMINS 6L2279G 788 CATERPIL
SHE25017		SHEM71	3912019	TEN02030	809 CUMMINS 827 ONAN
SHE25029		SHEM71		TEN02031	811 CUMMINS 827 ONAN
SHE25044		SHEM71		TEN02031TP	851 SHERWOOD 827 ONAN
SHE25044		SHEP1014	40050	TEN02032	799 CRUSADER 827 ONAN
SHE25045		SHEP1014	40050	TEN02033	834 PLEASUREC. 827 ONAN
SHE25105		SHEP1014	RA057031	TEN02040	799 CRUSADER 812 CUMMINS
SHE25106		SHEP1014		TEN02040	850 SHERWOOD 831 PERKINS
SHE25121		SHEP1016	854179001	TEN02041	810 CUMMINS 812 CUMMINS
SHE25121		SHEP1016	879312023	TEN02041	810 CUMMINS 831 PERKINS
SHE25122		SHEP1016		TEN02042	811 CUMMINS 812 CUMMINS
SHE25122		SHEP1016		TEN02042	849 SHERWOOD 831 PERKINS
SHE25123		SHEP1710C	4P-7168	TEN02043	786 CATERPIL 812 CUMMINS
SHE25123		SHEP1710C	7E-3268	TEN02043T	786 CATERPIL 812 CUMMINS
SHE25124		SHEP1710C		TEN02043T	787 CATERPIL 831 PERKINS
SHE25124		SHEP1710C		TEN02044	850 SHERWOOD 68241 812 CUMMINS
SHE25125		SHEP1716C	3919899	TEN02044T	810 CUMMINS 812 CUMMINS
SHE25125		SHEP1716C	3922590	TEN02044T	810 CUMMINS 831 PERKINS
SHE25126		SHEP1716C		TEN02044TP	811 CUMMINS 812 CUMMINS
SHE25126		SHEP1716C		TEN02053T	849 SHERWOOD 822 MASE
SHE25147		SHEP1722C	3912139	TEN02070T	809 CUMMINS 822 MASE
SHE25147		SHEP1722C	3922589	TEN02090	809 CUMMINS 843 RENAULT C.
SHE25148		SHEP1722C		TEN02090T	811 CUMMINS 843 RENAULT C.
SHE25195		SHEP1722C		TEN03500	849 SHERWOOD 844 VETUS
SHE25196		SHEP1727C	3897194	TEN03500	810 CUMMINS SET151 844 VETUS
SHE26000K	3972366	SHEP1727C		TEN03502	811 CUMMINS BP129 844 VETUS
SHE26000K		SHEP1727C		TEN03502	850 SHERWOOD SET153 844 VETUS
SHE26000K		SHEP1730C	3866493	TEN03503	810 CUMMINS 844 VETUS
SHE26000K		SHEP1730C	3897194	TEN03505	810 CUMMINS 845 VETUS
SHE27000K	3974456	SHEP1730C		TEN03505	811 CUMMINS BP1221 845 VETUS
SHE27000K		SHEP1730C		TEN03505	850 SHERWOOD SET0148 845 VETUS
SHE27000K		SHEP1732C	113-1109	TEN03506	786 CATERPIL BP1126 845 VETUS
SHE29000K		SHEP1732C	152-8392	TEN03506	786 CATERPIL SET0149 845 VETUS
SHE29000K		SHEP1732C	170-6116	TEN03507	786 CATERPIL BP1185 844 VETUS
SHE29000K		SHEP1732C		TEN03507	787 CATERPIL SET150 844 VETUS
SHE29000K		SHEP1732C		TEN03508	850 SHERWOOD BP1210 844 VETUS
SHE29000K		SHEP176X	7E.4115	TEN03508	786 CATERPIL SET0152 844 VETUS
SHE30000K		SHEP176X	9Y-1304	TEN03509	786 CATERPIL BP195 844 VETUS
SHE30000K		SHEP176X	FP-7E4115	TEN03510	786 CATERPIL ZINK15SC 844 VETUS
SHE30000K		SHEP176X		TEN03511	787 CATERPIL ZINK25SC 844 VETUS
SHE4257	20292	SHEP176X		TEN03512	850 SHERWOOD 844 VETUS
SHEE35	97179	SHEP2708X			851 SHERWOOD
SHEE35		SHEP2708X			810-811 CUMMINS
SHEG1010	132-0343	SHER10870G	11353		846 WESTERB.
SHEG1010	132-0347	SHER10870G			852 SHERWOOD
SHEG1010	132-0356				
SHEG1010	132-0413				
SHEG1010					
SHEG1012	132-0464	TEN00220	ZINK15C		845 VETUS
SHEG151		TEN00221	ZINK25C		845 VETUS
SHEG155		TEN00222			845 VETUS
SHEG21	RA57007	TEN00223	ZINK35C		845 VETUS
SHEG21		TEN00400SOLE/1	40030092		843 SOLE D.
SHEG2603X	3922589	TEN00400SOLE/2	50035092		843 SOLE D.
SHEG2603X	3967246	TEN00400SOLE/3	40045092		843 SOLE D.
SHEG2603X		TEN00400SOLE/4	40050092		843 SOLE D.
SHEG2603X		TEN00490			843 RENAULT C.
SHEG2603X		TEN00491			843 RENAULT C.

# OEM --> REF

OEM	REF	OEM	REF	OEM	REF			
BORG-W. 100-238-002	ALT023941	779	CATERPIL. 6L2016	CM6L2016	789	CRUSADER 20292	SHE4257	800
BORG-W. 1004-650-001	ALTD4-101	779	CATERPIL. 6L2280	CME1	789	CRUSADER 20300	CEF500120T	800
BORG-W. 1004-650-002	ALTD4-102	779	CATERPIL. 6L2283	CM6L2283	789	CRUSADER 20300	REC10615K	800
BORG-W. 1004-650-006	REC855694	779	CATERPIL. 6L2284	CME8D	789	CRUSADER 20300	SHE10615K	800
BORG-W. 1004-650-007	ALTD4-107	779	CATERPIL. 6L2285	CME-8	789	CRUSADER 20309	SHE10927	800
BORG-W. 1004-650-008	ALTD4-108	779	CATERPIL. 6L2288	CM6L2288	789	CRUSADER 20310	CEF500120T	800
BORG-W. 2001-238-001	ALT340940	779	CHRIS-C. 16.50-00078	REC27-34897	790	CRUSADER 20310	REC10615K	800
BORG-W. 1308-410-001	A/P2279	780	CHRIS-C. 16.50-00250	REC17030	790	CRUSADER 20310	SHE10615K	800
BORG-W. A4867HA	A/P2277	780	CHRIS-C. 16.50-00259	REC17046	790	CRUSADER 22212	CEF500103T	800
CATERPIL. 1R-0658	REC21707134	785	CHRIS-C. 16.80-18346	SHEG30-2B	790	CRUSADER 22212	REC3854286	800
CATERPIL. 1R-0714	REC847741	785	CHRIS-C. 1650-056022	BACC47-1650-06022	790	CRUSADER 40057	SHE12859	800
CATERPIL. 1W6586	REC300-0539	785	CHRIS-C. 1650-05944	OSC0959	790	CRUSADER 727103	REC10077K	800
CATERPIL. 1W6586	REC8N2250	785	CHRIS-C. 16.50-00074	REC27-34213	791	CRUSADER 981650	REC3855276	800
CATERPIL. 8N2250	REC300-0539	785	CHRIS-C. 16.50-005756	REC27-34898	791	CRUSADER 982063	REC62092T	800
CATERPIL. 8N2250	REC8N2250	785	CHRIS-C. 16.80-90047	SHE10077K	791	CRUSADER 1003026	CEF500103T	800
CATERPIL. 113-1109	SHEP1732C	786	CHRIS-C. 16.80-90049	SHE09959K	791	CRUSADER 1003026	REC3854286	800
CATERPIL. 152-8392	SHEP1732C	786	CHRIS-C. 16.80-90131	SHE10615K	791	CRUSADER 1003026	SHE09959K	800
CATERPIL. 170-6116	SHEP1732C	786	CHRIS-C. 16.80-90166	SHE09959K	791	CRUSADER 1003062	CEF500103T	800
CATERPIL. 3N4851	REC3N4851	786	CHRIS-C. 16.81-08746	REC35-06003	791	CRUSADER R061017	CEF500120T	800
CATERPIL. 4P-7168	SHEP1710C	786	CHRIS-C. 1R-16.81-06536	REC35-06007	791	CRUSADER R061017	SHE10615K	800
CATERPIL. 5N9357	REC5N9357	786	CHRIS-C. 45334	REC392-9766	792	CRUSADER 91606	REC982230	801
CATERPIL. 7C3613	REC7C3613	786	CHRIS-C. 45334	REC823426A1	792	CRUSADER 96358	REC76270T	801
CATERPIL. 7C3614	REC7C3614	786	CHRIS-C. 16.69-00148	REC982209	792	CRUSADER 97361	REC97361	801
CATERPIL. 7E.4115	SHEP176X	786	CHRIS-C. 18-5399	REC835702	792	CRUSADER 97895	REC8M0091470	801
CATERPIL. 9Y-1304	SHEP176X	786	CHRIS-C. 41057	REC33662	793	CRUSADER 98041	REC35-8M0061975	801
CATERPIL. FP-7E4115	SHEP176X	786	CHRIS-C. 1869704	REC64851	793	CRUSADER 201104	REC35-06003	801
CATERPIL. 4255421	REC425-5421	787	CHRIS-C. 16.69-00039	REC391-5090	793	CRUSADER 201104	REC3850559	801
CATERPIL. 123-0471	REC62904X	787	CHRIS-C. 16.69-00040	REC8M6001217	793	CRUSADER 9002514	REC35-06007	801
CATERPIL. 147-7850	REC63001X	787	CHRIS-C. 16.69-00042	REC841243	793	CRUSADER 45334	REC823426A1	802
CATERPIL. 197-1328	REC62904X	787	CHRIS-C. 16.69-00049	REC34235T	793	CRUSADER 33628	REC805298A1	803
CATERPIL. 212-7264	REC63001X	787	CHRIS-C. 16.69-00050	REC33662	793	CRUSADER 47002	REC3850397	803
CATERPIL. 322-8594	REC63001X	787	CHRIS-C. 16.69-00051	REC58217	793	CRUSADER 47032	REC8M0125617	803
CATERPIL. 425-5421	REC425-5421	787	CHRIS-C. 16.69-00052	REC393-9459Q1	793	CRUSADER 47033	REC3855194	803
CATERPIL. 612289	TEN02023	788	CHRIS-C. 16.69-00100	REC12532	793	CRUSADER 97214	REC85785A2	803
CATERPIL. 642281	TEN02029	788	CHRIS-C. 16.69-00149	REC89825302	793	CRUSADER 97595	REC85785A2	803
CATERPIL. 1095324	CEF500182G	788	CHRIS-C. F16900165	REC12532	793	CRUSADER 700425	REC8M0068784	803
CATERPIL. 1095324	REC18000K	788	CHRIS-C. 16.50-00162	REC27-344861	794	CRUSADER 700427	REC97258A1	803
CATERPIL. 1095327	CEF500182G	788	CHRIS-C. 37068	REC1463-9382	795	CRUSADER 12528	REC33708	804
CATERPIL. 1095327	REC18000K	788	CHRIS-C. 51080	REC1463-9382	795	CRUSADER 20222	REC822209	804
CATERPIL. 1230492	CEF500182G	788	CHRIS-C. 16.61-0042	REC50-99417A2	795	CRUSADER 38070	REC3854548	804
CATERPIL. 1230492	REC18000K	788	CHRIS-C. 16.61-0043	REC50-99417A2	795	CRUSADER 41069	REC392-9086T	804
CATERPIL. 1237985	CEF500182G	788	CRUSADER 30266	REC17040	795	CRUSADER 41076	REC392-9766	804
CATERPIL. 1237985	REC18000K	788	CRUSADER 31136	REC17042	795	CRUSADER 3000121	REC393-4988	804
CATERPIL. 7E0321	CEF500164T	788	CRUSADER 31137	REC17048	795	CRUSADER 16.69-00100	REC12532	804
CATERPIL. 7E3022	JAB18786-0001	788	CRUSADER 33408	REC17010	795	CRUSADER F16900165	REC12532	804
CATERPIL. 7E0321	REC17000K	788	CRUSADER 7057500	REC17030	795	CRUSADER 12526	REC33706	805
CATERPIL. 7E0321	SHE17000K	788	CRUSADER 20129	REC27-14250	796	CRUSADER 12530	REC8M6001217	805
CATERPIL. 7E5076	TEN02028	788	CRUSADER 33393	REC17310	796	CRUSADER 12531	REC841243	805
CATERPIL. 116-7011	TEN02021/1	788	CRUSADER 91351	REC17930	796	CRUSADER 20117	REC391-5090	805
CATERPIL. 1L4774	CEF500105T	788	CRUSADER 96120	HOT20925	796	CRUSADER 20223	REC3854311	805
CATERPIL. 1L4774	JOH09-1029B	788	CRUSADER 96121	HOT20926	796	CRUSADER 20223	REC89825302	805
CATERPIL. 1L4774	REC836-0001	788	CRUSADER 97114	HOT20929	796	CRUSADER 38071	REC3854549	805
CATERPIL. 1W5664	CEF500164T	788	CRUSADER 97115	HOT20933	796	CRUSADER 41057	REC33662	805
CATERPIL. 1W5664	REC17000K	788	CRUSADER 97686	REC17920	796	CRUSADER 41058	REC8M6001219	805
CATERPIL. 1W5664	SHE17000K	788	CRUSADER 97752	HOT20925	796	CRUSADER 41059	REC834975	805
CATERPIL. 3N1906	CEF500106GT	788	CRUSADER 97753	HOT20926	796	CRUSADER 41074	REC3853801	805
CATERPIL. 3N1906	JOH09-1028B	788	CRUSADER 97992	HOT20929	796	CRUSADER 41089	REC3853801	805
CATERPIL. 3N1906	REC3841697	788	CRUSADER 97993	HOT20933	796	CRUSADER 705787	REC33662	805
CATERPIL. 3N4859	CEF500152	788	CRUSADER 96306	REC27-33395	797	CRUSADER 1003318	REC841243	805
CATERPIL. 3N4859	JAB17370-0001	788	CRUSADER 97498	REC27-99757	797	CRUSADER 3000122	REC65864	805
CATERPIL. 3N5895	CEF500177GT	788	CRUSADER 98125	HOT20982	797	CRUSADER 3000124	REC58033	805
CATERPIL. 3N5895	JAB17018-0001	788	CRUSADER 98126	HOT20938	797	CRUSADER 3854261	REC3854261	805
CATERPIL. 3N5895	REC3593573	788	CRUSADER 98128	HOT30984	797	CRUSADER 37061	REC17177A1	806
CATERPIL. 3N8449	CEF500179GX	788	CRUSADER 98243	REC98243	797	CRUSADER RA107039E	REC805222A1	806
CATERPIL. 3N8449	SHE22000K	788	CRUSADER 96560	HOT20934	798	CRUSADER 37068	REC1463-9382	807
CATERPIL. 4L8470	CEF500145T	788	CRUSADER 96562	HOT26562-MK	798	CRUSADER 51080	REC1463-9382	807
CATERPIL. 4L8470	JOH09-814B	788	CRUSADER 96562	REC96562	798	CRUSADER 3854161	REC3854161	807
CATERPIL. 4L8470	REC875697	788	CRUSADER 97169	HOT20916	798	CRUSADER 7243110	REC3854003	807
CATERPIL. 5N9360	CEF500135	788	CRUSADER 97386	HOT20918	798	CRUSADER 7243200	REC3854002	807
CATERPIL. 5N9360	JOH09-819B	788	CRUSADER 97387	OSC7387	798	CRUSADER	REC26901	807
CATERPIL. 5N9360	REC21730344	788	CRUSADER 97624	OSC7624	798	CRUSADER	REC26904	807
CATERPIL. 6L2016	TEN02022	788	CRUSADER 97772	HOT20927	798	CRUSADER	REC26905	807
CATERPIL. 6L2279	TEN02027TP	788	CRUSADER 97924	HOT20928	798	CRUSADER	REC26905	807
CATERPIL. 6L2279G	TEN02029TP	788	CRUSADER 98068	HOT20934	798	CRUSADER	REC300-00879	807
CATERPIL. 6L2280	TEN02027	788	CRUSADER 17670	REC46-8M0113735	799	CRUSADER	REC3854001	807
CATERPIL. 6L2282	TEN02021TP	788	CRUSADER 20318	REC46-8M0113734	799	CRUSADER 42090	REC50-97499A2	808
CATERPIL. 6L2283	TEN02021	788	CRUSADER 30103	REC46-8M0113735	799	CRUSADER 42091	REC50-808011A05	808
CATERPIL. 6L2284	TEN02025	788	CRUSADER 40050	RECP1014	799	CRUSADER 1109482	REC50-99418A2	808
CATERPIL. 6L2286	TEN02026	788	CRUSADER 40050	SHEP1014	799	CRUSADER 1109484	REC50-97499A2	808
CATERPIL. 6L2288	TEN02024	788	CRUSADER 40070	REC3860703	799	CRUSADER 1109485	REC50-808011A05	808
CATERPIL. 6L3104	TEN02029bis	788	CRUSADER 67859	REC46-8M0113735	799	CRUSADER 9000888	REC50-808011A05	808
CATERPIL. 7C3286	CEF500114T	788	CRUSADER 97179	SHEE35	799	CRUSADER 19010615	REC50-808011A05	808
CATERPIL. 7C3286	JAB17937-0001-P	788	CRUSADER 811573	REC46-8M0113735	799	CRUSADER 19010617	REC50-97499A2	808
CATERPIL. 796351	REC8HC2023K	789	CRUSADER 7142520	REC46-8M0113734	799	CRUSADER RA122008	REC50-97499A2	808
CATERPIL. 128000-5720	REC128000-5720	789	CRUSADER RA057031	RECP1014	799	CRUSADER RA122009	REC50-808011A05	808
CATERPIL. 163-3361	REC21323043	789	CRUSADER RA057031	SHEP1014	799	CRUSADER RA122015	REC50-863007A1	808



OEM	REF	OEM	REF	OEM	REF						
CUMMINS	3010336	DJC004	809	DETROIT D.	5193553	CEF500105T	814	NANNI D.	434013	REC3586496	823
CUMMINS	3010336	DJC0820	809	DETROIT D.	5193553	JOH09-1029B	814	NANNI D.	434014	CEF500101X	823
CUMMINS	3010336	SHEM71	809	DETROIT D.	5193553	REC836-0001	814	NANNI D.	434014	JOH09-810B	823
CUMMINS	3278137	DJC004	809	DETROIT D.	5193602	CEF500106GT	814	NANNI D.	434014	REC653-0001	823
CUMMINS	3278137	DJC0820	809	DETROIT D.	5193602	JOH09-1028B	814	NANNI D.	48200932	REC873770	823
CUMMINS	3278137	SHEM71	809	DETROIT D.	5193602	REC3841697	814	NANNI D.	50.06506.0089	CEF500135	823
CUMMINS	3349392	SHEG2903X	809	DETROIT D.	5196168	CEF500145T	814	NANNI D.	50.06506.0089	JOH09-814B	823
CUMMINS	3897194	DJC1730	806	DETROIT D.	5196168	JOH09-814B	814	NANNI D.	50.06506.0089	REC21730344	823
CUMMINS	3907458	DJC0820	809	DETROIT D.	5196168	REC875697	814	NANNI D.	50.06506.0091	CEF500106GT	823
CUMMINS	3907458	SHEM71	809	DETROIT D.	5196629	CEF500106GT	814	NANNI D.	50.06506.0091	JOH09-1028B	823
CUMMINS	3912019	DJC0820	809	DETROIT D.	5196629	JOH09-1028B	814	NANNI D.	50.06506.0091	REC3841697	823
CUMMINS	3912019	SHEM71	809	DETROIT D.	5196629	REC3841697	814	NANNI D.	51.06506.0103	JOH09-821B	823
CUMMINS	3912139	DJC0819	809	DETROIT D.	5199148	CEF500106GT	814	NANNI D.	51.06506.0106	JOH09-820B	823
CUMMINS	3912139	RECP1722C	809	DETROIT D.	5199148	JOH09-1028B	814	NANNI D.		CEF500114T	823
CUMMINS	3912139	SHEP1722C	809	DETROIT D.	5199148	REC3841697	814	NANNI D.		CEF500146X	823
CUMMINS	3922122	REC3922122	809	DETROIT D.	8924838	CEF500135	814	NANNI D.		JAB17937-0001-P	823
CUMMINS	3922589	DJC0819	809	DETROIT D.	8924838	JOH09-819B	814	NANNI D.		JOH09-1027B	823
CUMMINS	3922589	RECP1722C	809	DETROIT D.	8927570	CEF500152	814	NANNI D.		REC17937-0001	823
CUMMINS	3922589	SHEG2603X	809	DETROIT D.	8927570	JAB17370-0001	814	NANNI D.		REC21213660	823
CUMMINS	3922589	SHEP1722C	809	DETROIT D.	8927570	REC17370-0001	814	NANNI D.		RM841812	823
CUMMINS	3964989	RECP1722C	809	DETROIT D.	23502086	CEF500153	814	ONAN	1220602	REC1220602	824
CUMMINS	3967246	SHEG2603X	809	DETROIT D.	23502086	JAB18786-0001	814	ONAN	1491754	REC1491754	824
CUMMINS	4019951	REC3922122	809	FISHER P.	20291	REC10-24571-01	814	ONAN	1491758	REC1491758	824
CUMMINS	4020066	REC3922122	809	FISHER P.	060-068-0-0-B	REC10-35127-3	814	ONAN	1492250	REC1492250	824
CUMMINS	4929178	SHEG2903X	809	FISHER P.	10-24571-01	REC10-24571-01	814	ONAN	1855835	REC1855835	824
CUMMINS	5260393	SHEG2903X	809	FISHER P.	10-35127-3	REC10-35127-3	814	ONAN	149-2106	REC149-2106	824
CUMMINS	3866493	DJC1730	810	FISHER P.	FP1-000410	REC10-35127-3	814	ONAN	1492251 II	REC1492251II	824
CUMMINS	3866493	SHEP1730C	810	FISHER P.	IC36.03.01.007H	REC10-35127-3	814	ONAN	185-5835	REC1855835	824
CUMMINS	3897194	SHEP1727C	810	HURT	879194241	REC016940	815	ONAN	1220810	REC1220810	825
CUMMINS	3897194	SHEP1730C	810	HURT	8791014241	REC016940	815	ONAN	1320278	SHEL10B	825
CUMMINS	3919899	RECP1716C	810	HURT	35-813405	REC016940	815	ONAN	122-0550	REC1220550	825
CUMMINS	3919899	SHEP1716C	810	HURT	35-813405A1	REC016940	815	ONAN	122-0810	REC1220810	825
CUMMINS	3922590	RECP1716C	810	HURT	35-815419	REC016940	815	ONAN	122.0716.712	REC1220716712	825
CUMMINS	3922590	SHEP1716C	810	HURT	F19608751	REC016940	815	ONAN	132-0275	SHEK75B	825
CUMMINS	854179001	SHEP1016	810	HURT	FFF001138	REC016940	815	ONAN	132-0278	SHEL10B	825
CUMMINS	879312023	SHEP1016	810	INDMAR	0994-000	HOT20997	815	ONAN	132-0358	SHEG702	825
CUMMINS	3349198	CEF500167	811	INDMAR	53-2009	HOT20907	815	ONAN	132-0459	SHEG702	825
CUMMINS	3349198	REC15000K	811	INDMAR	53-2018	HOT20907	815	ONAN	135-0278	SHEK75B	825
CUMMINS	3349198	SHE15000K	811	INDMAR	53-2800	HOT20998	815	ONAN	185-2133	REC185-2133	825
CUMMINS	3802444	CEF500164T	811	INDMAR	685011	REC3860703	816	ONAN	187.0014	REC1870014	825
CUMMINS	3802444	REC17000K	811	INDMAR	751007	REC8M6001219	816	ONAN	132-0343	RECG1010	826
CUMMINS	3802444	SHE17000K	811	INDMAR	53-2027-T	HGE2027	816	ONAN	132-0343	SHEL1010	826
CUMMINS	3897337	CEF500164T	811	INDMAR	573001	REC50-97499A2	817	ONAN	132-0347	RECG1010	826
CUMMINS	3897337	REC17000K	811	INDMAR	575010	REC575010	817	ONAN	132-0347	SHEG1010	826
CUMMINS	3897337	SHE17000K	811	INDMAR	575011	REC575011	817	ONAN	132-0356	RECG1010	826
CUMMINS	3908220	CEF500120T	811	INDMAR	755017	REC33662	817	ONAN	132-0356	SHEG1010	826
CUMMINS	3908220	REC10615K	811	KOHLER	229678	REC229678	818	ONAN	132-0358	RECG702	826
CUMMINS	3908220	SHE10615K	811	KOHLER	229826	REC09000K	819	ONAN	132-0379	RECG702	826
CUMMINS	3916720	CEF500167	811	KOHLER	344085	REC344085	819	ONAN	132-0395	RECG8002	826
CUMMINS	3916720	REC15000K	811	KOHLER	344085	SHEG907P	819	ONAN	132-0395	SHEG8002	826
CUMMINS	3916720	SHE15000K	811	KOHLER	344371	REC344085	819	ONAN	132-0413	RECG1010	826
CUMMINS	3916852	CEF500164T	811	KOHLER	344371	SHEG907P	819	ONAN	132-0413	SHEG1010	826
CUMMINS	3916852	REC17000K	811	KOHLER	359978	REC08000K	819	ONAN	132-0415	RECG8002	826
CUMMINS	3916852	SHE17000K	811	KOHLER	132-0275	SHEG8001	819	ONAN	132-0430	RECG8002	826
CUMMINS	3925236	CEF500164T	811	KOHLER	GM46936	RECGM46936	819	ONAN	132-0430	SHEG8002	826
CUMMINS	3925236	REC17000K	811	KOHLER	GM46936	SHEG910P	819	ONAN	132-0459	RECG702	826
CUMMINS	3925236	SHE17000K	811	KOHLER	GM58527	REC29350-1001	819	ONAN	132-0464	SHEG1012	826
CUMMINS	3972366	CEF500183G	811	KOHLER	229826	CEF500165	820	ONAN	A029U129	RECG1010	826
CUMMINS	3974456	CEF500181G	811	KOHLER	229826	SHE09000K	820	ONAN	A032V747	RECG1012	826
CUMMINS	3974456	REC27000K	811	KOHLER	229955	CEF500129	820	ONAN	G1010	RECG1010	826
CUMMINS	4019403	CEF500182G	811	KOHLER	229955	REC22779-0001	820	ONAN	G1010-1	RECG1010	826
CUMMINS	4019403	REC18000K	811	KOHLER	250872	CEF500129	820	ONAN	G1012	RECG1012	826
CUMMINS	4019403	SHE18000K	811	KOHLER	250872	REC22779-0001	820	ONAN	G701	RECG702	826
CUMMINS	4933743	CEF500182G	811	KOHLER	252882	REC21213660	820	ONAN	G702	RECG702	826
CUMMINS	4933743	REC18000K	811	KOHLER	260085	CME0	820	ONAN	G8002	RECG8002	826
CUMMINS	4933743	SHE18000K	811	KOHLER	267928	CME0	820	ONAN	08-21-1201	CEF500107T	827
CUMMINS	68241	TEN02044	812	KOHLER	359978	CEF500190G	820	ONAN	08-21-1201	JAB12104-0001	827
CUMMINS	882571	REC882571	812	KOHLER	359978	SHE08000K	820	ONAN	08-21-1201	JOH09-1027B	827
CUMMINS	3904445	REC3916854	812	MAN	50.06506.0089	CEF500145T	821	ONAN	08-21-1201	REC21213660	827
CUMMINS	3916854	REC3916854	812	MAN	50.06506.0089	JOH09-814B	821	ONAN	130-4434	TEN01318T	827
CUMMINS	3604654RX	REC3604654RX	812	MAN	50.06506.0089	REC875697	821	ONAN	131-0050	CEF500107T	827
CUMMINS	8M0084523	REC882571	812	MAN	50.06506.0091	CEF500106GT	821	ONAN	131-0050	JAB12104-0001	827
DETROIT D.	18780	REC8927296	813	MAN	50.06506.0091	JOH09-1028B	821	ONAN	131-0050	JOH09-1027B	827
DETROIT D.	5145576	REC5145578	813	MAN	50.06506.0091	REC3841697	821	ONAN	131-0050	REC21213660	827
DETROIT D.	5145577	REC5145578	813	MAN	51.06505.0103	CEF500162G	821	ONAN	132-0117	CEF500103T	827
DETROIT D.	5145578	REC5145578	813	MAN	51.06505.0103	JOH09-821B	821	ONAN	132-0117	REC3854286	827
DETROIT D.	5197221	REC5197221	813	MAN	51.06505.0106	CEF500186T	821	ONAN	132-0117	SHE09959K	827
DETROIT D.	8923363	REC8923363	813	MAN	51.06505.0106	JOH09-820B	821	ONAN	132-0162	CEF500107T	827
DETROIT D.	8927296	REC8927296	813	MAN	51.06505.0127	JOH09-842B	821	ONAN	132-0162	JAB12104-0001	827
DETROIT D.	23502086	REC18786-0001	813	MAN	65.00600.0016	REC22040-0701S	821	ONAN	132-0162	JOH09-1027B	827
DETROIT D.	23507475	REC8923363	813	MASE	20291	REC10-24571-01	822	ONAN	132-0162	REC21213660	827
DETROIT D.	23507476	REC8923363	813	MASE	20639	REC10-24570-01	822	ONAN	132-0292	CEF500120T	827
DETROIT D.	23507477	REC8923363	813	MASE	10-24570-01	REC10-24570-01	822	ONAN	132-0292	REC10615K	827
DETROIT D.	23507973	REC8923363	813	MASE	10-24571-01	REC10-24571-01	822	ONAN	132-0292	SHE10615K	827
DETROIT D.	23525200	REC23535447	813	NANNI D.	434013	CEF500121GX	823	ONAN	132-0317	CEF500103T	827
DETROIT D.	23535477	REC23535447	813	NANNI D.	434013	JOH09-808B	823	ONAN	132-0317	REC3854286	827

OEM	REF		OEM	REF		OEM	REF	
ONAN	132-0317	827	PLEASUREC. RP026002E	REC97361	834	VETUS	SET153	TEN03502
ONAN	132-0348	827	PLEASUREC. RP061015	SHE09959K	834	VETUS	STM8061	CEF500101X
ONAN	132-0348	827	PLEASUREC. RP061017	SHE10615K	834	VETUS	STM8061	JOH09-810B
ONAN	132-0348	827	PLEASUREC. 40050	REC62092T	835	VETUS	STM8061	REC653-0001
ONAN	132-0349	827	PLEASUREC. 3705042	REC27-34213	835	VETUS	ZINK15SC	TEN03510
ONAN	132-0349	827	PLEASUREC. R077001	REC35-06007	835	VETUS	ZINK25SC	TEN03511
ONAN	132-0349	827	PLEASUREC. R077002	REC35-06003	835	VETUS	BP1126	TEN03506
ONAN	132-0375	827	PLEASUREC. RN0116	REC1396-4656	835	VETUS	BP1221	TEN03505
ONAN	132-0375	827	PLEASUREC. RN0116-2	REC1396-4656	835	VETUS	SET0148	TEN03505
ONAN	132-0375	827	PLEASUREC. RN0118	REC1396-5238	835	VETUS	SET0149	TEN03506
ONAN	132-0407	827	PLEASUREC. RN0120	REC1396-4148	835	VETUS	ZINK15C	TEN00220
ONAN	132-0407	827	PLEASUREC. R020027	REC806612T	836	VETUS	ZINK25C	TEN00221
ONAN	132-0407	827	PLEASUREC. R020035A	REC892615002	836	VETUS	ZINK35C	TEN00223
ONAN	132-0415	827	PLEASUREC. R084003	REC3843751	836	WESTERB.	33486	REC50-97499A2
ONAN	132-0415	827	PLEASUREC. RA108002	REC835702	836	WESTERB.	36918	REC36918
ONAN	132-0415	827	PLEASUREC. RA108003	REC392-9766	836	WESTERB.	11353	SHER10870G
ONAN	132-0464	827	PLEASUREC. RN0116	REC1396-4148	836	WESTERB.	11418	CEF500103T
ONAN	132-0498	827	PLEASUREC. RN0116-2	REC1396-4148	836	WESTERB.	11418	REC3854286
ONAN	132-0498	827	PLEASUREC. R0200001	REC8M0068784	836	WESTERB.	11418	SHE09959K
ONAN	132-0498	827	PLEASUREC. R08001	REC982209	837	WESTERB.	11764	CEF500166
ONAN	132-0859	827	PLEASUREC. R103001	REC89825302	837	WESTERB.	11764	REC10077K
ONAN	132B59	827	PLEASUREC. R103003	REC834975	837	WESTERB.	11764	SHE10077K
ONAN	G1009	827	PLEASUREC. R103004	REC3853801	837	WESTERB.	11907	CEF500103T
ONAN	882481	828	PLEASUREC. R103011	REC898253013	837	WESTERB.	11907	REC3854286
ONAN	889903	828	PLEASUREC. R114001	REC391-5090	837	WESTERB.	11907	SHE09959K
ONAN	879194371	828	PLEASUREC. R114002	REC8M6001219	837	WESTERB.	13930	CEF500120T
ONAN	185-2166	828	PLEASUREC. R114004	REC391-5090	837	WESTERB.	13930	REC10615K
ONAN	A026K278	828	PLEASUREC. R115001	REC8M6001217	837	WESTERB.	13930	SHE10615K
PERKINS	135616660	828	PLEASUREC. R115002	REC33662	837	WESTERB.	30594	ARC86050
PERKINS	89058	829	PLEASUREC. RA108009	REC898253T22	837	WESTERB.	33100	CEF500166
PERKINS	2654347	829	PLEASUREC. RA107001	REC392-6316	838	WESTERB.	33100	REC10077K
PERKINS	2654407	829	PLEASUREC. RA107039E	REC805222A1	838	WESTERB.	33100	SHE10077K
PERKINS	135616660	829	PLEASUREC. R117001	REC1463-9382	839	WESTERB.	33104	CEF500103T
PERKINS	135616660	829	PLEASUREC. R117012	REC3861267	839	WESTERB.	33104	REC3854286
PERKINS	3776F024	829	PLEASUREC. 987811	REC3854190	840	WESTERB.	33104	SHE09959K
PERKINS	2656017	830	PLEASUREC. 9000888	REC50-97499A2	840	WESTERB.	33636	REC48080
PERKINS	M20	830	PLEASUREC. RA097002	REC69729	840	WESTERB.	37431	CEF500101X
PERKINS	460024	831	PLEASUREC. RA097003	REC69729	840	WESTERB.	37431	JOH09-810B
PERKINS	460024	831	PLEASUREC. RA097006	REC69729	840	WESTERB.	37431	REC48080
PERKINS	460024	831	PLEASUREC. RA122001	REC3854190	840	WESTERB.	37431	REC653-0001
PERKINS	460027	831	PLEASUREC. RA122008	REC50-97499A2	840	WESTERB.	42026	REC10-24569-01
PERKINS	460027	831	PLEASUREC. RA122009	REC50-808011A05	840	WESTERB.	48080	CEF500101X
PERKINS	460027	831	PLEASUREC. RK122014	REC3854190	840	WESTERB.	48080	JOH09-810B
PERKINS	460027	831	PLEASUREC. R017066	REC90301-ZW1-003	841	WESTERB.	48080	REC48080
PERKINS	460027	831	PLEASUREC. R085035	REC32-86036	841	WESTERB.	48080	REC653-0001
PERKINS	460038	831	PLEASUREC. R094020A	REC23-99291	841	WESTERB.	55624	REC10-24569-01
PERKINS	460038	831	PLEASUREC. R096081	REC897367	841	WESTERB.	302648	REC908
PERKINS	460038	831	PLEASUREC. R096116	REC12-835467Q01	841	WESTERB.	302837	REC908
PERKINS	24880031	831	PLEASUREC. R096117	REC90508-ZW1-003	841	WESTERB.	302875	CEF500165
PERKINS	24880031	831	PLEASUREC. R130001	REC3853839	841	WESTERB.	302875	REC09000K
PERKINS	24880031	831	PLEASUREC. RA097007	REC575010	841	WESTERB.	302875	SHE09000K
PERKINS	24880178	831	PLEASUREC. RA097007	REC575011	841	WESTERB.	10-24569-01	REC10-24569-01
PERKINS	24880178	831	RENAULT C. 48300006	CEF500128	842	WESTERB.	G903	REC908
PERKINS	24880178	831	RENAULT C. 48300008	CEF500122T	842	WESTERB.	G908	REC908
PERKINS	24880190	831	RENAULT C. 48300037	CEF500127	842	WESTERB.	11885	CME0
PERKINS	24880190	831	RENAULT C. RC320D	CEF500106GT	842			
PERKINS	24880190	831	RENAULT C. RC320D	JOH09-1028B	842			
PERKINS	24880194	831	RENAULT C. RC320D	REC3841697	842			
PERKINS	24880194	831	SOLE D. 40030092	TEN00400SOLE/1	843			
PERKINS	24880194	831	SOLE D. 40045092	TEN00400SOLE/3	843			
PERKINS	24880272	831	SOLE D. 40050092	TEN00400SOLE/4	843			
PERKINS	24880272	831	SOLE D. 50035092	TEN00400SOLE/2	843			
PERKINS	24880272	831	SOLE D. 312.11.008	CEF500123X	843			
PERKINS	NA900010	831	SOLE D. 321.11.008	CEF500131X	843			
PERKINS	NA900010	831	SOLE D. 347.11.008	CEF500106GT	843			
PERKINS	NA900010	831	SOLE D. 347.11.008	JOH09-1028B	843			
PERKINS	NA900012	831	SOLE D. 347.11.008	REC3841697	843			
PERKINS	NA900012	831	SOLE D. 351.11.008	CEF500107T	843			
PERKINS	185086600	832	SOLE D. 351.11.008	JOH09-1027B	843			
PERKINS	185086610	832	SOLE D. 351.11.008	REC21213660	843			
PERKINS	185086620	832	VETUS	BP1185	844			
PLEASUREC.	RM0032	832	VETUS	BP1210	844			
PLEASUREC.	6269577	832	VETUS	BP129	844			
PLEASUREC.	CHV-47-000	833	VETUS	BP195	844			
PLEASUREC.	R028001	833	VETUS	BP195E	844			
PLEASUREC.	R029001	833	VETUS	IMPO0101	844			
PLEASUREC.	RA057004	833	VETUS	IMPO0101	844			
PLEASUREC.	RA057019	833	VETUS	IMPO0201	844			
PLEASUREC.	RM0007	833	VETUS	IMPO0201	844			
PLEASUREC.	40050	834	VETUS	IMPO0301	844			
PLEASUREC.	40050	834	VETUS	IMPO0301	844			
PLEASUREC.	R026002E	834	VETUS	IMPO0301	844			
PLEASUREC.	RA057018	834	VETUS	IMPO0701	844			
PLEASUREC.	RA057023	834	VETUS	SET0152	844			
PLEASUREC.	RA057026	834	VETUS	SET150	844			
PLEASUREC.	RA57007	834	VETUS	SET151	844			



**POLÍTICA DE GARANTIA Y DEVOLUCIÓN**  
**WARRANTY AND RETURN POLICY**  
**POLITICA DI GARANZIE E REGOLE PER I RESI MERCE**  
**POLITIQUE DE GARANTIE ET RETOUR DE PIÈCES**

## POLÍTICA DE GARANTÍAS RECMAR

Todos los productos comercializados por **Recambios Marinos S.L.U.** deben ser instalados y utilizados por personal competente bajo su exclusiva responsabilidad. **Recambios Marinos S.L.U.** no se responsabiliza de las consecuencias producidas por una instalación defectuosa o inapropiada de ningún artículo que no incluya soluciones de instalación.

El instalador será el responsable de verificar la correcta aplicación de las recomendaciones del fabricante en cuanto a compatibilidades de uso.

Los artículos comercializados por **Recambios Marinos S.L.U.** están amparados por la garantía legal de conformidad, conforme a las condiciones expuestas en el real decreto legislativo 1/2007 de 16 de Noviembre, aprobación del texto refundido de la ley general para la defensa de los consumidores y usuarios.

**Recambios Marinos S.L.U.** distribuye los artículos presentes en sus catálogos únicamente a profesionales, nunca a particulares o cliente final, el importe de la instalación jamás estará incluido en el precio por lo que no será responsable de ésta.

Los artículos comercializados por **Recambios Marinos S.L.U.** disponen de una garantía limitada por defectos de fabricación, los periodos pueden variar entre los 2 años y los 3 meses dependiendo del producto, aplicación y tipo de embarcación (lista 7ª/ 6ª/ 5ª), descartando los artículos considerados como

consumibles: bombillas, productos eléctricos, baterías y otros que carecen de periodo alguno, si necesita conocer el plazo exacto del producto contacte con el departamento comercial.

Por daños ocasionados en el transporte, se aplicará lo indicado en el artículo 366 de Código de Comercio, que dice : "Dentro de las veinticuatro horas siguientes al recibo de las mercancías, podrá hacerse reclamación contra la empresa de transporte asignada. Transcurridos los términos expresados o pagados los portes, no se admitirá reclamación alguna contra el transportista sobre el estado en que se entregó la mercancía." El material que enviamos diariamente desde **Recambios Marinos S.L.U.** a nuestros clientes es examinado antes de empaquetarse para su perfecta integridad y evitar daños en el transporte. Recuerde que es muy importante inspeccionar las cargas en presencia del transportista. Cuando se observen daños en la caja, deberá incluirse en el albarán de entrega del transportista una mención del tipo (CONFORME MERCANCÍA, SALVO INSPECCIÓN), y deberá ser firmada por usted y el transportista. En caso de recibir material defectuoso por estas causas debe hacerlo constar tanto al transportista como a **Recambios Marinos S.L.U.** para poder reclamar a la empresa de transporte correspondiente.

### SOLICITUD DE GARANTÍA

La garantía siempre estará sujeta a la valoración final del departamento técnico de **Recambios Marinos S.L.U.** Esta valoración se llevará a cabo en nuestras instalaciones o en caso necesario por el fabricante del artículo, en ambas opciones el artículo tiene que estar físicamente en nuestras instalaciones centrales de Viladecans. El tiempo para la resolución será un máximo de 30 días naturales desde su recepción.

Para enviar el artículo defectuoso, debe ir a la pagina web [www.recambiosmarinos.es](http://www.recambiosmarinos.es), ir a su cuenta y

seleccionar TRAMITAR GARANTÍA dentro del área privada, desde aquí podrá descargar el archivo para la solicitud de garantías de motores y piezas, y seguir las instrucciones.

**Recambios Marinos S.L.U.** no asumirá ningún préstamo de reemplazo durante el proceso de garantía.

### EXCLUSIONES DE GARANTÍA

**Recambios Marinos S.L.U.** no podrá ser acusado como responsable del defecto ante:

- Desgaste normal del producto.
- Defectos de instalación o uso inadecuado.
- Instalación de un artículo no destinado a ese modelo.
- Daños por causa externa (accidente, rayo, fluctuación de corriente...)
- Defectos y consecuencias relacionadas con el transporte.
- Alteraciones en instalaciones o barcos destinados a la competición.

En caso de rechazo de la garantía, el cliente tiene la posibilidad de recuperar su artículo defectuoso poniéndose en contacto con nosotros vía e-mail solicitando la devolución del mismo dentro de los 7 días naturales siguientes a la fecha en que se le informó del rechazo de garantía.

**Recambios Marinos S.L.U.** no forma parte de las garantías comerciales anunciadas en ocasiones por los fabricantes.

## NORMAS PARA LA DEVOLUCIÓN DE PIEZAS EN STOCK

Con el fin de ayudar a nuestros clientes a mantener un stock correcto, **Recambios Marinos S.L.U.** aceptará la devolución de aquellas piezas que se hayan pedido por error.

No se aceptarán devoluciones de material cuyo importe sea inferior a 30€.

### REQUISITOS FORMALES:

El material a retornar, tiene que estar reflejado en un albarán. Ni el material ni el embalaje deben presentar desperfectos. Bajo ningún concepto se aceptarán devoluciones que no cumplan con alguno de estos puntos. La devolución se tramitará dentro del área privada desde la web [www.recambiosmarinos.es](http://www.recambiosmarinos.es)

### PLAZOS:

El plazo máximo para solicitar la devolución, será de 15 días naturales contados a partir de la fecha de expedición de la mercancía desde nuestras instalaciones. El plazo para la devolución de la mercancía será, como máximo, de 15 días naturales contados a partir de la fecha de recepción del número de pre-autorización de devolución (será notificado automáticamente por **Recambios Marinos S.L.U.** durante el proceso de devolución).

### CONDICIONES:

**Recambios Marinos S.L.U.** , no aceptará bajo ningún concepto la devolución de estos artículos:

- Calzado.
- Material eléctrico.
- Material solicitado por encargo.
- Ánodos, anclas, cadena, mangueras.
- Artículos obsoletos o descatalogados.
- Hélices, neumáticas, Paddle Surf y motores Parsun.
- Aceites, pinturas, grasas , líquidos, incluyendo cualquier producto de limpieza y mantenimiento en general.

### DAÑOS OCASIONADOS POR EL TRANSPORTE:

Se aplicará lo indicado en el artículo 366 de Código de Comercio, que dice: "Dentro de las veinticuatro horas siguientes al recibo de las mercancías, podrá hacerse reclamación contra la empresa de transporte asignada. Transcurridos los términos expresados o pagados los portes, no se admitirá reclamación alguna contra el transportista sobre el estado en que se entregó la mercancía.

El material que enviamos diariamente desde **Recambios Marinos S.L.U.** a nuestros clientes es examinado antes de empaquetarse para su perfecta integridad y evitar daños en el transporte. Recuerde que es muy importante inspeccionar las cargas en presencia del transportista. Cuando se observen daños en la caja, deberá incluirse en el albarán de entrega del transportista una mención del tipo (CONFORME MERCANCÍA, SALVO INSPECCIÓN), y deberá ser firmada por usted y el transportista, en caso de recibir material defectuoso por estas causas debe hacerlo constar tanto al transportista como a **Recambios Marinos S.L.U.** para poder reclamar a la empresa de transporte correspondiente.

Todas las devoluciones de material que previamente hayan sido autorizadas se remitirán a **Recambios Marinos S.L.U.** indicando en el lugar visible el número de devolución.

### ABONOS:

**Recambios Marinos S.L.U.** procederá a abonar todas las devoluciones (que cumplan todos y cada uno de los requisitos formales, plazos y condiciones) por un importe del 90% del facturado originalmente. El 10% restante irá destinado a soportar los costes originados por las devoluciones (manipulación, embalaje, control de calidad...).

### RESERVA DE PROPIEDAD:

**Recambios Marinos S.L.U.** se reserva el derecho de propiedad de todos los materiales que suministre hasta que el comprador haya satisfecho el pago total de los mismos.

## GARANTÍA LIMITADA DE RECAMBIOS MARINOS, S.L.U.

Los productos suministrados por **Recambios Marinos S.L.U.** están garantizados por defectos en el material o fabricación por un periodo de:

- 2 años desde la fecha de compra para productos NUEVOS**
- 1 año para los RECONSTRUIDOS.**

Los productos utilizados con fines comerciales, de alquiler o uso profesional, están garantizados por un periodo de 90 días.

En cualquier caso será imprescindible la presentación de la factura de compra.

**Recambios Marinos S.L.U.** no cubre en garantía y queda al margen de cualquier error de instalación que pudiera ocasionar el concesionario, servicio técnico, mecánico o cliente final. Esta garantía se refiere únicamente a defectos de fabricación y excluye los siguientes casos:

- modificación, desmontaje de las piezas
- ajustes
- desgaste normal
- daños producidos por accidente
- instalación defectuosa o mala manipulación
- mal uso, negligencia
- falta de mantenimiento
- uso de algún accesorio o pieza no vendida por Recambios Marinos
- funcionamiento con gasolina, aceites o lubricantes que no son adecuados para ese tipo de producto (no recomendado).

La responsabilidad de garantía de Recambios Marinos quedará anulada si la pieza está dañada por:

- inundación
- fuego
- tormenta
- cualquier otro elemento climatológico natural
- cuando el número de modelo u otra identificación haya sido alterada, modificada o borrada.

Recambios Marinos no será responsable de ningún cargo por:

- mano de obra
- combustible
- servicios de grúa o rampa
- remolcado
- desplazamiento
- otros gastos indirectos que resulten por causa del fallo del producto, por un defecto del mismo o por una demora razonable en corregir tal defecto.

Estos conceptos no están cubiertos por esta garantía.

Recambios Marinos se reserva el derecho de inspeccionar y determinar si la pieza ha fallado por causa de un defecto de fabricación. No desmonte ninguna pieza. La obligación de Recambios Marinos estará limitada a reparar, reemplazar o abonar el producto una vez se haya identificado como defectuoso a su total discreción. También se reserva el derecho de abonar el importe a su precio de compra, antes que reparar o reemplazar el producto o algún componente del mismo.

Las piezas están cubiertas por esta garantía únicamente en su periodo original. Una vez el periodo de garantía ha expirado, la garantía de cualquier pieza reparada o sustituida expira también. Recambios Marinos podrá quedarse las piezas que considere defectuosas.

Recambios Marinos no garantiza ni se responsabiliza del uso o resultado de utilización del producto en términos de su funcionamiento, fiabilidad, etc. La totalidad del riesgo como resultado y funcionamiento del producto la asume el cliente.

La responsabilidad por cumplimiento de la garantía, estará limitado al precio de compra pagado por el producto.

Ningún concesionario de Recambios Marinos, agente o empleado está autorizado a hacer extensión o modificación alguna de esta política de garantías.

Proceso:

- Se deberá comunicar a Recambios Marinos cualquier defecto de producto que se encuentre dentro del periodo de garantía para obtener inmediatamente el impreso de solicitud de garantía y un número de RGA (expediente de garantía).
- Una vez Recambios Marinos haya recibido la solicitud de garantía y la pieza reclamada con el número de expediente, marcado en el embalaje de la pieza, se procederá a su revisión.
- Si el defecto está cubierto por la garantía, la pieza será reparada o reemplazada.
- Si se precisa reparación, deberán enviar a Recambios Marinos el producto a portes pagados con la prueba de compra.
- Cuando la pieza esté reparada, se devolverá por el sistema de envío determinado por Recambios Marinos.

Puede contactar con el Servicio Técnico de Recambios Marinos en:

**garantias@recmar.es**

Esta garantía comprende única y exclusivamente la garantía relacionada con el producto que le ha suministrado Recambios Marinos. Otras garantías o compromisos efectuados por cualquier persona no autorizada, no son vinculantes para Recambios Marinos a menos que se haya autorizado previamente por escrito.



## RECMAR WARRANTY POLICY

All products sold by **Recambios Marinos S.L.U.** must be installed and used by competent personnel under their exclusive responsibility. **Recambios Marinos S.L.U.** shall not be responsible for the consequences of the faulty or improper installation of any item that does not include installation solutions.

The fitter will be responsible for checking that the manufacturer recommendations have been followed correctly in terms of compatible uses.

Articles sold by **Recambios Marinos S.L.U.** are covered by legal warranty of conformity, in accordance with Royal Legislative Decree 1/2007, of 16 November, approving the recast text of the general law on consumer and user protection.

**Recambios Marinos S.L.U.** distribute the products only to professionals and never to privates of final clients. The cost of installing the part would never be included in the price for which reason, **Recambios Marinos S.L.U.** would never be responsible for its installation.

Articles sold by **Recambios Marinos S.L.U.** are covered by warranty for manufacturing defects for a limited period of time that may vary between 2 years and 3 months, depending on the product, application and type of boat it is installed on (7th/6th/5th list), except for the articles considered consumable, light

bulbs, electrical products, batteries and others that are not covered at all. For information on the exact warranty period of an article, please contact the Sales Department.

In the case of damage caused during shipping, article 366 of the Code of Commerce will apply. The article says: "Claims to the delivery company may be made within 24 hours from receiving the goods. Once this term has elapsed, or the freight costs have been paid, claims to the delivery company with regard to the condition of the goods can no longer be made." The goods that **Recambios Marinos S.L.U.** sends every day to its customers are examined before being packed to ensure their perfect integrity and avoid damage during shipping. Remember that it is essential to check the goods in the presence of the dispatcher. If the package is damaged, the dispatcher's delivery note must mention what type (CONFORMING GOODS, UNLESS INSPECTED), and must be signed by you and by the dispatcher. If you receive damaged goods for these reasons you must notify both the dispatcher and **Recambios Marinos S.L.U.** to be able to make the claim to the relevant delivery company.

### WARRANTY CLAIMS

Warranties are always subject to **Recambios Marinos S.L.U.** Technical Department's assessment. The assessment will be carried out on **Recambios Marinos S.L.U.**'s premises or, if necessary, by the article's manufacturer. In both cases, the article must be physically on **Recambios Marinos S.L.U.**'s premises in Viladecans. Assessment time will not exceed 30 calendar days from receiving the article.

To return the faulty item, visit [www.recambiosmarinos.es](http://www.recambiosmarinos.es), go to your account and select PROCESS WARRANTY in the private section. From there you will be able to download the file to claim the warranty of engines and parts and follow the instructions.

**Recambios Marinos S.L.U.** will not charge for the loan of the replacement during the warranty process.

### WARRANTY EXCLUSIONS

**Recambios Marinos S.L.U.** shall not be responsible for product faults in the following cases:

- Normal wear and tear of a product. Installation faults or improper use.
- Installation of an article not designed for the model in question.
- Damage due to external causes (accidents, lightning, power surges...)
- Defects and consequences of transport.
- Alterations to installations or to boats intended for competitions.

If the warranty is refused, the customer may retrieve the faulty article by contacting **Recambios Marinos S.L.U.** via email and requesting that the article is returned to them within 7 calendar days from the day the warranty was refused.

**Recambios Marinos S.L.U.** does not apply the warranties offered from time to time by manufacturers.

## RETURN POLICY FOR PARTS IN STOCK

To help our customers maintain their stock correctly, **Recambios Marinos S.L.U.** will allow any parts ordered by mistake to be returned.

Goods with a value below €30 may not be returned.

### FORMAL REQUIREMENTS:

Goods returned must be accounted for in a delivery note. Neither the goods nor the packaging must be damaged. Goods that do not meet any of these requirements will not be accepted under any circumstance. Goods may be returned via the private section of the website [www.recambiosmarinos.es](http://www.recambiosmarinos.es)

### TERMS:

Goods must be returned maximum within 15 calendar days from the date the goods were shipped from our premises. The deadline to return goods will be maximum 15 calendar days from the date the return pre-authorisation number is received (it will be automatically provided by **Recambios Marinos S.L.U.** during the return process)

### CONDITIONS:

Under no circumstances will **Recambios Marinos S.L.U.** accept the following articles:

- Footwear.
- Electrical goods.
- Custom-made goods.
- Anodes, anchors, chains, hoses.
- Obsolete or discontinued articles.
- Thrusters, pneumatics, paddle surfing boards and Parsun engines.
- Oils, paints, greases, liquids, including all cleaning and maintenance products in general.

### DAMAGE DURING TRANSPORT:

Article 366 of the Code of Commerce will apply. The article says: "Claims to the delivery company may be made within 24 hours from receiving the goods. Once this term has elapsed, or the freight costs have been paid, claims to the delivery company with regard to the condition of the goods can no longer be made."

The materials that **Recambios Marinos S.L.U.** sends every day to its customers are examined before being packed to ensure their perfect integrity and avoid damage during shipping. Remember that it is essential to check the goods in the presence of the dispatcher. If the package is damaged, the dispatcher's delivery note must mention what type (conforming goods, unless inspected), and must be signed by you and by the dispatcher, if you receive damaged goods for these reasons you must notify both the dispatcher and **Recambios Marinos S.L.U.** to be able to make the claim to the relevant delivery company.

All previously authorised returned goods must be sent to **Recambios Marinos S.L.U.** visibly specifying the return number.

### CREDITING:

**Recambios Marinos S.L.U.** will credit 90% of the amount originally charged of all returned goods (which comply with each and every formal requirement, terms and conditions). 10% is retained to cover the cost of returning the goods (handling, packaging, quality control...).

### RESERVATION OF OWNERSHIP:

**Recambios Marinos S.L.U.** retains ownership of all goods it supplies until the buyer pays for them in full.

## LIMITED WARRANTY OF THE RECAMBIOS MARINOS, S.L. PRODUCTS

The products of **Recambios Marinós S.L.U.** are warranted to be free from manufacturing defects for a period of:

**2 years from the date of purchase for the NEW products**

**1 year for the REBUILT products.**

Products used for commercial, rental or income producing activity are warranted for: 90 days.

In any case it will be essential to present the purchase invoice.

---

**Recambios Marinós S.L.U.** not warrant or make any representations in respect to installation errors made by a servicing dealer, servicing mechanic or the individual. This warranty applies to manufacturing defect only, it does not apply to the following:

- alteration, removal of parts,
- adjustments, tune-up
- damages due to accident
- improper installation or service
- misuse, neglect
- lack of maintenance
- use of any accessory or part not sold by Recambios Marinós
- operation with fuels, oils or lubricants which are not suitable for use with the product.

Recambios Marinós liability under this warranty shall be terminated on any part damaged by:

- flood
- fire
- storm
- other natural acts
- where the model number and other identification has been altered, defaced or removed.

---

Recambios Marinós will not be liable for any charges like:

- labor charges
- fuel
- towing
- ramp
- lift
- trips
- special or indirect damages resulting from the product or caused by the defect or reasonable delay in correcting the defect are not covered.

Recambios Marinós reserves the right to inspect and determine whether or not any part failed due to a manufacturing defect. Do not disassemble any parts. Recambios Marinós reserves the right to credit, refund your purchase price for the product rather than repair or replace the product or any part thereof.

Any part is covered only for the original warranty period. Once the warranty on the product has expired, the warranty on any replaced or repaired part also expires. We shall be allowed to keep parts it deems defective under this warranty.

---

Recambios Marinós does not warrant, guarantee or make any representations regarding the use or the results of the use of the product in terms of its correctness, reliability or otherwise. The entire risk as to the result and performance of the product is assumed by customer.

---

The liability to you for actual damages from any cause, will be limited to the purchase price paid for the product.

---

No Recambios Marinós dealer, agent or employee is authorized to make any modification or extension to this warranty.

---

Process:

- You are required to notify Recambios Marinós any defect within the applicable warranty period and immediately obtain a warranty application and a RGA number (warranty claim number).
- Upon we receive the completed warranty application and part claimed under this warranty with the RGA number marked on the shipping and packing of the part, Recambios Marinós will inspect the part for warranty coverage.
- Only when the defect is covered by the warranty will the part be repaired or replaced.
- If warranty service is required, you must deliver your product at your expense, with proof of purchase.
- When the repair is completed, Recambios Marinós will ship back. Shipping methods will be determined by Recambios Marinós.

You can contact with our warranty department through:

**garantias@recmar.es**

---

This warranty comprises the sole and entire warranty pertaining to the product furnished to you by Recambios Marinós. Any other representations or promises by any person are unauthorized and are not binding upon Recambios Marinós unless in writing.

## POLITICA DI GARANZIE RECMAR

Tutti i prodotti commercializzati da **Recmar S.R.L.** devono essere installati e utilizzati da personale competente sotto la sua esclusiva responsabilità.

**Recmar S.R.L.** non è responsabile per le conseguenze di un'installazione difettosa o inadeguata di qualsiasi articolo che non includa soluzioni di installazione.

L'installatore è responsabile della verifica della corretta applicazione delle raccomandazioni del fabbricante in materia di compatibilità d'uso.

Gli articoli commercializzati dalla **Recmar S.R.L.** sono coperti dalla garanzia legale di conformità, conforme alle condizioni enunciate nel regio decreto legislativo 1/2007 del 16 novembre, approvazione del testo consolidato della legge generale per la difesa dei consumatori e degli utenti.

**Recmar S.R.L.** distribuisce gli articoli presenti nei suoi cataloghi solo a professionisti, mai a privati o cliente finale, l'importo dell'impianto non sarà mai incluso nel prezzo e quindi non sarà responsabile di quest'ultimo.

Gli articoli commercializzati dalla **Recmar S.R.L.** dispongono di una garanzia limitata per difetti di fabbricazione, i periodi possono variare da 2 anni a 3 mesi a seconda del prodotto applicazione e tipo di imbarcazione (elenco 7<sup>a</sup>/ 6<sup>a</sup>/ 5<sup>a</sup>), scartando gli articoli

considerati come consumabili lampadine, prodotti elettrici, batterie e altri che non hanno alcun periodo di tempo, se avete bisogno di conoscere il tempo esatto del prodotto contattare il reparto commerciale.

Per i danni causati al trasporto si applica l'articolo 366 del codice di commercio che recita: "Entro 24 ore dal ricevimento delle merci, può essere presentato un reclamo nei confronti della società di trasporto designata. Alla scadenza dei termini espressi o pagati, non sono ricevibili reclami contro il trasportatore in merito allo stato in cui la merce è stata consegnata."

Il materiale che inviamo quotidianamente da **Recmar S.R.L.** ai nostri clienti viene esaminato prima di essere confezionato per la sua perfetta integrità ed evitare danni al trasporto. Si ricorda che è molto importante ispezionare i colli alla presenza del vettore. In caso di danneggiamento della cassa, sul bollettino di consegna del trasportatore deve figurare un'indicazione del tipo (CONFORME MERCE, SALVO ISPEZIONE) e deve essere firmato dall'utente e dal trasportatore, in caso di ricezione di materiale difettoso per questi motivi deve essere messo a verbale sia al trasportatore che alla **Recmar S.R.L.** per poter reclamare all'impresa di trasporto interessata.

### RICHIESTA DI GARANZIA

La garanzia sarà sempre soggetta alla valutazione finale del Dipartimento Tecnico della **Recmar S.R.L.** Questa valutazione sarà effettuata presso la nostra sede o, se necessario, dal fabbricante dell'articolo, in entrambe le opzioni l'articolo deve essere fisicamente nella nostra sede centrale di Viladecans, il tempo per la risoluzione è un massimo di 30 giorni di calendario dalla ricezione.

Per inviare l'articolo difettoso, è necessario andare al sito [www.recmar.it](http://www.recmar.it), andare al tuo account e selezionare la GARANZIA all'interno del settore privato, da qui è possibile scaricare il file per la richiesta di garanzie di motori e parti e seguire le istruzioni.

**Recmar S.R.L.** non assumerà alcun prestito di sostituzione durante il processo di garanzia.

### ESCLUSIONI DI GARANTÍA

**Recmar S.R.L.** non può essere accusato come responsabile del difetto di fronte a:

- Normale usura di un prodotto.
- Difetti di installazione o uso improprio.
- Installazione di un articolo non destinato a quel modello.
- Danni dovuti a cause esterne (incidente, fulmine, fluttuazione di corrente...)
- Difetti e conseguenze connesse al trasporto.
- Modifiche in impianti o barche destinati alla competizione.

In caso di rifiuto della garanzia, il cliente ha la possibilità di recuperare il suo articolo difettoso contattandoci via e richiesta di rimborso entro 7 giorni di calendario dalla data in cui viene informato del rifiuto della garanzia.

**Recmar S.R.L.** non fa parte delle garanzie commerciali annunciate a volte dai produttori.



## REGOLE PER I RESI MERCE

**Recmar S.R.L.**, accetteranno i resi di merce se preventivamente autorizzati dalla Direzione. Si accetteranno i resi solo degli articoli che sono stati ordinati per errore.

Per errori del magazzino, del catalogo ecc. prego richiedere il modulo attraverso la mail [barbara@recmar.it](mailto:barbara@recmar.it), specificando il motivo.

Non si accetteranno resi di materiale il cui importo sia inferiore a € 30,00

### REQUISITI FORMALI:

La merce da restituire deve essere indicata in un documento di trasporto nel quale vanno trascritti, codici, quantità e descrizione e il riferimento della bolla originale di acquisto.

Il modulo per la richiesta di autorizzazione al reso lo potrà scaricare dal sito [www.recmar.it](http://www.recmar.it) e le verrà fornito un numero di pre-autorizzazione. Una volta compilato, il modulo dovrà essere inviato a [postventa@recmar.es](mailto:postventa@recmar.es), allegando copia della bolla. La mancanza dei requisiti descritti, il reso non potrà essere accettato e verrà restituito al mittente con l'addebito delle spese di trasporto.

### SCADENZE:

Il termine per la richiesta di autorizzazione al reso sarà di 15 giorni a partire dalla data di spedizione della merce e il tempo per la restituzione della merce sarà di 15 giorni a partire dalla data di pre-autorizzazione al reso comunicata dalla **Recmar S.R.L.**

### CONDIZIONI:

**Recmar S.R.L.**, non accetterà resi, qualunque sia il motivo per i seguenti articoli:

- Calzature
- Materiale elettrico
- Materiale su ordinazione extra catalogo
- Anodi, ancore, catene, tubi
- Articoli obsoleti o non più presenti a catalogo
- Eliche, gommoni, paddle surf e motori Parsun
- Olio, vernici, grasso, liquidi, inclusi tutti i prodotti di pulizia e manutenzione in generale.

### DANNI CASUSATI DURANTE IL TRASPORTO:

Si applicheranno le regole indicate dall'art. 366 del Codice del Commercio che recita: Il reclamo contro la Ditta di trasporti può essere fatto entro le ventiquattrore dalla ricezione della merce. Trascorso tale termine, non potrà essere fatto alcun reclamo.

Il materiale che viene spedito giornalmente dalla **Recmar S.R.L.** ai propri clienti, è controllato prima di essere impacchettato al fine di preservarne la sua integrità ed evitare danni durante il trasporto. Si prega di controllare sempre l'integrità delle scatole e nel caso in cui ci siano dei danni esteriori, si prega di accettare sempre con riserva e di firmare unitamente al corriere la copia della bolla di consegna e trattenere una copia. Una copia di tutto va poi inviata alla **Recmar S.R.L.** per poterla inoltrare alla Ditta di Trasporti corrispondente.

Tutti resi di materiale preventivamente autorizzato, dovranno essere spediti alla **Recmar S.R.L.** in porto franco entro i termini concordati includendo la copia della bolla e la richiesta di reso accettata.

### NOTE DI CREDITO:

**Recmar S.R.L.**, procederà alla emissione delle note di credito per tutti quei resi che abbiano i requisiti formali precedentemente indicati per il 90% del valore originario. Il restante 10% verrà trattenuto a copertura dei costi di movimentazione, imballaggio, controllo qualità etc.

### RISERVA DI PROPRIETÀ:

**Recmar S.R.L.** si riserva il diritto di proprietà di tutto il materiale venduto fino al pagamento totale delle relative fatture.

## GARANZIA LIMITATA DI RECAMBIOS MARINOS, S.L.

I prodotti forniti da **Recambios Marinus S.L.U.** sono garantiti contro i difetti di materiale o di lavorazione per un periodo di:

**2 anni dalla data di acquisto per prodotti del tutto NUOVI**

**1 anno per i RIGENERATI.**

I prodotti utilizzati per finalità commerciali, il noleggio o uso aziendale, sono garantiti per un periodo di: 90 giorni.

Solo saranno coperti dalla garanzia i clienti che possono fornire la prova di acquisto della Recambios Marinus.

**Recambios Marinus S.L.U.** non copre in garanzia e rimane al margine di eventuali errori di installazione che potrebbero causare il concessionario, il servizio meccanico o il cliente finale. Questa garanzia copre solo i difetti di fabbricazione ed esclude i seguenti casi:

- modifica, smontaggio di parti
- rettifiche
- la normale usura
- danni accidentali
- un'installazione difettosa o uso improprio
- abuso, negligenza
- mancanza di manutenzione
- l'uso di qualsiasi accessori o componenti non venduti dalla Recambios Marinus
- da benzina, olio e lubrificanti che non sono adatti a questo tipo di prodotto (non raccomandato).

La responsabilità di garanzia della Recambios Marinus sarà se l'articolo è danneggiato dalle:

- inondazioni,
- incendi,
- tempeste,
- o elemento naturale climatico,
- o se il numero di modello o altro tipo di identificazione è stato alterato, modificato o cancelato.

Recambios Marinus non sarà responsabile di tutte le spese per:

- la manodopera,
- i servizi di carburante,
- gru o rampe,
- traino,
- viaggio,
- altri costi indiretti dovuti a causa di guasto del prodotto, un difetto dello stesso o di un termine ragionevole per correggere questo difetto.

Questi concetti non sono coperti da questa garanzia.

Recambios Marinus si riserva il diritto di ispezionare e determinare se la parte si è guastata a causa di un difetto di fabbricazione. Non smontare nessun pezzo. L'obbligo di Recambios Marinus è limitato a riparare, sostituire o rimborsare il prodotto una volta che è stato identificato come difettoso a sua unica discrezione. Si riserva altresì il diritto di pagare il prezzo di acquisto, piuttosto che riparare o sostituire il prodotto o qualsiasi componente. I pezzi sono coperti di garanzia solo per il suo periodo originale. Una volta che il periodo di garanzia è scaduto, la garanzia su tutte le parti soggette a manutenzione automaticamente scade. Recambios Marinus può tenersi i pezzi che consideri difettosi secondo la politica di garanzia.

Recambios Marinus non garantisce né si responsabilizza dell'uso o ai risultati di utilizzo del prodotto in termini di prestazioni, affidabilità, ecc. L'intero rischio come risultato e le prestazioni del prodotto, è a carico del cliente.

La responsabilità della Recambios Marinus verso il cliente per il compimento della garanzia, sarà limitata al prezzo di acquisto pagato per il prodotto.

Nessun rivenditore della Recambios Marinus, agente o dipendente è autorizzato ad apportare qualsiasi modifica o estensione di questa polizza di garanzia.

Processo:

- Deve comunicare alla Recambios Marinus qualsiasi difetto di prodotto che si trova dentro del periodo di garanzia alla Recambios Marinus per ottenere immediatamente l'impresso di sollecito di garanzia e un numero di RGA (numero di garanzia).
- Una volta Recambios Marinus ha ricevuto la richiesta di garanzia e il pezzo reclamato con il numero di file RGA e l'imballo originale Recambios Marinus procederà alla sua ispezione.
- Solo se il difetto entra in garanzia, il pezzo verrà riparato o sostituito, a discrezione della Recambios Marinus.
- In caso si richieda la riparazione, bisognerà inviare il prodotto alla Recambios Marinus utilizzando il nostro corriere prepagato con la prova di acquisto.
- Quando il materiale viene riparato, verrà rispedito all'indirizzo che avrà indicato. Il sistema di invio sarà determinato dalla Recambios Marinus.

È possibile contattare il nostro servizio tecnico della Recambios Marinus attraverso la mail:

**garantias@recmar.es**

Tale garanzia comprende solo ed esclusivamente la garanzia relazionata con il prodotto che ha somministrato la Recambios Marinus. Altre garanzie o impegni assunti da qualsiasi altra persona non autorizzata, non sono vincolanti per la Recambios Marinus a meno di previa autorizzazione scritta.

## POLITIQUE DE GARANTIE RECMAR

Tous les produits vendus par **Recambios Marinos S.L.U.** doivent être installés et utilisés par du personnel compétent sous sa seule responsabilité.

**Recambios Marinos S.L.U.** n'est pas responsable des conséquences d'une installation défectueuse ou inappropriée de tout élément n'incluant pas les solutions d'installation.

L'installateur sera responsable de la vérification de l'application correcte des recommandations du fabricant concernant la compatibilité d'utilisation.

Les articles vendus par **Recambios Marinos S.L.U.** bénéficient de la garantie légale de conformité, conformément aux conditions énoncées dans le décret législatif royal 1/2007 du 16 novembre, portant approbation du texte consolidé de la loi générale de la défense des consommateurs et des utilisateurs.

Les articles vendus par **Recambios Marinos S.L.U.** ont une garantie limitée pour les défauts de fabrication, les périodes peuvent varier de 2 ans à 3 mois en fonction de l'application du produit et du type de navire où ils ont été installés (7ème / 6ème / 5ème liste), excluant les articles considérés comme des consommables, ampoules, produits électriques, batteries et autres.

Si vous ne connaissez pas la durée de garantie exacte du produit, contactez le service commercial.

Pour les dommages causés au cours du transport, les dispositions de l'article 366 du code de commerce seront appliquées, ce qui stipule:

Vingt-quatre heures maximum après la réception de la marchandise, une réclamation doit être adressée à la société de transport.

Après que les conditions aient été exprimées ou que le fret eu été payé, aucune réclamation ne sera acceptée contre le transporteur auprès de l'État.

Lorsque la marchandise a été livrée. Le matériel que nous envoyons quotidiennement de **Recambios Marinos S.L.U.** à nos clients est examiné avant l'emballage pour une intégrité parfaite et éviter les dommages de transport. N'oubliez pas qu'il est très important d'inspecter le chargement en présence du transporteur.

Lorsque des dommages sont constatés sur le colis, ils doivent figurer sur le bon de livraison du transporteur.

Une mention du type (EN FONCTION DE LA MARCHANDISE, SAUF INSPECTION), et doit être signé par vous et le transporteur, s'il est reçu défectueux le matériel doit être enregistré pour ces raisons à la fois par le transporteur et par **Recambios Marinos S.L.U.** pour qu'une réclamation soit faite la compagnie de transport correspondante.

### DEMANDE DE GARANTIE

La garantie sera toujours soumise à l'évaluation finale du service technique de **Recambios Marinos S.L.U.** Cette évaluation sera effectuée dans nos installations ou, si nécessaire, par le fabricant de l'article, dans les deux cas, l'article doit être physiquement dans nos locaux de Viladecans, le délai de résolution sera de 30 jours maximum à partir de sa réception.

Pour envoyer l'article défectueux, vous devez vous rendre sur le site [www.recambiosmarinos.es](http://www.recambiosmarinos.es), accéder à votre compte et sélectionner PIECES DE RETOUR.

Dans l'espace privé, vous pouvez télécharger le fichier pour demander des garanties de moteurs et de pièces et suivre les instructions.

Si tel est votre souhait, **Recambios Marinos S.L.U.** n'assumera aucun prêt de remplacement pendant le processus de garantie.

### EXCLUSIONS DE GARANTIE

**Recambios Marinos S.L.U.** ne sera pas responsable des défauts suivants:

- Usure normale d'un produit.
- Défauts d'installation ou d'utilisation inadéquate.
- Installation d'un article non destiné à ce modèle.
- Dommages dus à une cause externe (accident, foudre, fluctuation de courant...)
- Défauts et conséquences liés au transport.
- Modifications d'installations ou de bateaux destinés à la compétition.

En cas de refus de la garantie, le client a la possibilité de récupérer son article défectueux en nous contactant par courrier électronique pour demander le retour à ses frais de celui-ci dans les 7 jours calendaires suivant la date à laquelle vous avez été informé du rejet de la garantie.

**Recambios Marinos S.L.U.** ne participe pas à des garanties commerciales parfois annoncées par les fabricants.

## RÈGLES POUR LE RETOUR DE PIÈCES EN STOCK

Afin d'aider nos clients à maintenir un stock correct, **Recambios Marinos S.L.U.** acceptera les retours des pièces commandées par erreur. Les retours de matériel dont le montant est inférieur à 30 € ne seront pas acceptés.

### EXIGENCES FORMELLES:

Le matériel à retourner doit être apparaître dans un bon de livraison ou une facture.

Ni le matériel ni l'emballage ne doivent présenter de dommage. Aucun retour ne sera accepté qui ne respecte aucun de ces points. Le remboursement sera traité dans l'espace privé à partir du site Web [www.recambiosmarinos.es](http://www.recambiosmarinos.es)

### DÉLAIS:

Le délai maximum pour demander le retour sera de 15 jours calendaires à compter de la date d'envoi de la marchandise de nos installations. La période pour le retour de la marchandise sera au maximum de 15 jours à compter de la date de réception du numéro d'autorisation de retour (vous serez informé automatiquement par **Recambios Marinos S.L.U.** au cours du processus de retour)

### CONDITIONS:

**Recambios Marinos S.L.U.**, n'acceptera en aucun cas le retour de ces articles:

- Chaussures.
- Matériel électrique.
- Matériel commandé sur demande.
- Anodes, ancrs, chaîne, tuyaux.
- Les articles obsolètes ou abandonnés.
- Hélices, pneumatiques, blocs moteurs, Paddle, Surf et moteurs Parsun.
- Huiles, peintures, graisses, liquides, y compris les produits de nettoyage et d'entretien en général.

### DOMMAGES CAUSÉS PAR LE TRANSPORT:

Les dispositions de l'article 366 du Code de commerce seront appliquées, qui stipule: «Dans les vingt-quatre heures après la réception de la marchandise, une réclamation doit être faite à la compagnie de transport assignée.

Une fois que les conditions ont été exprimées ou que le fret est payé, aucune réclamation ne sera acceptée contre le transporteur sur l'état dans lequel les marchandises ont été livrées.

Le matériel que nous envoyons chaque jour de **Recambios Marinos S.L.U.** à nos clients est examiné avant d'être emballé pour une intégrité parfaite et éviter les dommages de transport. Rappelez-vous qu'il est très important d'inspecter les colis en présence du transporteur. Lorsque des dommages sur le colis sont observés, vous devez noter une mention du type (selon la marchandise, sauf inspection), et doit être signé par vous et le transporteur, s'il est reçu défectueux le matériel doit être enregistré pour ces raisons à la fois par le transporteur et par **Recambios Marinos S.L.U.** pour qu'une réclamation soit faite la compagnie de transport correspondante.

Tous les retours de matériel préalablement autorisés seront envoyés à **Recambios Marinos S.L.U.** indiquant à l'endroit visible le numéro de retour.

### ABONNEMENTS:

**Recambios Marinos S.L.U.** procédera au paiement de toutes les déclarations (qui respectent chacune des conditions de forme, modalités et conditions) pour un montant égal à 90% de la facture originale. Les 10% restants seront destinés à supporter les coûts occasionnés par les retours (manutention, emballage, contrôle de qualité...).

### RESERVE DE PROPRIETE:

**Recambios Marinos S.L.U.** se réserve le droit de disposer de tout le matériel fourni jusqu'à concurrence du paiement intégral par l'acheteur, le transfert de leur propriété ne pouvant intervenir avant cette échéance.



## GARANTIE LIMITÉE DE RECAMBIOS MARINOS, S.L.U.

Les produits fournis par Recambios Marinos S.L.U. sont garantis contre tout défaut de matériel ou de fabrication pendant une période de :

**2 ans à compter de la date d'achat pour les produits NEUFS.**

**1 an pour les produits REBUILTÉS.**

Les produits utilisés à des fins commerciales, locatives ou professionnelles sont garantis pendant une période de 90 jours.

Dans tous les cas, il est indispensable de présenter la facture d'achat.

**Recambios Marinos S.L.U.** ne couvre pas la garantie et n'est pas responsable des erreurs d'installation qui peuvent être causées par le revendeur, le service technique, le mécanicien ou le client final. Cette garantie ne concerne que les défauts de fabrication et exclut les cas suivants :

- modification, démontage de pièces
- ajustements
- l'usure normale
- dommages causés par un accident
- installation défectueuse ou mauvaise manipulation
- mauvaise utilisation, négligence
- manque d'entretien
- l'utilisation d'un accessoire ou d'une pièce non vendue par Recambios Marinos
- l'utilisation d'essence, d'huiles ou de lubrifiants non adaptés à ce type de produit (déconseillés).

La responsabilité de Recambios Marinos en matière de garantie est annulée si la pièce est endommagée par :

- inondation
- incendie
- tempête
- tout autre élément météorologique naturel
- lorsque le numéro de modèle ou toute autre identification a été altéré, modifié ou oblitéré.

Recambios Marinos ne sera pas responsable des frais de :

- la main-d'œuvre
- le carburant
- les services de remorquage ou de rampe
- remorquage
- les déplacements
- autres coûts indirects résultant de la défaillance du produit, d'un défaut du produit ou d'un retard raisonnable dans la correction de ce défaut.

Ces éléments ne sont pas couverts par la présente garantie.

Recambios Marinos se réserve le droit d'inspecter et de déterminer si la pièce est défectueuse en raison d'un défaut de fabrication. Ne démontez aucune pièce. L'obligation de Recambios Marinos se limitera à réparer, remplacer ou créditer le produit une fois qu'il aura été identifié comme défectueux, à sa seule discrétion. Recambios Marinos se réserve également le droit de créditer le montant du prix d'achat, plutôt que de réparer ou de remplacer le produit ou toute partie de celui-ci.

Les pièces ne sont couvertes par cette garantie que pendant la période de garantie initiale. Une fois la période de garantie expirée, la garantie sur les pièces réparées ou remplacées expire également. Recambios Marinos peut conserver les pièces qu'il considère comme défectueuses.

Recambios Marinos ne garantit pas et n'est pas responsable de l'utilisation ou du résultat de l'utilisation du produit en termes de performance, de fiabilité, etc. L'intégralité du risque lié au résultat et à la performance du produit est assumée par le client.

La responsabilité pour l'exécution de la garantie est limitée au prix d'achat payé pour le produit.

Aucun revendeur, agent ou employé de Recambios Marinos n'est pas autorisé à étendre ou à modifier cette politique de garantie.

Procédure :

- Recambios Marinos doit être informé de tout défaut du produit qui entre dans la période de garantie afin d'obtenir immédiatement le formulaire de demande de garantie et un numéro RGA (dossier de garantie).
- Une fois que Recambios Marinos a reçu la demande de garantie et la pièce réclamée avec le numéro de dossier, marqué sur l'emballage de la pièce, il procédera à son examen.
- Si le défaut est couvert par la garantie, la pièce sera réparée ou remplacée.
- Si une réparation est nécessaire, le produit doit être envoyé à Recambios Marinos en port payé avec la preuve d'achat.
- Une fois la pièce réparée, elle sera renvoyée par le système d'expédition déterminé par Recambios Marinos.

Vous pouvez contacter le service technique de Recambios Marinos à l'adresse suivante

**garantias@recmar.es**

Cette garantie couvre uniquement et exclusivement la garantie liée au produit qui vous a été fourni par Recambios Marinos. Les autres garanties ou engagements pris par une personne non autorisée ne sont pas contraignants pour Recambios Marinos, sauf autorisation écrite préalable.





## BARCELONA

Jocelyn Bell, 26  
Pol. Ca n'Alemany  
08840 Viladecans (Barcelona)  
Tel. 900 841 013 - 93 633 34 80  
Fax 93 662 66 59

International  
phone: (+34) 93 662 66 55  
Fax (+34) 93 662 66 59

[info@recambiosmarinos.es](mailto:info@recambiosmarinos.es)  
[www.recambiosmarinos.es](http://www.recambiosmarinos.es)

## GIRONA

C/ Gironés, 5  
Pol. Ind. El Plà  
17486 Castelló d'Empúries (Girona)  
Tel. (+34) 972 158 809

[girona@recmar.es](mailto:girona@recmar.es)

## CANARIAS

Laura Grote de la Puerta, 3, Nave 5  
Pol. Industrial El Mayorazgo  
38110 Santa Cruz de Tenerife  
Tel. (+34) 922 621 499

[canarias@recmar.es](mailto:canarias@recmar.es)

## ITALIA

RECMAR SRL  
Via Israele 10 H  
Zona Industriale Settore 7  
07026 Olbia (OT)

Tel. (+39) 0789 51962  
Fax (+39) 0789 600177  
[sales@recmar.it](mailto:sales@recmar.it)